

X12型 X12 TYPE

圓、方鍍紋式
Square/Round snap-fastener and screw

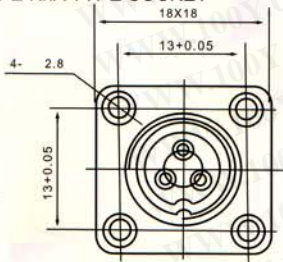

X12型 KnA型插座
X12 TYPE KnA TYPE SOCKET



X12型 KnL型插座
X12 TYPE KnL TYPE SOCKET

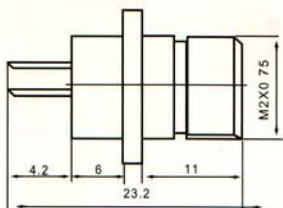
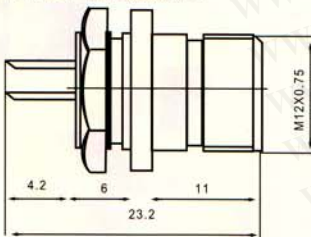

使用环境条件:

系列: 2芯 3芯 4芯 5芯 6芯 7芯
环境温度: -55~+100°C
相对湿度: 温度为+40°C时达到98%
振动: 10~2000HZ
冲击: 490m/s²

主要技术条件:

工作电流/电压: 3A / 300V
接触电阻: < 10MΩ
耐压: 1000V
绝缘电阻: > 5000MΩ
寿命: 500次

Working Condition

Series: 2core 3core 4core 5core 6core 7core
Environmental temperature: -55~+100°C
Relative humidity: 98%, +400°C
Vibration: 10~2000HZ
Impact: 490m/s²

Major technical condition

Working current/voltage: 3A/300V
Contact resistance: < 10MΩ
Withstand Voltage: 1000V
Insulation resistance: > 5000MΩ
Life: 500 times

X12型 KnP型插座
X12 TYPE KnP TYPE SOCKET

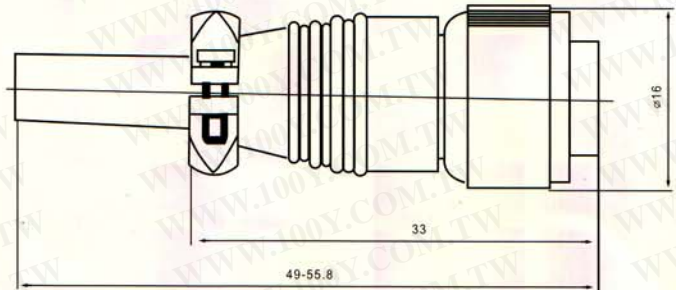

勝特力材料 886-3-5753170
勝特力电子(上海) 86-21-54151736
勝特力电子(深圳) 86-755-83298787
[Http://www.100y.com.tw](http://www.100y.com.tw)

X12型外型尺寸:

● 连接器

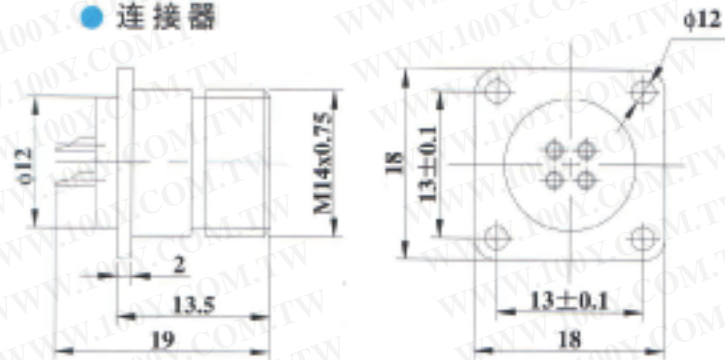

● 插头 X12K-J4P

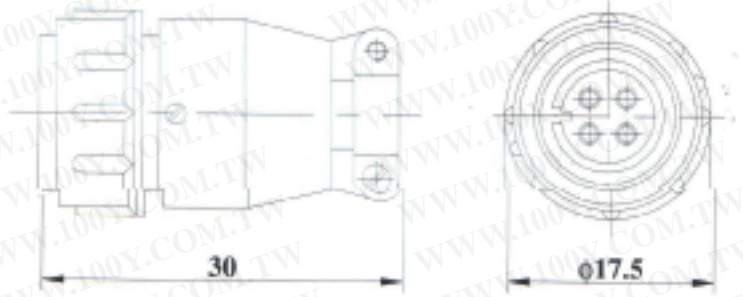

● 插头 X12K-J4A

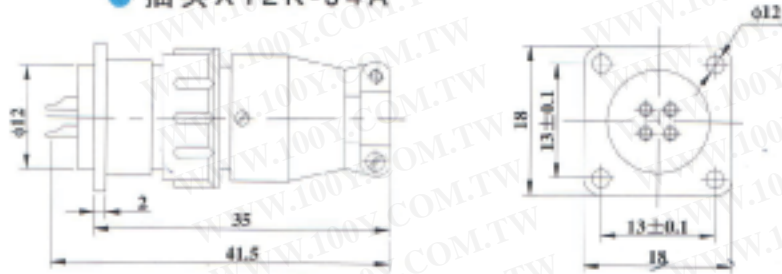

● 安装开孔

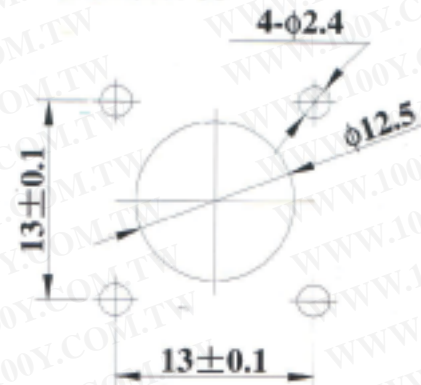

芯 数	3芯	4芯	5芯
排 列 图			
额定电流A	3	3	3
接触对直径、数量	$\phi 1 \times 3$	$\phi 1 \times 4$	$\phi 1 \times 5$
工作电压 (AC.V.rms)	500	500	500
耐压 (AC.V) 1min	1000	1000	1000
接触电阻mΩ	<5mΩ	<5mΩ	<5mΩ
绝缘电阻MΩ	>500MΩ	>500MΩ	>500MΩ



勝特力材料 886-3-5753170
 勝特力电子(上海) 86-21-54151736
 勝特力电子(深圳) 86-755-83298787
[Http://www.100y.com.tw](http://www.100y.com.tw)