

勝特力材料 886-3-5753170  
 勝特力电子(上海) 86-21-54151736  
 勝特力电子(深圳) 86-755-83298787  
[Http://www.100y.com.tw](http://www.100y.com.tw)

# UTC431

# LINEAR INTEGRATED CIRCUIT

## PROGRAMMABLE PRECISION REFERENCE

### DESCRIPTION

The UTC431 is three-terminal adjustable regulator with a guaranteed thermal stability over applicable temperature ranges. The output Voltage may be set to any value between  $V_{ref}$  (approximately 2.5V) and 26 V with two external resistors. These devices provide a very sharp turn-on characteristic, making these devices excellent replacement for zener diodes in many applications.

### FEATURE

- \*Programmable output Voltage to 36V
- \*Low dynamic output impedance  $0.2\Omega$
- \*Sink current capability of 1.0 to 100mA
- \*Equivalent full-range temperature coefficient of 50ppm/°C typical
- \*Temperature compensated for operation over full rated operating temperature range
- \*Low output noise voltage
- \*Fast turn on response

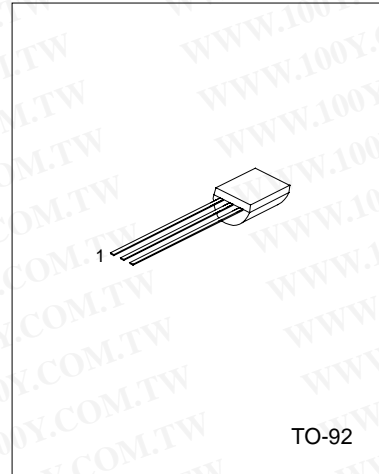

1:Ref; 2:Anode; 3:Cathode

### BLOCK DIAGRAM

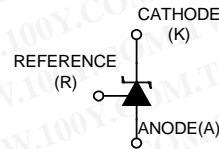
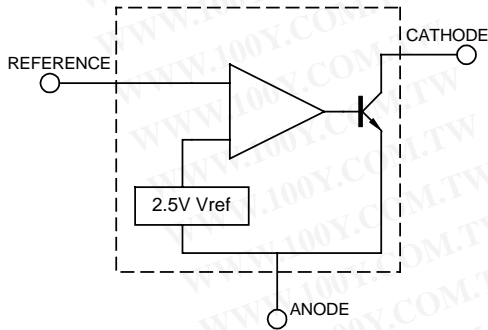

勝特力材料 886-3-5753170  
 勝特力电子(上海) 86-21-54151736  
 勝特力电子(深圳) 86-755-83298787  
[Http://www.100y.com.tw](http://www.100y.com.tw)

## UTC431

## LINEAR INTEGRATED CIRCUIT

### ABSOLUTE MAXIMUM RATINGS (Operating temperature range applies unless otherwise specified)

CHARACTERISTICS	SYMBOL	VALUE	UNITS
Cathode Voltage	V <sub>KA</sub>	37	V
Cathode Current Range(Continuous)	I <sub>KA</sub>	-100~+150	mA
Reference Input Current Range	I <sub>ref</sub>	0.05~+10	mA
Power Dissipation	P <sub>D</sub>		
D,Z Suffix Package		770	mW
N Suffix Package		1000	mW
Operating temperature	T <sub>opr</sub>	0~70	°C
Storage temperature Temperature	T <sub>stg</sub>	-65~+150 °C	°C

### RECOMMENDED OPERATING CONDITIONS

Characteristic	Symbol	Min	Typ	Max	Unit
Cathode Voltage	V <sub>KA</sub>	V <sub>REF</sub>		36	V
Cathode Current	I <sub>KA</sub>	1.0		100	mA

### ELECTRICAL CHARACTERISTICS(T<sub>a</sub>=25°C, unless otherwise specified)

Characteristic	Symbol	Test conditions	MIN	TYP	MAX	UNIT
Reference Input Voltage	V <sub>ref</sub>	V <sub>KA</sub> =V <sub>REF</sub> , I <sub>KA</sub> =10mA	2.440	2.495	2.550	V
Deviation of reference Input Voltage Over temperature(note 1)	ΔV <sub>ref</sub> /ΔT	V <sub>KA</sub> =V <sub>REF</sub> , I <sub>KA</sub> =10mA T <sub>MIN</sub> ≤T <sub>A</sub> ≤T <sub>MAX</sub>		4.5	17	mV
Ratio of Change in Reference Input Voltage to the Change in Cathode Voltage	ΔV <sub>ref</sub> /ΔV <sub>KA</sub>	I <sub>KA</sub> =10mA    ΔV <sub>KA</sub> =10V~V <sub>REF</sub>		-1.0	-2.7	mV/V
		ΔV <sub>KA</sub> =36V~10V		-0.5	-2.0	
Reference Input Current	I <sub>ref</sub>	I <sub>KA</sub> =10mA, R <sub>1</sub> =10kΩ, R <sub>2</sub> =∞		1.5	4	μA
Deviation of Reference Input Current Over Full Temperature Range	ΔI <sub>ref</sub> /ΔT	I <sub>KA</sub> =10mA, R <sub>1</sub> =10kΩ, R <sub>2</sub> =∞, T <sub>A</sub> =full Temperature		0.4	1.2	μA
Minimum cathode current for regulation	I <sub>KA</sub> (min)	V <sub>KA</sub> =V <sub>REF</sub>		0.45	1.0	mA
Off-state cathode Current	I <sub>KA</sub> (OFF)	V <sub>KA</sub> =36V, V <sub>REF</sub> =0		0.05	1.0	μA
Dynamic Impedance	Z <sub>KA</sub>	V <sub>KA</sub> =V <sub>REF</sub> , I <sub>KA</sub> =1 to 100mA f≤1.0kHz		0.15	0.5	Ω

Note: T<sub>MIN</sub>=0°C, T<sub>MAX</sub>=+70°C

勝特力材料 886-3-5753170  
 勝特力电子(上海) 86-21-54151736  
 勝特力电子(深圳) 86-755-83298787  
[Http://www.100y.com.tw](http://www.100y.com.tw)

# UTC431

# LINEAR INTEGRATED CIRCUIT

## TEST CIRCUITS

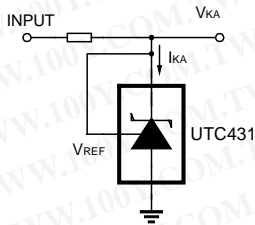

Fig 7 Test Circuit For  $V_{KA}=V_{REF}$

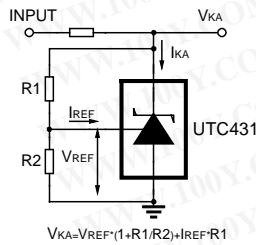

Fig 8 Test Circuit for  $V_{KA} \geq V_{REF}$

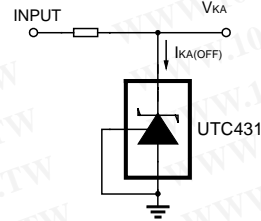

Fig 9 Test Circuit For  $I_{KA(OFF)}$

$$V_{KA} = V_{REF} \cdot (1 + R1/R2) + I_{REF} \cdot R1$$

## TYPICAL APPLICATION

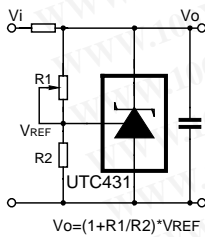

Fig 10 Shutdown Regulator

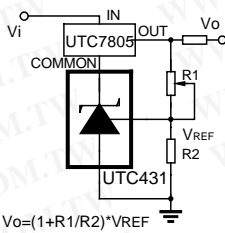

Fig 11 Output Control of a Three-Terminal Fixed Regulator

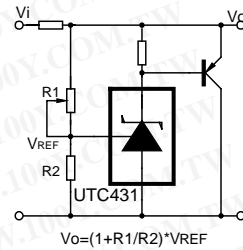

Fig 12 Higher-current Shunt Regulator

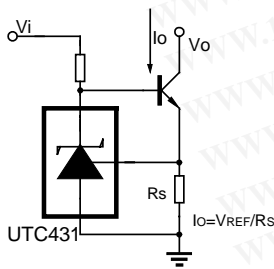

Fig 13 Constant-current Sink

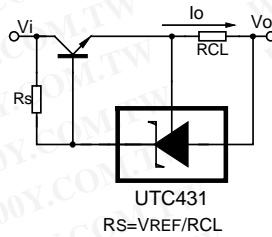

Fig 14 Current Limiting or Current Source

勝特力材料 886-3-5753170  
 勝特力电子(上海) 86-21-54151736  
 勝特力电子(深圳) 86-755-83298787  
[Http://www.100y.com.tw](http://www.100y.com.tw)

# UTC431

# LINEAR INTEGRATED CIRCUIT

## TYPICAL PERFORMANCE CHARACTERISTICS

Fig 1 Cathode Current Vs Cathode Voltage

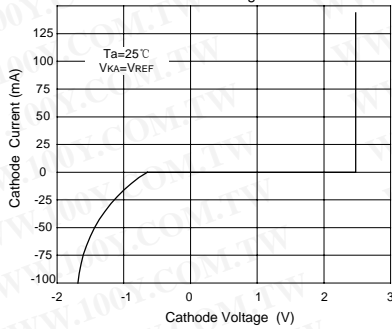

Fig 2 Cathode Current Vs Cathode Voltage

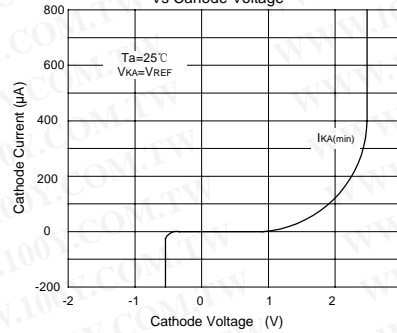

Fig 3 Change in Reference Input Voltage Vs Cathode voltage

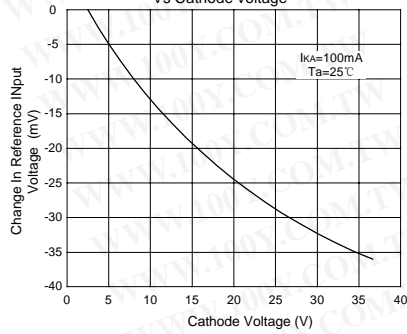

Fig 4 Pulse Response

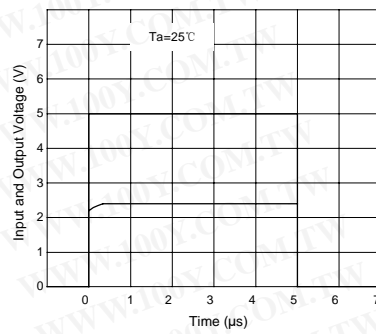

Fig 5 Dynamic Impedance Vs Frequency

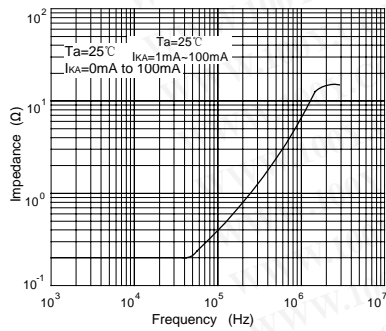

Fig 6 Small Signal Voltage Amplification Vs Frequency

