

TOSHIBA PHOTOCOUPLER GaAs IRED & PHOTO-TRANSISTOR

TLP621, TLP621-2, TLP621-4

PROGRAMMABLE CONTROLLER
AC / DC - INPUT MODULE
SOLID STATE RELAY

Unit in mm

The TOSHIBA TLP621, -2, and -4 consists of a photo-transistor optically coupled to a gallium arsenide infrared emitting diode. The TLP621-2 offers two isolated channels in an eight lead plastic DIP, which the TLP621-4 provides four isolated channels in a sixteen plastic DIP.

- Collector-Emitter Voltage : 55V (Min.)
- Current Transfer Ratio : 50% (Min.)
- Rank GB : 100% (Min.)

PIN CONFIGURATIONS (TOP VIEW)

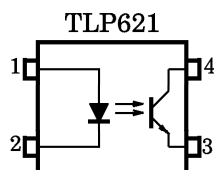

1 : ANODE
2 : CATHODE
3 : EMITTER
4 : COLLECTOR

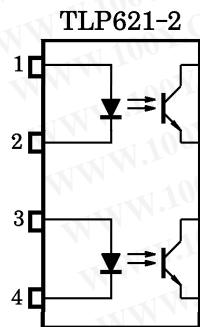

1, 3 : ANODE
2, 4 : CATHODE
5, 7 : EMITTER
6, 8 : COLLECTOR

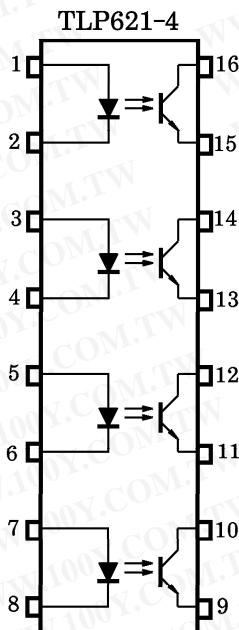

1, 3, 5, 7 : ANODE
2, 4, 6, 8 : CATHODE
9, 11, 13, 15 : EMITTER
10, 12, 14, 16 : COLLECTOR

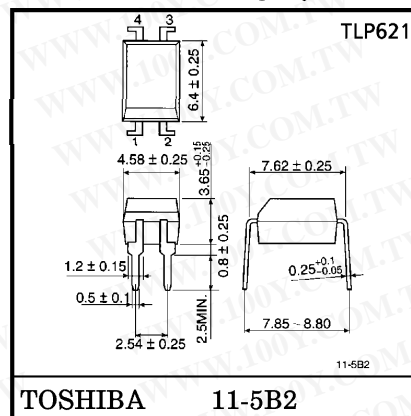

TOSHIBA 11-5B2

Weight : 0.26g

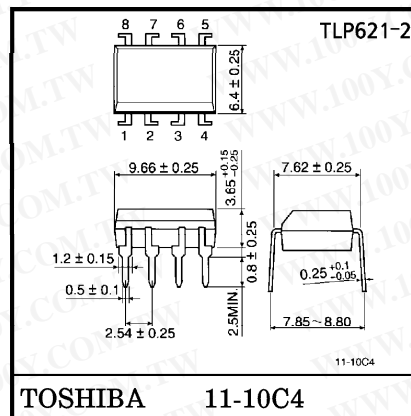

TOSHIBA 11-10C4

Weight : 0.54g

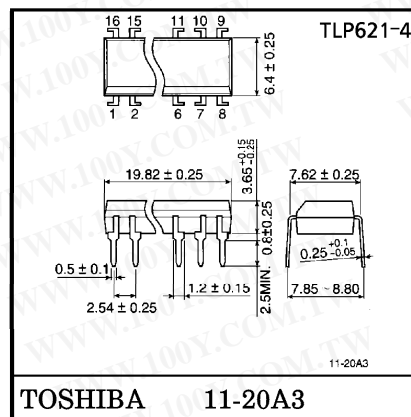

TOSHIBA 11-20A3

Weight : 1.1g

勝特力材料 886-3-5753170
 勝特力电子(上海) 86-21-54151736
 勝特力电子(深圳) 86-755-83298787
[Http://www.100y.com.tw](http://www.100y.com.tw)

勝特力材料 886-3-5753170
 勝特力电子(上海) 86-21-54151736
 勝特力电子(深圳) 86-755-83298787
[Http://www.100y.com.tw](http://www.100y.com.tw)

● Current Transfer Ratio

TYPE	CLASSIFICATION *1	CURRENT TRANSFER RATIO (%) (I_C / I_F)		MARKING OF CLASSIFICATION
		$I_F = 5\text{mA}, V_{CE} = 5\text{V}, T_a = 25^\circ\text{C}$		
		MIN.	MAX.	
TLP621	(None)	50	600	BLANK, Y, Y [■] , G, G [■] , B, B [■] , GB
	Rank Y	50	150	Y, Y [■]
	Rank GR	100	300	G, G [■]
	Rank BL	200	600	B, B [■]
	Rank GB	100	600	G, G [■] , B, B [■] , GB
TLP621-2	(None)	50	600	BLANK, GR, BL, GB
TLP621-4	Rank GB	100	600	GR, BL, GB

*1 : Ex. Rank GB : TLP621 (GB)

(Note) Application type name for certification test, please use standard product type name, i.e.

TLP621 (GB) : TLP621
 TLP621-2 (GB) : TLP621-2

	MADE IN JAPAN	MADE IN THAILAND
UL Recognized	E67349 *2	E152349 *2
BSI Approved	6508, 7445 *3	6505, 7445 *3
SEMKO Approved	9735090/01 *4	—

*2 UL1577

*3 BS EN60065 : 1994, BS EN60950 : 1992

*4 EN60950 (Approved is TLP621 only)

勝特力材料 886-3-5753170
勝特力电子(上海) 86-21-54151736
勝特力电子(深圳) 86-755-83298787
[Http://www.100y.com.tw](http://www.100y.com.tw)

- Option (D4) type
VDE Approved : DIN VDE0884/06.92, Certificate No. 68384
Maximum Operating Insulation Voltage : 890V_{PK}
Highest Permissible Over Voltage : 8000V_{PK}

(Note) When a VIDE0884 approved type is needed, please disignate the “Option (D4)”

	7.62mm pich standard type	10.16mm pich (LF2) type
● Creepage Distance	: 6.4mm (Min.)	8.0mm (Min)
Clearance	: 6.4mm (Min.)	8.0mm (Min)
Insulation Thickness	: 0.4mm (Min.)	0.4mm (Min)

勝特力材料 886-3-5753170
 勝特力电子(上海) 86-21-54151736
 勝特力电子(深圳) 86-755-83298787
[Http://www.100y.com.tw](http://www.100y.com.tw)

MAXIMUM RATINGS (Ta = 25°C)

CHARACTERISTIC	SYMBOL	RATING		UNIT	
		TLP621	TLP621-2 TLP621-4		
LED	Forward Current	I _F	60	50	mA
	Forward Current Derating	ΔI _F /°C	-0.7 (Ta > 39°C)	-0.5 (Ta = 25°C)	mA/°C
	Pulse Forward Current	I _{FP}	1 (100μs pulse, 100pps)		A
	Power Dissipation	P _D	100	70	mW
	Power Dissipation Derating	ΔP _D /°C	-1.0	-0.7	mW/°C
	Reverse Voltage	V _R	5		V
	Junction Temperature	T _j	125		°C
DETECTOR	Collector-Emitter Voltage	V _{CEO}	55		V
	Emitter-Collector Voltage	V _{ECO}	7		V
	Collector Current	I _C	50		mA
	Collector Power Dissipation (1 Circuit)	P _C	150	100	mW
	Collector Power Dissipation Derating (1 Circuit, Ta ≥ 25°C)	ΔP _C /°C	-1.5	-1.0	mW/°C
	Junction Temperature	T _j	125		°C
Storage Temperature Range	T _{stg}	-55~125		°C	
Operating Temperature Range	T _{opr}	-55~100		°C	
Lead Soldering Temperature	T _{sol}	260 (10s)		°C	
Total Package Power Dissipation	P _T	250	150	mW	
Total Package Power Dissipation Derating (Ta ≥ 25°C)	ΔP _T /°C	-2.5	-1.5	mW/°C	
Isolation Voltage (Note 1)	BV _S	5000 (AC, 1min., R.H. ≤ 60%)		V _{rms}	

(Note 1) Device considered a two terminal : LED side pins shorted together, and DETECTOR side pins shorted together.

RECOMMENDED OPERATING CONDITIONS

CHARACTERISTIC	SYMBOL	MIN.	TYP.	MAX.	UNIT
Supply Voltage	V _{CC}	—	5	24	V
Forward Current	I _F	—	16	20	mA
Collector Current	I _C	—	1	10	mA
Operating Temperature	T _{opr}	-25	—	85	°C

INDIVIDUAL ELECTRICAL CHARACTERISTICS (Ta = 25°C)

CHARACTERISTIC		SYMBOL	TEST CONDITION	MIN.	TYP.	MAX.	UNIT
LED	Forward Voltage	V_F	$I_F = 10\text{mA}$	1.0	1.15	1.3	V
	Reverse Current	I_R	$V_R = 5\text{V}$	—	—	10	μA
	Capacitance	C_T	$V = 0, f = 1\text{MHz}$	—	30	—	pF
DETECTOR	Collector-Emitter Breakdown Voltage	$V_{(BR)CEO}$	$I_C = 0.5\text{mA}$	55	—	—	V
	Emitter-Collector Breakdown Voltage	$V_{(BR)ECO}$	$I_E = 0.1\text{mA}$	7	—	—	V
	Collector Dark Current	I_{CEO}	$V_{CE} = 24\text{V}$	—	10	100	nA
			$V_{CE} = 24\text{V}, T_a = 85^\circ\text{C}$	—	2	50	μA
Capacitance (Collector to Emitter)	C_{CE}	$V = 0, f = 1\text{MHz}$	—	10	—	pF	

COUPLED ELECTRICAL CHARACTERISTICS (Ta = 25°C)

CHARACTERISTIC	SYMBOL	TEST CONDITION	MIN.	TYP.	MAX.	UNIT
Current Transfer Ratio	I_C / I_F	$I_F = 5\text{mA}, V_{CE} = 5\text{V}$ Rank GB	50	—	600	%
			100	—	600	
Saturated CTR	$I_C / I_F (\text{sat})$	$I_F = 1\text{mA}, V_{CE} = 0.4\text{V}$ Rank GB	—	60	—	%
			30	—	—	
Collector-Emitter Saturation Voltage	$V_{CE} (\text{sat})$	$I_C = 2.4\text{mA}, I_F = 8\text{mA}$ $I_C = 0.2\text{mA}, I_F = 1\text{mA}$ Rank GB	—	—	0.4	V
			—	0.2	—	
			—	—	0.4	

ISOLATION CHARACTERISTICS (Ta = 25°C)

CHARACTERISTIC	SYMBOL	TEST CONDITION	MIN.	TYP.	MAX.	UNIT
Capacitance (Input to Output)	C_S	$V_S = 0, f = 1\text{MHz}$	—	0.8	—	pF
Isolation Resistance	R_S	$V_S = 500\text{V}$	1×10^{12}	10^{14}	—	Ω
Isolation Voltage	BV_S	AC, 1 minute	5000	—	—	V_{rms}
		AC, 1 second, in oil	—	10000	—	
		DC, 1 minute, in oil	—	10000	—	V_{dc}

勝特力材料 886-3-5753170
 勝特力电子(上海) 86-21-54151736
 勝特力电子(深圳) 86-755-83298787
[Http://www.100y.com.tw](http://www.100y.com.tw)

SWITCHING CHARACTERISTICS (Ta = 25°C)

CHARACTERISTIC	SYMBOL	TEST CONDITION	MIN.	TYP.	MAX.	UNIT
Rise Time	t_r	$V_{CC} = 10V, I_C = 2mA$ $R_L = 100\Omega$	—	2	—	μs
Fall Time	t_f		—	3	—	
Turn-on Time	t_{on}		—	3	—	
Turn-off Time	t_{off}		—	3	—	
Turn-on Time	t_{ON}	$R_L = 1.9k\Omega$ (Fig.1) $V_{CC} = 5V, I_F = 16mA$	—	2	—	μs
Storage Time	t_S		—	15	—	
Turn-off Time	t_{OFF}		—	25	—	

Fig.1 SWITCHING TIME TEST CIRCUIT

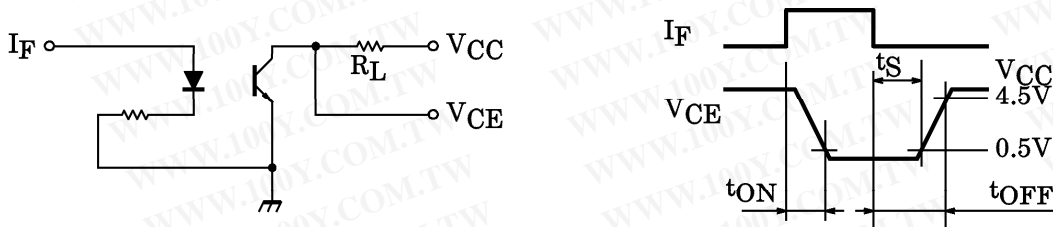

勝特力材料 886-3-5753170
 勝特力电子(上海) 86-21-54151736
 勝特力电子(深圳) 86-755-83298787
[Http://www.100y.com.tw](http://www.100y.com.tw)

勝特力材料 886-3-5753170
 勝特力电子(上海) 86-21-54151736
 勝特力电子(深圳) 86-755-83298787
[Http://www.100y.com.tw](http://www.100y.com.tw)

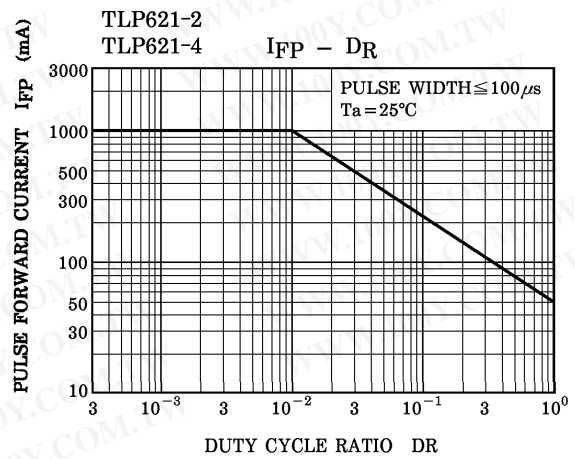
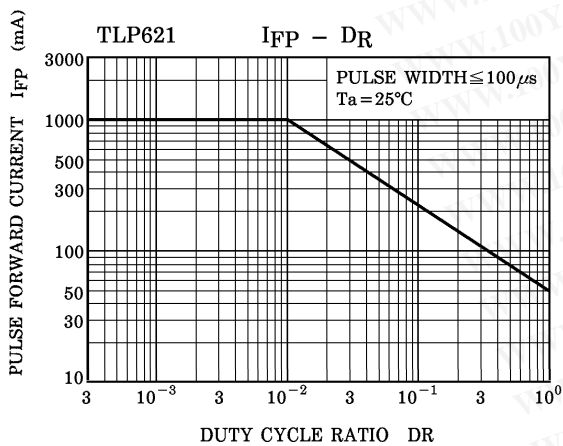
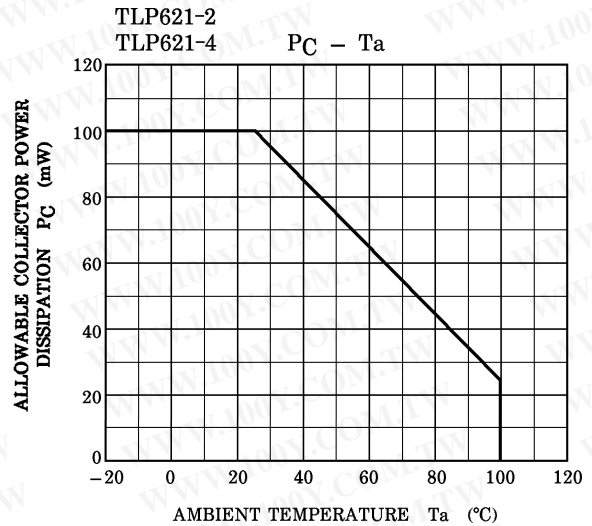
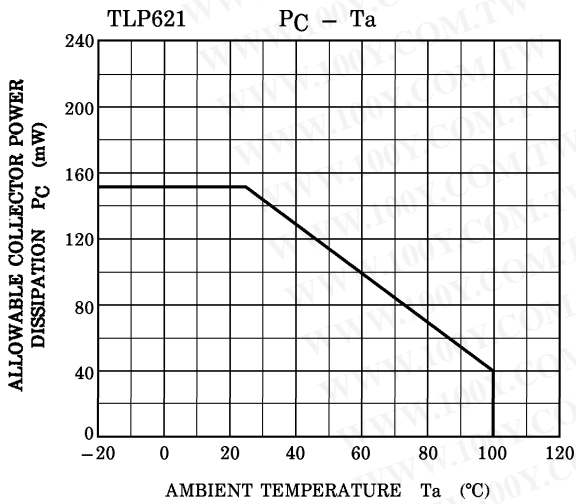
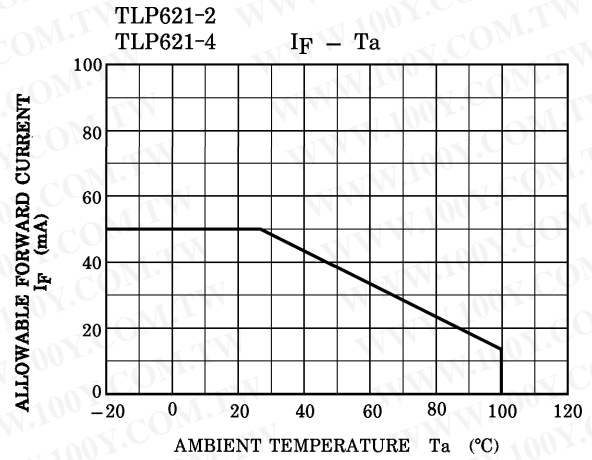
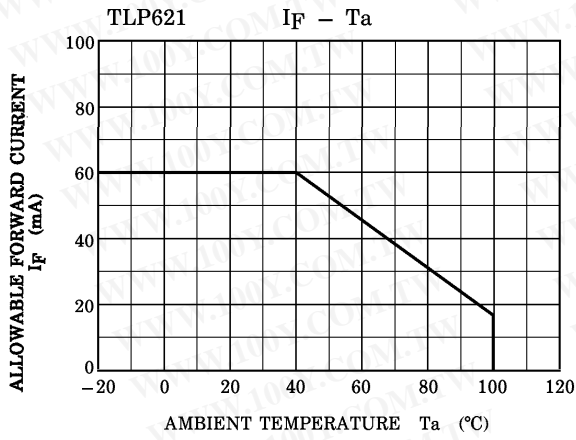

勝特力材料 886-3-5753170
 勝特力电子(上海) 86-21-54151736
 勝特力电子(深圳) 86-755-83298787
[Http://www.100y.com.tw](http://www.100y.com.tw)

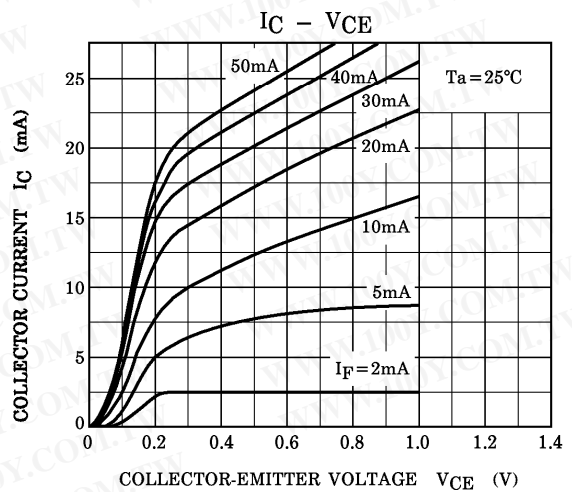
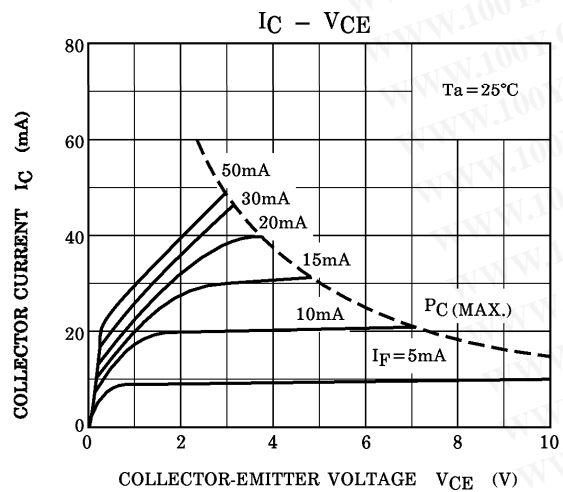
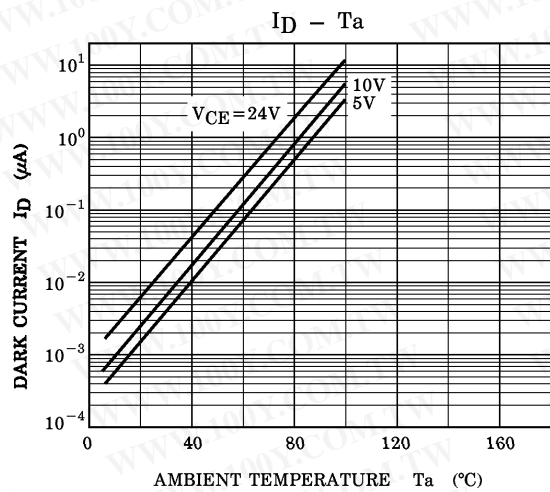
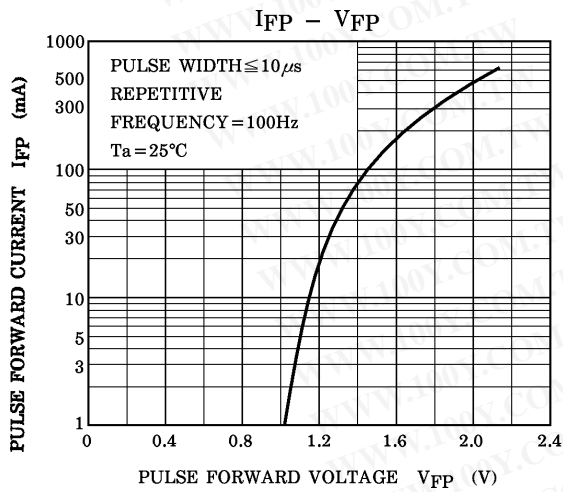
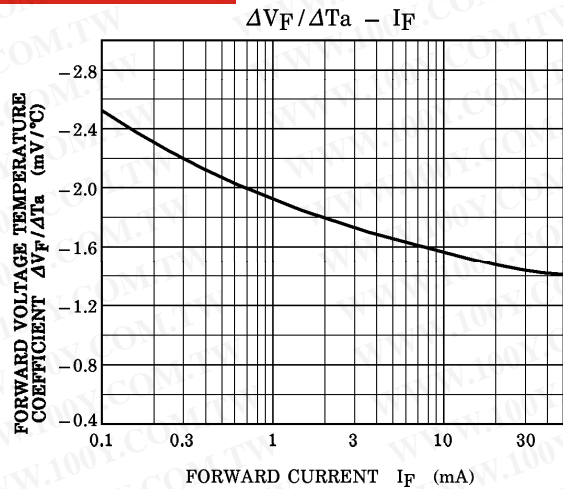
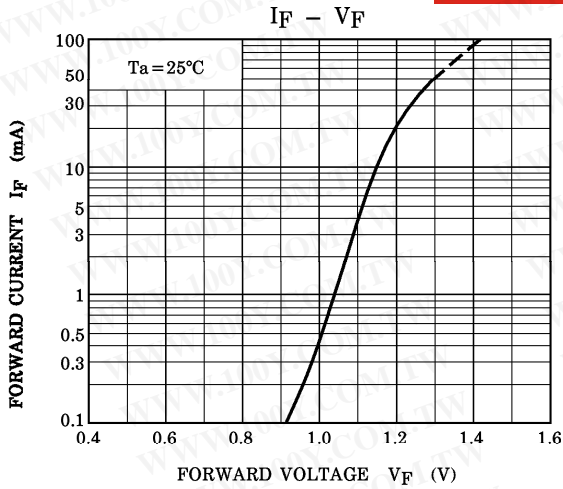

勝特力材料 886-3-5753170
 勝特力电子(上海) 86-21-54151736
 勝特力电子(深圳) 86-755-83298787
[Http://www.100y.com.tw](http://www.100y.com.tw)

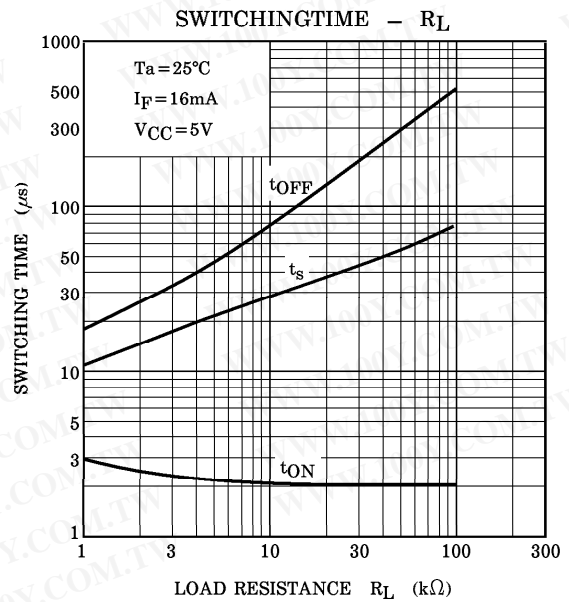
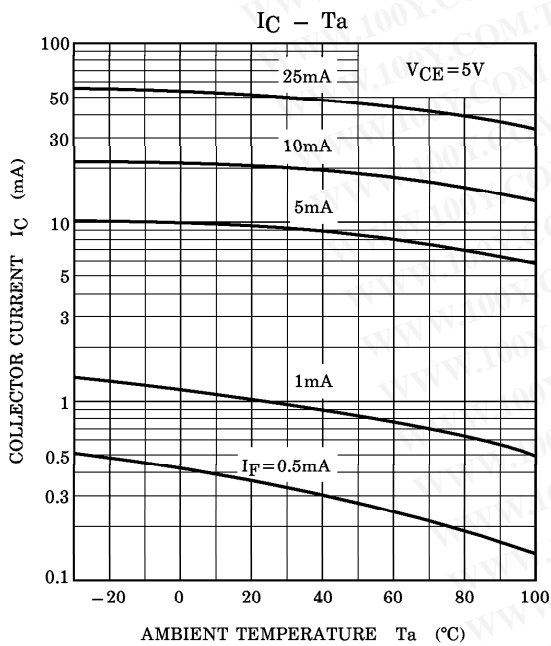
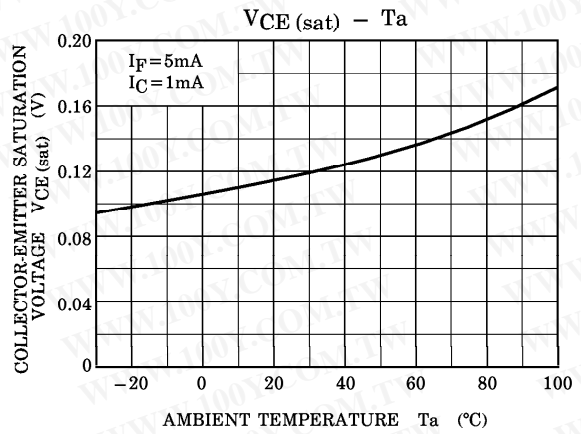
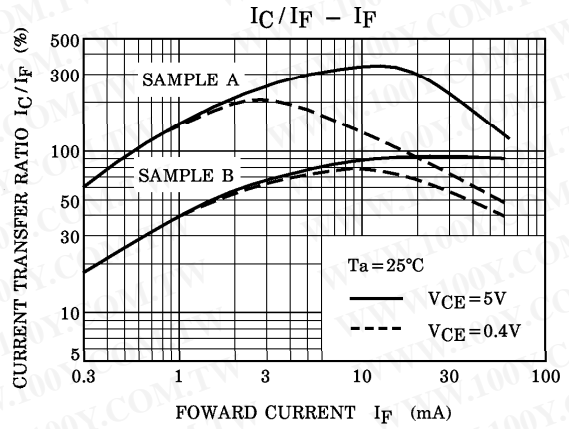
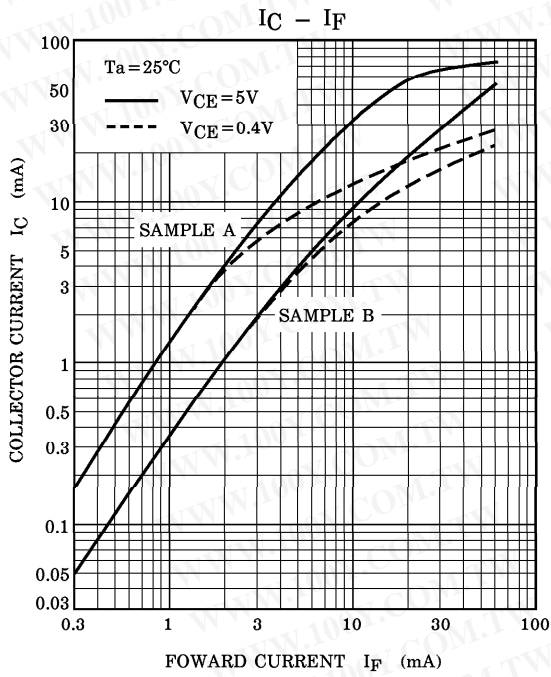

勝特力材料 886-3-5753170
勝特力电子(上海) 86-21-54151736
勝特力电子(深圳) 86-755-83298787
[Http://www.100y.com.tw](http://www.100y.com.tw)

RESTRICTIONS ON PRODUCT USE

000707EBC

- TOSHIBA is continually working to improve the quality and reliability of its products. Nevertheless, semiconductor devices in general can malfunction or fail due to their inherent electrical sensitivity and vulnerability to physical stress. It is the responsibility of the buyer, when utilizing TOSHIBA products, to comply with the standards of safety in making a safe design for the entire system, and to avoid situations in which a malfunction or failure of such TOSHIBA products could cause loss of human life, bodily injury or damage to property. In developing your designs, please ensure that TOSHIBA products are used within specified operating ranges as set forth in the most recent TOSHIBA products specifications. Also, please keep in mind the precautions and conditions set forth in the "Handling Guide for Semiconductor Devices," or "TOSHIBA Semiconductor Reliability Handbook" etc..
- The TOSHIBA products listed in this document are intended for usage in general electronics applications (computer, personal equipment, office equipment, measuring equipment, industrial robotics, domestic appliances, etc.). These TOSHIBA products are neither intended nor warranted for usage in equipment that requires extraordinarily high quality and/or reliability or a malfunction or failure of which may cause loss of human life or bodily injury ("Unintended Usage"). Unintended Usage include atomic energy control instruments, airplane or spaceship instruments, transportation instruments, traffic signal instruments, combustion control instruments, medical instruments, all types of safety devices, etc.. Unintended Usage of TOSHIBA products listed in this document shall be made at the customer's own risk.
- Gallium arsenide (GaAs) is a substance used in the products described in this document. GaAs dust and fumes are toxic. Do not break, cut or pulverize the product, or use chemicals to dissolve them. When disposing of the products, follow the appropriate regulations. Do not dispose of the products with other industrial waste or with domestic garbage.
- The products described in this document are subject to the foreign exchange and foreign trade laws.
- The information contained herein is presented only as a guide for the applications of our products. No responsibility is assumed by TOSHIBA CORPORATION for any infringements of intellectual property or other rights of the third parties which may result from its use. No license is granted by implication or otherwise under any intellectual property or other rights of TOSHIBA CORPORATION or others.
- The information contained herein is subject to change without notice.