

## PROGRAMMABLE VOLTAGE REFERENCE

- ADJUSTABLE OUTPUT VOLTAGE :  
 $V_{ref}$  to 36V
- SINK CURRENT CAPABILITY : 1 to 100mA
- TYPICAL OUTPUT IMPEDANCE : 0.2Ω
- 0.4% AND 0.25% VOLTAGE PRECISION

勝特力材料 886-3-5753170  
 勝特力电子(上海) 86-21-54151736  
 勝特力电子(深圳) 86-755-83298787  
[Http://www.100y.com.tw](http://www.100y.com.tw)

### DESCRIPTION

The TL1431 is a programmable shunt voltage reference with guaranteed temperature stability over the entire temperature range of operation.

The output voltage may be set to any value between  $V_{ref}$  (approximately 2.5V) and 36V with two external resistors.

The TL1431 operates with a wide current range from 1 to 100mA with a typical dynamic impedance of 0.2Ω.

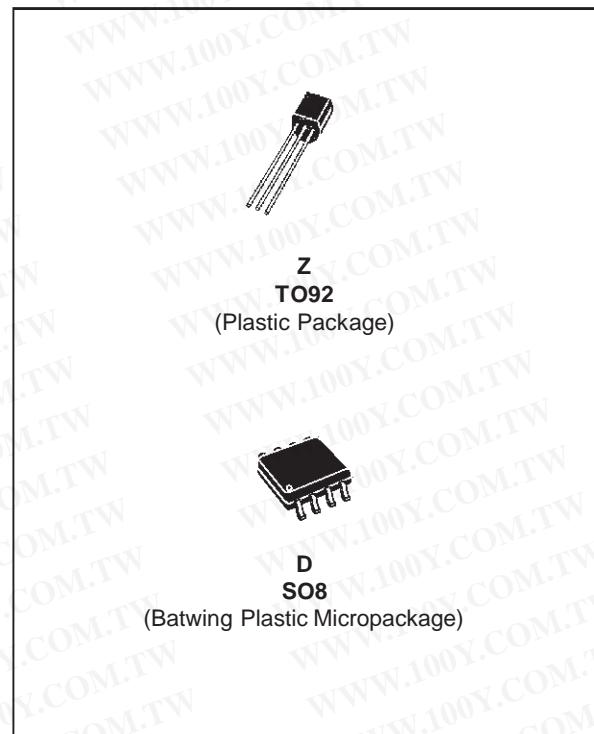

### ORDER CODES

Part number	Temperature Range	Package	
		Z	D
TL1431C/AC	-20°C, +70°C	•	•
TL1431I/AI	-40°C, +105°C	•	•

### PIN CONNECTIONS

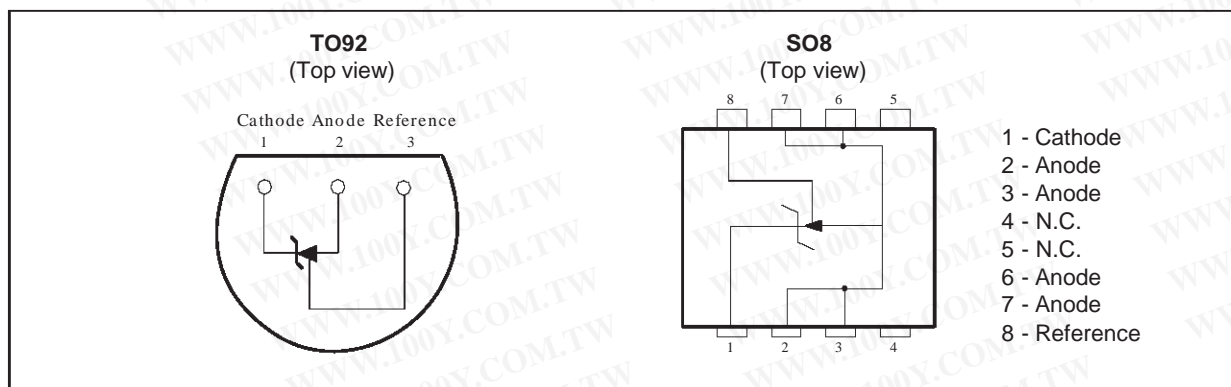

**ABSOLUTE MAXIMUM RATINGS**

Symbol	Parameter	Value	Unit
V <sub>KA</sub>	Cathode to Anode Voltage	37	V
I <sub>K</sub>	Continuous Cathode Current Range	-100 to +150	mA
I <sub>ref</sub>	Reference Input Current Range	-0.05 to +10	mA
T <sub>oper</sub>	Operating Free-air Temperature Range TL1431C/AC TL1431I/AI	-20 to +70 -40 to +105	°C
T <sub>stg</sub>	Storage Temperature Range	-65 to +150	°C

**OPERATING CONDITIONS**

Symbol	Parameter	Value	Unit
V <sub>KA</sub>	Cathode to Anode Voltage	V <sub>ref</sub> to 36	V
I <sub>K</sub>	Cathode Current	1 to 100	mA

**ELECTRICAL CHARACTERISTICS**

T<sub>amb</sub> = 25°C (unless otherwise specified)

Symbol	Parameter	TL1431C			TL1431AC			Unit
		Min.	Typ.	Max.	Min.	Typ.	Max.	
V <sub>ref</sub>	Reference Input Voltage - (figure 1) V <sub>KA</sub> = V <sub>ref</sub> , I <sub>K</sub> = 10mA T <sub>amb</sub> = 25°C	2.490	2.500	2.510	2.493	2.500	2.507	V
ΔV <sub>ref</sub>	Reference Input Voltage Deviation Over Temperature Range - (figure 1, note 1) V <sub>KA</sub> = V <sub>ref</sub> , I <sub>K</sub> = 10mA, T <sub>min.</sub> ≤ T <sub>amb</sub> ≤ T <sub>max.</sub>		3	20		3	20	mV
$\frac{\Delta V_{ref}}{\Delta T}$	Temperature Coefficient of Reference Input Voltage - (note 2) V <sub>KA</sub> = V <sub>ref</sub> , I <sub>K</sub> = 10mA, T <sub>min.</sub> ≤ T <sub>amb</sub> ≤ T <sub>max.</sub>		±13	±90		±13	±90	ppm/°C
$\frac{\Delta V_{ref}}{\Delta V_{KA}}$	Ratio of Change in Reference Input Voltage to Change in Cathode to Anode Voltage - (figure 2) I <sub>K</sub> = 10mA, ΔV <sub>KA</sub> = 36V to 3V	-2	-1.1		-2	-1.1		mV/V
I <sub>ref</sub>	Reference Input Current - (figure 2) I <sub>K</sub> = 10mA, R <sub>1</sub> = 10kΩ, R <sub>2</sub> = ∞ T <sub>amb</sub> = 25°C T <sub>min.</sub> ≤ T <sub>amb</sub> ≤ T <sub>max.</sub>		1.5	2.5 3		1.5	2.5 3	μA
ΔI <sub>ref</sub>	Reference Input Current Deviation Over Temperature Range - (figure 2) I <sub>K</sub> = 10mA, R <sub>1</sub> = 10kΩ, R <sub>2</sub> = ∞ T <sub>min.</sub> ≤ T <sub>amb</sub> ≤ T <sub>max.</sub>		0.2	1.2		0.2	1.2	μA
I <sub>min</sub>	Minimum Cathode Current for Regulation - (figure 1) V <sub>KA</sub> = V <sub>ref</sub>		0.5	1		0.5	0.6	mA
I <sub>off</sub>	Off-State Cathode Current - (figure 3)		180	500		180	500	nA
Z <sub>KA</sub>	Dynamic Impedance - (figure 1, note 3) V <sub>KA</sub> = V <sub>ref</sub> , ΔI <sub>K</sub> = 1 to 100mA, f ≤ 1kHz		0.2	0.5		0.2	0.5	Ω

**Notes :** 1. ΔV<sub>ref</sub> is defined as the difference between the maximum and minimum values obtained over the full temperature range.

ΔV<sub>ref</sub> = V<sub>refmax.</sub> - V<sub>refmin.</sub>

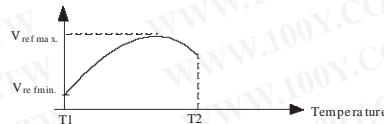

2. The temperature coefficient is defined as the slopes (positive and negative) of the voltage vs temperature limits within which the reference voltage is guaranteed.

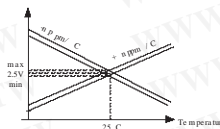

3. The dynamic Impedance is defined as  $|Z_{KA}| = \frac{\Delta V_{KA}}{\Delta I_K}$

**ELECTRICAL CHARACTERISTICS**

T<sub>amb</sub> = 25°C (unless otherwise specified)

Symbol	Parameter	TL1431I			TL1431AI			Unit
		Min.	Typ.	Max.	Min.	Typ.	Max.	
V <sub>ref</sub>	Reference Input Voltage - (figure 1) V <sub>KA</sub> = V <sub>ref</sub> , I <sub>K</sub> = 10mA T <sub>amb</sub> = 25°C	2.490	2.500	2.510	2.493	2.500	2.507	V
ΔV <sub>ref</sub>	Reference Input Voltage Deviation Over Temperature Range - (figure 1, note 1) V <sub>KA</sub> = V <sub>ref</sub> , I <sub>K</sub> = 10mA, T <sub>min.</sub> ≤ T <sub>amb</sub> ≤ T <sub>max.</sub>		7	30		7	30	mV
$\frac{\Delta V_{ref}}{\Delta T}$	Temperature Coefficient of Reference Input Voltage - (note 2) V <sub>KA</sub> = V <sub>ref</sub> , I <sub>K</sub> = 10mA, T <sub>min.</sub> ≤ T <sub>amb</sub> ≤ T <sub>max.</sub>		±22	±100		±22	±100	ppm/°C
$\frac{\Delta V_{ref}}{\Delta V_{KA}}$	Ratio of Change in Reference Input Voltage to Change in Cathode to Anode Voltage - (figure 2) I <sub>K</sub> = 10mA, ΔV <sub>KA</sub> = 36 to 3V		-1.1	-2		-1.1	-2	mV/V
I <sub>ref</sub>	Reference Input Current - (figure 2) I <sub>K</sub> = 10mA, R <sub>1</sub> = 10kΩ, R <sub>2</sub> = ∞ T <sub>amb</sub> = 25°C T <sub>min.</sub> ≤ T <sub>amb</sub> ≤ T <sub>max.</sub>		1.5	2.5 3		1.5	2.5 3	μA
ΔI <sub>ref</sub>	Reference Input Current Deviation Over Temperature Range - (figure 2) I <sub>K</sub> = 10mA, R <sub>1</sub> = 10kΩ, R <sub>2</sub> = ∞ T <sub>min.</sub> ≤ T <sub>amb</sub> ≤ T <sub>max.</sub>		0.5	1		0.8	1.2	μA
I <sub>min</sub>	Minimum Cathode Current for Regulation (figure 1) V <sub>KA</sub> = V <sub>ref</sub>		0.5	1		0.5	0.7	mA
I <sub>off</sub>	Off-State Cathode Current - (figure 3)		180	500		180	500	nA
Z <sub>KA</sub>	Dynamic Impedance - (figure 1, note 3) V <sub>KA</sub> = V <sub>ref</sub> , ΔI <sub>K</sub> = 1 to 100mA, f ≤ 1kHz		0.2	0.5		0.2	0.5	Ω

Notes : 1. ΔV<sub>ref</sub> is defined as the difference between the maximum and minimum values obtained over the full temperature range.

$$\Delta V_{ref} = V_{ref\ max.} - V_{ref\ min.}$$

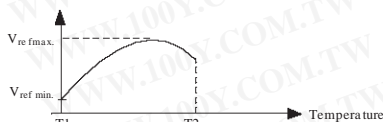

2. The temperature coefficient is defined as the slopes (positive and negative) of the voltage vs temperature limits within which the reference voltage is guaranteed.

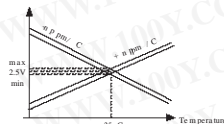

3. The dynamic Impedance is defined as  $|Z_{KA}| = \frac{\Delta V_{KA}}{\Delta I_K}$

**勝特力材料 886-3-5753170**  
**勝特力电子(上海) 86-21-54151736**  
**勝特力电子(深圳) 86-755-83298787**  
[Http://www.100y.com.tw](http://www.100y.com.tw)

Figure 1 : Test Circuit for  $V_{KA} = V_{ref}$

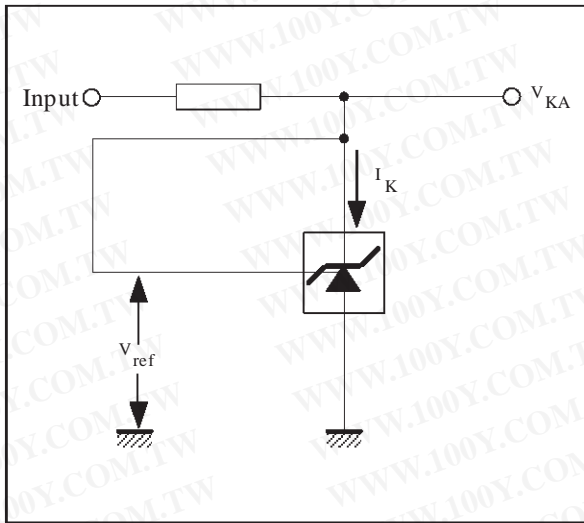

Figure 2 : Test Circuit for  $V_{KA} > V_{ref}$

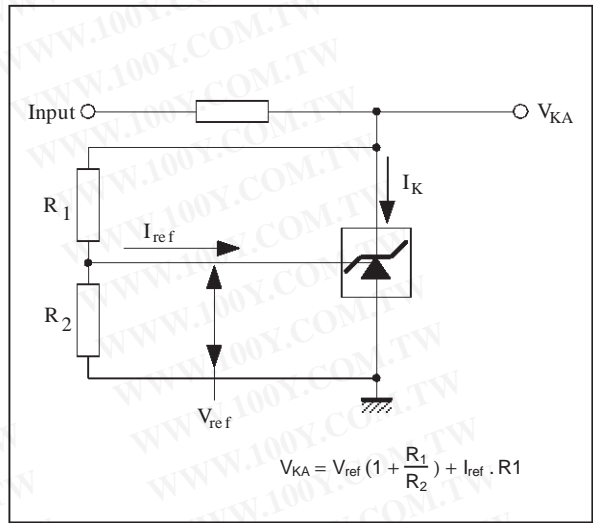

Figure 3 : Test Circuit for  $I_{off}$

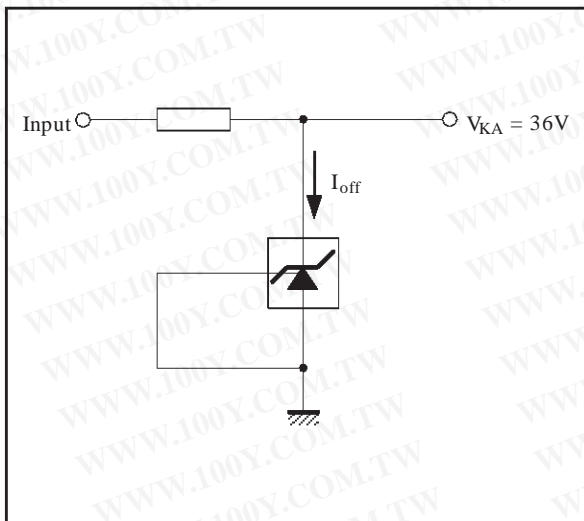
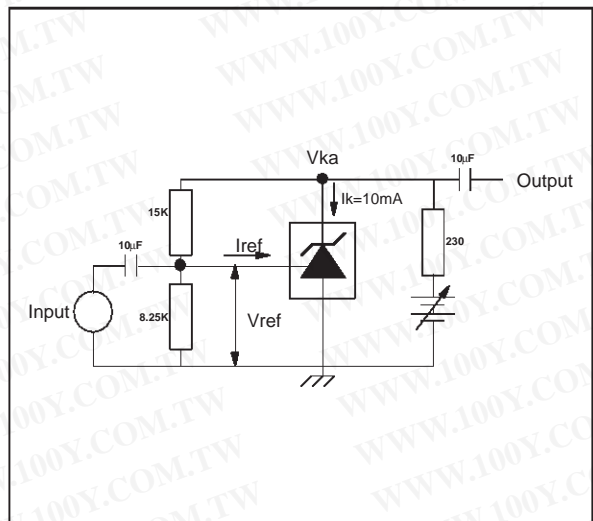
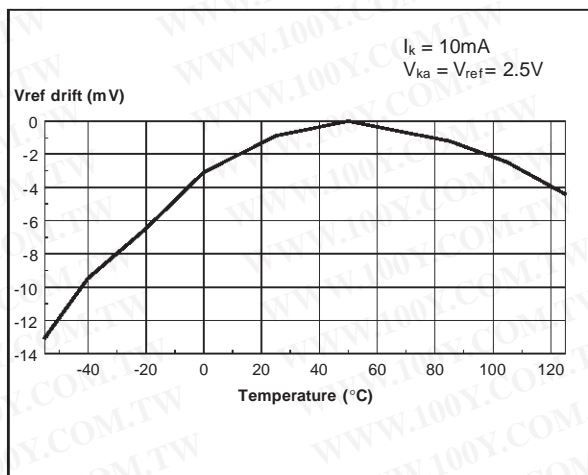

Figure 4 : Test Circuit for Phase Margin and Voltage Gain



勝特力材料 886-3-5753170  
 勝特力电子(上海) 86-21-54151736  
 勝特力电子(深圳) 86-755-83298787  
[Http://www.100y.com.tw](http://www.100y.com.tw)

DRIFT (mV) vs TEMPERATURE (°C)



CATHODE CURRENT vs CATHODE VOLTAGE

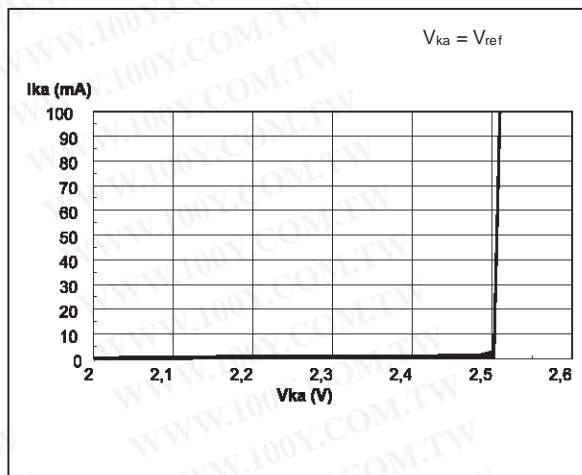

CATHODE CURRENT vs CATHODE VOLTAGE (detailed version)

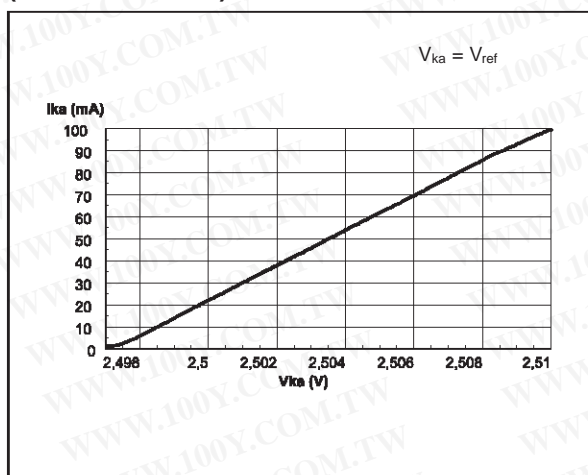

REFERENCE CURRENT vs TEMPERATURE

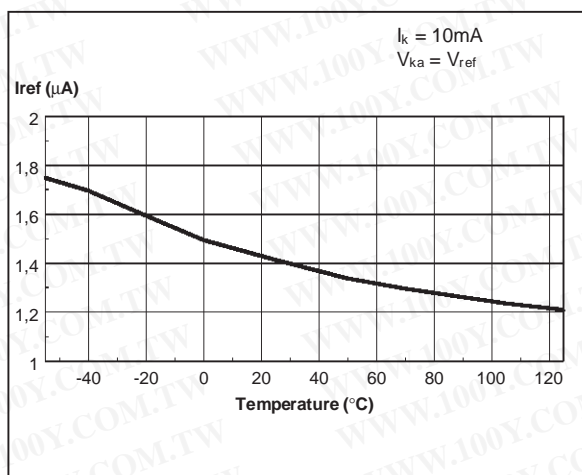

OFF-STATE CATHODE CURRENT vs TEMPERATURE

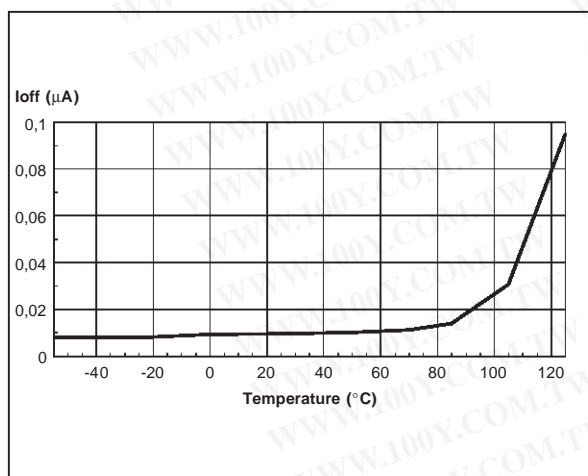

RATIO OF CHANGE IN Vref TO CHANGE IN Vka vs TEMPERATURE

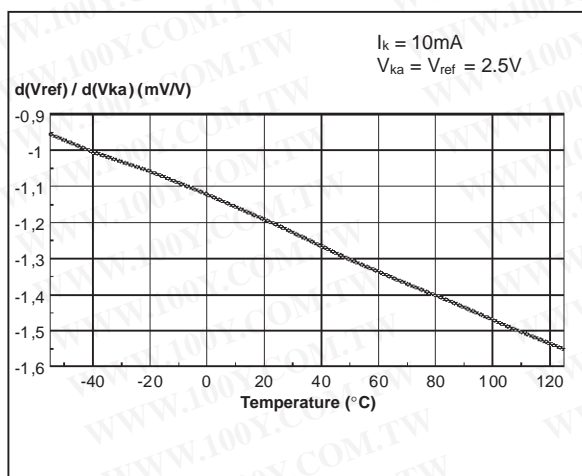

勝特力材料 886-3-5753170  
 勝特力电子(上海) 86-21-54151736  
 勝特力电子(深圳) 86-755-83298787  
[Http://www.100y.com.tw](http://www.100y.com.tw)

**DRIFT OF R<sub>KA</sub> vs TEMPERATURE**

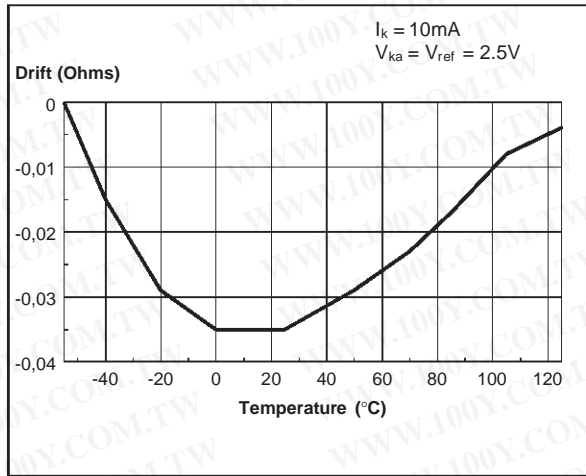

**MINIMUM OPERATING CURRENT vs TEMPERATURE**

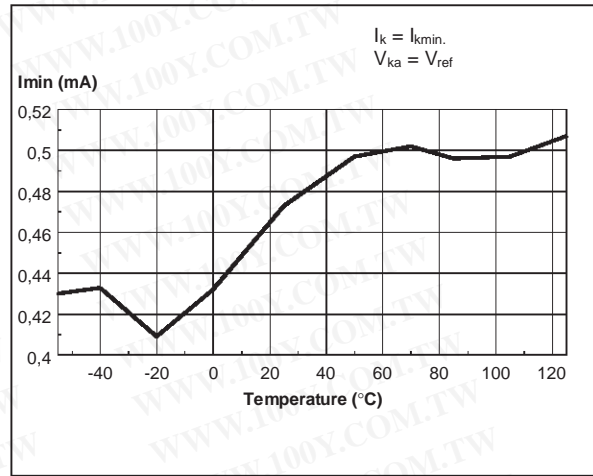

**PHASE MARGIN vs FREQUENCY**

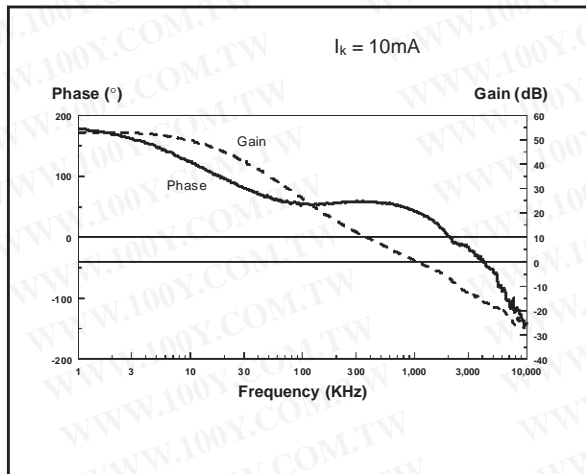

**STABILITY FOR CAPACITIVE LOADS**

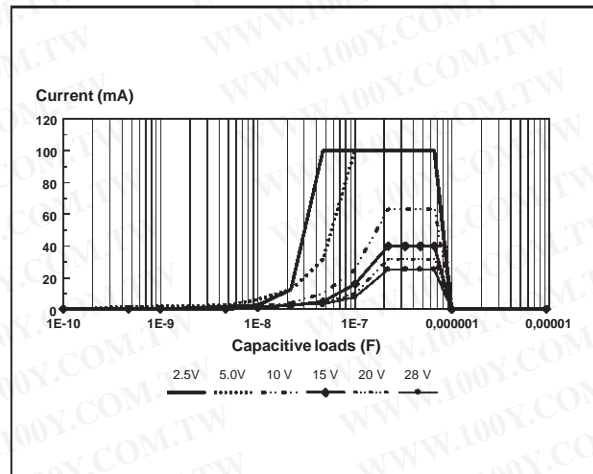

**勝特力材料 86-3-5753170**  
**勝特力电子(上海) 86-21-54151736**  
**勝特力电子(深圳) 86-755-83298787**  
[Http://www.100y.com.tw](http://www.100y.com.tw)

## PACKAGE MECHANICAL DATA

## 8 PINS - BATWING PLASTIC MICROPACKAGE (SO)

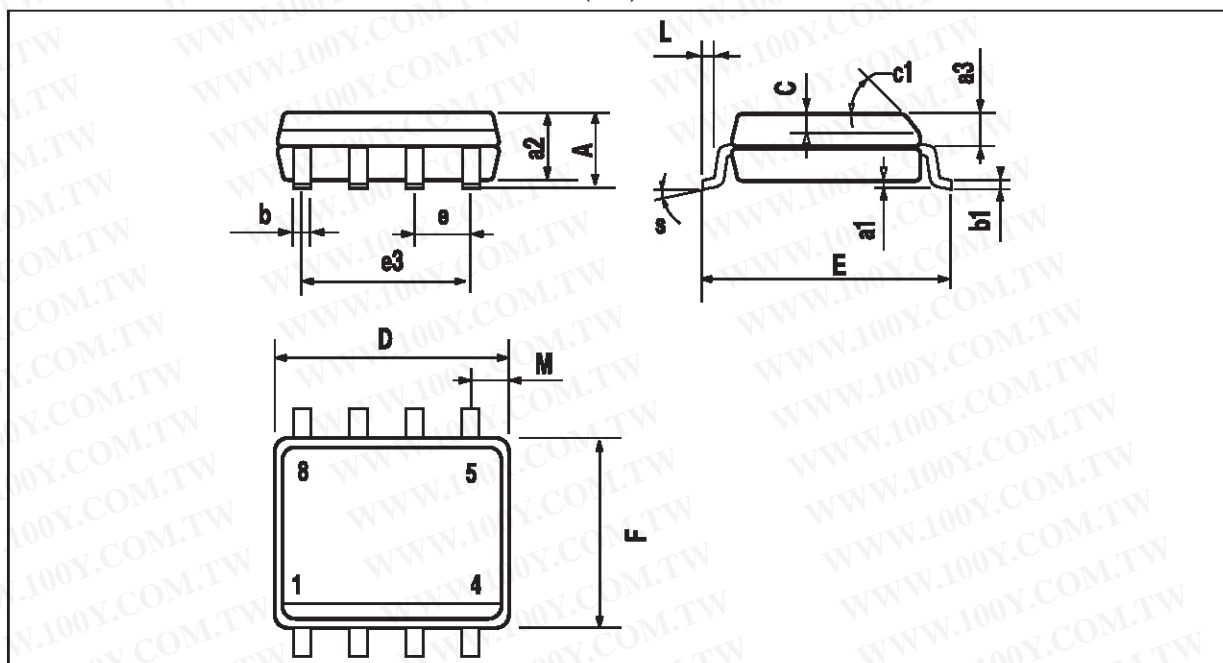

Dimensions	Millimeters			Inches		
	Min.	Typ.	Max.	Min.	Typ.	Max.
A			1.75			0.069
a1	0.1		0.25	0.004		0.010
a2			1.65			0.065
a3	0.65		0.85	0.026		0.033
b	0.35		0.48	0.014		0.019
b1	0.19		0.25	0.007		0.010
C	0.25		0.5	0.010		0.020
c1	45° (typ.)					
D	4.8		5.0	0.189		0.197
E	5.8		6.2	0.228		0.244
e		1.27			0.050	
e3		3.81			0.150	
F	3.8		4.0	0.150		0.157
L	0.4		1.27	0.016		0.050
M			0.6			0.024
S	8° (max.)					

勝特力材料 886-3-5753170  
 勝特力电子(上海) 86-21-54151736  
 勝特力电子(深圳) 86-755-83298787  
[Http://www.100y.com.tw](http://www.100y.com.tw)

**PACKAGE MECHANICAL DATA**  
**3 PINS - PLASTIC PACKAGE TO92**



Dimensions	Millimeters			Inches		
	Min.	Typ.	Max.	Min.	Typ.	Max.
L		1.27			0.05	
B	3.2	3.7	4.2	0.126	0.1457	0.1654
O1	4.45	5.00	5.2	0.1752	0.1969	0.2047
C	4.58	5.03	5.33	0.1803	0.198	0.2098
K	12.7			0.5		
O2	0.407	0.5	0.508	0.016	0.0197	0.02
a	0.35			0.0138		

**勝特力材料 886-3-5753170**  
**勝特力电子(上海) 86-21-54151736**  
**勝特力电子(深圳) 86-755-83298787**  
[Http://www.100y.com.tw](http://www.100y.com.tw)

Information furnished is believed to be accurate and reliable. However, SGS-THOMSON Microelectronics assumes no responsibility for the consequences of use of such information nor for any infringement of patents or other rights of third parties which may result from its use. No license is granted by implication or otherwise under any patent or patent rights of SGS-THOMSON Microelectronics. Specification mentioned in this publication are subject to change without notice. This publication supersedes and replaces all information previously supplied. SGS-THOMSON Microelectronics products are not authorized for use as critical components in life support devices or systems without express written approval of SGS-THOMSON Microelectronics.

© 1998 SGS-THOMSON Microelectronics – Printed in Italy – All Rights Reserved

**SGS-THOMSON Microelectronics GROUP OF COMPANIES**  
 Australia - Brazil - Canada - China - France - Germany - Italy - Japan - Korea - Malaysia - Malta - Morocco  
 The Netherlands - Singapore - Spain - Sweden - Switzerland - Taiwan - Thailand - United Kingdom - U.S.A.

