



# TC7662A

## CHARGE PUMP DC-TO-DC CONVERTER

### FEATURES

- Wide Operating Range ..... 3V to 18V
- Increased Output Current ..... 40mA
- Pin Compatible with ICL7662/SI7661/TC7660/LTC1044
- No External Diodes Required
- Low Output Impedance @  $I_L = 20\text{mA}$  .....  $40\Omega$  Typ.
- No Low-Voltage Terminal Required
- CMOS Construction

### ORDERING INFORMATION

Part No.	Package	Temperature Range
TC7662ACPA	8-Pin Plastic DIP	0°C to +70°C
TC7662AEPA	8-Pin Plastic DIP	-40°C to +85°C
TC7662AIJA	8-Pin CerDIP	-25°C to +85°C
TC7662AMJA	8-Pin CerDIP	-55°C to +125°C
<b>TC7660EV</b>	<b>Evaluation Kit for Charge Pump Family</b>	

### GENERAL DESCRIPTION

The TC7662A is a pin-compatible upgrade to the industry standard TC7660 charge pump voltage converter. It converts a +3V to +18V input to a corresponding -3V to -18V output using only two low-cost capacitors, eliminating inductors and their associated cost, size and EMI. In addition to a wider power supply input range (3V to 18V versus 1.5V to 10V for the TC7660), the TC7662A can source output currents as high as 40mA. The on-board oscillator operates at a nominal frequency of 12kHz. Operation below 10kHz (for lower supply current applications) is also possible by connecting an external capacitor from OSC to ground.

The TC7662A directly is recommended for designs requiring greater output current and/or lower input/output voltage drop. It is available in 8-pin DIP packages in commercial and extended temperature ranges.



### PIN CONFIGURATION

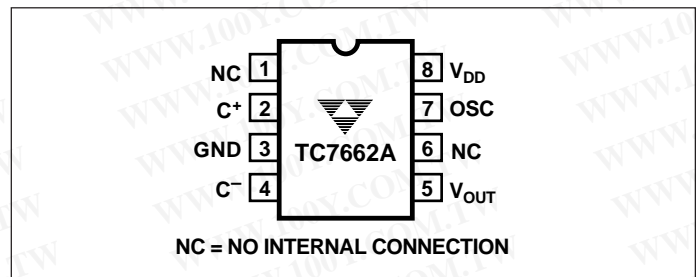

### FUNCTIONAL BLOCK DIAGRAM

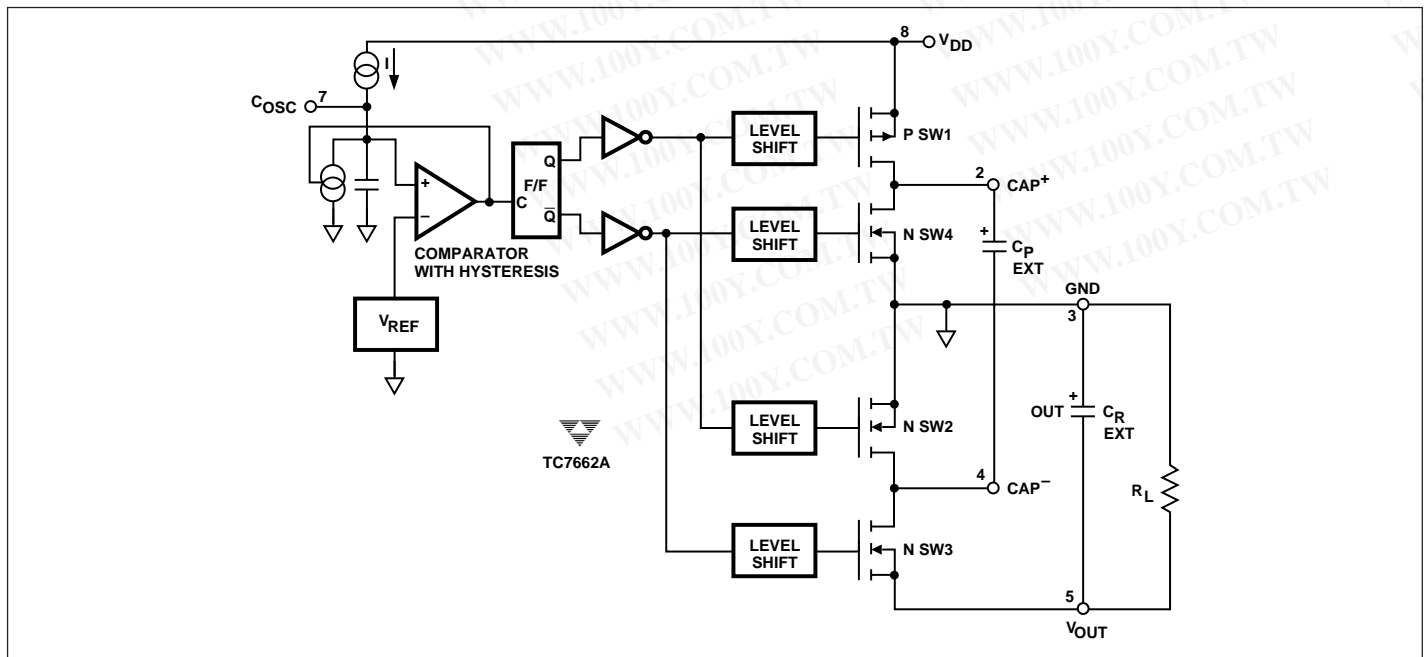

**TC7662A**

**ABSOLUTE MAXIMUM RATINGS\***

Supply Voltage $V_{DD}$ to GND .....	+18V
Input Voltage (Any Pin) .....	$(V_{DD} + 0.3)$ to $(V_{SS} - 0.3)$
Current Into Any Pin .....	10mA
Operating Temperature Range	
C Suffix .....	0°C to +70°C
I Suffix .....	- 25°C to +85°C
E Suffix .....	- 40°C to +85°C
M Suffix .....	- 55°C to +125°C
Power Dissipation ( $T_A \leq 70^\circ\text{C}$ )	
Plastic DIP .....	730mW
CerDIP .....	800mW

Package Thermal Resistance

CPA, EPA $\theta_{JA}$ .....	140°C/W
IJA, MJA $\theta_{JA}$ .....	90°C/W
Storage Temperature Range .....	- 65°C to +150°C
Lead Temperature (Soldering, 10 sec) .....	+300°C
ESD Protection .....	$\pm 2000\text{V}$
Output Short Circuit .....	Continuous (at 5.5V Input)

\*Static-sensitive device. Unused devices must be stored in conductive material. Protect devices from static discharge and static fields. Stresses above those listed under Absolute Maximum Ratings may cause permanent damage to the device. These are stress ratings only and functional operation of the device at these or any other conditions above those indicated in the operational sections of the specifications is not implied. Exposure to Absolute Maximum Rating Conditions for extended periods may affect device reliability.

**ELECTRICAL CHARACTERISTICS:**  $V_{DD} = 15\text{V}$ ,  $T_A = +25^\circ\text{C}$  (See Test Circuit), unless otherwise specified.

Symbol	Parameter	Test Conditions	Min	Typ	Max	Unit
$V_{DD}$	Supply Voltage		3	—	18	V
$I_S$	Supply Current	$R_L = \infty$	—	510	700	$\mu\text{A}$
	$V_{DD} = +15\text{V}$	$0^\circ\text{C} \leq T_A \leq +70^\circ\text{C}$	—	560	—	
		$-55^\circ\text{C} \leq T_A \leq +125^\circ\text{C}$	—	650	—	
	$V_{DD} = +5\text{V}$	$0^\circ\text{C} \leq T_A \leq +70^\circ\text{C}$	—	190	—	
		$-55^\circ\text{C} \leq T_A \leq +125^\circ\text{C}$	—	210	—	
$R_O$	Output Source Resistance	$I_L = 20\text{mA}$ , $V_{DD} = +15\text{V}$	—	40	50	$\Omega$
		$I_L = 40\text{mA}$ , $V_{DD} = +15\text{V}$	—	50	60	
		$I_L = 3\text{mA}$ , $V_{DD} = +5\text{V}$	—	100	125	
$C_{OSC}$	Oscillator Frequency		—	12	—	kHz
$P_{EFF}$	Power Efficiency	$V_{DD} = +15\text{V}$ $R_L = 2\text{k}\Omega$	93	97	—	%
$V_{EFF}$	Voltage Efficiency	$V_{DD} = +15\text{V}$ $R_L = \infty$	99	99.9	—	%
		Over Operating Temperature Range	96	—	—	

# CHARGE PUMP DC-TO-DC CONVERTER

胜特力材料 886-3-5753170  
 胜特力电子(上海) 86-21-54151736  
 胜特力电子(深圳) 86-755-83298787  
[Http://www.100y.com.tw](http://www.100y.com.tw)

## TC7662A

### TEST CIRCUIT

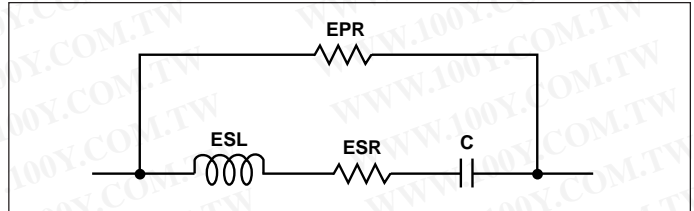
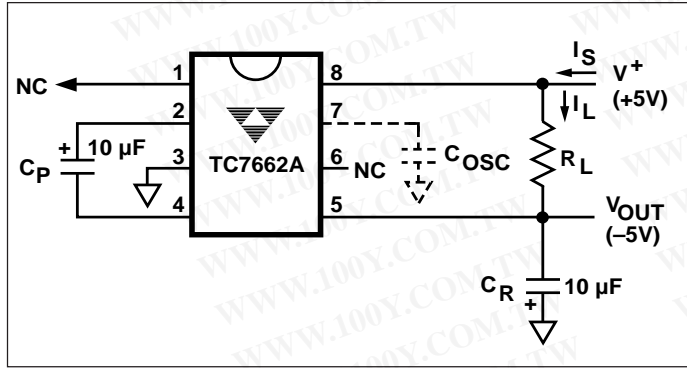

Figure 1. Capacitor Equivalent Circuit

Note one of its characteristics is ESR (equivalent series resistance). This parasitic resistance winds up in series with the load. Thus, both voltage and power conversion efficiency are compromised if a low ESR capacitor is not used.

For example, in the "Test Circuit", changing  $C_P$  and  $C_R$  capacitors from typical ESR to low ESR types, the effective converter output impedance changed from 45Ω to 40Ω, an improvement of 12%.

This applies to all types of capacitors, including film types (polyester, polycarbonate etc.).

Some applications information suggests that the capacitor is not critical and attributes the limiting factor to the capacitor's reactance value. Let's examine this:

$$X_C = \frac{1}{2\pi f C} \quad \text{and} \quad Z_C = \frac{X_C}{DS}$$

where DS (duty cycle) = 50%.

Thus,  $Z_C \approx 1.33\Omega$  at  $f = 12\text{kHz}$ , where  $C = 10\ \mu\text{F}$ .

For the TC7662A,  $f = 12,000\text{Hz}$ , and a typical value of  $C$  would be  $10\ \mu\text{F}$ . This is a reactive impedance of  $\approx 1.33\Omega$ . If the ESR is as great as  $5\Omega$ , the reactive value is not as critical as it would first appear, since the ESR would dominate. The  $5\Omega$  value is typical of a general-purpose electrolytic capacitor.

### Synchronizing

The TC7662A may be synchronized by connecting pin 7 of the TC7662A through a 100k resistor in series with a diode to a negative-going pulse source. The negative pulse voltage can be +5V with a 5 microsecond duration going negative to 0V.

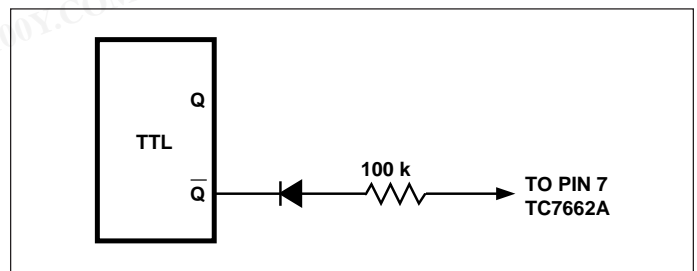

Figure 2. Synchronization

## APPLICATIONS INFORMATION

### Theory of Operation

The TC7662A is a capacitive charge pump (sometimes called a switched-capacitor circuit), where four MOSFET switches control the charge and discharge of a capacitor.

The functional diagram (page 1) shows how the switching action works. SW1 and SW2 are turned on simultaneously, charging  $C_1$  to the supply voltage,  $V_{DD}$ . This assumes that the ON resistance of the MOSFETs in series with the capacitor produce a charging time (3 time constants) less than the ON time provided by the oscillator frequency, as shown:

$$3 (R_{DS(ON)} C_1) < C_1 / (0.5 f_{OSC})$$

In the next cycle, SW1 and SW2 are turned OFF and, after a very short interval with all switches OFF (preventing large currents from occurring due to cross conduction), SW3 and SW4 are turned ON. The charge in  $C_1$  is then transferred to  $C_{OUT}$ , BUT WITH THE POLARITY INVERTED. In this way, a negative voltage is derived.

An oscillator supplies pulses to a flip-flop that is fed to a set of level shifters. These level shifters then drive each set of switches at one-half the oscillator frequency.

The oscillator has a pin that controls the frequency of oscillation. Pin 7 can have a capacitor added that is connected to ground. This will lower the frequency of the oscillator by adding capacitance to the internal timing capacitor of the TC7662A. (See Oscillator Frequency vs.  $C_{EXT}$ , page 5.)

### Capacitors

In early charge pump converters, capacitors were not considered critical due to the high  $R_{DS(ON)}$  of the MOSFET switches. In order to understand this, let's look at a model of a typical electrolytic capacitor (Figure 1).

**TC7662A**

**TYPICAL APPLICATIONS**

**Combined Negative Converter and Positive Multiplier**

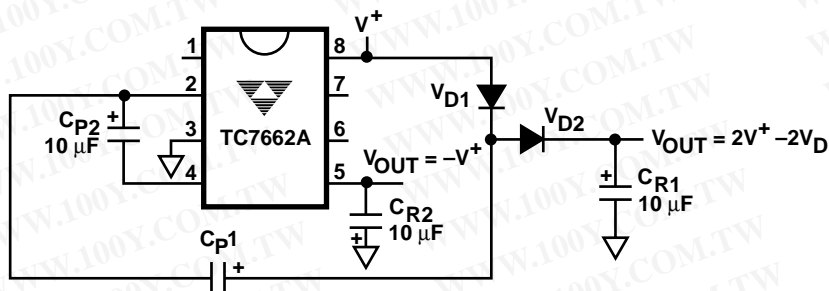

**Lowering Output Resistance by Paralleling Devices**

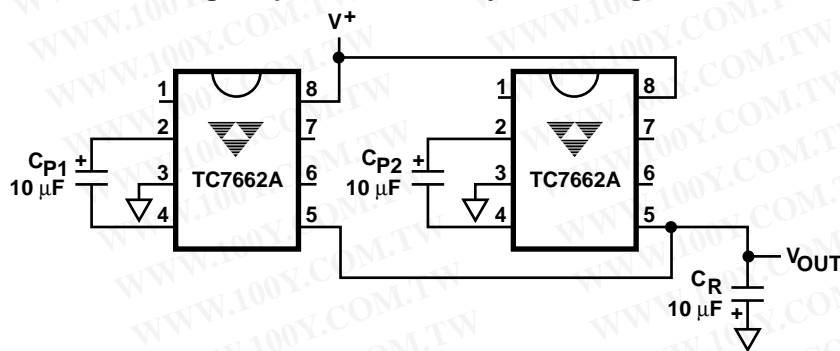

**Positive Voltage Multiplier**

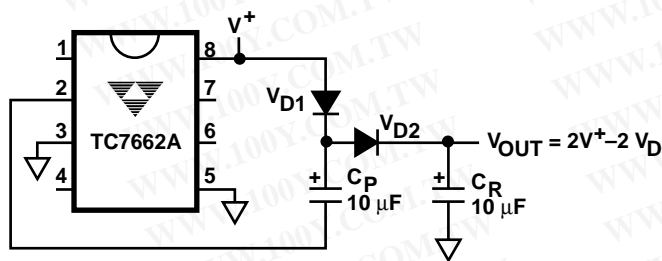

**Split V+ In Half**

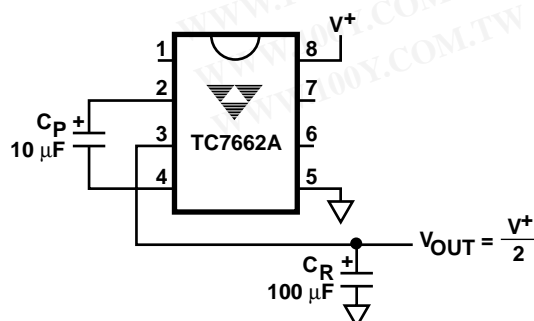

# CHARGE PUMP DC-TO-DC CONVERTER

胜特力材料 886-3-5753170  
 胜特力电子(上海) 86-21-54151736  
 胜特力电子(深圳) 86-755-83298787  
[Http://www.100y.com.tw](http://www.100y.com.tw)

TC7662A

## TYPICAL CHARACTERISTICS

Supply Current vs. Temperature

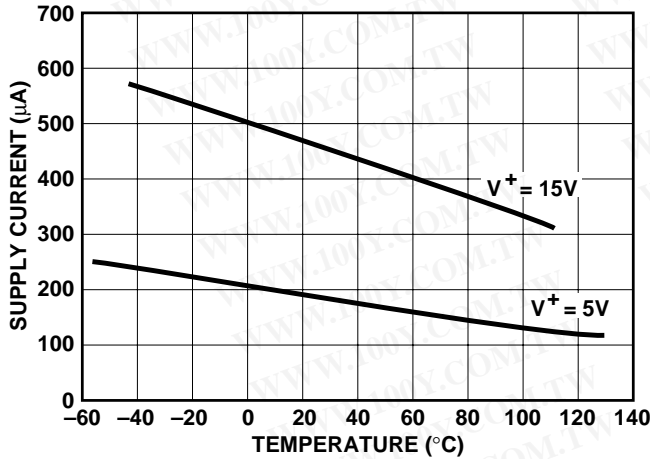

Oscillator Frequency vs. C<sub>EXT</sub>

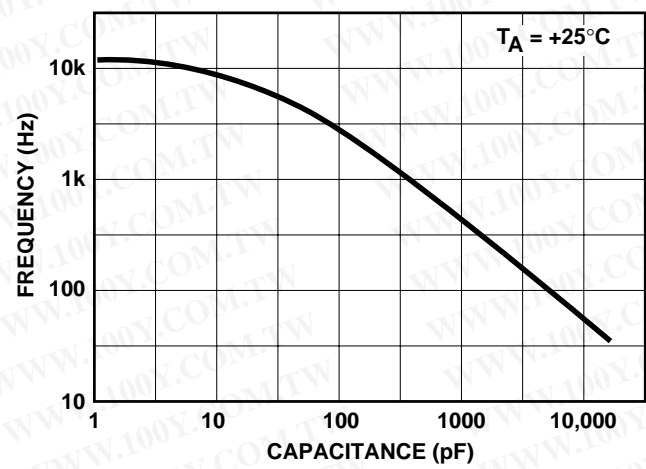

Frequency vs. Temperature

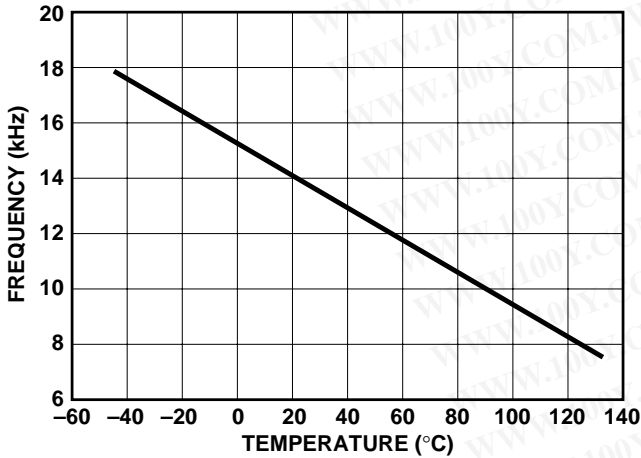

Output Resistance vs. Temperature

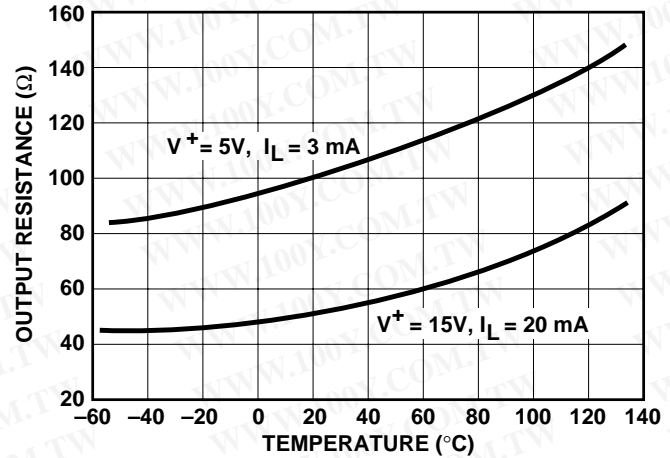

Power Conversion Efficiency vs. I<sub>LOAD</sub>

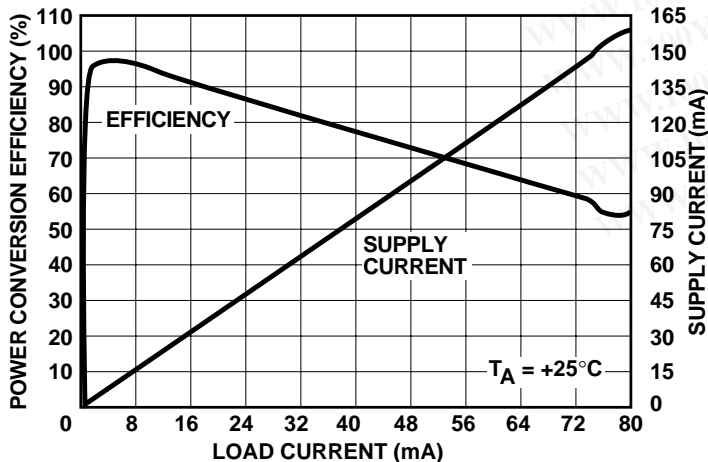

Output Resistance vs. Input Voltage

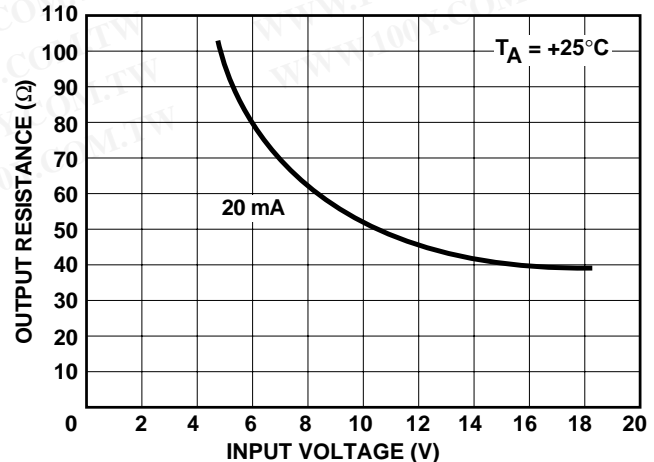

4