

## 1.2A DUAL HIGH-SPEED MOSFET DRIVERS

### FEATURES

- Low Cost
- Latch-Up Protected: Will Withstand 500 mA Reverse Output Current
- ESD Protected ..... ±2 kV
- High Peak Output Current..... 1.2A Peak
- High Capacitive Load Drive Capability ..... 1000pF in 38nsec
- Wide Operating Range ..... 4.5V to 16V
- Low Delay Time ..... 75nsec Max
- Logic Input Threshold Independent of Supply Voltage
- Output Voltage Swing to Within 25mV of Ground or V<sub>DD</sub>
- Low Output Impedance ..... 8Ω

### APPLICATIONS

- Power MOSFET Drivers
- Switched Mode Power Supplies
- Pulse Transformer Drive
- Small Motor Controls
- Print Head Drive

### PIN CONFIGURATIONS

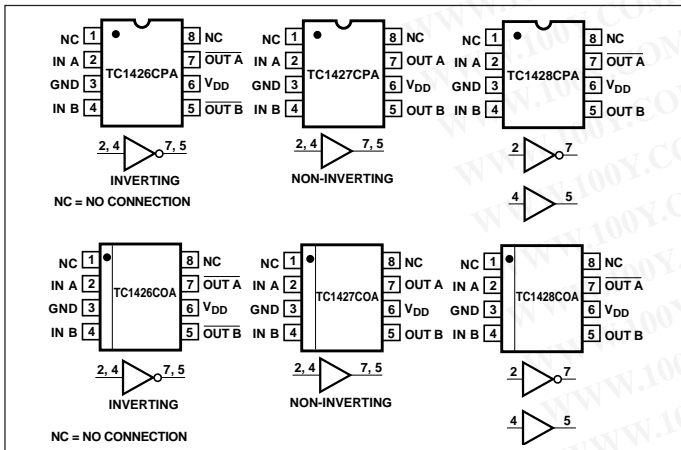

### FUNCTIONAL BLOCK DIAGRAM

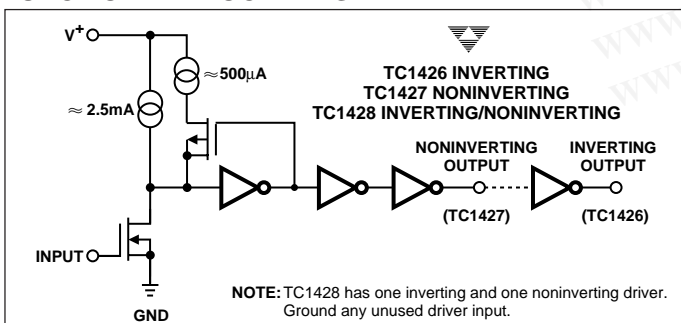

### GENERAL DESCRIPTION

The TC1426/27/28 are a family of 1.2A dual high-speed drivers. CMOS fabrication is used for low power consumption and high efficiency.

These devices are fabricated using an epitaxial layer to effectively short out the intrinsic parasitic transistor responsible for CMOS latch-up. They incorporate a number of other design and process refinements to increase their long-term reliability.

The TC1426 is compatible with the bipolar DS0026, but only draws 1/5 of the quiescent current. The TC1426/27/28 are also compatible with the TC426/27/28, but with 1.2A peak output current rather than the 1.5A of the TC426/27/28 devices.

Other compatible drivers are the TC4426/27/28 and the TC4426A/27A/28A. The TC4426/27/28 have the added feature that the inputs can withstand negative voltage up to 5V with diode protection circuits. The TC4426A/27A/28A have matched input to output leading edge and falling edge delays, tD1 and tD2, for processing short duration pulses in the 25 nanoseconds range. All of the above drivers are pin compatible.

The high-input impedance TC1426/27/28 drivers are CMOS/TTL input-compatible, do not require the speed-up needed by the bipolar devices, and can be directly driven by most PWM ICs.

This family of devices is available in inverting and non-inverting versions. Specifications have been optimized to achieve low-cost and high-performance devices, well-suited for the high-volume manufacturer.

### ORDERING INFORMATION

Part No.	Package	Temp. Range
TC1426COA	8-Pin SOIC	0°C to +70°C
TC1426CPA	8-Pin Plastic DIP	0°C to +70°C
TC1427COA	8-Pin SOIC	0°C to +70°C
TC1427CPA	8-Pin Plastic DIP	0°C to +70°C
TC1428COA	8-Pin SOIC	0°C to +70°C
TC1428CPA	8-Pin Plastic DIP	0°C to +70°C

## 1.2A DUAL HIGH-SPEED MOSFET DRIVERS

TC1426  
TC1427  
TC1428

勝特力材料 886-3-5753170  
勝特力电子(上海) 86-21-54151736  
勝特力电子(深圳) 86-755-83298787  
[Http://www.100y.com.tw](http://www.100y.com.tw)

### ABSOLUTE MAXIMUM RATINGS\*

Power Dissipation ( $T_A \leq 70^\circ\text{C}$ )	
Plastic DIP	730W
SOIC	470 mW
Derating Factor	
Plastic DIP	8 mW/ $^\circ\text{C}$
SOIC	4 mW/ $^\circ\text{C}$
Supply Voltage	18V
Input Voltage, Any Terminal .. ( $V_{DD} + 0.3\text{V}$ ) to ( $\text{GND} - 0.3\text{V}$ )	
Operating Temperature: C Version	$0^\circ\text{C}$ to $+70^\circ\text{C}$
E Version	$-40^\circ\text{C}$ to $+85^\circ\text{C}$

Maximum Chip Temperature	$+150^\circ\text{C}$
Storage Temperature	$+65^\circ\text{C}$ to $+150^\circ\text{C}$
Lead Temperature (Soldering, 10 sec)	$+300^\circ\text{C}$

\*Stresses above those listed under "Absolute Maximum Ratings" may cause permanent damage to the device. These are stress ratings only, and functional operation of the device at these or any other conditions above those indicated in the operational sections of the specifications is not implied. Exposure to absolute maximum rating conditions for extended periods may affect device reliability.

### ELECTRICAL CHARACTERISTICS: $T_A = 25^\circ\text{C}$ with $4.5\text{V} \leq V_{DD} \leq 16\text{V}$ unless otherwise specified.

Symbol	Parameter	Test Conditions	Min	Typ	Max	Unit
<b>Input</b>						
$V_{IH}$		Logic 1, Input Voltage	3	—	—	V
$V_{IL}$		Logic 0, Input Voltage	—	—	0.8	V
$I_{IN}$	Input Current	$0\text{V} \leq V_{IN} \leq V_{DD}$	-1	—	1	$\mu\text{A}$
<b>Output</b>						
$V_{OH}$	High Output Voltage	Test Figures 1 and 2	$V_{DD} - 0.025$	—	—	V
$V_{OL}$	Low Output Voltage	Test Figures 1 and 2	—	—	0.025	V
$R_O$	Output Resistance	$V_{IN} = 0.8\text{V}$ , $I_{OUT} = 10\text{ mA}$ , $V_{DD} = 16\text{V}$ $V_{IN} = 3\text{V}$ , $I_{OUT} = 10\text{ mA}$ , $V_{DD} = 16\text{V}$	—	12	18	$\Omega$
$I_{PK}$	Peak Output Current		—	1.2	—	A
I	Latch-Up Current	Withstand Reverse Current	> 500	—	—	mA
<b>Switching Time (Note 1)</b>						
$t_R$	Rise Time	Test Figures 1 and 2	—	—	35	nsec
$t_F$	Fall Time	Test Figures 1 and 2	—	—	25	nsec
$t_{D1}$	Delay Time	Test Figures 1 and 2	—	—	75	nsec
$t_{D2}$	Delay Time	Test Figures 1 and 2	—	—	75	nsec
<b>Power Supply</b>						
$I_S$	Power Supply Current	$V_{IN} = 3\text{V}$ (Both Inputs) $V_{IN} = 0\text{V}$ (Both Inputs)	—	—	9	mA
			—	—	0.5	

Note: 1. Switching times guaranteed by design.

## 1.2A DUAL HIGH-SPEED MOSFET DRIVERS

勝特力材料 886-3-5753170  
 勝特力电子(上海) 86-21-54151736  
 勝特力电子(深圳) 86-755-83298787  
[Http://www.100y.com.tw](http://www.100y.com.tw)

TC1426  
 TC1427  
 TC1428

**ELECTRICAL CHARACTERISTICS:** Over operating temperature range with  $4.5V \leq V_{DD} \leq 16V$  unless otherwise specified.

Symbol	Parameter	Test Conditions	Min	Typ	Max	Unit
<b>Input</b>						
$V_{IH}$	Logic 1, Input Voltage		3	—	—	V
$V_{IL}$	Logic 0, Input Voltage		—	—	0.8	V
$I_{IN}$	Input Current	$0V \leq V_{IN} \leq V_{DD}$	-10	—	10	$\mu A$
<b>Output</b>						
$V_{OH}$	High Output Voltage	Test Figures 1 and 2	$V_{DD} - 0.025$	—	—	V
$V_{OL}$	Low Output Voltage	Test Figures 1 and 2	—	—	0.025	V
$R_O$	Output Resistance	$V_{IN} = 0.8V,$ $I_{OUT} = 10mA, V_{DD} = 16V$ $V_{IN} = 3V,$ $I_{OUT} = 10mA, V_{DD} = 16V$	—	15	23	$\Omega$
I	Latch-Up Current	Withstand Reverse Current	> 500	—	—	mA
<b>Switching Time (Note 1)</b>						
$t_R$	Rise Time	Test Figures 1 and 2	—	—	60	nsec
$t_F$	Fall Time	Test Figures 1 and 2	—	—	40	nsec
$t_{D1}$	Delay Time	Test Figures 1 and 2	—	—	125	nsec
$t_{D2}$	Delay Time	Test Figures 1 and 2	—	—	125	nsec
<b>Power Supply</b>						
$I_S$	Power Supply Current	$V_{IN} = 3V$ (Both Inputs) $V_{IN} = 0V$ (Both Inputs)	—	—	13	mA
			—	—	0.7	

**Note:** 1. Switching times guaranteed by design.

### SUPPLY BYPASSING

Large currents are required to charge and discharge capacitive loads quickly. For example, charging a 1000-pF load to 16V in 25nsec requires an 0.8A current from the device power supply.

To guarantee low supply impedance over a wide frequency range, a parallel capacitor combination is recommended for supply bypassing. Low-inductance ceramic MLC capacitors with short lead lengths (< 0.5-in.) should be used. A 1.0- $\mu F$  film capacitor in parallel with one or two 0.1- $\mu F$  ceramic MLC capacitors normally provides adequate bypassing.

### GROUNDING

The TC1426 and TC1428 contain inverting drivers. Individual ground returns for the input and output circuits or a ground plane should be used. This will reduce negative feedback that causes degradation in switching speed characteristics.

### INPUT STAGE

The input voltage level changes the no-load or quiescent supply current. The N-channel MOSFET input stage transistor drives a 2.5 mA current source load. With a logic "1" input, the maximum quiescent supply current is 9mA. Logic "0" input level signals reduce quiescent current to 500  $\mu A$  maximum. **Unused driver inputs must be connected to  $V_{DD}$  or GND.** Minimum power dissipation occurs for logic "0" inputs for the TC1426/27/28.

The drivers are designed with 100 mV of hysteresis. This provides clean transitions and minimizes output stage current spiking when changing states. Input voltage thresholds are approximately 1.5V, making logic "1" input any voltage greater than 1.5V up to  $V_{DD}$ . Input current is less than 1 $\mu A$  over this range.

The TC1426/27/28 may be directly driven by the TL494, SG1526/27, TC38C42, TC170 and similar switch-mode power supply integrated circuits.

4

## 1.2A DUAL HIGH-SPEED MOSFET DRIVERS

TC1426  
TC1427  
TC1428

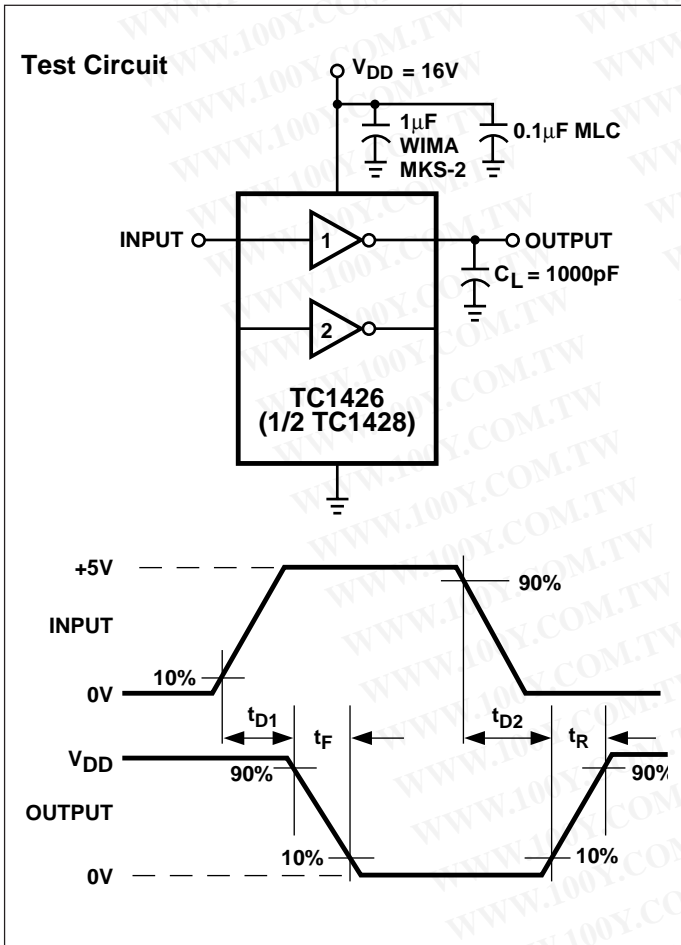

Figure 1. Inverting Driver Switching Time

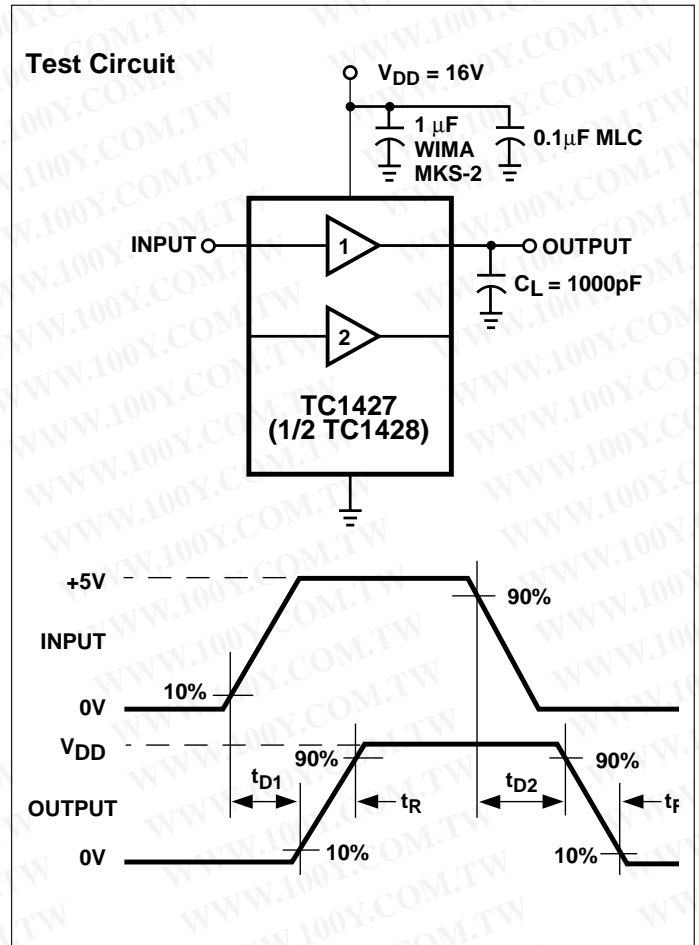

Figure 2. Non-Inverting Driver Switching Time

勝特力材料 886-3-5753170  
 勝特力电子(上海) 86-21-54151736  
 勝特力电子(深圳) 86-755-83298787  
[Http://www.100y.com.tw](http://www.100y.com.tw)

# 1.2A DUAL HIGH-SPEED MOSFET DRIVERS

勝特力材料 886-3-5753170  
 勝特力电子(上海) 86-21-54151736  
 勝特力电子(深圳) 86-755-83298787  
[Http://www.100y.com.tw](http://www.100y.com.tw)

TC1426  
 TC1427  
 TC1428

## TYPICAL CHARACTERISTICS

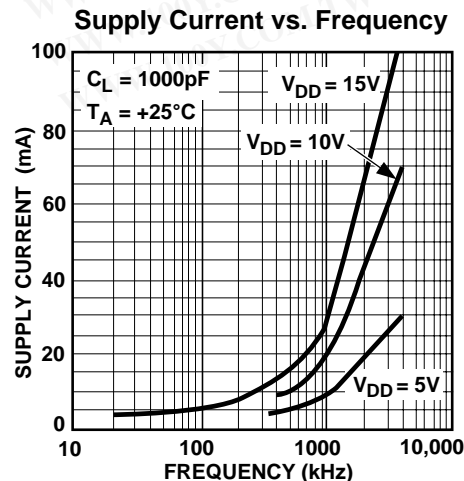
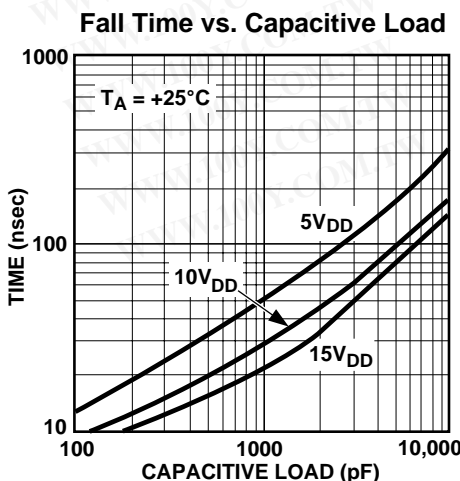
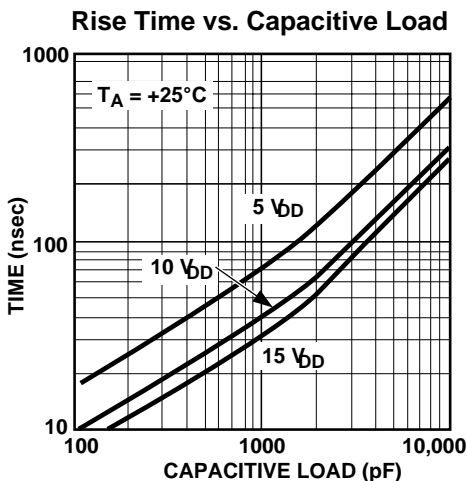
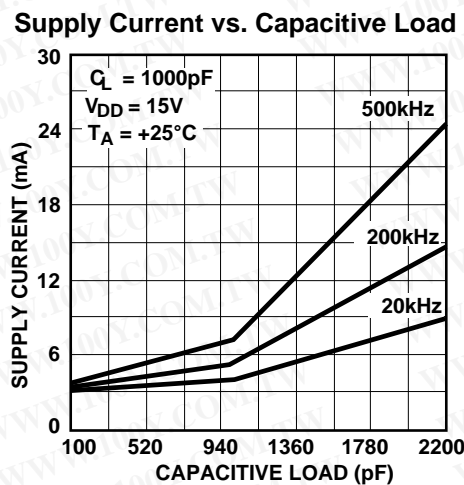
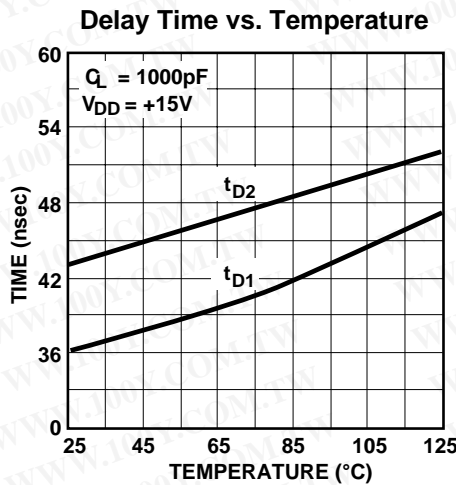
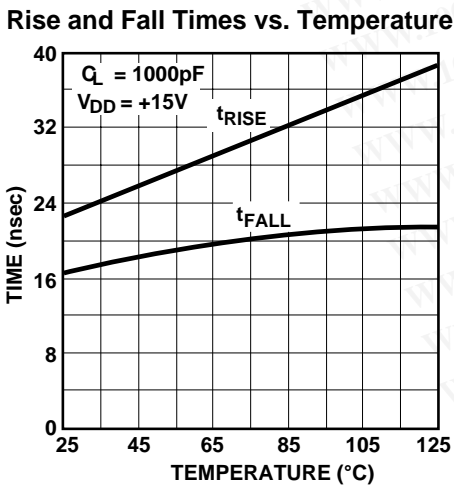
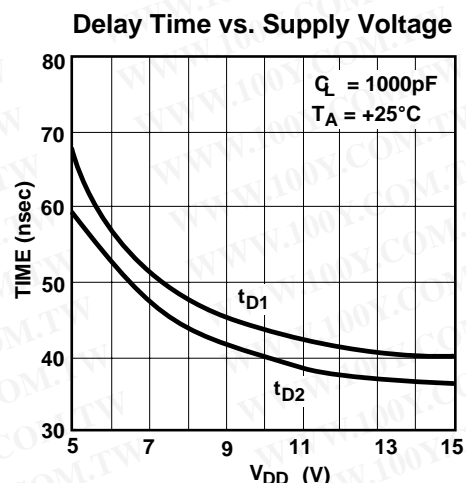
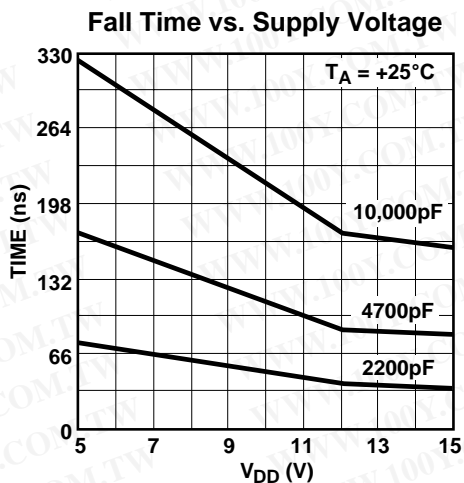
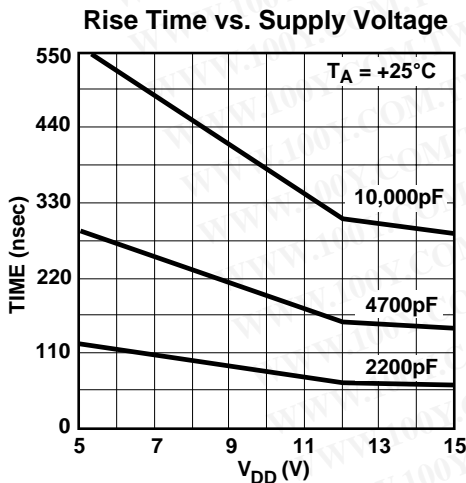

4

# 1.2A DUAL HIGH-SPEED MOSFET DRIVERS

TC1426  
TC1427  
TC1428

## TYPICAL CHARACTERISTIC (Cont.)

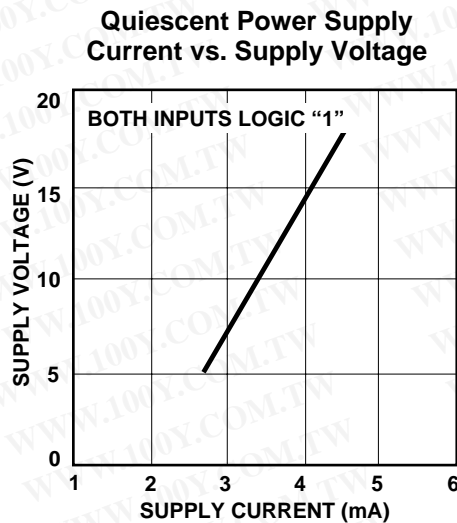
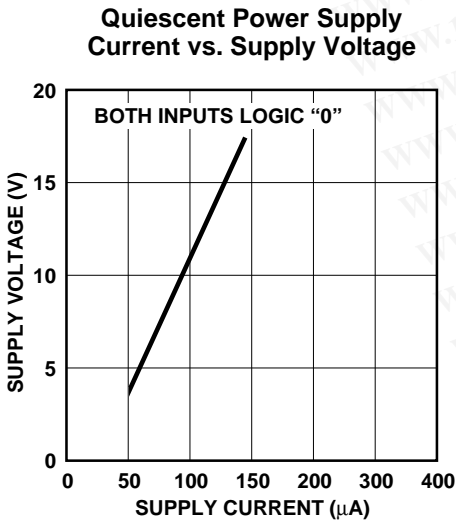
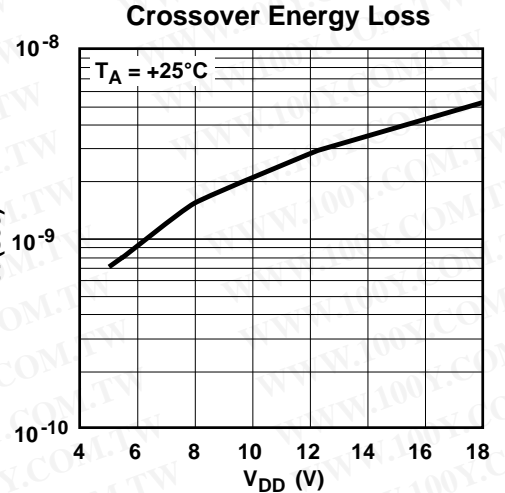
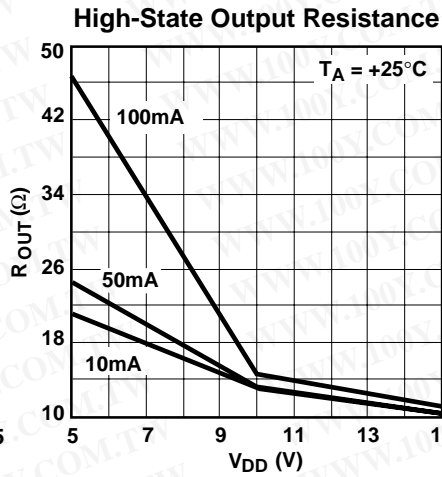
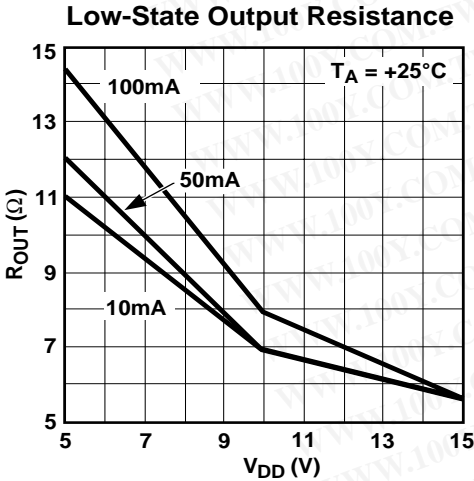

勝特力材料 886-3-5753170  
 勝特力电子(上海) 86-21-54151736  
 勝特力电子(深圳) 86-755-83298787  
[Http://www.100y.com.tw](http://www.100y.com.tw)

