

# SN75159 DUAL DIFFERENTIAL LINE DRIVER WITH 3-STATE OUTPUTS

SLLS088B – JANUARY 1977 – REVISED MAY 1995

- Meets or Exceeds the Requirements of ANSI EIA/TIA-422-B and ITU Recommendation V.11
- Single 5-V Supply
- Balanced Line Operation
- TTL Compatible
- High-Impedance Output State for Party-Line Applications
- High-Current Active-Pullup Outputs
- Short-Circuit Protection
- Dual Channels
- Clamp Diodes at Inputs

**D OR N PACKAGE  
(TOP VIEW)**

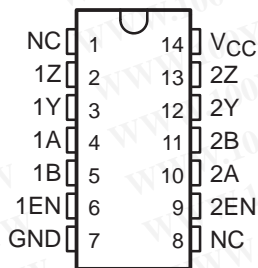

NC—No internal connection

## description

The SN75159 dual differential line driver with 3-state outputs is designed to provide all the features of the SN75158 line driver with the added feature of driver output controls. There is an individual control for each driver. When the output control is low, the associated outputs are in a high-impedance state and the outputs can neither drive nor load the bus. This permits many devices to be connected together on the same transmission line for party-line applications.

The SN75159 is characterized for operation from 0°C to 70°C.

## logic symbol†

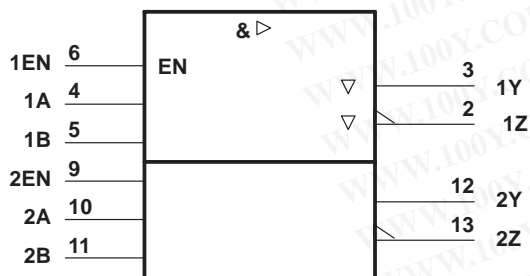

† This symbol is in accordance with ANSI/IEEE Std 91-1984 and IEC Publication 617-12.

## logic diagram (positive logic)

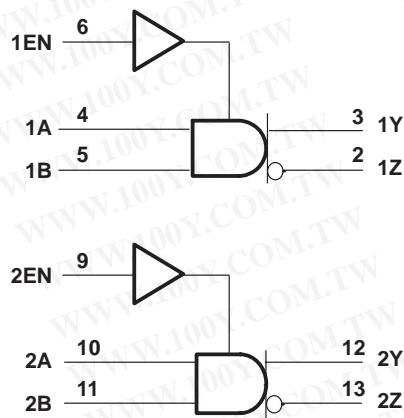

勝特力材料 886-3-5753170  
 勝特力电子(上海) 86-21-54151736  
 勝特力电子(深圳) 86-755-83298787  
[Http://www.100y.com.tw](http://www.100y.com.tw)



Please be aware that an important notice concerning availability, standard warranty, and use in critical applications of Texas Instruments semiconductor products and disclaimers thereto appears at the end of this data sheet.

PRODUCTION DATA information is current as of publication date. Products conform to specifications per the terms of Texas Instruments standard warranty. Production processing does not necessarily include testing of all parameters.

**TEXAS  
INSTRUMENTS**

POST OFFICE BOX 655303 • DALLAS, TEXAS 75265

Copyright © 1995, Texas Instruments Incorporated

# SN75159 DUAL DIFFERENTIAL LINE DRIVER WITH 3-STATE OUTPUTS

SLLS088B – JANUARY 1977 – REVISED MAY 1995

## schematic (each driver)

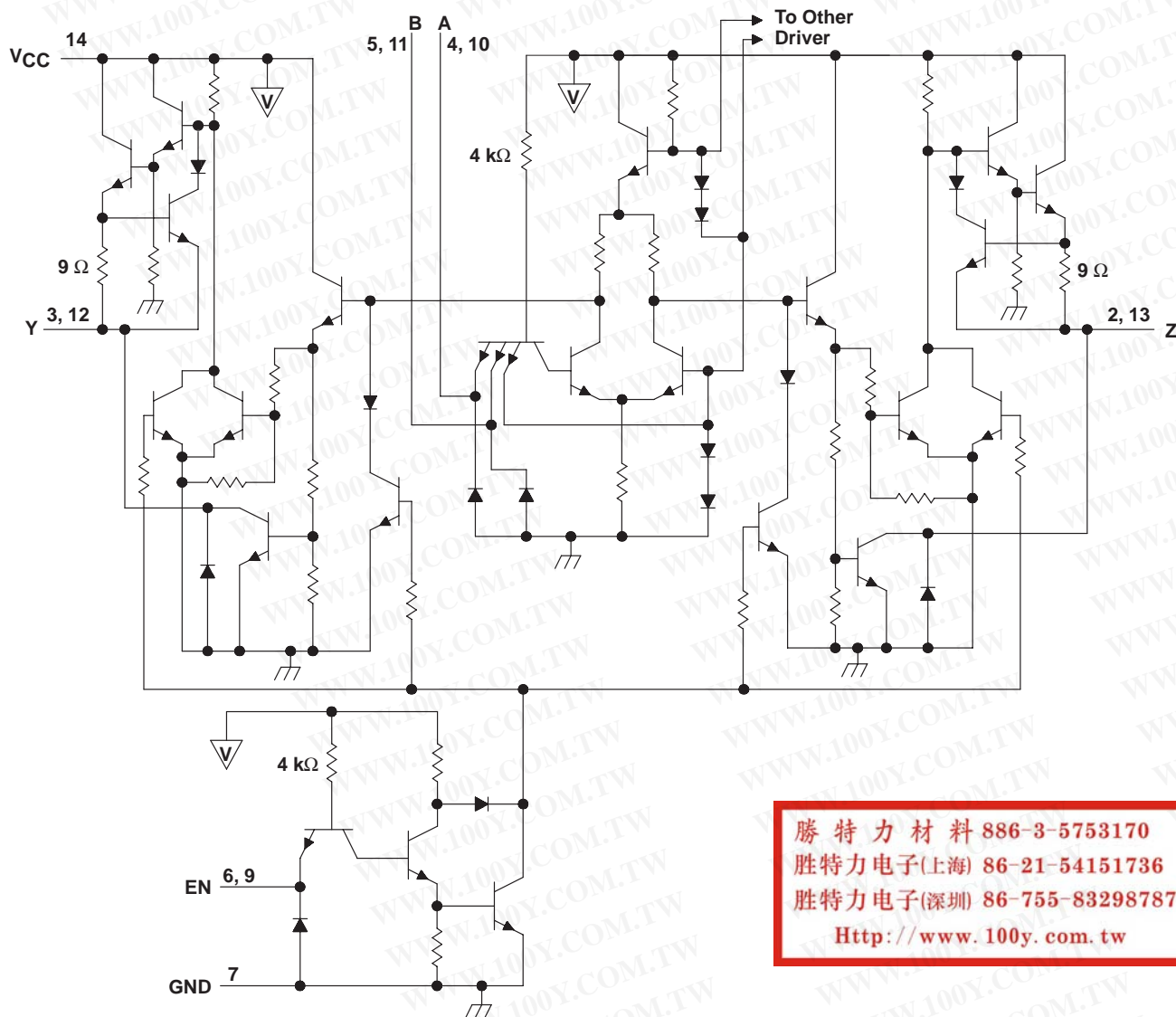

 ... VCC bus

Resistor values shown are nominal.

勝特力材料 86-3-5753170  
 勝特力电子(上海) 86-21-54151736  
 勝特力电子(深圳) 86-755-83298787  
[Http://www.100y.com.tw](http://www.100y.com.tw)

**SN75159**  
**DUAL DIFFERENTIAL LINE DRIVER**  
**WITH 3-STATE OUTPUTS**

SLLS088B – JANUARY 1977 – REVISED MAY 1995

**absolute maximum ratings over operating free-air temperature range (unless otherwise noted)†**

Supply voltage, $V_{CC}$ (see Note 1)	7 V
Input voltage, $V_I$	5.5 V
Off-state voltage applied to open-collector outputs	12 V
Continuous total dissipation	See Dissipation Rating Table
Operating free-air temperature range, $T_A$	0°C to 70°C
Storage temperature range, $T_{stg}$	-65°C to 150°C
Lead temperature 1,6 mm (1/16 inch) from case for 10 seconds	260°C

† Stresses beyond those listed under “absolute maximum ratings” may cause permanent damage to the device. These are stress ratings only, and functional operation of the device at these or any other conditions beyond those indicated under “recommended operating conditions” is not implied. Exposure to absolute-maximum-rated conditions for extended periods may affect device reliability.

NOTE 1: All voltage values except differential output voltage  $V_{OD}$  are with respect to the network ground terminal.  $V_{OD}$  is at the Y output with respect to the Z output.

**DISSIPATION RATING TABLE**

PACKAGE	$T_A \leq 25^\circ\text{C}$ POWER RATING	DERATING FACTOR ABOVE $T_A = 25^\circ\text{C}$	$T_A = 70^\circ\text{C}$ POWER RATING
D	950 mW	7.6 mW/°C	608 mW
N	1150 mW	9.2 mW/°C	736 mW

**recommended operating conditions**

	MIN	NOM	MAX	UNIT
Supply voltage, $V_{CC}$	4.75	5	5.25	V
High-level input voltage, $V_{IH}$	2			V
Low-level input voltage, $V_{IL}$			0.8	V
High-level output voltage, $I_{OH}$			-40	mA
Low-level output current, $I_{OL}$			40	mA
Operating free-air temperature, $T_A$	0		70	°C

勝特力材料 886-3-5753170  
 勝特力电子(上海) 86-21-54151736  
 勝特力电子(深圳) 86-755-83298787  
[Http://www.100y.com.tw](http://www.100y.com.tw)



# SN75159 DUAL DIFFERENTIAL LINE DRIVER WITH 3-STATE OUTPUTS

SLLS088B – JANUARY 1977 – REVISED MAY 1995

## electrical characteristics over operating free-air temperature range (unless otherwise noted)

PARAMETER		TEST CONDITIONS		MIN	TYP†	MAX	UNIT
V <sub>IK</sub>	Input clamp voltage	V <sub>CC</sub> = 4.75 V,	I <sub>I</sub> = -12 mA		-0.9	-1.5	V
V <sub>OH</sub>	High-level output voltage	V <sub>CC</sub> = 4.75 V, V <sub>IH</sub> = 2 V,	V <sub>IL</sub> = 0.8 V, I <sub>OH</sub> = -40 mA	2.4	3		V
V <sub>OL</sub>	Low-level output voltage	V <sub>CC</sub> = 4.75 V, V <sub>IH</sub> = 2 V,	V <sub>IL</sub> = 0.8 V, I <sub>OL</sub> = 40 mA		0.25	0.4	V
V <sub>O</sub> K	Output clamp voltage	V <sub>CC</sub> = 5.25 V,	I <sub>O</sub> = -40 mA		-1.1	-1.5	V
V <sub>O</sub>	Output voltage	V <sub>CC</sub> = 4.75 V to 5.25 V,	I <sub>O</sub> = 0	0		6	V
V <sub>OD1</sub>	Differential output voltage	V <sub>CC</sub> = 5.25 V,	I <sub>O</sub> = 0		3.5	2V <sub>OD2</sub>	V
V <sub>OD2</sub>	Differential output voltage	V <sub>CC</sub> = 4.75 V		2	3		V
Δ V <sub>OD</sub>	Change in magnitude of differential output voltage‡	V <sub>CC</sub> = 4.75 V			±0.02	±0.4	V
V <sub>OC</sub>	Common-mode output voltage§	V <sub>CC</sub> = 5.25 V	R <sub>L</sub> = 100 Ω, See Figure 1		1.8	3	V
		V <sub>CC</sub> = 4.75 V			1.5	3	
Δ V <sub>OC</sub>	Change in magnitude of common-mode output voltage‡	V <sub>CC</sub> = 4.75 V to 5.25 V				±0.01	±0.4
I <sub>O</sub>	Output current with power off	V <sub>CC</sub> = 0	V <sub>O</sub> = 6 V		0.1	100	μA
			V <sub>O</sub> = -0.25 V		-0.1	-100	
			V <sub>O</sub> = -0.25 V to 6 V			±100	
I <sub>OZ</sub>	Off-state (high-impedance state) output current	V <sub>CC</sub> = 5.25 V, Output controls at 0.8 V	T <sub>A</sub> = 25°C	V <sub>O</sub> = 0 to V <sub>CC</sub>		±10	μA
				V <sub>O</sub> = 0		-20	
			T <sub>A</sub> = 70°C	V <sub>O</sub> = 0.4 V		±20	
				V <sub>O</sub> = 2.4 V		±20	
				V <sub>O</sub> = V <sub>CC</sub>		20	
I <sub>I</sub>	Input current at maximum input voltage	V <sub>CC</sub> = 5.25 V,	V <sub>I</sub> = 5.5 V			1	mA
I <sub>IH</sub>	High-level input current	V <sub>CC</sub> = 5.25 V,	V <sub>I</sub> = 2.4 V			40	μA
I <sub>IL</sub>	Low-level input current	V <sub>CC</sub> = 5.25 V,	V <sub>I</sub> = 0.4 V		-1	-1.6	mA
I <sub>OS</sub>	Short-circuit output current¶	V <sub>CC</sub> = 5.25 V		-40	-90	-150	mA
I <sub>CC</sub>	Supply current (both drivers)	V <sub>CC</sub> = 5.25 V, T <sub>A</sub> = 25°C,	Inputs grounded, No load		47	65	mA

† All typical values are at V<sub>CC</sub> = 5 V and T<sub>A</sub> = 25°C except for V<sub>OC</sub>, for which V<sub>CC</sub> is as stated under test conditions.

‡ Δ|V<sub>OD</sub>| and Δ|V<sub>OC</sub>| are the changes in magnitudes of V<sub>OD</sub> and V<sub>OC</sub>, respectively, that occur when the input is changed from a high level to a low level.

§ In ANSI Standard EIA/TIA-422-B, V<sub>OC</sub>, which is the average of the two output voltages with respect to GND, is called output offset voltage, V<sub>OS</sub>.

¶ Only one output should be shorted at a time, and duration of the short circuit should not exceed one second.

**勝特力材料 886-3-5753170**  
**勝特力电子(上海) 86-21-54151736**  
**勝特力电子(深圳) 86-755-83298787**  
[Http://www.100y.com.tw](http://www.100y.com.tw)



# SN75159 DUAL DIFFERENTIAL LINE DRIVER WITH 3-STATE OUTPUTS

SLLS088B – JANUARY 1977 – REVISED MAY 1995

## switching characteristics over operating free-air temperature range, $V_{CC} = 5\text{ V}$

PARAMETER	TEST CONDITIONS	MIN	TYP†	MAX	UNIT
$t_{PLH}$ Propagation delay time, low-to-high-level output	$C_L = 30\text{ pF}$ , $R_L = 100\ \Omega$ , See Figure 2, Termination A		16	25	ns
$t_{PHL}$ Propagation delay time, high-to-low-level output			11	20	ns
$t_{PLH}$ Propagation delay time, low-to-high-level output	$C_L = 15\text{ pF}$ , See Figure 2, Termination B		13	20	ns
$t_{PHL}$ Propagation delay time, high-to-low-level output			9	15	ns
$t_{TLH}$ Transition time, low-to-high-level output	$C_L = 30\text{ pF}$ , $R_L = 100\ \Omega$ , See Figure 2, Termination A		4	20	ns
$t_{THL}$ Transition time, high-to-low-level output			4	20	ns
$t_{PZH}$ Output enable time to high level	$C_L = 30\text{ pF}$ , $R_L = 180\ \Omega$ , See Figure 3		7	20	ns
$t_{PZL}$ Output enable time to low level	$C_L = 30\text{ pF}$ , $R_L = 250\ \Omega$ , See Figure 4		14	40	ns
$t_{PHZ}$ Output disable time from high level	$C_L = 30\text{ pF}$ , $R_L = 180\ \Omega$ , See Figure 3		10	30	ns
$t_{PLZ}$ Output disable time from low level	$C_L = 30\text{ pF}$ , $R_L = 250\ \Omega$ , See Figure 4		17	35	ns
Overshoot factor	$R_L = 100\ \Omega$ , See Figure 2, Termination C			10%	

† All typical values are at  $T_A = 25^\circ\text{C}$ .

### SYMBOL EQUIVALENTS

DATA-SHEET PARAMETER	EIA/TIA-422-B
$V_O$	$V_{oa}, V_{ob}$
$ V_{OD1} $	$V_o$
$ V_{OD2} $	$V_t$
$\Delta V_{OD} $	$  V_t  -  \bar{V}_t  $
$V_{OC}$	$ V_{os} $
$\Delta V_{OC} $	$ V_{os} - \bar{V}_{os} $
$I_{OS}$	$ I_{sa} ,  I_{sb} $
$I_O$	$ I_{xa} ,  I_{xb} $

### PARAMETER MEASUREMENT INFORMATION

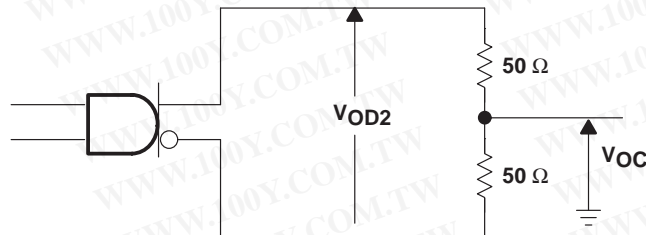

Figure 1. Differential and Common-Mode Output Voltages

勝特力材料 886-3-5753170  
 勝特力电子(上海) 86-21-54151736  
 勝特力电子(深圳) 86-755-83298787  
[Http://www.100y.com.tw](http://www.100y.com.tw)

**SN75159**  
**DUAL DIFFERENTIAL LINE DRIVER**  
**WITH 3-STATE OUTPUTS**

SLLS088B – JANUARY 1977 – REVISED MAY 1995

勝特力材料 886-3-5753170  
 勝特力电子(上海) 86-21-54151736  
 勝特力电子(深圳) 86-755-83298787  
[Http://www.100y.com.tw](http://www.100y.com.tw)

**PARAMETER MEASUREMENT INFORMATION**

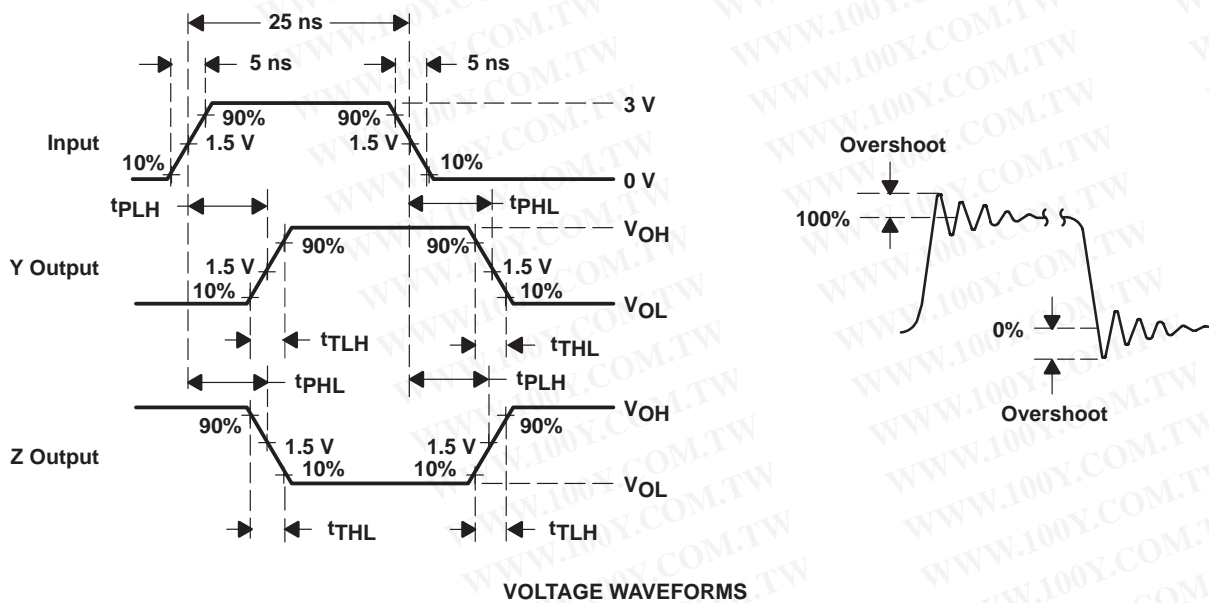
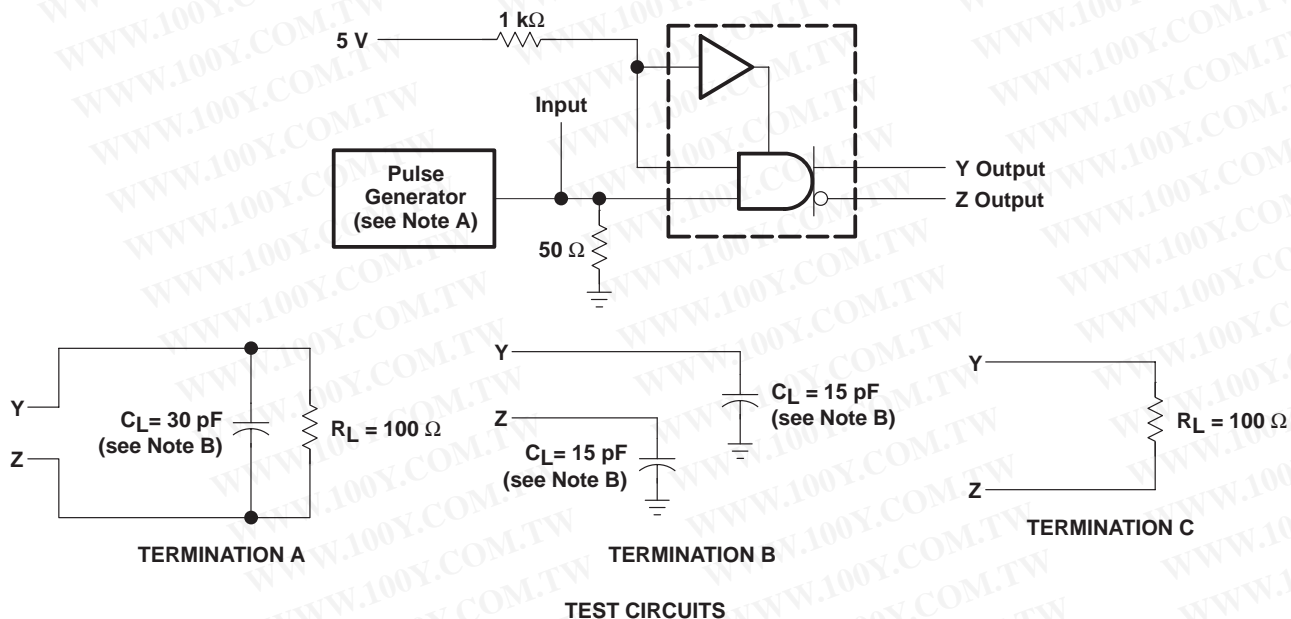

- NOTES: A. The pulse generator has the following characteristics: Z<sub>O</sub> = 50 Ω, PRR ≤ 10 MHz.  
 B. C<sub>L</sub> includes probe and jig capacitance.

**Figure 2. Test Circuits, Voltage Waveforms, and Overshoot Factor**



**PARAMETER MEASUREMENT INFORMATION**

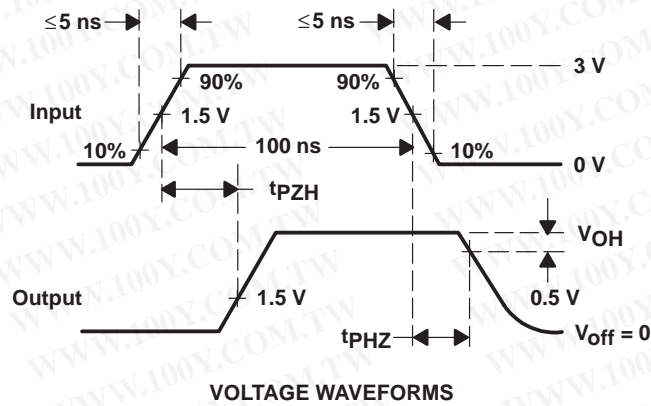
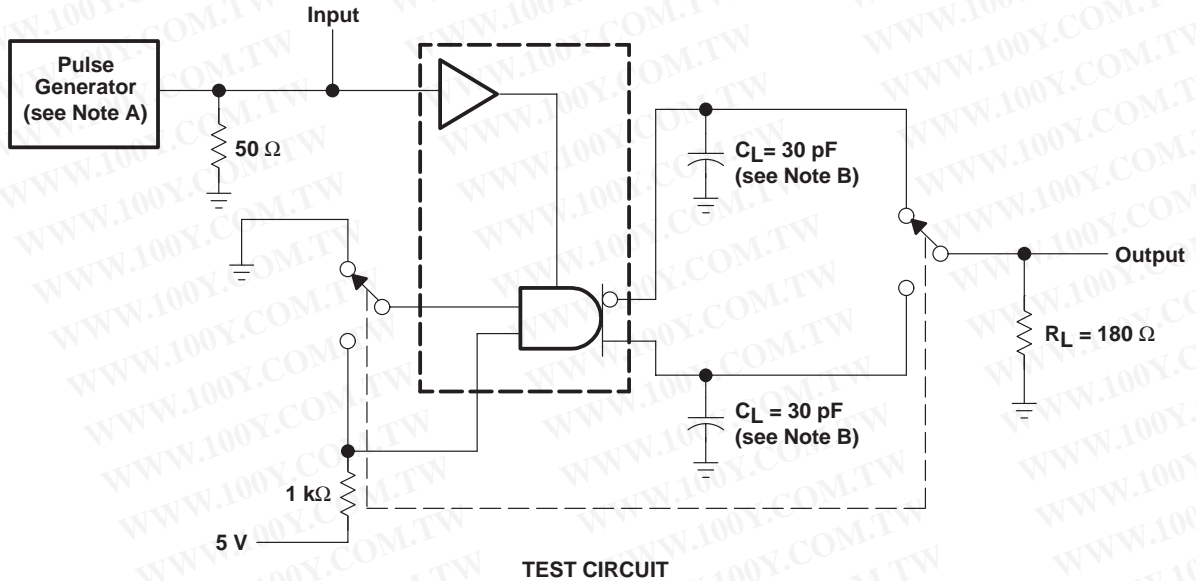

- NOTES: A. The pulse generator has the following characteristics:  $Z_O = 50 \Omega$ ,  $PRR \leq 500 \text{ kHz}$ .  
 B.  $C_L$  includes probe and jig capacitance.

**Figure 3. Test Circuit and Voltage Waveforms**

**SN75159**  
**DUAL DIFFERENTIAL LINE DRIVER**  
**WITH 3-STATE OUTPUTS**

SLLS088B – JANUARY 1977 – REVISED MAY 1995

勝特力材料 886-3-5753170  
 勝特力电子(上海) 86-21-54151736  
 勝特力电子(深圳) 86-755-83298787  
[Http://www.100y.com.tw](http://www.100y.com.tw)

**PARAMETER MEASUREMENT INFORMATION**

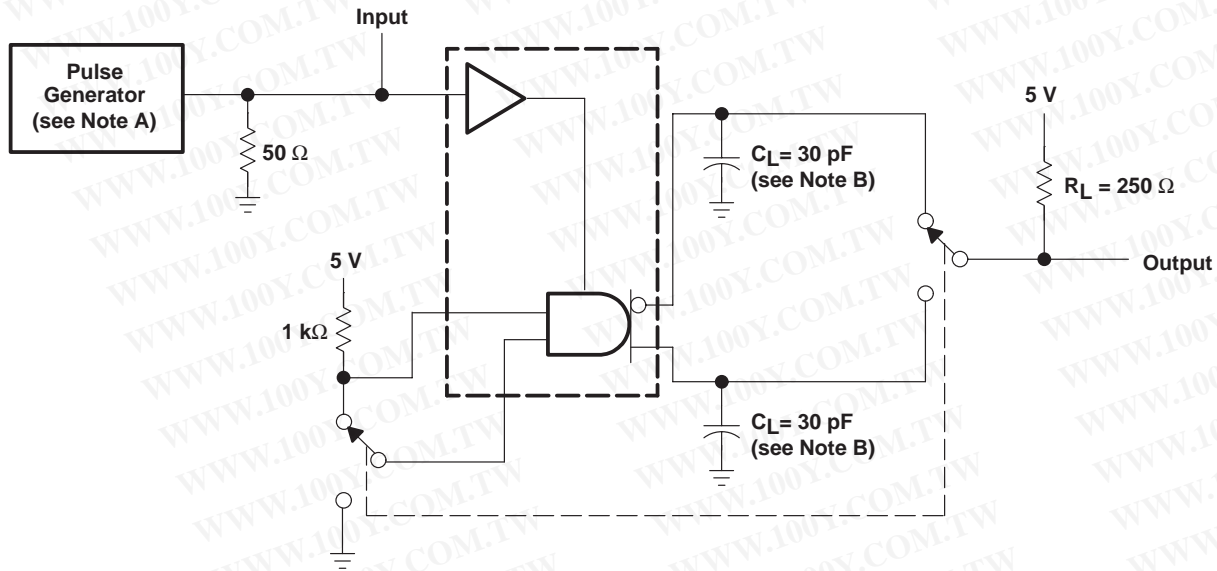

**TEST CIRCUIT**

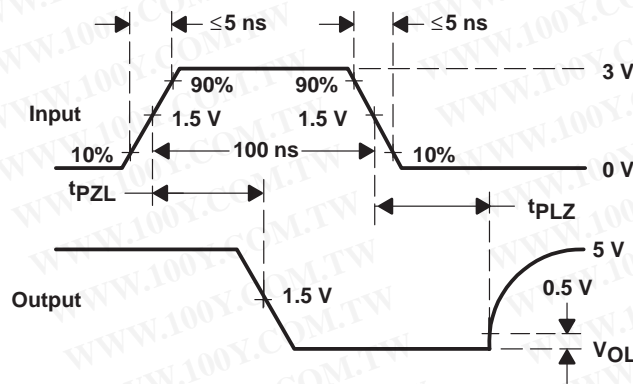

**VOLTAGE WAVEFORMS**

- NOTES: A. The pulse generator has the following characteristics:  $Z_O = 50 \Omega$ ,  $PRR \leq 500 \text{ kHz}$ .  
 B.  $C_L$  includes probe and jig capacitance.

**Figure 4. Test Circuit and Voltage Waveform**

TYPICAL CHARACTERISTICS

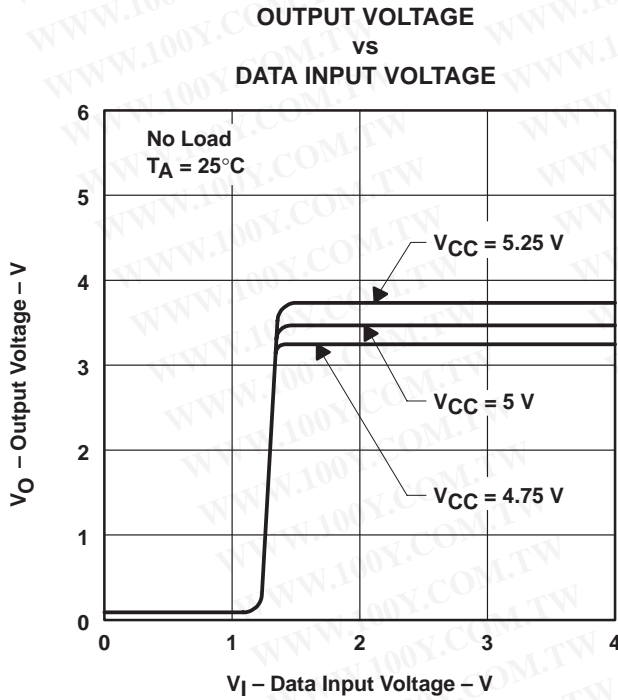

Figure 5

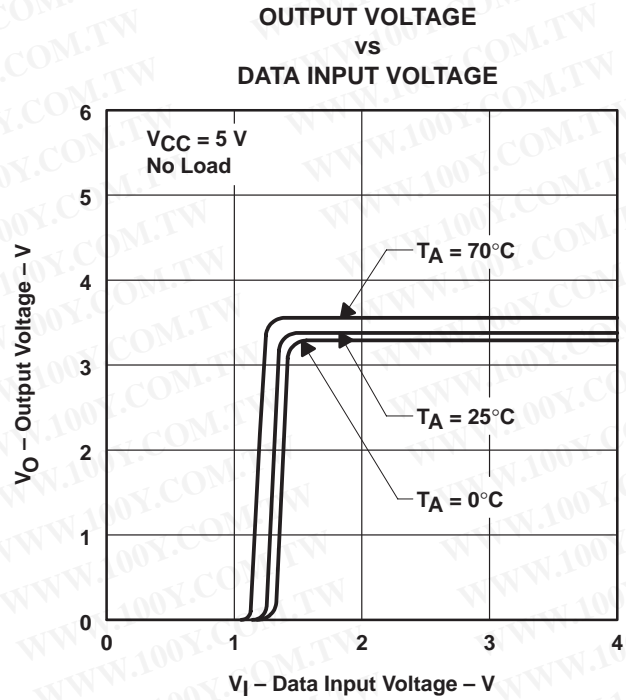

Figure 6

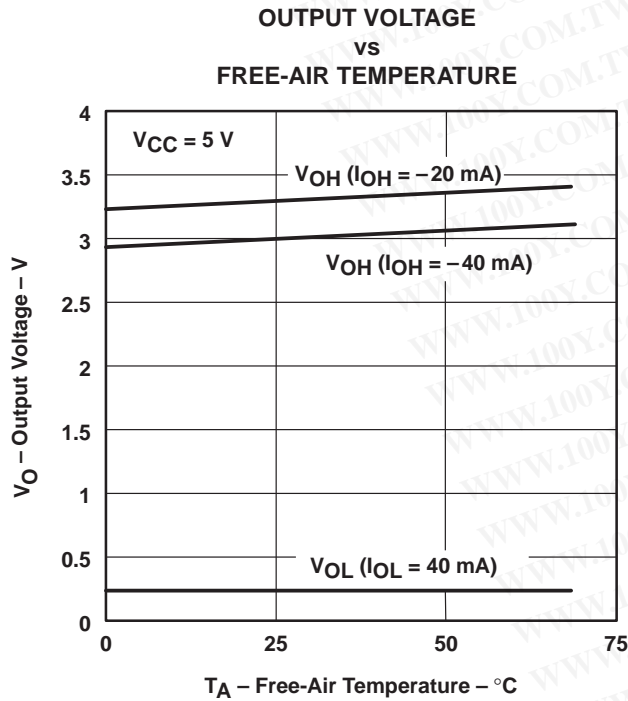

Figure 7

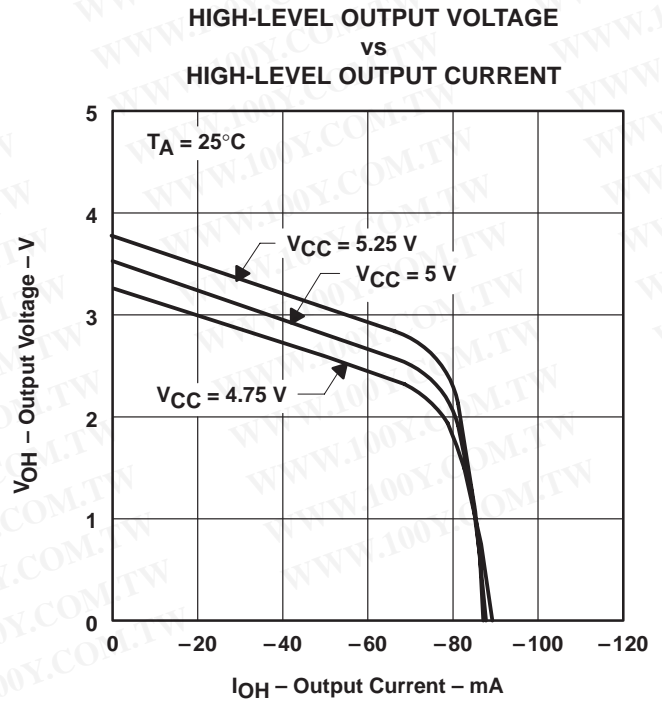

Figure 8

**SN75159**  
**DUAL DIFFERENTIAL LINE DRIVER**  
**WITH 3-STATE OUTPUTS**

SLLS088B – JANUARY 1977 – REVISED MAY 1995

勝特力材料 886-3-5753170  
 勝特力电子(上海) 86-21-54151736  
 勝特力电子(深圳) 86-755-83298787  
[Http://www.100y.com.tw](http://www.100y.com.tw)

**TYPICAL CHARACTERISTICS**

**LOW-LEVEL OUTPUT VOLTAGE**  
**vs**  
**LOW-LEVEL OUTPUT CURRENT**

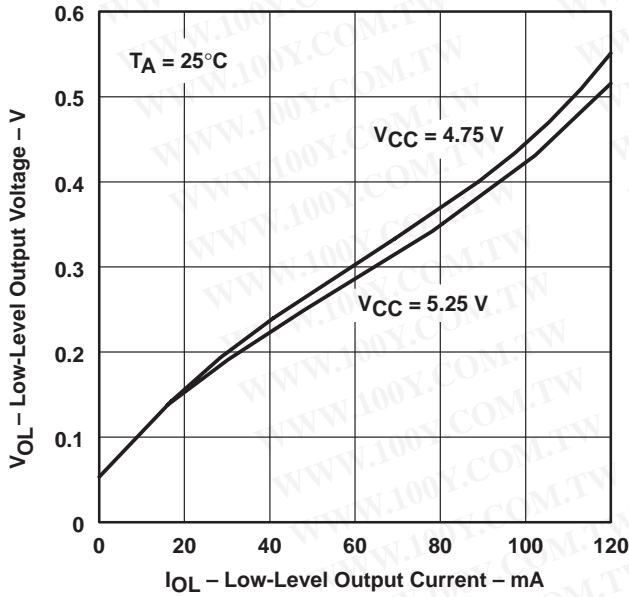

**Figure 9**

**SUPPLY CURRENT**  
**(BOTH DRIVERS)**  
**vs**  
**SUPPLY VOLTAGE**

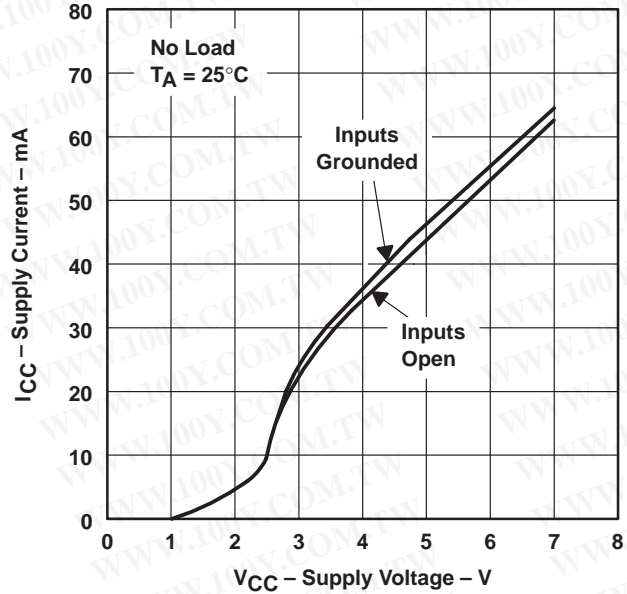

**Figure 10**

**SUPPLY CURRENT**  
**(BOTH DRIVERS)**  
**vs**  
**FREE-AIR TEMPERATURE**

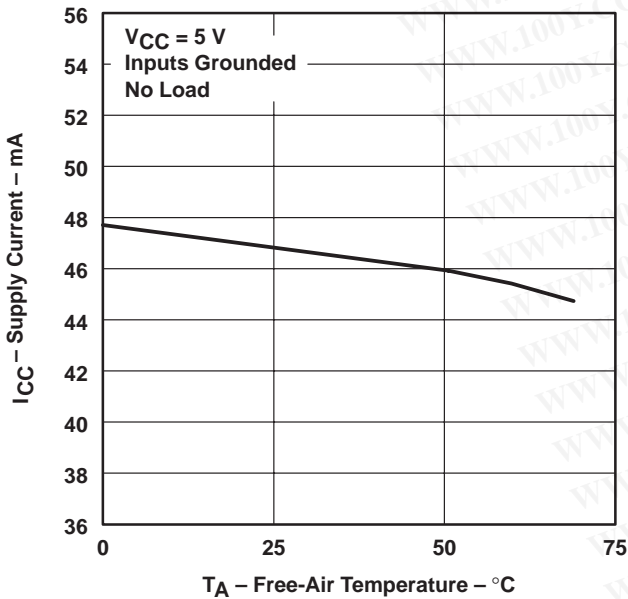

**Figure 11**

**SUPPLY CURRENT**  
**(BOTH DRIVERS)**  
**vs**  
**FREQUENCY**

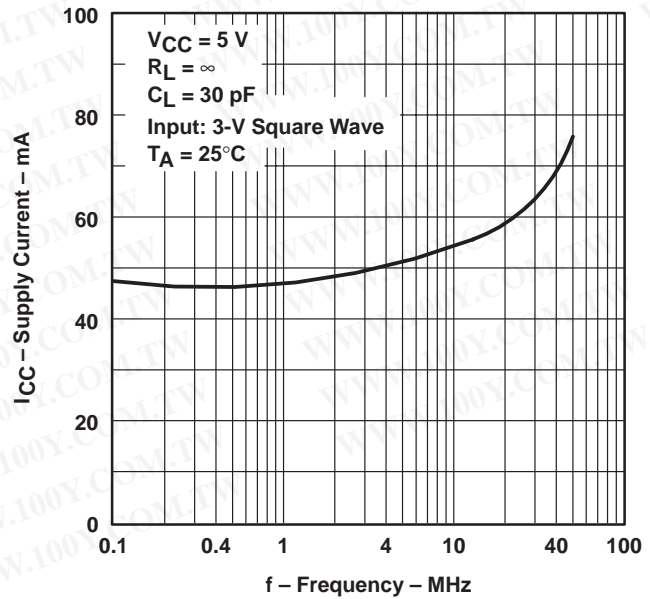

**Figure 12**



TYPICAL CHARACTERISTICS

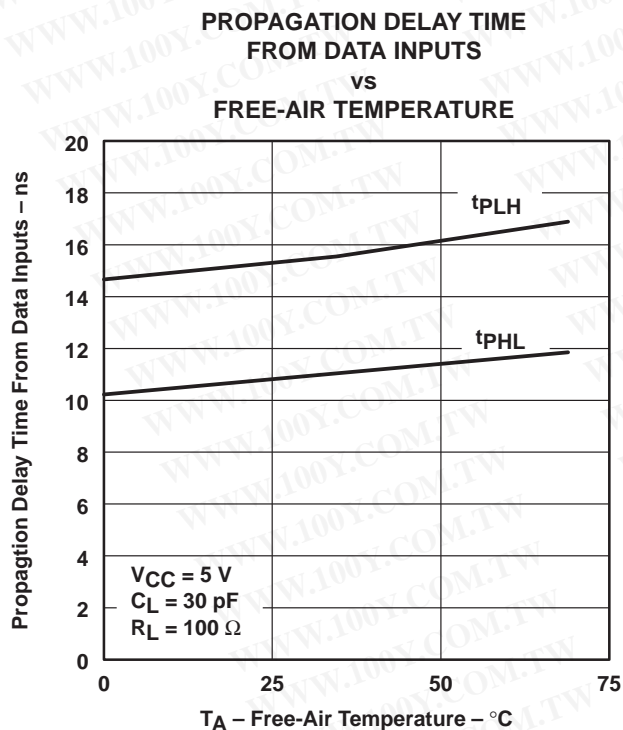

Figure 13

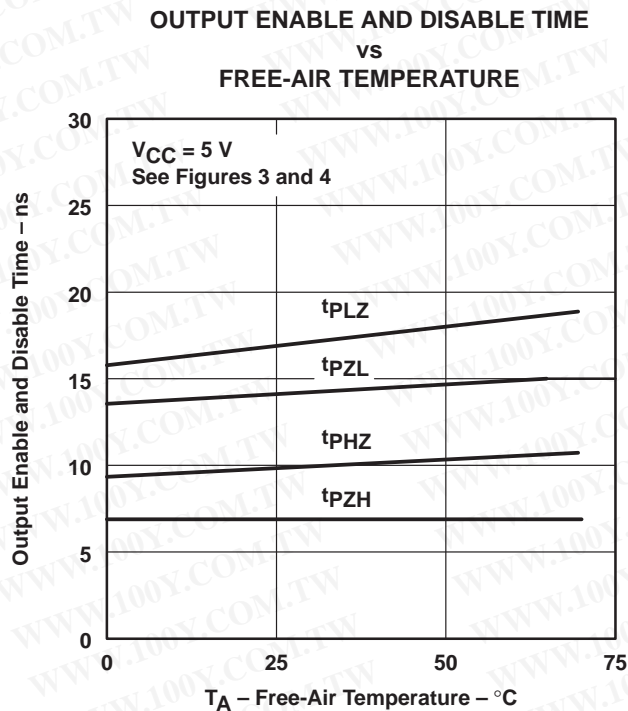

Figure 14

勝特力材料 886-3-5753170  
勝特力电子(上海) 86-21-54151736  
勝特力电子(深圳) 86-755-83298787  
[Http://www.100y.com.tw](http://www.100y.com.tw)

#### IMPORTANT NOTICE

Texas Instruments and its subsidiaries (TI) reserve the right to make changes to their products or to discontinue any product or service without notice, and advise customers to obtain the latest version of relevant information to verify, before placing orders, that information being relied on is current and complete. All products are sold subject to the terms and conditions of sale supplied at the time of order acknowledgement, including those pertaining to warranty, patent infringement, and limitation of liability.

TI warrants performance of its semiconductor products to the specifications applicable at the time of sale in accordance with TI's standard warranty. Testing and other quality control techniques are utilized to the extent TI deems necessary to support this warranty. Specific testing of all parameters of each device is not necessarily performed, except those mandated by government requirements.

CERTAIN APPLICATIONS USING SEMICONDUCTOR PRODUCTS MAY INVOLVE POTENTIAL RISKS OF DEATH, PERSONAL INJURY, OR SEVERE PROPERTY OR ENVIRONMENTAL DAMAGE ("CRITICAL APPLICATIONS"). TI SEMICONDUCTOR PRODUCTS ARE NOT DESIGNED, AUTHORIZED, OR WARRANTED TO BE SUITABLE FOR USE IN LIFE-SUPPORT DEVICES OR SYSTEMS OR OTHER CRITICAL APPLICATIONS. INCLUSION OF TI PRODUCTS IN SUCH APPLICATIONS IS UNDERSTOOD TO BE FULLY AT THE CUSTOMER'S RISK.

In order to minimize risks associated with the customer's applications, adequate design and operating safeguards must be provided by the customer to minimize inherent or procedural hazards.

TI assumes no liability for applications assistance or customer product design. TI does not warrant or represent that any license, either express or implied, is granted under any patent right, copyright, mask work right, or other intellectual property right of TI covering or relating to any combination, machine, or process in which such semiconductor products or services might be or are used. TI's publication of information regarding any third party's products or services does not constitute TI's approval, warranty or endorsement thereof.

Copyright © 1998, Texas Instruments Incorporated