

SN75158 DUAL DIFFERENTIAL LINE DRIVER

SLLS085B – JANUARY 1977 – REVISED MAY 1995

- Meets or Exceeds the Requirements of ANSI EIA/TIA-422-B and ITU Recommendation V.11
- Single 5-V Supply
- Balanced-Line Operation
- TTL Compatible
- High Output Impedance in Power-Off Condition
- High-Current Active-Pullup Outputs
- Short-Circuit Protection
- Dual Channels
- Input Clamp Diodes

D, P, OR PS† PACKAGE
(TOP VIEW)

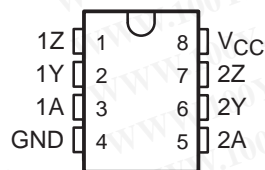

† The PS package is only available left-end taped and reeled, i.e., order SN75158PSLE.

勝特力材料 886-3-5753170
 勝特力电子(上海) 86-21-54151736
 勝特力电子(深圳) 86-755-83298787
 Http://www.100y.com.tw

description

The SN75158 is a dual differential line driver designed to satisfy the requirements set by the ANSI EIA/TIA-422-B and ITU V.11 interface specifications. The outputs provide complementary signals with high-current capability for driving balanced lines, such as twisted pair, at normal line impedance without high power dissipation. The output stages are TTL totem-pole outputs providing a high-impedance state in the power-off condition.

The SN75158 is characterized for operation from 0°C to 70°C.

logic symbol‡

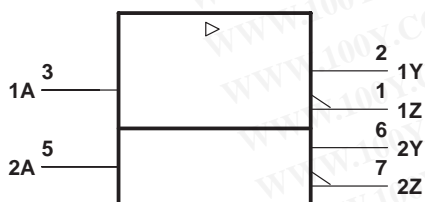

‡ This symbol is in accordance with ANSI/IEEE Std 91-1984 and IEC Publication 617-12.

logic diagram (positive logic)

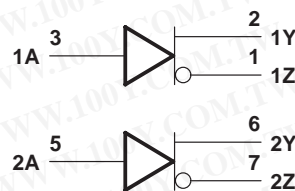

Please be aware that an important notice concerning availability, standard warranty, and use in critical applications of Texas Instruments semiconductor products and disclaimers thereto appears at the end of this data sheet.

PRODUCTION DATA information is current as of publication date. Products conform to specifications per the terms of Texas Instruments standard warranty. Production processing does not necessarily include testing of all parameters.

**TEXAS
INSTRUMENTS**

POST OFFICE BOX 655303 • DALLAS, TEXAS 75265

Copyright © 1995, Texas Instruments Incorporated

SN75158 DUAL DIFFERENTIAL LINE DRIVER

SLLS085B – JANUARY 1977 – REVISED MAY 1995

勝特力材料 886-3-5753170
 勝特力电子(上海) 86-21-54151736
 勝特力电子(深圳) 86-755-83298787
[Http://www.100y.com.tw](http://www.100y.com.tw)

schematics of inputs and outputs

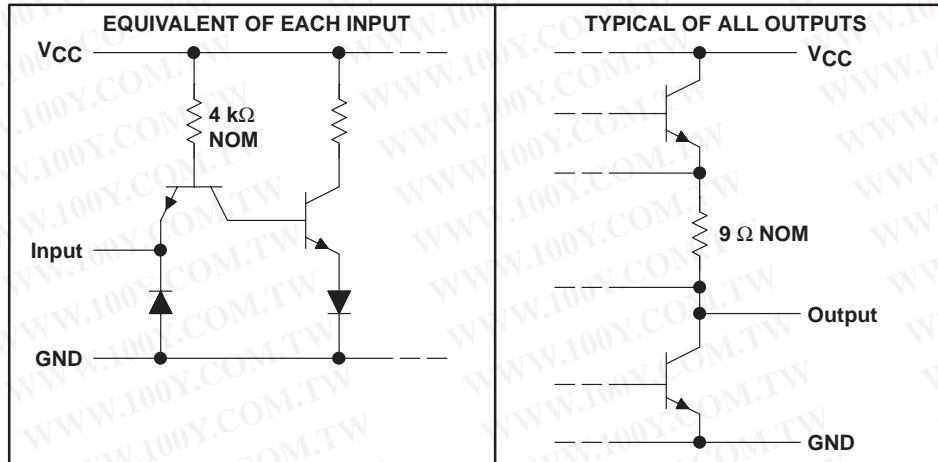

absolute maximum ratings over operating free-air temperature range (unless otherwise noted)†

Supply voltage, V_{CC} (see Note 1)	7 V
Input voltage, V_I	5.5 V
Continuous total power dissipation	See Dissipation Rating Table
Operating free-air temperature range, T_A	0°C to 70°C
Storage temperature range, T_{stg}	-65°C to 150°C
Lead temperature 1,6 mm (1/16 inch) from case for 10 seconds	260°C

† Stresses beyond those listed under “absolute maximum ratings” may cause permanent damage to the device. These are stress ratings only, and functional operation of the device at these or any other conditions beyond those indicated under “recommended operating conditions” is not implied. Exposure to absolute-maximum-rated conditions for extended periods may affect device reliability.

NOTE 1: All voltage values, except differential output voltage V_{OD} , are with respect to network ground terminal. V_{OD} is at the Y output with respect to the Z output.

DISSIPATION RATING TABLE

PACKAGE	$T_A \leq 25^\circ\text{C}$ POWER RATING	DERATING FACTOR ABOVE $T_A = 25^\circ\text{C}$	$T_A = 70^\circ\text{C}$ POWER RATING
D	725 mW	5.8 mW/°C	464 mW
P	1000 mW	8.0 mW/°C	640 mW
PS	450 mW	3.6 mW/°C	288 mW

recommended operating conditions

	MIN	NOM	MAX	UNIT
Supply voltage, V_{CC}	4.75	5	5.25	V
High-level input voltage, V_{IH}	2			V
Low-level input voltage, V_{IL}			0.8	V
High-level output current, I_{OH}			-40	mA
Low-level output current, I_{OL}			40	mA
Operating free-air temperature, T_A	0		70	°C



electrical characteristics over operating free-air temperature range (unless otherwise noted)

PARAMETER		TEST CONDITIONS†	MIN	TYP‡	MAX	UNIT
V_{IK}	Input clamp voltage	$V_{CC} = \text{MIN}$, $I_I = -12 \text{ mA}$		-0.9	-1.5	V
V_{OH}	High-level output voltage	$V_{CC} = \text{MIN}$, $V_{IL} = 0.8 \text{ V}$, $V_{IH} = 2 \text{ V}$, $I_{OH} = -40 \text{ mA}$	2.4	3		V
V_{OL}	Low-level output voltage	$V_{CC} = \text{MIN}$, $V_{IL} = 0.8 \text{ V}$, $V_{IH} = 2 \text{ V}$, $I_{OL} = 40 \text{ mA}$		0.2	0.4	V
$ V_{OD1} $	Differential output voltage	$V_{CC} = \text{MAX}$, $I_O = 0$		3.5	$2 \times V_{OD2}$	V
$ V_{OD2} $	Differential output voltage	$V_{CC} = \text{MIN}$	2	3		V
ΔV_{OD}	Change in magnitude of differential output voltage§	$V_{CC} = \text{MIN}$		± 0.02	± 0.4	V
V_{OC}	Common-mode output voltage¶	$V_{CC} = \text{MAX}$		1.8	3	V
		$V_{CC} = \text{MIN}$		1.5	3	
ΔV_{OC}	Change in magnitude of common-mode output voltage§	$V_{CC} = \text{MIN}$ or MAX		± 0.02	± 0.4	V
I_O	Output current with power off	$V_{CC} = 0$	$V_O = 6 \text{ V}$	0.1	100	μA
			$V_O = -0.25 \text{ V}$	-0.1	-100	
			$V_O = -0.25 \text{ to } 6 \text{ V}$		± 100	
I_I	Input current at maximum input voltage	$V_{CC} = \text{MAX}$, $V_I = 5.5 \text{ V}$			1	mA
I_{IH}	High-level input current	$V_{CC} = \text{MAX}$, $V_I = 2.4 \text{ V}$			40	μA
I_{IL}	Low-level input current	$V_{CC} = \text{MAX}$, $V_I = 0.4 \text{ V}$		-1	-1.6	mA
I_{OS}	Short-circuit output current#	$V_{CC} = \text{MAX}$	-40	-90	-150	mA
I_{CC}	Supply current (both drivers)	$V_{CC} = \text{MAX}$, Inputs grounded, $T_A = 25^\circ\text{C}$, No load		37	50	mA

† For conditions shown as MIN or MAX, use the appropriate value specified under recommended operating conditions.

‡ All typical values are at $V_{CC} = 5 \text{ V}$ and $T_A = 25^\circ\text{C}$ except for V_{OC} , for which V_{CC} is as stated under test conditions.

§ ΔV_{OD} and $\Delta|V_{OC}|$ are the changes in magnitudes of V_{OD} and V_{OC} , respectively, that occur when the input is changed from a high level to a low level.

¶ In ANSI Standard EIA/TIA-422-B, V_{OC} , which is the average of the two output voltages with respect to ground, is called output offset voltage, V_{OS} .

Only one output should be shorted at a time, and duration of the short circuit should not exceed one second.

switching characteristics, $V_{CC} = 5 \text{ V}$, $T_A = 25^\circ\text{C}$

PARAMETER		TEST CONDITIONS	MIN	TYP	MAX	UNIT
t_{PLH}	Propagation delay time, low-to-high-level output	See Figure 2, Termination A		16	25	ns
t_{PHL}	Propagation delay time, high-to-low-level output			10	20	ns
t_{PLH}	Propagation delay time, low-to-high-level output	See Figure 2, Termination B		13	20	ns
t_{PHL}	Propagation delay time, high-to-low-level output			9	15	ns
t_{TLH}	Transition time, low-to-high-level output	See Figure 2, Termination A		4	20	ns
t_{TLH}	Transition time, high-to-low-level output			4	20	ns
Overshoot factor		See Figure 2, Termination C			10%	

SN75158 DUAL DIFFERENTIAL LINE DRIVER

SLLS085B – JANUARY 1977 – REVISED MAY 1995

PARAMETER MEASUREMENT INFORMATION

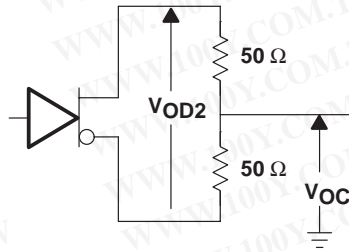

勝特力材料 886-3-5753170
 勝特力电子(上海) 86-21-54151736
 勝特力电子(深圳) 86-755-83298787
[Http://www.100y.com.tw](http://www.100y.com.tw)

Figure 1. Differential and Common-Mode Output Voltages

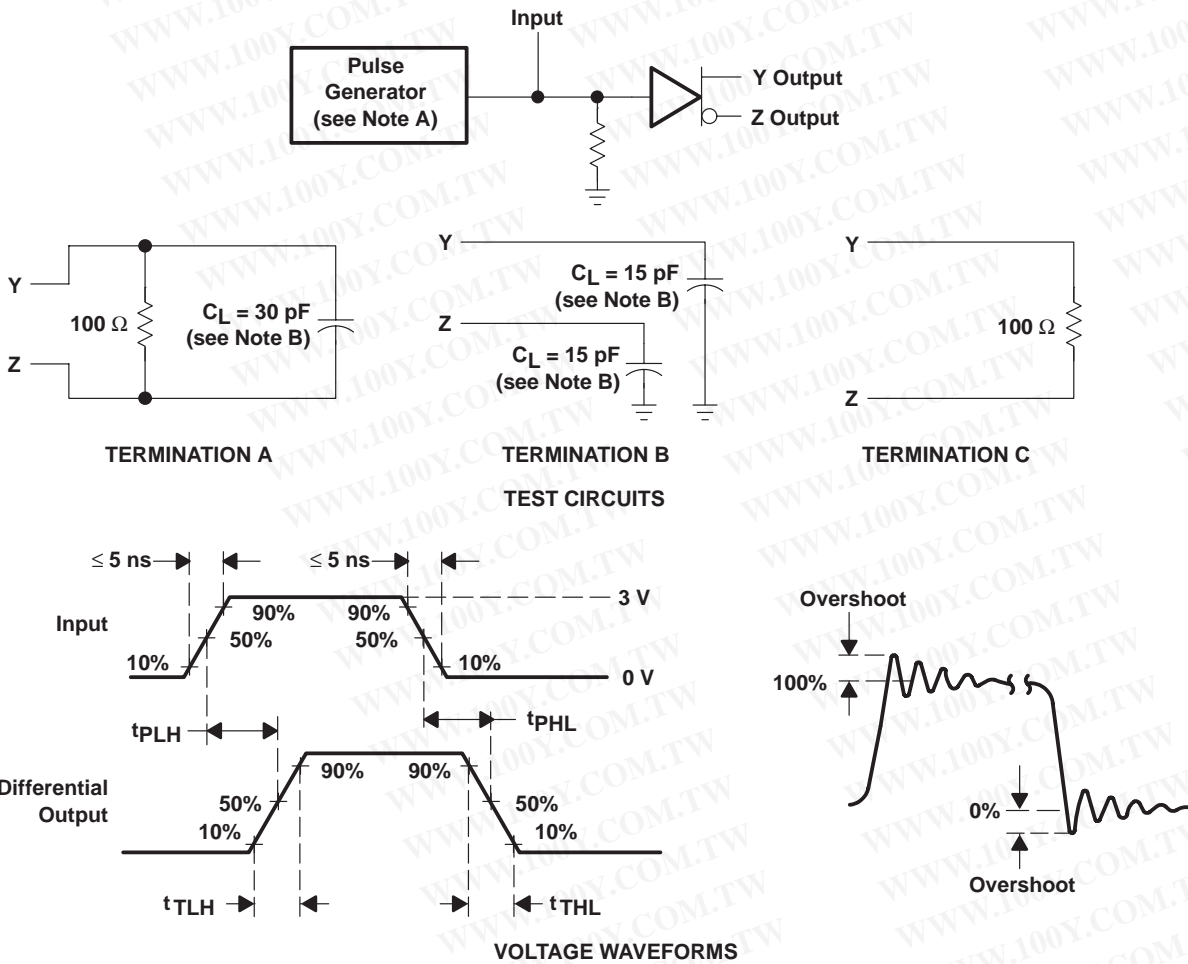

NOTES: A. The pulse generator has the following characteristics: $Z_O = 50 \Omega$, $t_w = 25 \text{ ns}$, $\text{PRR} \leq 10 \text{ MHz}$.
 B. C_L includes probe and jig capacitance.

Figure 2. Test Circuit and Voltage Waveforms

TYPICAL CHARACTERISTICS

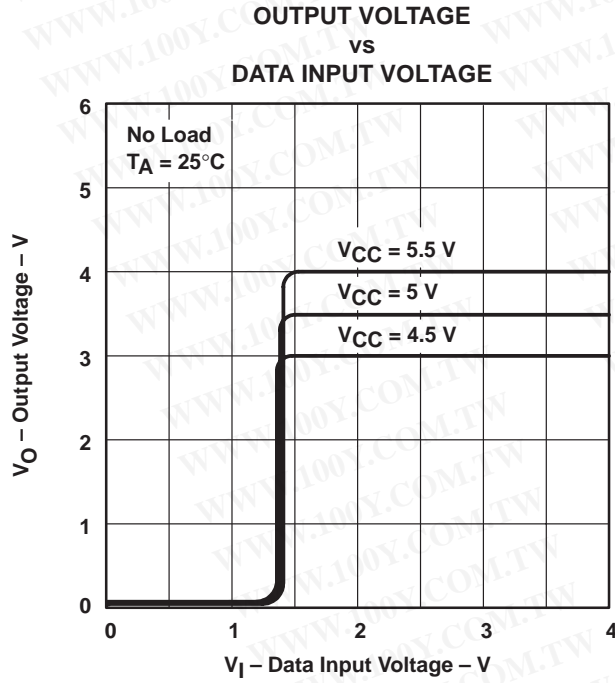

Figure 3

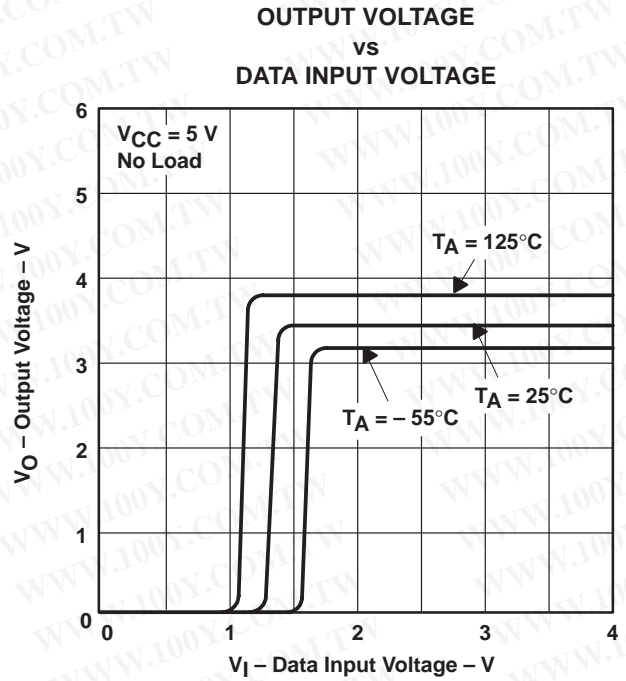

Figure 4

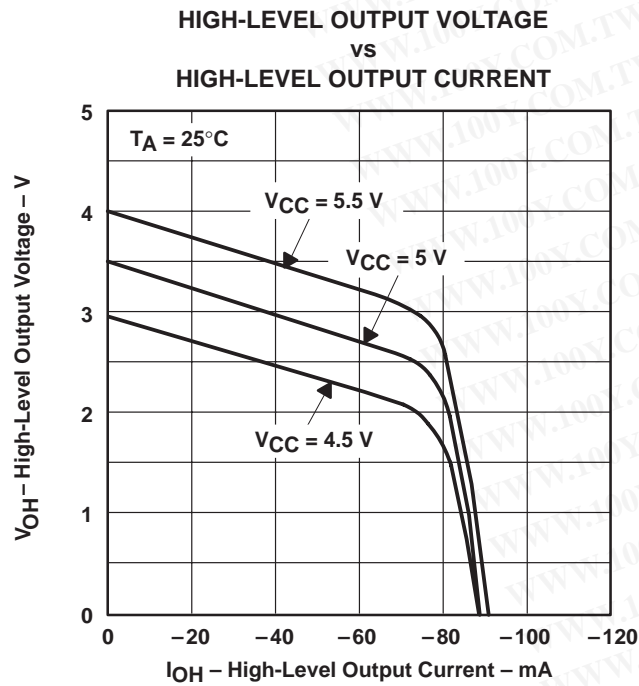

Figure 5

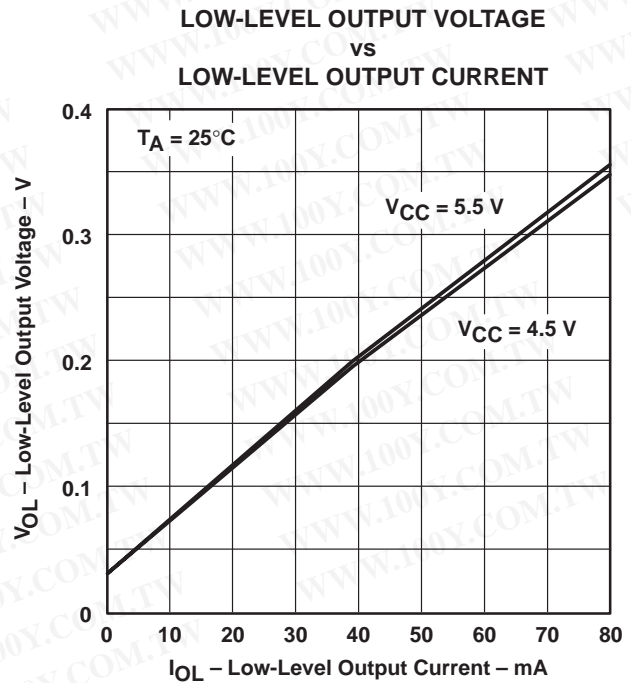

Figure 6

TYPICAL CHARACTERISTICS

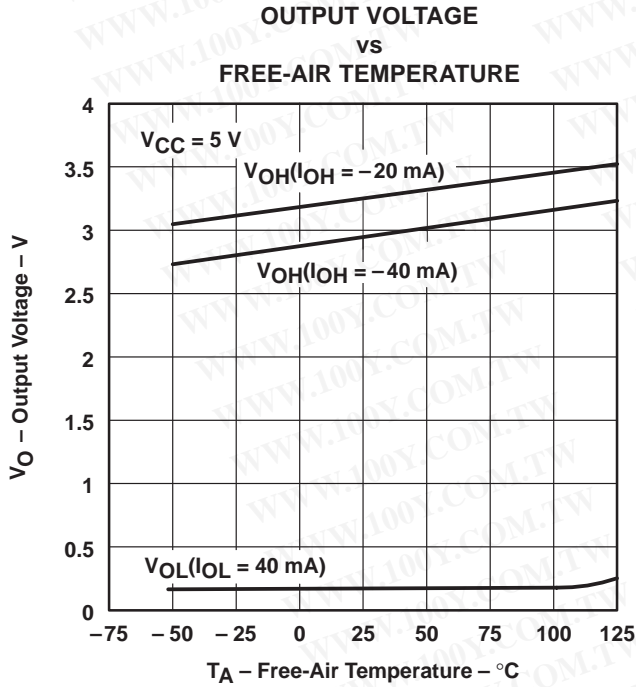

Figure 7

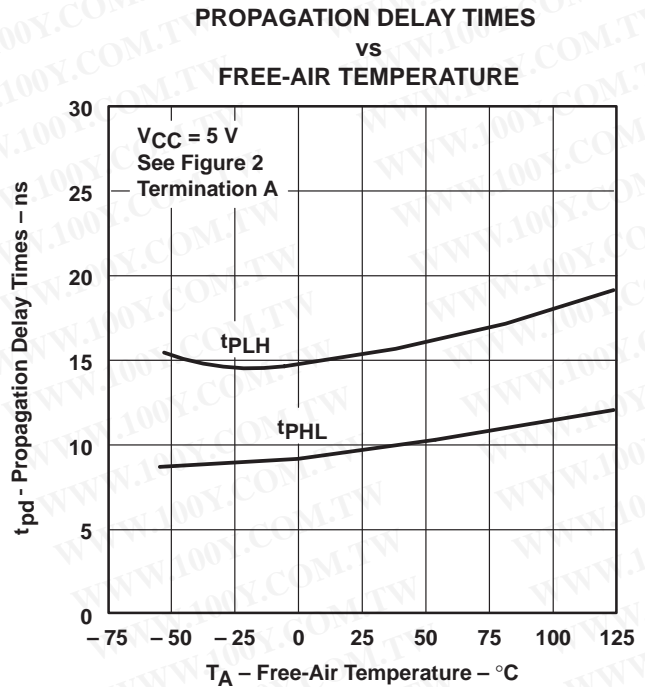

Figure 8

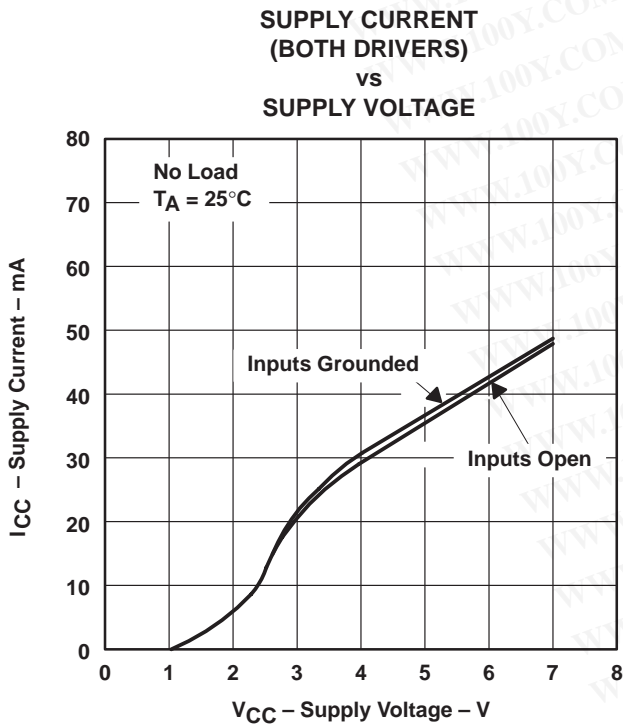

Figure 9

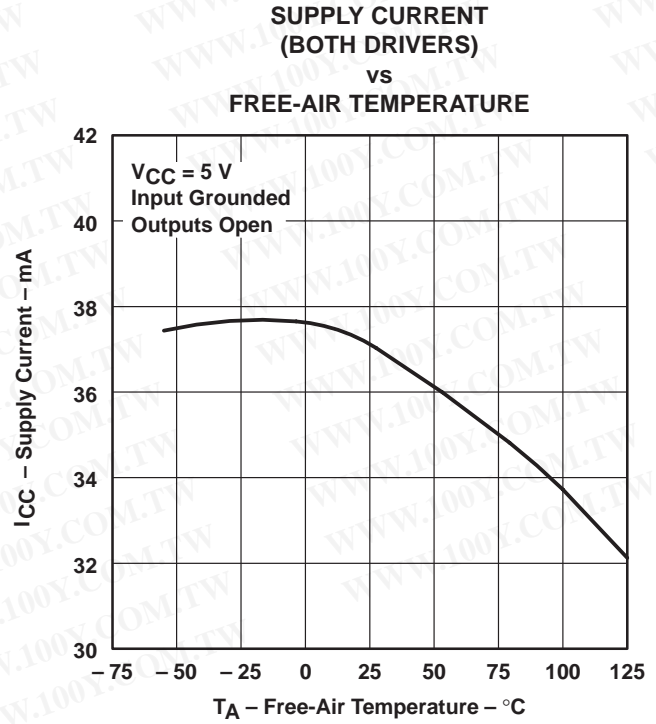

Figure 10

TYPICAL CHARACTERISTICS

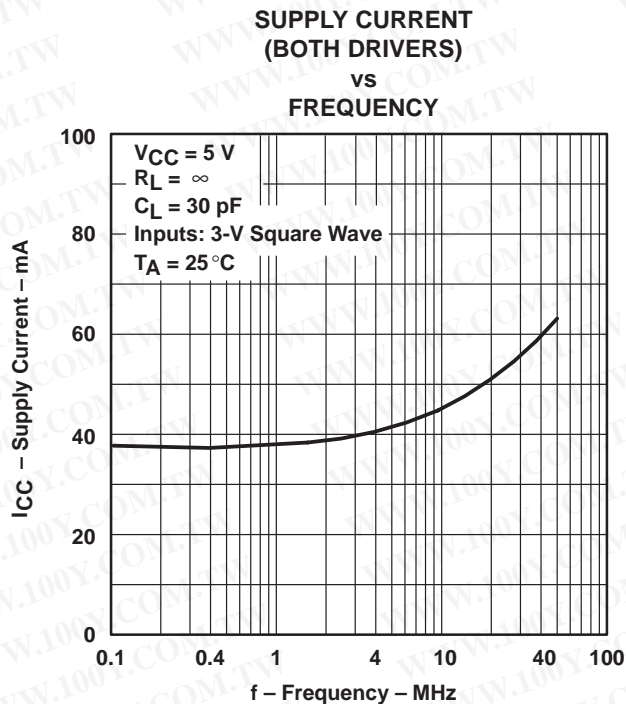

Figure 11

勝特力材料 886-3-5753170
勝特力电子(上海) 86-21-54151736
勝特力电子(深圳) 86-755-83298787
[Http://www.100y.com.tw](http://www.100y.com.tw)

勝特力材料 886-3-5753170
勝特力电子(上海) 86-21-54151736
勝特力电子(深圳) 86-755-83298787
[Http://www.100y.com.tw](http://www.100y.com.tw)

IMPORTANT NOTICE

Texas Instruments and its subsidiaries (TI) reserve the right to make changes to their products or to discontinue any product or service without notice, and advise customers to obtain the latest version of relevant information to verify, before placing orders, that information being relied on is current and complete. All products are sold subject to the terms and conditions of sale supplied at the time of order acknowledgement, including those pertaining to warranty, patent infringement, and limitation of liability.

TI warrants performance of its semiconductor products to the specifications applicable at the time of sale in accordance with TI's standard warranty. Testing and other quality control techniques are utilized to the extent TI deems necessary to support this warranty. Specific testing of all parameters of each device is not necessarily performed, except those mandated by government requirements.

CERTAIN APPLICATIONS USING SEMICONDUCTOR PRODUCTS MAY INVOLVE POTENTIAL RISKS OF DEATH, PERSONAL INJURY, OR SEVERE PROPERTY OR ENVIRONMENTAL DAMAGE ("CRITICAL APPLICATIONS"). TI SEMICONDUCTOR PRODUCTS ARE NOT DESIGNED, AUTHORIZED, OR WARRANTED TO BE SUITABLE FOR USE IN LIFE-SUPPORT DEVICES OR SYSTEMS OR OTHER CRITICAL APPLICATIONS. INCLUSION OF TI PRODUCTS IN SUCH APPLICATIONS IS UNDERSTOOD TO BE FULLY AT THE CUSTOMER'S RISK.

In order to minimize risks associated with the customer's applications, adequate design and operating safeguards must be provided by the customer to minimize inherent or procedural hazards.

TI assumes no liability for applications assistance or customer product design. TI does not warrant or represent that any license, either express or implied, is granted under any patent right, copyright, mask work right, or other intellectual property right of TI covering or relating to any combination, machine, or process in which such semiconductor products or services might be or are used. TI's publication of information regarding any third party's products or services does not constitute TI's approval, warranty or endorsement thereof.

Copyright © 1998, Texas Instruments Incorporated