

勝特力材料 886-3-5753170
 勝特力电子(上海) 86-21-54151736
 勝特力电子(深圳) 86-755-83298787
[Http://www.100y.com.tw](http://www.100y.com.tw)

R13-541

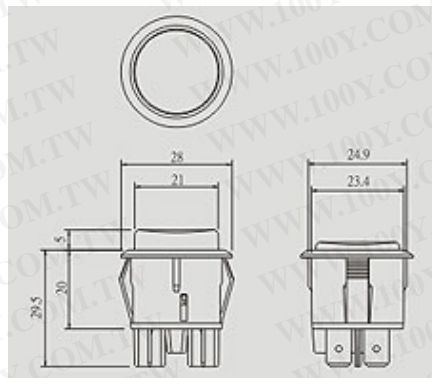

Rating

16A 250V AC
 1HP 250V AC
 1/2HP 125V AC

Contact resistance

50mΩ Max

Insulation resistance

DC 500V 100MΩ
 Min

Dielectric strength

AC 1000V 1 minute

Cut-out







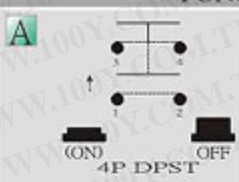
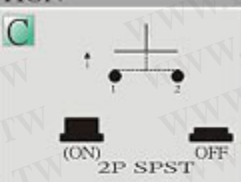

0.7~5 mm max

FEATURES

- MATERIAL: Frames are nylon with glass fiber (UL flame: 94V-2). Terminals are silver plated brass.
- Illuminated actuators are molded in PC, available with red, amber, and green colors.
- Snap-in mounting, easy to install switch into panel.

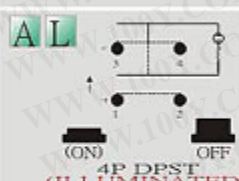
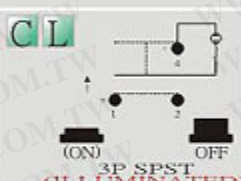
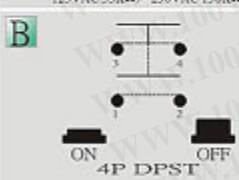
R13-541   -  

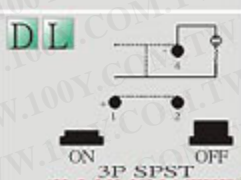
FUNCTION		TERMINAL
A  4P DPST (ON) OFF	C  2P SPST (ON) OFF	   .250" SQ
AL  4P DPST (ILLUMINATED) 125VAC 33KΩ / 250VAC 150KΩ	CL  3P SPST (ILLUMINATED) 125VAC 33KΩ / 250VAC 150KΩ	
B  4P DPST ON OFF	D  2P SPST OFF ON	
BL  4P DPST (ILLUMINATED) 125VAC 33KΩ / 250VAC 150KΩ	DL  3P SPST (ILLUMINATED) 125VAC 33KΩ / 250VAC 150KΩ	