

PROMOVER PRODUCTS

Shape

HPE-3093/3095

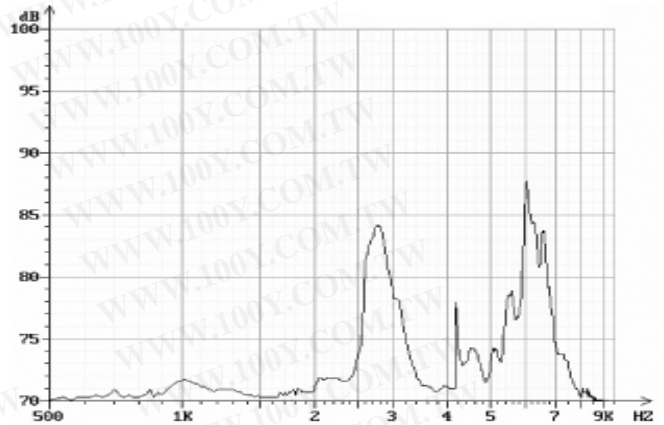

Model Number	HPE-3093	HPE-3095
Rated Voltage(Vp-p)	3.0	5.0
Operating Voltage(Vp-p)	2.0-4.0	4.0-6.0
Current Consumption Max(mA)	100	70
Coil Resistance(Ω)	15±2	32±2
SPL Min. (dB) at 10cm	82	
Resonant Frequency(Hz)	2730	
Operating Temperature(°C)	-20~+70	
Storage Temperature(°C)	-30~+80	
Tone	Continuous Sound	
Material	PPO	

Dimension

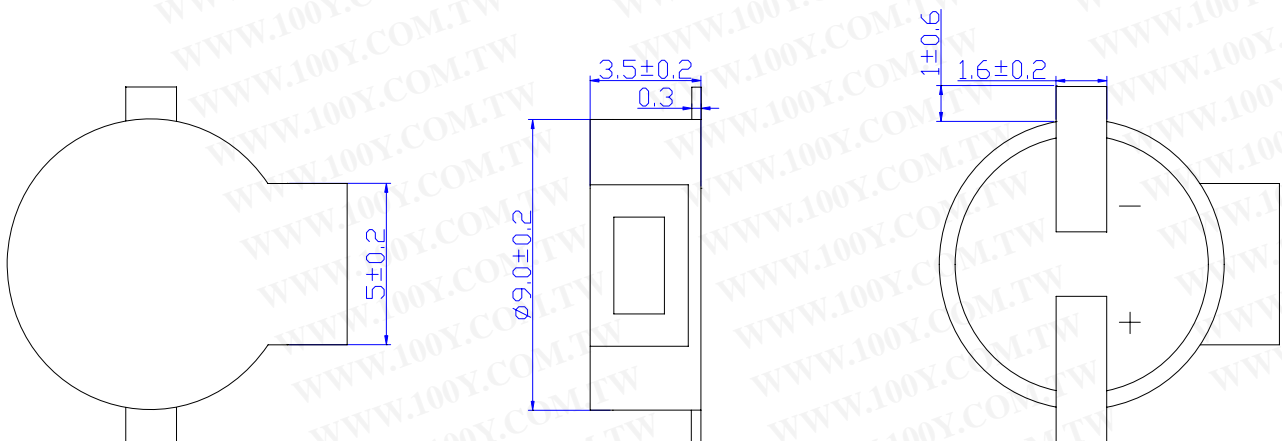

勝特力材料 886-3-5753170
 勝特力电子(上海) 86-21-54151736
 勝特力电子(深圳) 86-755-83298787
[Http://www.100y.com.tw](http://www.100y.com.tw)

Tolerance:±0.5 Unit:mm