

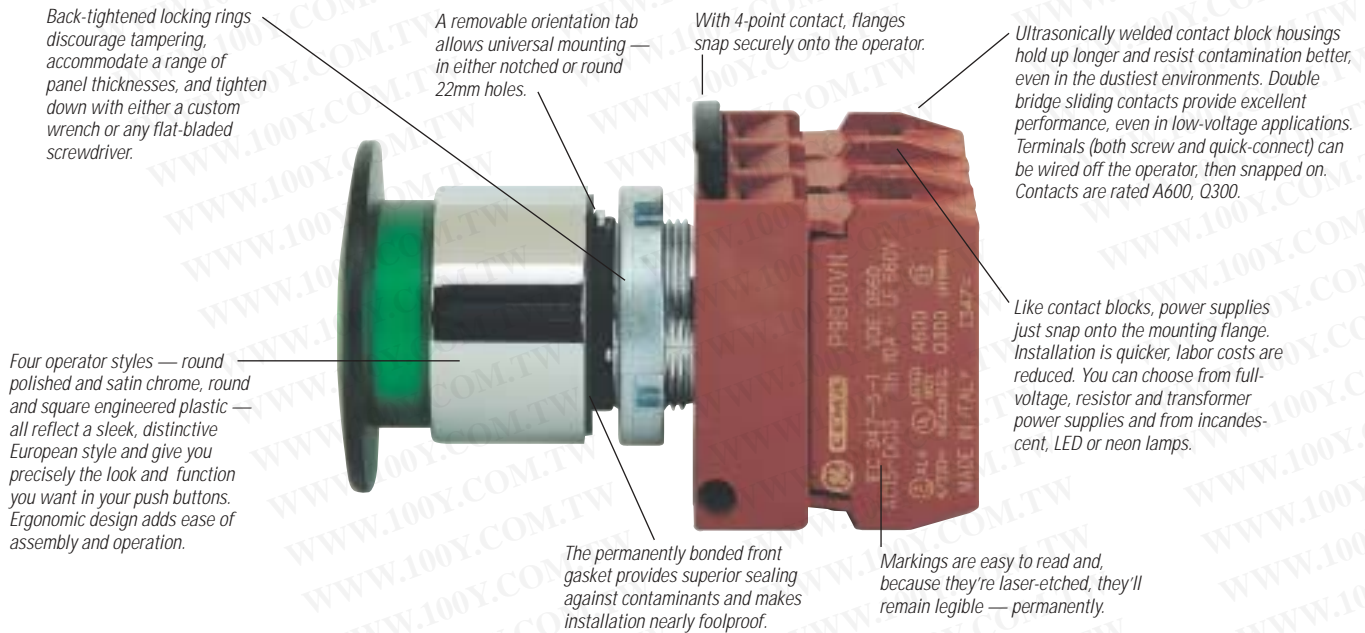

勝特力材料 886-3-5753170
 勝特力电子(上海) 86-21-54151736
 勝特力电子(深圳) 86-755-83298787
[Http://www.100y.com.tw](http://www.100y.com.tw)

C-2000™ Push Buttons

C-2000 Push Buttons Reveal The Beauty Of Simplicity In Every Detail



C-2000 push buttons bring the beauty of simplicity to heavy-duty 22mm push buttons. You'll see it in their outstanding appearance, thoughtful ergonomics, expansive selection, innovative contact blocks, modular versatility, long-term reliability, and global applicability.



Outstanding appearance and ergonomics.

The beauty of C-2000 push buttons adds class to any panel. But their distinctive European styling also incorporates ergonomic design features that provide a sure, easy touch for the people who use them.



Huge selection. With four operator styles, a vast array of operator types, a complete selection of contact blocks and power supplies, your choice of nameplates and enclosures, lamps for every need, and a multitude of useful accessories, you'll find in C-2000 push buttons exactly what you're looking for.

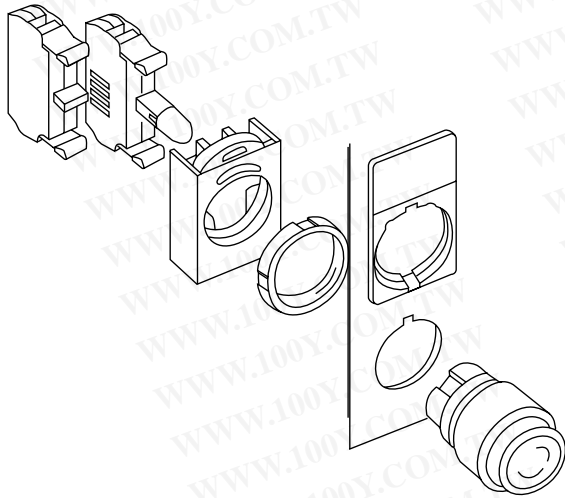

True modularity, real simplicity. Because all operators, flanges, contact blocks and power supplies simply snap together, installation is fast, inventory requirements are slashed, and application flexibility is greatly increased. You can wire terminals off the operator, then snap the block on when you're done. Disassembly is just as easy.



Innovative contact blocks. Unique, patented double bridge wiping contacts in ultrasonically welded housings provide long life and superior contact fidelity, even in low voltage applications.

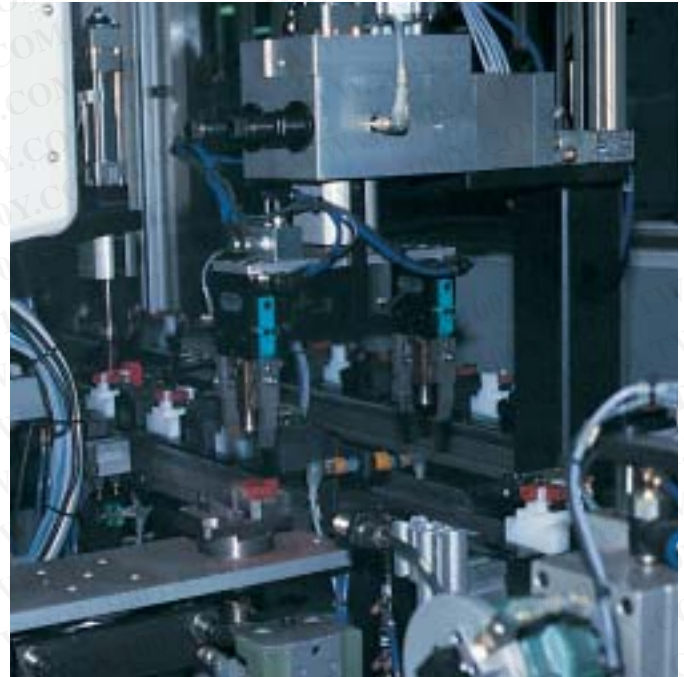

Designed and built for reliability. Quality is built in to every component using advanced design and manufacturing technologies. 100% on-line inspection assures you of the reliability you need.

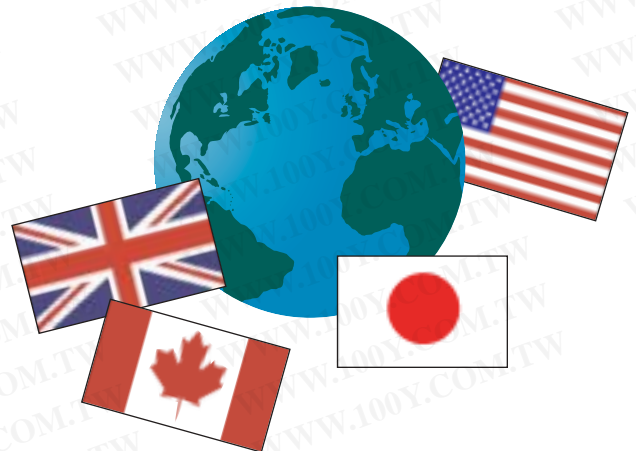

World-wide approval and availability. C-2000 push buttons are truly global. Around the world their catalog numbers follow the same logical nomenclature that simplifies identification and specification. Around the world, they're readily available. Around the world, they meet the standards.



How To Select, Price And Order C-2000 Push Buttons

This catalog contains virtually all of the information you'll need to understand, evaluate, select, price, and apply C-2000 push buttons. Please note, however, that prices and data are subject to change without notice.

Technical data, on pages 6-11, provides complete specifications, terminal and contact data, mechanical and electrical life ratings, materials, power supply information, maximum contacts by operator and lamp selection tips. Guideform specifications appear on page 11.

A guide to C-2000 push button nomenclature (pages 12-14) offers insight into this logical catalog numbering system. This will be helpful in understanding how the nomenclature works, and useful in deciphering particular catalog numbers, but should not be used to develop a specific catalog number, as not all possible combinations of catalog number digits produce available devices. To find a catalog number for a specific product, use the data beginning on page 15.

To select modular components, see pages 15-48. You'll find ordering modular components — as well as assembling and stocking them — fast and easy. **To select assembled devices**, see pages 49-53. Assembled devices provide a single catalog number for complete devices (which is a handy reference in certain circumstances, even if you order modular components). To develop a catalog number and list price for assembled components, just follow the step-by-step process explained in that section. Note that there is a \$5.00 (List Price, GO-10GC) assembly surcharge for assembled devices.

Many assembled devices are available from GE Industrial Systems stock. In the case that a required device is not available, **the components to assemble it will generally be stocked**. A third alternative may be to choose a similar assembled device and the required parts to modify it. In either case GE is bound to have what is needed.

To order, contact your GE Industrial Systems distributor or your nearest sales office.

勝特力材料 886-3-5753170
勝特力电子(上海) 86-21-54151736
勝特力电子(深圳) 86-755-83298787
[Http://www.100y.com.tw](http://www.100y.com.tw)

The selection process is mapped out at the beginning of each operator section, directing you in the steps necessary to specify a single device. Color coding speeds and simplifies the location of data for each step.

Illuminated Push Buttons

Selection Process

Select operator below → Select power supply from back cover fold-out → Select contact block from back cover fold-out → Select nameplate, if required, from pages 36-38 → Complete unit

Operators

Style	Extended Catalog No.	List Price, GO-16CC	Flash Catalog No.	Recessed Catalog No.	List Price, GO-16CC
Standard Operator	PP04*SD	11.50	PP04*GD	PP04*TD	11.50
Round Operator	PP04*RD	10.50	PP04*RD	PP04*TD	11.50
Round Engineered Plastic	PP04*ED	10.50	PP04*GD	PP04*TD	11.50
Square Engineered Plastic	PP04*SD	10.50	PP04*GD	PP04*TD	11.50

Colors

Color	Red	Green	Yellow	Blue	White	Orange	Clear	No Lens
Color Code	R	V	G	L	B	A	I	0

* Values ordering illuminated push buttons with no lens, change eighth digit in catalog number from 0 to 9 and deduct \$1.00 from list price.

Selection & drawing data: pages 4-5. Accessories: pages 46-47. Technical data: pages 8-11. Specialty Color Caps, holes, lenses and handles are also sketched separately: page 81.

Product pages contain all necessary data for selecting operators or accessories

Contact block and power supply selection data are featured on the back cover foldout. By opening this foldout as you select operators, you'll be able to easily choose corresponding contact blocks and power supplies for your complete unit.

Select operators based on style and type. Make any catalog number digits substitutions required (e.g., for colors or keys) using accompanying options tables. List prices appear to the right of your selected catalog number.

Outline drawings for all listed devices appear on each product page or, in some circumstances, on adjacent pages.

Page references make location of associated information easy.

Power Supplies & Contact Blocks

Power Supplies

Type	Power Supply	Voltage	Incandescent		LED		Neon ¹	
			Catalog Number	List Price, GO-16CC	Catalog Number	List Price, GO-16CC	Catalog Number	List Price, GO-16CC
Screw Terminal	No Lamp	24	PP04V04	11.50	PP04V04	3.00	---	---
			PP04V08	21.00	PP04V08	35.00	---	---
			PP04V12	21.00	PP04V12	35.00	---	---
			PP04V16	21.00	PP04V16	35.00	---	---
			PP04V20	21.00	---	---	---	---
			PP04V24	21.00	---	---	---	---
			PP04V28	21.00	---	---	---	---
			PP04V32	21.00	---	---	---	---
			PP04V36	21.00	---	---	---	---
			PP04V40	21.00	---	---	---	---
			PP04V44	21.00	---	---	---	---
			PP04V48	21.00	---	---	---	---
Screw Terminal, Floating	No Lamp	24	PP04F04	11.50	PP04F04	3.00	---	---
			PP04F08	21.00	PP04F08	35.00	---	---
			PP04F12	21.00	PP04F12	35.00	---	---
			PP04F16	21.00	PP04F16	35.00	---	---
			PP04F20	21.00	---	---	---	---
			PP04F24	21.00	---	---	---	---
			PP04F28	21.00	---	---	---	---
			PP04F32	21.00	---	---	---	---
			PP04F36	21.00	---	---	---	---
			PP04F40	21.00	---	---	---	---
			PP04F44	21.00	---	---	---	---
			PP04F48	21.00	---	---	---	---
Screw Terminal, Panel Fit	No Lamp	24	PP04P04	11.50	PP04P04	3.00	---	---
			PP04P08	21.00	PP04P08	35.00	---	---
			PP04P12	21.00	PP04P12	35.00	---	---
			PP04P16	21.00	PP04P16	35.00	---	---
			PP04P20	21.00	---	---	---	---
			PP04P24	21.00	---	---	---	---
			PP04P28	21.00	---	---	---	---
			PP04P32	21.00	---	---	---	---
			PP04P36	21.00	---	---	---	---
			PP04P40	21.00	---	---	---	---
			PP04P44	21.00	---	---	---	---
			PP04P48	21.00	---	---	---	---
Duck Connect Terminal	No Lamp	24	PP04D04	11.50	PP04D04	3.00	---	---
			PP04D08	21.00	PP04D08	35.00	---	---
			PP04D12	21.00	PP04D12	35.00	---	---
			PP04D16	21.00	PP04D16	35.00	---	---
			PP04D20	21.00	---	---	---	---
			PP04D24	21.00	---	---	---	---
			PP04D28	21.00	---	---	---	---
			PP04D32	21.00	---	---	---	---
			PP04D36	21.00	---	---	---	---
			PP04D40	21.00	---	---	---	---
			PP04D44	21.00	---	---	---	---
			PP04D48	21.00	---	---	---	---
Transformer, 50/60 Hz, AC	Screw Terminal	24	PP04T04	42.50	PP04T04	57.50	---	---
			PP04T08	42.50	PP04T08	57.50	---	---
			PP04T12	42.50	PP04T12	57.50	---	---
			PP04T16	42.50	PP04T16	57.50	---	---
			PP04T20	42.50	PP04T20	57.50	---	---
			PP04T24	42.50	PP04T24	57.50	---	---
			PP04T28	42.50	PP04T28	57.50	---	---
			PP04T32	42.50	PP04T32	57.50	---	---
			PP04T36	42.50	PP04T36	57.50	---	---
			PP04T40	42.50	PP04T40	57.50	---	---
			PP04T44	42.50	PP04T44	57.50	---	---
			PP04T48	42.50	PP04T48	57.50	---	---
Resistor, AC/DC	Screw Terminal, Standard	24	PP04R04	35.00	---	---	---	---
			PP04R08	35.00	---	---	---	---
			PP04R12	35.00	---	---	---	---
			PP04R16	35.00	---	---	---	---
			PP04R20	35.00	---	---	---	---
			PP04R24	35.00	---	---	---	---
			PP04R28	35.00	---	---	---	---
			PP04R32	35.00	---	---	---	---
			PP04R36	35.00	---	---	---	---
			PP04R40	35.00	---	---	---	---
			PP04R44	35.00	---	---	---	---
			PP04R48	35.00	---	---	---	---

Contact Blocks

Contact Block	Type	Contacts	Catalog Number	List Price, GO-16CC
Screw Terminal	Standard	1NC	PP01TUN	87.50
	1NC/1NO	1NC/1NO	PP01TUN	15.00
	1NC/1NO/1C	1NC/1NO/1C	PP01TUN	7.50
	Base Mount	1NO	PP01TUN	7.50
Screw Terminal, Time Delay	1NC	1NC	PP01TUN	35.00
	1NO	1NO	PP01TUN	35.00
Duck Connect Terminal	Standard	1NC	PP01TUN	7.50
	1NC	1NC	PP01TUN	7.50

LED Colors

LED Color	Red	Green	Yellow	Amber	White
Color Code	R	V	G	A	B

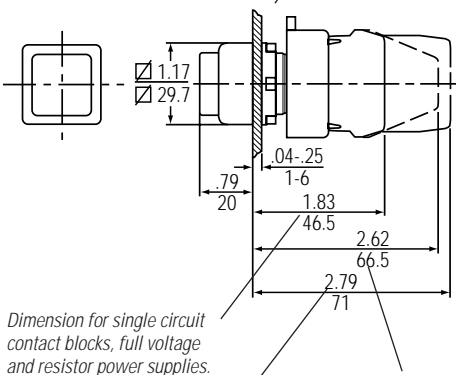

Dimension for single circuit contact blocks, full voltage and resistor power supplies.

Dimension for transformer power supplies.

Dimension for double circuit contact blocks.

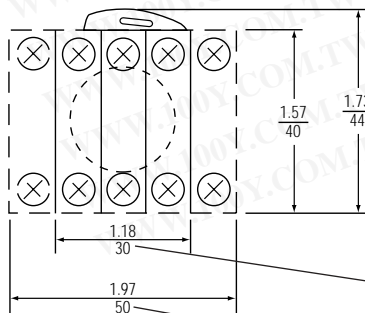

Dimension for 3-position flange (comes standard with all operators).

Dimension for 5-position flange (must be ordered separately, see page 46).



勝特力材料 886-3-5753170
勝特力电子(上海) 86-21-54151736
勝特力电子(深圳) 86-755-83298787
[Http://www.100y.com.tw](http://www.100y.com.tw)

C-2000™ Push Buttons

Technical Data

General Specifications																																																																																											
Conformity to standards	UL 508 (USA) NEMA ICS-2 (USA) VDE 0660 (Germany) BSI (Great Britain) CEI EN60947.5.1 (Italy) CENELEC EN 5000 7 (Europe)																																																																																										
Approvals	CSA C22.2 No. 14-M91 (Canada) IEC 947.5.1 (International) UTE (France) NFC 63140 (France) JIS (Japan)																																																																																										
Finger protection at terminals	UL Listed - File Number E66677 CSA Certified - File Number 16661-63 Manufacturing facility is registered to ISO 9000																																																																																										
Enclosure ratings	IP2X according to IEC 529 Terminal identification per CENELEC EN 50013																																																																																										
Ambient temperature	Suitable for use in NEMA Types 1, 3, 3R, 3S, 4, 4X, 12 and 13 enclosures. (Multi-function push buttons are suitable for NEMA Type 1 enclosures only unless used with protective rubber cap accessory.) IP66 per IEC 529, when mounted in enclosures with equal or superior seal.																																																																																										
Climate suitability/humidity	<table border="1" style="width: 100%; border-collapse: collapse;"> <thead> <tr> <th style="text-align: left;">Climate Type</th> <th style="text-align: left;">Temperature</th> <th style="text-align: left;">Relative Humidity</th> </tr> </thead> <tbody> <tr> <td>Temperate</td> <td>74°F (23° C)</td> <td>50%</td> </tr> <tr> <td>Wet</td> <td>74°F (23° C)</td> <td>83%</td> </tr> <tr> <td>Hot Wet</td> <td>104°F (40° C)</td> <td>92%</td> </tr> <tr> <td>Variable Wet</td> <td>74° to 104° F (23° to 40° C)</td> <td>83% to 92%</td> </tr> </tbody> </table>	Climate Type	Temperature	Relative Humidity	Temperate	74°F (23° C)	50%	Wet	74°F (23° C)	83%	Hot Wet	104°F (40° C)	92%	Variable Wet	74° to 104° F (23° to 40° C)	83% to 92%																																																																											
Climate Type	Temperature	Relative Humidity																																																																																									
Temperate	74°F (23° C)	50%																																																																																									
Wet	74°F (23° C)	83%																																																																																									
Hot Wet	104°F (40° C)	92%																																																																																									
Variable Wet	74° to 104° F (23° to 40° C)	83% to 92%																																																																																									
Resistance to vibration	Per IEC 68-2-6 . 16g with a frequency from 40-500 Hz and maximum peak-to-peak amplitude of 0.75mm.																																																																																										
Resistance to shock	According to MIL 202B, method 202A . Test was performed for 1/2 sinusoid for 11ms, 38g max for all operators with transformers and 100g for all other operators.																																																																																										
Operating force	Standard push button operator: 2.5 lb (11 N) Each contact block: 1.3 lb (6 N) Selector switch operator : 2.4 in-lb (0.27 N-m)																																																																																										
Wire Terminals																																																																																											
Wire capacity and terminal torque requirements (for all power supplies and contact blocks)	Suitable for #22-#12 AWG stranded or solid copper wires, single or parallel conductors of same size. Terminal torque: 7-12 in-lbs. Parallel conductor size combinations (stranded or solid wire): <table border="1" style="width: 100%; border-collapse: collapse; margin-top: 10px;"> <thead> <tr> <th style="text-align: left;">Parallel Conductor Size Combinations (Stranded Or Solid Wire)</th> <th style="text-align: left;">Terminal Torque</th> </tr> </thead> <tbody> <tr><td>#12 with #14</td><td>12 in-lbs</td></tr> <tr><td>#14 with #16</td><td>12 in-lbs</td></tr> <tr><td>#16 with #18</td><td>12 in-lbs</td></tr> <tr><td>#16 with #20</td><td>12 in-lbs</td></tr> <tr><td>#16 with #22</td><td>12 in-lbs</td></tr> <tr><td>#18 with #22</td><td>10-12 in-lbs</td></tr> <tr><td>#18 with #20</td><td>10-12 in-lbs</td></tr> <tr><td>#20 with #22</td><td>7-12 in-lbs</td></tr> </tbody> </table>	Parallel Conductor Size Combinations (Stranded Or Solid Wire)	Terminal Torque	#12 with #14	12 in-lbs	#14 with #16	12 in-lbs	#16 with #18	12 in-lbs	#16 with #20	12 in-lbs	#16 with #22	12 in-lbs	#18 with #22	10-12 in-lbs	#18 with #20	10-12 in-lbs	#20 with #22	7-12 in-lbs																																																																								
Parallel Conductor Size Combinations (Stranded Or Solid Wire)	Terminal Torque																																																																																										
#12 with #14	12 in-lbs																																																																																										
#14 with #16	12 in-lbs																																																																																										
#16 with #18	12 in-lbs																																																																																										
#16 with #20	12 in-lbs																																																																																										
#16 with #22	12 in-lbs																																																																																										
#18 with #22	10-12 in-lbs																																																																																										
#18 with #20	10-12 in-lbs																																																																																										
#20 with #22	7-12 in-lbs																																																																																										
Quick connect terminals	Suitable for one female tab connector measuring 0.25 x 0.03 inches (6.35 x 0.8 mm) or two female tab connectors measuring 0.11 x 0.03 inches (2.8 x 0.8 mm).																																																																																										
Contact Data																																																																																											
Electrical reliability data	Electrical life and reliability in low level current: 80 million operations at 12V, 5mA, resistive load. (32 contacts tested successfully for 2.5 million operations.)																																																																																										
Dust resistance	In extremely dusty environments, electrical life at low level current is 250,000 operations at 12V, 5mA, resistive load. In a clean environment, electrical life at low level current is 10 million operations at 12V, 5mA, resistive load.																																																																																										
Thermal current	I _{th} = 10A per IEC 947-5-1																																																																																										
Insulation voltage	U _i = 660 Volts AC/DC (opposite polarity) except 2NO & 2NC blocks 300V AC/DC																																																																																										
Protection from electrical shock	Class I per IEC 536 for metal operators Class II (double insulation) per IEC 536 for plastic operators																																																																																										
Insulation category	Group "C" per VDE 0110																																																																																										
Dielectric strength	2500 Volts																																																																																										
Short circuit protection	10A type gG fuse, per IEC 269.1 & 269.3																																																																																										
Pilot duty ratings	<table border="1" style="width: 100%; border-collapse: collapse;"> <thead> <tr> <th colspan="9">A600 (maximum make volt-amperes = 7200; maximum break volt-amperes = 720; PF = .25)</th> </tr> <tr> <th>Volts (V)</th> <th>12</th> <th>24</th> <th>48</th> <th>60</th> <th>120</th> <th>240</th> <th>480</th> <th>600</th> </tr> </thead> <tbody> <tr> <td>Continuous (A)</td> <td>10</td> <td>10</td> <td>10</td> <td>10</td> <td>10</td> <td>10</td> <td>10</td> <td>10</td> </tr> <tr> <td>Making (A)</td> <td>100</td> <td>100</td> <td>100</td> <td>100</td> <td>60</td> <td>30</td> <td>15</td> <td>12</td> </tr> <tr> <td>Breaking (A)</td> <td>10</td> <td>10</td> <td>10</td> <td>10</td> <td>6</td> <td>3</td> <td>1.5</td> <td>1.2</td> </tr> </tbody> </table> <table border="1" style="width: 100%; border-collapse: collapse;"> <thead> <tr> <th colspan="9">Q300 (maximum make or break volt-amperes = 69)</th> </tr> <tr> <th>Volts (V)</th> <th>12</th> <th>24</th> <th>48</th> <th>60</th> <th>125</th> <th>250</th> <th>300</th> <th></th> </tr> </thead> <tbody> <tr> <td>Continuous (A)</td> <td>2.5</td> <td>2.5</td> <td>2.5</td> <td>2.5</td> <td>2.5</td> <td>2.5</td> <td>2.5</td> <td></td> </tr> <tr> <td>Making (A)</td> <td>2.5</td> <td>2.5</td> <td>1.4</td> <td>1.1</td> <td>0.55</td> <td>0.27</td> <td>0.23</td> <td></td> </tr> <tr> <td>Breaking (A)</td> <td>2.5</td> <td>2.5</td> <td>1.4</td> <td>1.1</td> <td>0.55</td> <td>0.27</td> <td>0.23</td> <td></td> </tr> </tbody> </table>	A600 (maximum make volt-amperes = 7200; maximum break volt-amperes = 720; PF = .25)									Volts (V)	12	24	48	60	120	240	480	600	Continuous (A)	10	10	10	10	10	10	10	10	Making (A)	100	100	100	100	60	30	15	12	Breaking (A)	10	10	10	10	6	3	1.5	1.2	Q300 (maximum make or break volt-amperes = 69)									Volts (V)	12	24	48	60	125	250	300		Continuous (A)	2.5	2.5	2.5	2.5	2.5	2.5	2.5		Making (A)	2.5	2.5	1.4	1.1	0.55	0.27	0.23		Breaking (A)	2.5	2.5	1.4	1.1	0.55	0.27	0.23	
A600 (maximum make volt-amperes = 7200; maximum break volt-amperes = 720; PF = .25)																																																																																											
Volts (V)	12	24	48	60	120	240	480	600																																																																																			
Continuous (A)	10	10	10	10	10	10	10	10																																																																																			
Making (A)	100	100	100	100	60	30	15	12																																																																																			
Breaking (A)	10	10	10	10	6	3	1.5	1.2																																																																																			
Q300 (maximum make or break volt-amperes = 69)																																																																																											
Volts (V)	12	24	48	60	125	250	300																																																																																				
Continuous (A)	2.5	2.5	2.5	2.5	2.5	2.5	2.5																																																																																				
Making (A)	2.5	2.5	1.4	1.1	0.55	0.27	0.23																																																																																				
Breaking (A)	2.5	2.5	1.4	1.1	0.55	0.27	0.23																																																																																				

Technical Data

Contact Data																																					
IEC utilization categories	<p>AC15 Control Of AC Electromagnetic Loads Rated operational voltage and current</p> <table style="width: 100%; border-collapse: collapse; font-size: small;"> <tr> <td style="border: none;">Ue (V)</td> <td style="border: none;">12</td> <td style="border: none;">24</td> <td style="border: none;">48</td> <td style="border: none;">60</td> <td style="border: none;">110</td> <td style="border: none;">220</td> <td style="border: none;">380</td> <td style="border: none;">500</td> <td style="border: none;">600</td> </tr> <tr> <td style="border: none;">Ie (A)</td> <td style="border: none;">10</td> <td style="border: none;">10</td> <td style="border: none;">10</td> <td style="border: none;">10</td> <td style="border: none;">6</td> <td style="border: none;">3</td> <td style="border: none;">2</td> <td style="border: none;">1.5</td> <td style="border: none;">1.2</td> </tr> </table> <p>DC13 Control Of DC Electromagnets Rated operational voltage and current</p> <table style="width: 100%; border-collapse: collapse; font-size: small;"> <tr> <td style="border: none;">Ue (V)</td> <td style="border: none;">12</td> <td style="border: none;">24</td> <td style="border: none;">48</td> <td style="border: none;">60</td> <td style="border: none;">110</td> <td style="border: none;">220</td> <td style="border: none;">300</td> </tr> <tr> <td style="border: none;">Ie (A)</td> <td style="border: none;">2.5</td> <td style="border: none;">2.5</td> <td style="border: none;">1.4</td> <td style="border: none;">1.0</td> <td style="border: none;">0.55</td> <td style="border: none;">0.27</td> <td style="border: none;">0.2</td> </tr> </table>	Ue (V)	12	24	48	60	110	220	380	500	600	Ie (A)	10	10	10	10	6	3	2	1.5	1.2	Ue (V)	12	24	48	60	110	220	300	Ie (A)	2.5	2.5	1.4	1.0	0.55	0.27	0.2
Ue (V)	12	24	48	60	110	220	380	500	600																												
Ie (A)	10	10	10	10	6	3	2	1.5	1.2																												
Ue (V)	12	24	48	60	110	220	300																														
Ie (A)	2.5	2.5	1.4	1.0	0.55	0.27	0.2																														
Contact characteristics	<p>NC: slow make, double break (positive opening) NO: slow make, double break Self-cleaning (wiping action) contact Double-bridge contacts with four points of contact</p>																																				
Contact resistance	≤25mOhm per IEC 255.7 category 3																																				
Contact fidelity	<p>Minimum current: 5 mA Minimum voltage: 12 V AC/DC</p>																																				
Logic reed contact data	<p>NC: Single break NO: Single break 120V AC maximum, 0.15A maximum, 8VA maximum 30V DC maximum, .15A maximum, 4.5W maximum</p>																																				
Mounting																																					
Acceptable panel thickness	.040-.236 inches (1-6mm)																																				
Operator locking ring torque	26 in-lbs (3 N-m)																																				
Force required to forcibly remove contact blocks and flange	<p>Contact block or power supply from flange: 27 lb (118 N) 3- or 5-block flange from metal operator: 88 lb (392 N) 3- or 5-block flange from plastic operator: 66 lb (294 N)</p>																																				
Mounting dimensions	<p style="font-size: x-small; text-align: center;">Dimensions shown in inches/millimeters</p>																																				
Mechanical Life Ratings For Operators																																					
	<table style="width: 100%; border-collapse: collapse;"> <thead> <tr> <th style="text-align: left; border-bottom: 1px solid black;">Operators</th> <th style="text-align: left; border-bottom: 1px solid black;">Number Of Operations</th> </tr> </thead> <tbody> <tr><td style="border-bottom: 1px solid black;">Standard push buttons</td><td style="border-bottom: 1px solid black;">3,000,000</td></tr> <tr><td style="border-bottom: 1px solid black;">Illuminated push buttons</td><td style="border-bottom: 1px solid black;">1,000,000-3,000,000¹</td></tr> <tr><td style="border-bottom: 1px solid black;">Momentary mushroom-head push buttons</td><td style="border-bottom: 1px solid black;">3,000,000</td></tr> <tr><td style="border-bottom: 1px solid black;">Maintained mushroom-head push buttons</td><td style="border-bottom: 1px solid black;">500,000</td></tr> <tr><td style="border-bottom: 1px solid black;">Push to latch, turn to release mushroom-head push buttons</td><td style="border-bottom: 1px solid black;">300,000</td></tr> <tr><td style="border-bottom: 1px solid black;">3 position mushroom-head push buttons</td><td style="border-bottom: 1px solid black;">300,000</td></tr> <tr><td style="border-bottom: 1px solid black;">Non-illuminated selector switches</td><td style="border-bottom: 1px solid black;">1,000,000</td></tr> <tr><td style="border-bottom: 1px solid black;">Illuminated selector switches</td><td style="border-bottom: 1px solid black;">500,000</td></tr> <tr><td style="border-bottom: 1px solid black;">Joysticks</td><td style="border-bottom: 1px solid black;">500,000</td></tr> <tr><td style="border-bottom: 1px solid black;">Toggle switches</td><td style="border-bottom: 1px solid black;">500,000</td></tr> <tr><td style="border-bottom: 1px solid black;">Wobble sticks</td><td style="border-bottom: 1px solid black;">1,000,000</td></tr> <tr><td style="border-bottom: 1px solid black;">Key operated push buttons</td><td style="border-bottom: 1px solid black;">500,000</td></tr> <tr><td style="border-bottom: 1px solid black;">Selector push buttons</td><td style="border-bottom: 1px solid black;">1,000,000</td></tr> </tbody> </table>	Operators	Number Of Operations	Standard push buttons	3,000,000	Illuminated push buttons	1,000,000-3,000,000 ¹	Momentary mushroom-head push buttons	3,000,000	Maintained mushroom-head push buttons	500,000	Push to latch, turn to release mushroom-head push buttons	300,000	3 position mushroom-head push buttons	300,000	Non-illuminated selector switches	1,000,000	Illuminated selector switches	500,000	Joysticks	500,000	Toggle switches	500,000	Wobble sticks	1,000,000	Key operated push buttons	500,000	Selector push buttons	1,000,000								
Operators	Number Of Operations																																				
Standard push buttons	3,000,000																																				
Illuminated push buttons	1,000,000-3,000,000 ¹																																				
Momentary mushroom-head push buttons	3,000,000																																				
Maintained mushroom-head push buttons	500,000																																				
Push to latch, turn to release mushroom-head push buttons	300,000																																				
3 position mushroom-head push buttons	300,000																																				
Non-illuminated selector switches	1,000,000																																				
Illuminated selector switches	500,000																																				
Joysticks	500,000																																				
Toggle switches	500,000																																				
Wobble sticks	1,000,000																																				
Key operated push buttons	500,000																																				
Selector push buttons	1,000,000																																				
<p>¹ Number of operations dependent on the operating duration of the lamp. If the lamp is left on for long periods of time, its heat can reduce mechanical life. All illuminated push buttons meet at least 1,000,000 operations.</p>																																					



勝特力材料 886-3-5753170
 勝特力电子(上海) 86-21-54151736
 勝特力电子(深圳) 86-755-83298787
[Http://www.100y.com.tw](http://www.100y.com.tw)

C-2000™ Push Buttons

Technical Data

Electrical Life Ratings For Contacts

Electrical Life – 50/60Hz alternating current
 (inductive) per utilization category AC15

Number Of
 Operations
 (In Millions)

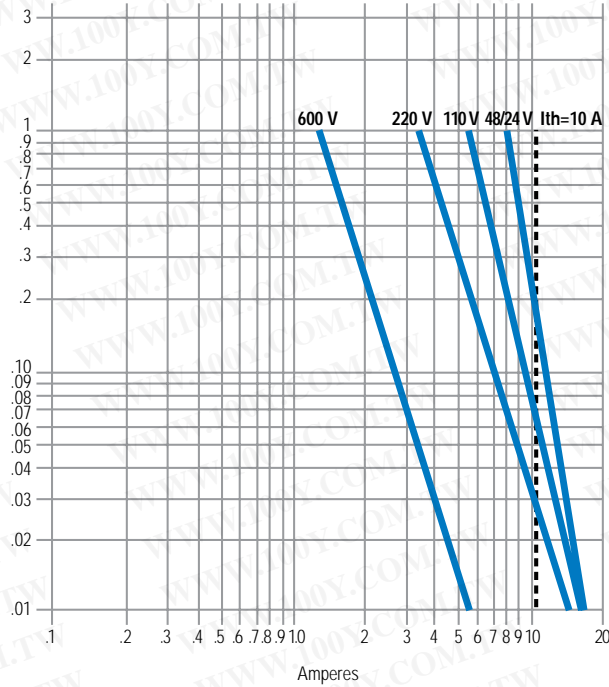

Electrical Life – direct current (inductive)
 per utilization category DC13

Number Of
 Operations
 (In Millions)

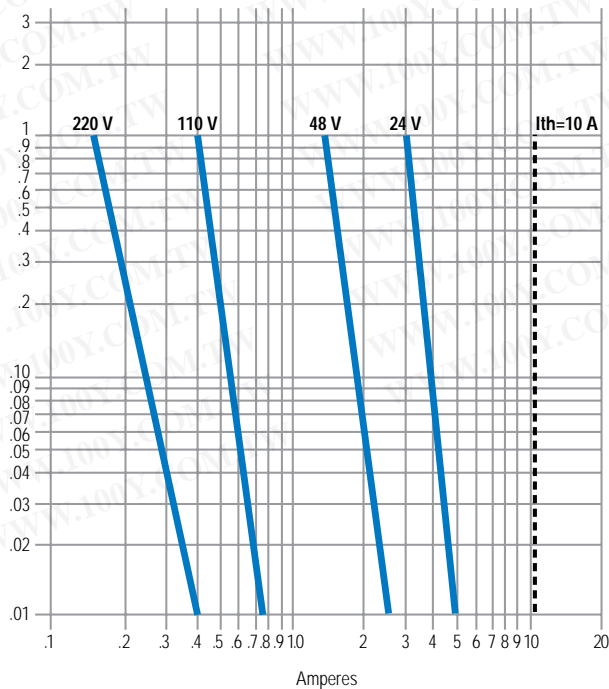

Technical Data

Materials		
	Component	Material
	Cap/levers/knobs (non-illuminated)	Polyamide/acetal
	Cap/levers/knobs (illuminated)	Polycarbonate
	Metal housing	Copper-nickel-chrome plated zinc/aluminum alloy
	Plastic housing	Polyamide/acetal
	Plunger	Polyester
	Springs	Stainless steel
	Body-to-panel gasket	Polyester elastomer
	Cap-to-body gasket	Vinyl nitrile rubber
	Lubricant	Lithium grease
	Cams for non-illuminated selector switches	Polyamide/acetal
	Cams for illuminated selector switches	Polyester
	Cam followers	Polyamide/acetal
	Contact block and power supply housings	Polyamide/acetal
	Contacts	Pure silver
	Conductors	Brass alloy
	Flanges	Polyamide/acetal
	Flange latches	Polyamide/acetal
	Printed circuit board adapter	Polyamide/acetal
	Joystick protective housing	Vinyl nitrile rubber
	Joystick plunger, lever & cam	Acetal resin
	Joystick actuator	Polyamide/acetal
	Push to latch, turn to release actuator & plunger	Polyamide/acetal
	Wobble stick	Polycarbonate
	Toggle switch lever	Polyamide/acetal
	Protective caps (clear)	Silicon rubber
	Protective caps (colored)	Vinyl nitrile rubber
	Push button protective guards	Polycarbonate
	Mushroom-head guards	Polyamide/acetal
	Padlockable cover	Polycarbonate and zinc-plated zinc/aluminum alloy
	Metal locking rings	Zinc-plated zinc/aluminum alloy
	Keys	Plated brass
	Nameplate holders	Polyamide/acetal
	Nameplate inserts	Laminated polyester
	Hole plug	Polyamide/acetal
Power Supply Selection		
Type	Principle of Operation	Benefit
Full voltage	Supplies input voltage directly to bulb.	Smallest and least expensive. Can be used with LEDs.
Transformer	Utilizes a transformer to step the input voltage down to 6 volts.	Transformer has the effect of damping the inrush current and voltage spikes from the switching device seen when the light is turned on, actually protecting the bulb from these factors that shorten life. Generates less heat than the resistor power supplies. Reduces unsafe supply voltages (up to 600V) down to a safe level for lamp servicing. Can be used with LEDs. Able to withstand a short circuit of the lamp or lamp socket without damage.
Normal resistor	Utilizes a resistor in series with the incandescent lamp to drop the lamp voltage to 50% of the input voltage.	Least expensive way to reduce unsafe supply voltages (up to 240V) down to a safe level for lamp servicing.
Diode resistor	Utilizes a resistor and a diode in series with the lamp to rectify and drop a 240VAC input voltage to operate a 130V incandescent lamp.	Provides the same function as the normal resistor, but takes up only one position in the flange rather than two. Generates less heat than the normal resistor power supplies.
Long life resistor	Utilizes a resistor in series with the 130V incandescent lamp to provide a lamp voltage 80% that of the input voltage.	Extends life of a 130V incandescent bulb by 1300% (from 2000 to 28,000 hours).
Flashing (full voltage or transformer)	Utilizes a flashing circuit which can be enabled or disabled by externally switching (shorting) two connections.	Allows the lamp to be switched between OFF, ON, and FLASHING modes.
Panel test (full voltage or standard resistor)	Utilizes a diode to isolate the lamp test circuit from the supply circuit	Allows use of indicating lights and "panel test" feature rather than individual push to test illuminated push buttons. Eliminates the need for the NO/NC contacts used on conventional push-to-test pilot lights.



勝特力材料 886-3-5753170
 勝特力电子(上海) 86-21-54151736
 勝特力电子(深圳) 86-755-83298787
 Http://www.100y.com.tw

C-2000™ Push Buttons

Technical Data

Panel Test Power Supplies

This table shows the maximum number of panel test power supplies to be switched by a single contact block. Multiple switching contact blocks may be used.

Supply Voltage	Maximum Panel Test Power Supplies Per Contact Block	
	AC	DC
6	15	15
12	30	30
24	60	60
48	120	66
60	150	66
130	300	72

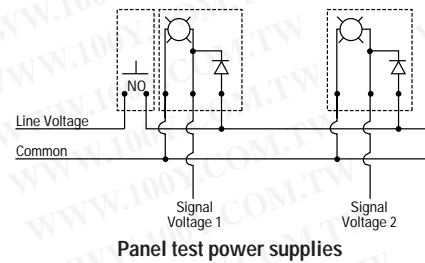
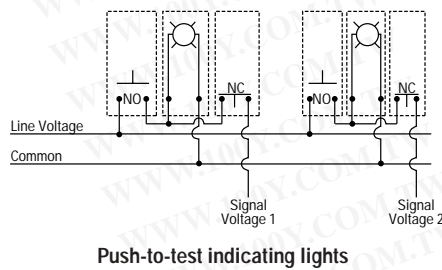

Maximum Number Of Contacts¹

Operator Type	Power Supply Type	Standard 3-block Flange	Optional 5-block Flange
Push button	—	4	8
Mushroom-head push button	—	4	8
Wobble stick	—	4	8
Non-illuminated selector switch	—	4	8
Key selector switch	—	4	8
Illuminated push button	Full voltage, diode & resistor, long life resistor	4	8
Illuminated mushroom-head push button	Standard resistor, panel test, standard transformer	2	6
Illuminated push button	All flashing/continuous	0	4
Illuminated mushroom-head push button	Standard resistor, panel test, standard transformer	2	6
Illuminated selector switch	Full voltage, diode & resistor, long life resistor	4	4
Illuminated selector switch	Standard resistor, panel test, standard transformer	2	4
Illuminated selector switch	All flashing/ continuous	0	4
Push-pull mushroom-head push button	—	2	2
Push twist-to-reset mushroom-head	—	2	2
Push key-to-reset mushroom-head	—	2	2
Illuminated push-pull mushroom-head push button	Full voltage, diode & resistor, long life resistor	2	2
Illuminated push-pull mushroom-head push button	Standard resistor, panel test, standard transformer	2	2
Illuminated push-pull mushroom-head push button	All flashing/ continuous	0	2
Joystick	—	4	8
Key-operated push button	—	4	8
Selector push button	—	4	8
Toggle switch	—	4	4
Multi-function push button (for each button)	—	2 + 2	4 + 4
Illuminated multi-function push button (for each button)	Full voltage, diode & resistor, long life resistor	2 + 2	4 + 4
Illuminated multi-function push button (for each button)	Standard resistor, panel test, standard transformer	0 + 2	2 + 4
Illuminated multi-function push button (for each button)	All flashing/ continuous	0 + 0	2 + 2
All operator types when used in plastic enclosures	—	2	—

¹ In some cases, the maximum number of contacts shown is less than the available number of flange positions. This is because, in these instances, contact block force would affect operation of the device or reduce operator life below values cited elsewhere. For specific application assistance, contact your local GE Industrial Systems sales office.

Technical Data

Lamp Selection

Incandescent, neon and light emitting diode (LED) lamps are available for use in indicating lights, illuminated push buttons and illuminated selector switches. Although incandescent lamps have traditionally been the most frequently used, it is wise to review the characteristics of the different types of lamps and select the one that is most appropriate for the application. Although the incandescent lamp offers the lowest initial cost, the LED is usually the most economical over the long term, due to its long life, resistance to shock and vibration, and lower power consumption. Benefits of LEDs include:

- **Resistance to shock and vibration** — Since LEDs are solid state, they are completely impervious to the problems associated with shock and vibration that can significantly reduce the life of incandescent lamps by mechanically breaking the filament. The high inrush currents at startup associated with incandescent lamps also act to significantly reduce the life of lamps used in frequent on-off applications.
- **Longer life** — The LEDs used with C-2000 push buttons have a service life of 100,000 hours (11 years) compared to 20,000 hours (28 months) for the neon lamps, and 2,000 hours (3 months) for the standard incandescent lamps.
- **Reduced power consumption** — The LEDs used for the C-2000 push buttons consume between 10% and 52% less power than the equivalent BA9S incandescent lamp. The table below shows the power consumption of each type:

Volts AC/DC	Incandescent	Watts	LED	Watts	Neon	Watts
6	BA9S606	0.6	080BA9S6L*	0.59	—	—
6	BA9S615	1.5	—	—	—	—
12	BA9S12	2.0	080BA9S12L*	0.78	—	—
24	BA9S24	2.0	080BA9S24L*	0.84	—	—
48	BA9S48	2.0	080BA9S48L*	1.12	—	—
60	BA9S6012	1.2	—	—	—	—
110	—	—	—	—	BA9SN110	0.077
120	—	—	080BA9S120L*	1.4	—	—
130	BA9S130	2.0	—	—	—	—
220	—	—	—	—	BA9SN220	0.330

- **Lower operating temperature** — Because of the lower power consumption and greater efficiency of LEDs, they operate much cooler than incandescent lamps. Thus, in applications where heat in the enclosure could be a problem, LED lamps are a better choice.

Incandescent bulbs are recommended for light duty applications and panels not subject to shock and vibration. Neon lamps offer a middle ground, at a cost and performance between the LED and the incandescent, but can have problems associated with flicker induced by noise and frequency. LED lamps offer the best overall performance for the long term.

Lamp Comparison

Bulb Type	Approx. Lifespan (hours)	Shock & Vibration Immunity	Operating Temperature	Power Consumption	Brightness
LED	100,000	High	Medium	Medium	Medium
Incandescent	2,000	Low	High	High	High
Neon	20,000	Medium	Low	Low	Low

Guideform Specifications

IEC 22 mm push buttons shall be type GE C-2000™ series. They shall be listed by Underwriters Laboratories (UL), certified by Canadian Standards Association (CSA) and conform to International Electrotechnical Commission (IEC) and Japanese Industrial Standard (JIS) standards. All push buttons, selector switches and pilot lights shall conform to the applicable requirements of NEMA standard ICS-2 for AC and DC control circuits. Enclosures shall be listed by UL and certified by CSA.

Standard features shall include:

- Fully automated manufacturing with 100% on line inspection.
- Manufactured in ISO 9000 certified facility.
- 4 different operator styles: round metal body with polished chrome finish, round metal body with satin chrome finish, black round engineered plastic body and black square engineered plastic body.
- Contact blocks and power supplies completely interchangeable among all 4 styles of operators.
- Locking rings that tighten from the rear with a special wrench or flat blade screwdriver.
- Contact block flanges that mount on operators with 4-point positive locking.
- Universal mounting design that permits push buttons to be mounted with or without locating notch punched in panel. Orientation tab on operator notch that is removable with screwdriver.
- Modular assembly incorporating snap-on contact blocks and power supplies, removable with flat blade screw driver.
- Devices mount on 30 mm x 50 mm (1.18" x 1.97") center.
- Devices mount on panel thickness of 1 to 6 mm (.040" to .236").
- Captive front-of-panel gasket for superior sealing.
- Lamps removable from the front of the panel.
- Metal operators constructed of die cast body.
- Polished and satin chrome operators feature triple chrome plating.
- Permanent marking of contact blocks by laser etching.
- Double bridge wiping action contact block design for applications from 12 - 600 volts AC and 12 - 300 volts DC.
- PLC interfacing with standard contact blocks.
- Contact blocks rated for 10 million electrical operations at 12 volts, 5 milliamps.
- Contact block cases shall be ultrasonically welded to provide superior protection in dust conditions. Contact blocks rated for 250,000 operations at 12 volts, 5 milliamps in severely dusty conditions.
- Power supplies shall be available in full voltage, resistor and transformer forms.
- Resistor power supplies shall be available in standard, diode and long-life forms.
- Screw, quick connect and base mount contact blocks.
- Printed circuit board connector for use with quick connect contact blocks.
- Global nomenclature.
- Multi-lingual nameplates.
- Global availability.



勝特力材料 886-3-5753170
 勝特力电子(上海) 86-21-54151736
 勝特力电子(深圳) 86-755-83298787
[Http://www.100y.com.tw](http://www.100y.com.tw)

C-2000™ Push Buttons

Nomenclature Keys

For use in interpreting catalog numbers only. Do not use for developing catalog numbers.

Standard & Illuminated Push Buttons

Style	Illumination	Cap Color	Push Button Type	Lens Type
P	P			
9				

C = Polished chrome
M = Satin chrome
X = Round plastic
S = Square plastic

N = Non-illuminated
L = Illuminated

O = No Cap
N = Black
R = Red
V = Green
G = Yellow
L = Blue
B = White
M = Brown
H = Gray
A = Orange
I = Clear

G = Flush
S = Extended
E = Recessed

D = Diffused
R = Refracted
V = Glass
O = No lens

Pilot Lights

Style	Cap Color	Lens Type
P		
9		
L		

C = Polished chrome
M = Satin chrome
X = Round plastic
S = Square plastic

R = Red
V = Green
G = Yellow
L = Blue
B = White
I = Clear
A = Orange
O = No cap

D = Diffused
R = Refracted
V = Glass
O = No lens

Mushroom-head Push Buttons

Style	Type	Mushroom-head Diameter	Cap Color	Illumination	Position Type (1 Digit) Or Key Selection (2 Digits)
P	E				
9					

C = Polished chrome
M = Satin chrome
X = Round plastic
S = Square plastic

M = Momentary
T = Push/Pull
R = Turn to reset
C = Key to reset

3 = 28mm
4 = 40mm
6 = 60mm

N = Black
R = Red
V = Green
G = Yellow
L = Blue
B = White
I = Clear
A = Orange

N = Non-illuminated
A = Positive action, non-illuminated
L = Illuminated

Position type
1 = 2-position push/pull
2 = 3-position, maintained push/momentary pull
3 = 3-position, push/pull, spring return to center

Keys
 See keys selection table on page 14.

Knob- & Lever-operated Selector Switches

Style	Operator Type	Cam	Spring Return	Cap Color
P	S			
9				

C = Polished chrome
M = Satin chrome
X = Round plastic
S = Square plastic

M = Knob
V = Lever
L = Illuminated knob

D, I or H = 2-position
E, L, U or Z = 3-position
X = 4-position
Y or W = 5-position

0 = Fixed
1 = From left
3 = From left & right
5 = From right

O = No knob or lever
N = Black
R = Red
V = Green
G = Yellow
L = Blue
B = White
I = Clear
A = Orange

Nomenclature Keys

For use in interpreting catalog numbers only. Do not use for developing catalog numbers.

Key-operated Selector Switches

Style		Cam		Spring Return		Key Removal		Key Selection	
<input type="text" value="P"/>	<input type="text" value="9"/>	<input type="text"/>	<input type="text"/>	<input type="text"/>	<input type="text"/>	<input type="text"/>	<input type="text"/>	<input type="text"/>	<input type="text"/>
C = Polished chrome M = Satin chrome X = Round plastic S = Square plastic			D, I or H = 2-position E, L, U or Z = 3-position X = 4-position		0 = Fixed 1 = From left 3 = From left & right 5 = From right		See key removal table on page 14. See key selection table on page 14.		

Special Operators

Style		Operator Type		Operator-specific Digits For Various Options		
<input type="text" value="P"/>	<input type="text" value="9"/>	<input type="text"/>	<input type="text"/>	<input type="text"/>	<input type="text"/>	<input type="text"/>
C = Polished chrome M = Satin chrome X = Round plastic S = Square plastic		M = Joystick C = Toggle switch W = Wobble stick Z = Potentiometer operator R = Reset push button B = Buzzer				

Multi-function Push Buttons

Style		Illumination		Top Color		Bottom Color		Guard		ISO Symbols	
<input type="text" value="P"/>	<input type="text" value="9"/>	<input type="text" value="D"/>	<input type="text" value="P"/>	<input type="text"/>	<input type="text"/>	<input type="text"/>	<input type="text"/>	<input type="text"/>	<input type="text"/>	<input type="text"/>	
			N = Non-illuminated L = Illuminated		N = Black V = Green		R = Red		G = Flush S = Top flush, bottom extended 00 = No symbols 01 = I (top)/O (bottom)		

Key-operated Push Buttons

Style		Lock position		Key removal		Key selection	
<input type="text" value="P"/>	<input type="text" value="9"/>	<input type="text"/>	<input type="text" value="P"/>	<input type="text" value="C"/>	<input type="text" value="N"/>	<input type="text"/>	<input type="text"/>
C = Polished chrome M = Satin chrome X = Round plastic			1 = Normal 2 = Depressed 3 = Normal & depressed		E = Right K = Left & right		See key selection table on page 14.

Selector Push Buttons

Style		Function				
<input type="text" value="P"/>	<input type="text" value="9"/>	<input type="text"/>	<input type="text" value="P"/>	<input type="text" value="S"/>	<input type="text"/>	<input type="text" value="G"/>
C = Polished chrome M = Satin chrome		2-position 21 = Function 201 22 = Function 231 23 = Function 235 3-position 34 = Function 301 35 = Function 323				



勝特力材料 886-3-5753170
 勝特力电子(上海) 86-21-54151736
 勝特力电子(深圳) 86-755-83298787
 Http://www.100y.com.tw

C-2000™ Push Buttons

Nomenclature Keys

For use in interpreting catalog numbers only. Do not use for developing catalog numbers.

Power Supplies

Type	Style	Terminal Type	Voltage	Lamp
P	9	P		
D = Full voltage T = Transformer R = Resistor	N = Normal D = Diode L = Long life T = Test M = Multi-function (continuous/blinking)	V = Standard screw F = Quick connect B = Base mount screw	See voltage table below	L = LED N = Neon

Contact Blocks

Normally Open Contacts	Normally Closed Contacts	Terminal Type	Contact Type
P	9	B	
0 = 0NO 1 = 1NO 2 = 2NO	0 = 0NC 1 = 1NC 2 = 2NC	V = Standard screw F = Quick connect B = Base mount screw T = Time delay screw	N = Normal A = Early make R = Late opening 3 = Time delay, 0.1-30 sec. 8 = Time delay, 10-180 sec. H = Reed

Accessories & Enclosures

Style	Items & Options			
P	9	A		
R = Round operator accessory S = Square operator accessory C = Common accessory (round & square) M = Multi-function operator accessory E = Base mount enclosure or nameplate	See individual catalog selections			

Key Selection

Key Number	Std.											Special					Colored				
	3095	9901	9902	9903	9904	9905	9910	9916	9919	3353	R455 (Ronis)	73033 (Yellow)	73034 (Black)	73037 (Red)	73038 (Blue)	73040 (Orange)					
Key Code	95	01	02	03	04	05	10	16	19	53	55	33	34	37	38	40					

Key Removal

2- & 3-Position Key Operators	Key Removal Position																		
	L	—	C	—	R	—	L-C	—	L-R	—	—	C-R	—	—	—	L-C-R	—	—	—
4-Position Key Operators	2L	L	—	R	2R	2L-L	—	2L-R	2L-2R	L-R	L-2R	—	2-2R	2L-L-R	2L-L-2R	—	2L-R-2R	L-R-2R	2L-L-R-2R
Key Removal Code	A	B	C	D	E	F	H	J	K	L	M	N	P	R	S	T	U	V	Z

Voltage

Voltage	No lamp	6	12	24	48	60	110	120	110-120	130	220	220-240	220-250	280	380	415-440	480-500	550-600
Voltage code	0	A	B	D	G	H	I	J	J	L	M	N	N	R	U	W	Y	Z

勝特力材料 886-3-5753170
 勝特力电子(上海) 86-21-54151736
 勝特力电子(深圳) 86-755-83298787
 Http://www.100y.com.tw

C-2000™ Push Buttons

Standard Push Buttons



Selection Process

Select operator below	+	Select contact block(s) from back cover fold-out	+	Select nameplate, if required, from pages 36-38	=	Complete unit

Operators

Replace *asterisk (*)* in catalog number with color code digit from colors table below.

Style	Flush Catalog No.	Extended Catalog No.	Recessed Catalog No.	List Price, GO-10GC
● Polished Chrome	P9CPN*G	P9CPN*S	P9CPN*E	\$8.50
○ Satin Chrome	P9MPN*G	P9MPN*S	P9MPN*E	8.50
● Round Engineered Plastic	P9XPN*G	P9XPN*S	—	8.50
□ Square Engineered Plastic	P9SPN*G	P9SPN*S	—	8.50

* Colors

Color	Black	Red	Green	Yellow	Blue	White	Brown	Gray	No Cap ¹
*Color Code	N	R	V	G	L	B	M	H	0

¹ When ordering operator with no cap, deduct \$1.00 from list price.

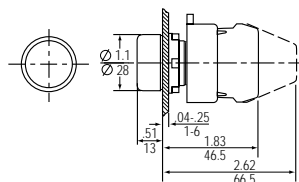

Round Flush Push Button

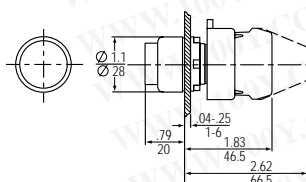

Round Extended Push Button

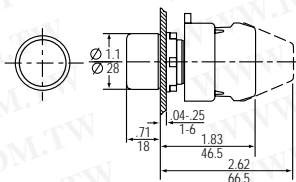

Round Recessed Push Button

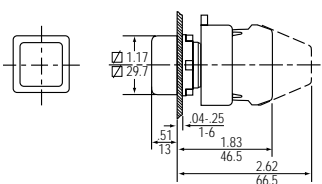

Square Flush Push Button

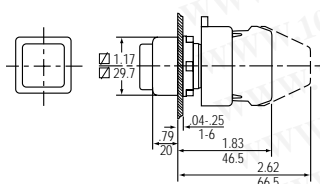

Square Extended Push Button

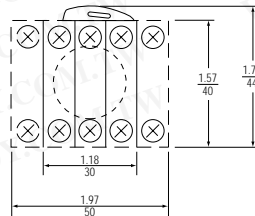

Typical Back Side View

Dimensions shown in inches / millimeters



勝特力材料 886-3-5753170
 勝特力电子(上海) 86-21-54151736
 勝特力电子(深圳) 86-755-83298787
 Http://www.100y.com.tw

C-2000™ Push Buttons

Illuminated Push Buttons



Selection Process

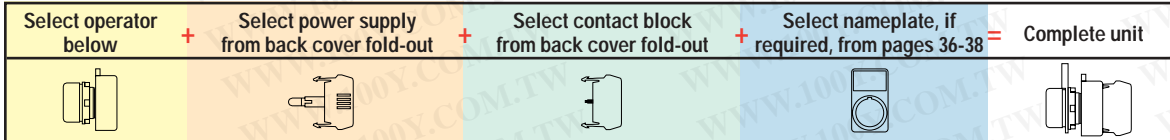

Operators

Replace **asterisk (*)** in catalog number with color code digit from colors table below.

Style	Lens Type	Extended Catalog No.	List Price, GO-10GC	Flush Catalog No.	Recessed Catalog No.	List Price, GO-10GC
● Polished Chrome	Plastic	P9CPL*SD	\$10.50	P9CPL*GD	P9CPL*ED	\$11.50
	Glass	P9CPL*SV	22.50	—	—	—
○ Satin Chrome	Plastic	P9MPL*SD	10.50	P9MPL*GD	P9MPL*ED	11.50
	Glass	P9MPL*SV	22.50	—	—	—
● Round Engineered Plastic	Plastic	P9XPL*SD	10.50	P9XPL*GD	P9XPL*ED	11.50
	Glass	P9XPL*SV	22.50	—	—	—
□ Square Engineered Plastic	Plastic	P9SPL*SD	10.50	P9SPL*GD	P9SPL*ED	11.50

* Colors

Color	Red	Green	Yellow	Blue	White	Orange ¹	Clear ¹	No Lens ²
*Color Code	R	V	G	L	B	A	I	0

¹ Not available in glass lens.

² When ordering illuminated push buttons with no lens, change eighth digit in catalog number from D to 0 and deduct \$1.00 from list price.

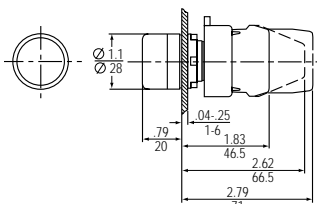

Round Illuminated Flush Push Button

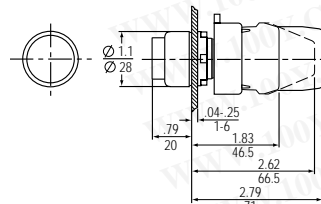

Round Illuminated Extended Push Button

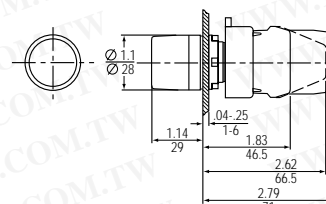

Round Illuminated Recessed Push Button

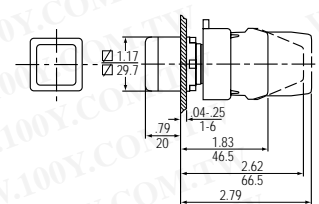

Square Illuminated Flush Push Button

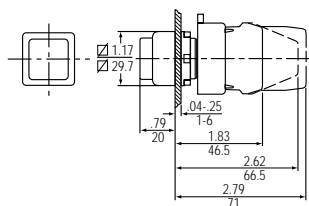

Square Illuminated Extended Push Button

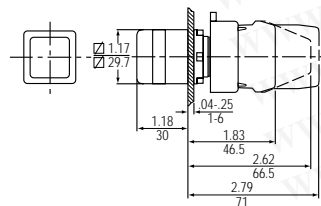

Square Illuminated Recessed Push Button

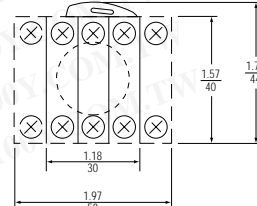

Typical Back Side View

Dimensions shown in
 inches
 millimeters

Selection & drawing data: pages 4-5. Accessories: pages 46-47. Technical data: pages 6-11. Specially marked caps: page 39. Color caps, heads, lenses and handles are also stocked separately: page 41.

勝特力材料 886-3-5753170
 勝特力电子(上海) 86-21-54151736
 勝特力电子(深圳) 86-755-83298787
 Http://www.100y.com.tw

C-2000™ Push Buttons

Mushroom-Head Push Buttons



Selection Process

Select operator below	+	Select contact block(s) from back cover fold-out	+	Select nameplate, if required, from pages 36-38	=	Complete unit

Operators

Momentary & Push To Latch

Replace **asterisk (*)** in momentary catalog number with color code from colors table below.

Replace **dagger (†)** in push to latch-key to release catalog number with key code from keys table below.

Style	Head Diameter	Momentary		Red Push To Latch-Turn Release		Red Push To Latch-Key To Release	
		Catalog No.	List Price, GO-10GC	Catalog No.	List Price, GO-10GC	Catalog No.	List Price, GO-10GC
● Polished Chrome	28mm	P9CEM3*N	\$16.50	P9CER3RN	\$38.50	—	—
	40mm	P9CEM4*N	16.50	P9CER4RN	38.50	P9CEC4RN†	\$53.50
	60mm	P9CEM6*N	18.50	—	—	—	—
○ Satin Chrome	28mm	P9MEM3*N	16.50	P9MER3RN	38.50	—	—
	40mm	P9MEM4*N	16.50	P9MER4RN	38.50	P9MEC4RN†	53.50
	60mm	P9MEM6*N	18.50	—	—	—	—
● Round Engineered Plastic	28mm	P9XEM3*N	16.50	—	—	—	—
	40mm	P9XEM4*N	16.50	P9XER4RA	38.50	P9XEC4RA†	53.50
	60mm	P9XEM6*N	18.50	—	—	—	—
□ Square Engineered Plastic	29mm	P9SEM3*N	16.50	—	—	—	—
	40mm	—	—	P9SER4RA	38.50	P9SEC4RA†	53.50

Catalog numbers shown in bold are positive action push buttons as defined in IEC 947-5. Fully depressing the button guarantees that the NC contacts have been opened by purely mechanical means. Less than full depression of the button guarantees that the NC contact have not been opened.

Push-Pull

Replace **asterisk (*)** in catalog number with color code from colors table below.

Style	Head Diameter	2-Position Maintained		3-Position Maintained Push-Momentary Pull		3-Position Momentary Push-Momentary Pull	
		Catalog No.	List Price, GO-10GC	Catalog No.	List Price, GO-10GC	Catalog No.	List Price, GO-10GC
● Polished Chrome	40mm	P9CET4*N1	\$21.50	P9CET4*N2	\$31.00	P9CET4*N3	\$31.00
○ Satin Chrome	40mm	P9MET4*N1	21.50	P9MET4*N2	31.00	P9MET4*N3	31.00
● Round Engineered Plastic	40mm	P9XET4*N1	21.50	P9XET4*N2	31.00	P9XET4*N3	31.00
□ Square Engineered Plastic	40mm	P9SET4*N1	21.50	P9SET4*N2	31.00	P9SET4*N3	31.00

* Colors

Color	Black	Red	Green	Yellow
*Color Code	N	R	V	G

† Keys (Set Of 2)

Key Number	Std.	Special ¹										Colored ¹				
	3095	9901	9902	9903	9904	9905	9910	9916	9919	3353	R455 (Ronis)	73033 (Yellow)	73034 (Black)	73037 (Red)	73038 (Blue)	73040 (Orange)
†Key Code	95	01	02	03	04	05	10	16	19	53	55	33	34	37	38	40

¹ To order with other than standard key code (95), add \$4.00 to list price, GO-10GC. Minimum quantity order on Key Codes 95, 55 and 33 is one; for all others, minimum quantity order is ten.

Dimensional drawings on page 18.

Selection & drawing data: pages 4-5. Accessories: pages 46-47. Technical data: pages 6-11.
 Color caps, heads, lenses and handles are also stocked separately: page 41.



勝特力材料 886-3-5753170
勝特力电子(上海) 86-21-54151736
勝特力电子(深圳) 86-755-83298787
[Http://www.100y.com.tw](http://www.100y.com.tw)

C-2000™ Push Buttons

Mushroom-Head Push Buttons

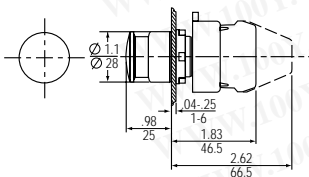

Round Mushroom-head Push Button (28 mm)

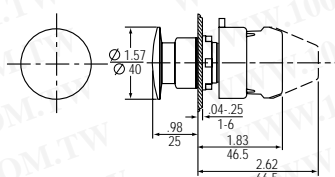

Round Mushroom-head Push Button (40 mm)

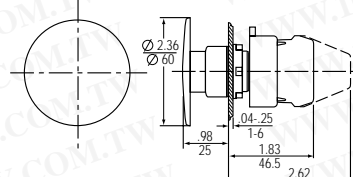

Round Mushroom-head Push Button (60 mm)

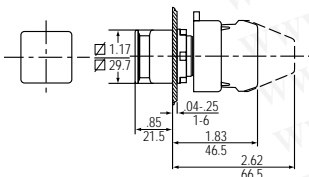

Square Mushroom-head Push Button

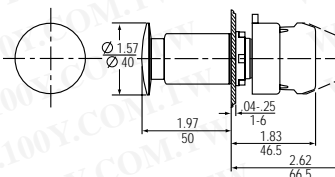

Round Plastic Emergency Stop Twist-To-Reset

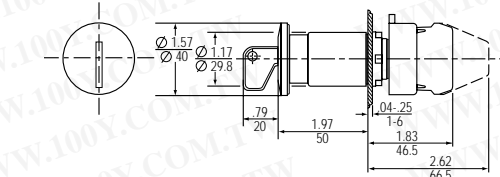

Round Plastic Emergency Stop Key-Reset

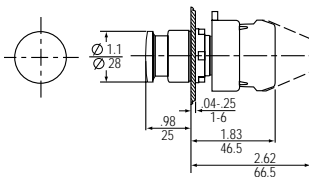

Round Metal Emergency Stop Twist-To-Reset (28 mm)

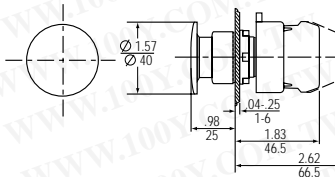

Round Metal Emergency Stop Twist-To-Reset (40 mm)

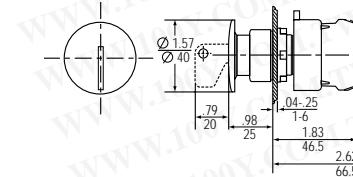

Round Metal Emergency Stop Key-Reset

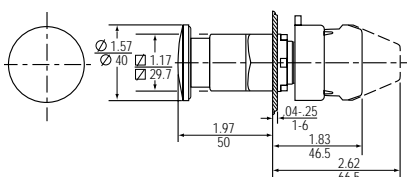

Square Emergency Stop Twist-To-Reset

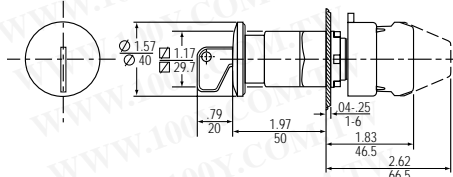

Square Emergency Stop Key-Reset

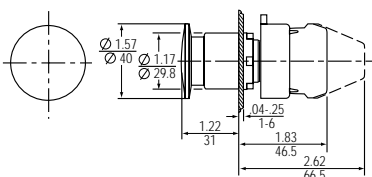

Round Push-Pull Mushroom-head Push Button

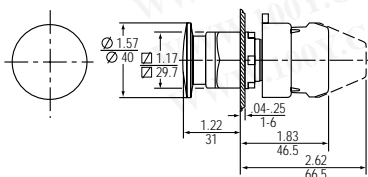

Square Push-Pull Mushroom-head Push Button

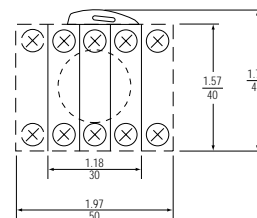

Typical Back Side View

Dimensions shown in inches / millimeters

Illuminated Mushroom-Head Push Buttons



Selection Process

Select operator below	+	Select power supply from back cover fold-out	+	Select contact block from back cover fold-out	+	Select nameplate, if required, from pages 36-38	=	Complete unit

Operators

Replace **asterisk (*)** in catalog number with color code digit from colors table below.

Style	Head Diameter	Push-Pull						List Price, GO-10GC
		Momentary		2-Position Maintained		3-Position Maintained Push-Momentary Pull	3-Position Momentary Push-Momentary Pull	
		Catalog No.	List Price, GO-10GC	Catalog No.	List Price, GO-10GC	Catalog No.	Catalog No.	
○ Polished Chrome	40mm	P9CEM4*L	\$16.50	P9CET4*L1	\$23.50	P9CET4*L2	P9CET4*L3	\$31.00
○ Satin Chrome	40mm	P9MEM4*L	16.50	P9MET4*L1	23.50	P9MET4*L2	P9MET4*L3	31.00
● Round Engineered Plastic	40mm	P9XEM4*L	16.50	P9XET4*L1	23.50	P9XET4*L2	P9XET4*L3	31.00
□ Square Engineered Plastic	29mm	P9SEM3*L	16.50	—	—	—	—	—
	40mm	—	—	P9SET4*L1	23.50	P9SET4*L2	P9SET4*L3	31.00

*Colors

Color	Red	Green	Yellow	Blue	White	Orange	Clear
*Color Code	R	V	G	L	B	A	I

Cams

Note selection and position of contact block(s).

Operator Type Cam	Position			Screw Terminal Contact Block		Quick Connect Contact Block	
	Push	Center	Pull	Position 1	Position 2	Position 1	Position 2
Maintained Push, Momentary Pull	O	X	X	P9B01VR	—		
	O	O	X	—	P9B01VN		
Momentary Push-Momentary Pull	X	O	O	—	P9B10VN	—	P9B10FN
	O	O	X	P9B01VN	—	P9B01FN	—
	X	O	O	P9B11VN	—	—	—

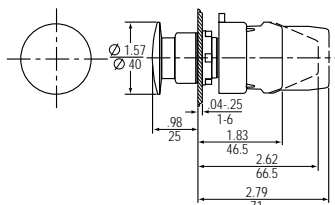
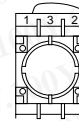

Round Illuminated Mushroom-head Push Button (40 mm)

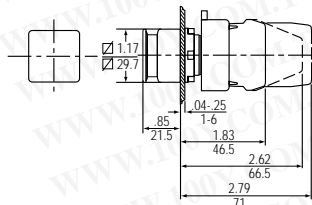

Square Illuminated Mushroom-head Push Button

Dimensions shown in $\frac{\text{inches}}{\text{millimeters}}$

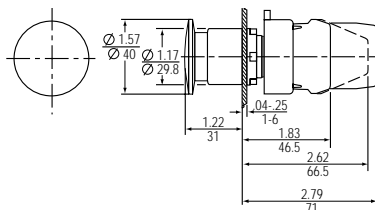

Round Illuminated Push-Pull Mushroom-head Push Button

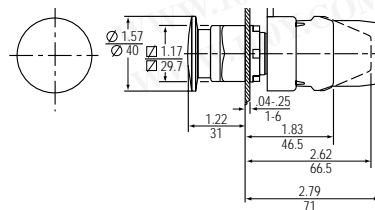

Square Illuminated Push-Pull Mushroom-head Push Button

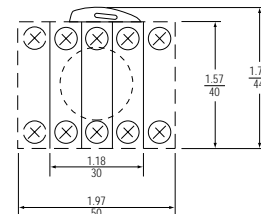

Typical Back Side View

Selection & drawing data: pages 4-5. Accessories: pages 46-47. Technical data: pages 6-11.
 Color caps, heads, lenses and handles are also stocked separately: page 41.



勝特力材料 886-3-5753170
 勝特力电子(上海) 86-21-54151736
 勝特力电子(深圳) 86-755-83298787
[Http://www.100y.com.tw](http://www.100y.com.tw)

C-2000™ Push Buttons

Pilot Lights



Selection Process

Select operator below	+	Select power supply from back cover fold-out	+	Select nameplate, if required, from pages 36-38	=	Complete unit

Operators

Replace **asterisk (*)** in catalog number with color code digit from colors table below.

Style	Lighting	Catalog No.	List Price, GO-10GC
● Polished Chrome	Diffused	P9CL*D	\$6.00
	Refracted	P9CL*R	6.00
	Glass Lens	P9CL*V	18.50
	No Lens or Diffuser	P9CL00	5.00
○ Satin Chrome	Diffused	P9ML*D	6.00
	Refracted	P9ML*R	6.00
	Glass Lens	P9ML*V	18.50
	No Lens or Diffuser	P9ML00	5.00
● Round Engineered Plastic	Diffused	P9XL*D	6.00
	Refracted	P9XL*R	6.00
	Glass Lens	P9XL*V	18.50
	No Lens or Diffuser	P9XL00	5.00
□ Square Engineered Plastic	Diffused	P9SL*D	7.00
	No Lens	P9SL00	6.00
Unibloc ¹	Full Voltage, Diffused	P9XU*DD0	12.00
	Full Voltage, Refracted	P9XU*RD0	12.00
	Resistor, Diffused	P9XU*DRN	23.00
	Resistor, Refracted	P9XU*RRN	23.00
	Full Voltage, No Lens or Diffuser	P9XU00D0	11.00
	Resistor, No Lens or Diffuser	P9XU00RN	22.00

¹ Available only as a pilot light, Unibloc combines an indicator light and power source in one unit, producing a savings for the customer. Full voltage versions do not include lamp; select lamp from p. 48. Resistor versions are 220V (ac/dc) and include BA9S 130V/2W lamp.

* Colors

Color	Red	Green	Yellow	Blue	White	Orange	Clear
*Color Code	R	V	G	L	B	A	I

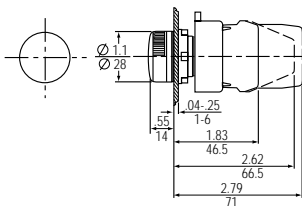

Round Indicating Light

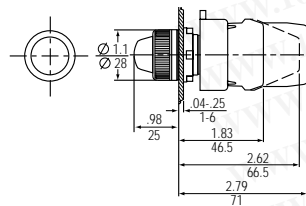

Round Indicating Light — Glass Lens

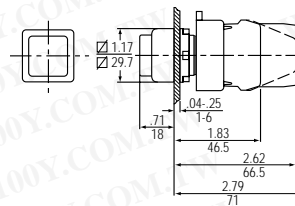

Square Indicating Light

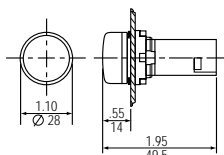

Round Indicating Light - Unibloc

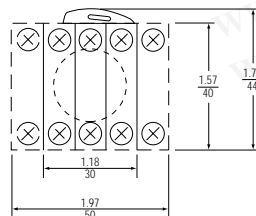

Typical Back Side View

Dimensions shown in $\frac{\text{inches}}{\text{millimeters}}$

Selection & drawing data: pages 4-5. Accessories: pages 46-47. Technical data: pages 6-11. Specially marked diffusers: page 40. Color caps, heads, lenses and handles are also stocked separately: page 41.

勝特力材料 886-3-5753170
 勝特力电子(上海) 86-21-54151736
 勝特力电子(深圳) 86-755-83298787
 Http://www.100y.com.tw

C-2000™ Push Buttons

Push-To-Test Pilot Lights



Selection Process

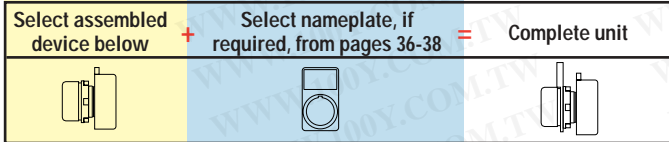

Operators

Replace **asterisk (*)** in catalog number with color code from colors table below.
 Replace **dagger (†)** in catalog number with power supply code from corresponding section of power supplies table below.

Style	Full Voltage Screw Terminal Catalog No.	Full Voltage Quick Connect Terminal Catalog No.	List Price, GO-10GC	Transformer Screw Terminal Catalog No.	List Price, GO-10GC	Standard Resistor Screw Terminal Catalog No.	List Price, GO-10GC
Polished Chrome	P9CPL*SDN12NC†	P9CPL*SDN45ND†	\$48.50	P9CPL*SDN30NH†	\$70.00	P9CPL*SDN30NK†	\$60.00
Satin Chrome	P9MPL*SDN12NC†	P9MPL*SDN45ND†	48.50	P9MPL*SDN30NH†	70.00	P9MPL*SDN30NK†	60.00
Round Engineered Plastic	P9XPL*SDN12NC†	P9XPL*SDN45ND†	48.50	P9XPL*SDN30NH†	70.00	P9XPL*SDN30NK†	60.00
Square Engineered Plastic	P9SPL*SDN12NC†	P9SPL*SDN45ND†	48.50	P9SPL*SDN30NH†	70.00	P9SPL*SDN30NK†	60.00

* Colors

Color	Red	Green	Yellow	Blue	White	Orange	Clear	No Lens ¹
*Color Code	R	V	G	L	B	A	I	0

¹ When ordering push-to-test pilot light with no lens, deduct \$1.00 from list price.

† Power Supplies

Power Supply Type	Lamp	Incandescent Bulb	LED Bulb
		†Power Supply Code	†Power Supply Code ²
Full Voltage (AC/DC)	6V	AI	AL
	12V	BI	BL
	24V	DI	DL
	48V	GI	GL
	60V	HI	—
	120V (AC only)	—	JL
Transformer (AC only)	130V	LI	—
	48V	GI	GL
	60V	HI	HL
	110-120V	JI	JL
	220-250V	NI	NL
	277V	RI	RL
	380V	UI	UL
	415-440V	VI	VL
Standard Resistor (AC/DC)	480-500V	YI	YL
	550-600V	ZI	ZL
	110-120V	JL	—
	220-240V	NI	—

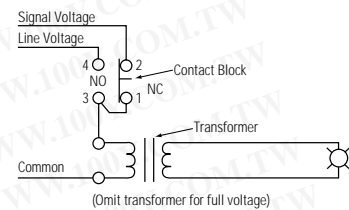

² When ordering operator with LED add \$15.00 to list price. Available for red, green, yellow, white and orange lenses only.



勝特力材料 886-3-5753170
 勝特力电子(上海) 86-21-54151736
 勝特力电子(深圳) 86-755-83298787
 Http://www.100y.com.tw

C-2000™ Push Buttons

2-Position Knob- & Lever-Operated Selector Switches



Selection Process

Select operator below	+	Select contact block(s) from back cover fold-out	+	Select nameplate, if required, from pages 36-38	=	Complete unit

Operators

Replace **asterisk (*)** in maintained catalog number with cam code from cams table below.
 Replace **dagger (†)** in catalog number with color code from colors table below.

Style	Handle	Maintained	List Price, GO-10GC	Spring Return L→C (Cam H)	Spring Return L←R (Cam D)	Spring Return C←R (Cam I)	List Price, GO-10GC
		Catalog No.		Catalog No.	Catalog No.		
Polished Chrome	Knob	P9CSM*0†	\$14.50	P9CSMH1†	P9CSMD5†	P9CSMI5†	\$16.50
	Black Lever	P9CSV*0N	14.50	P9CSVH1N	P9CSV5N	P9CSVI5N	16.50
Satin Chrome	Knob	P9MSM*0†	14.50	P9MSMH1†	P9MSMD5†	P9MSMI5†	16.50
	Black Lever	P9MSV*0N	14.50	P9MSVH1N	P9MSV5N	P9MSVI5N	16.50
Round Engineered Plastic	Knob	P9XSM*0†	14.50	P9XSMH1†	P9XSMD5†	P9XSMI5†	16.50
	Black Lever	P9XSV*0N	14.50	P9XSVH1N	P9XSV5N	P9XSVI5N	16.50
Square Engineered Plastic	Knob	P9SSM*0†	14.50	P9SSMH1†	P9SSMD5†	P9SSMI5†	16.50

* Cams

Choose desired cam. Note selection and position of contact block(s).

*Cam Code	Cam D	Cam H	Cam I	Screw Terminal Contact Block		Quick Connect Terminal Contact Block	
				Position 1	Position 2	Position 1	Position 2
D	0	—	X	—	P9B10VN	—	P9B10FN
	X	—	0	P9B01VN	—	P9B01FN	—
	0	—	X	P9B11VN	—	—	—
	X	—	0	—	—	—	—
I	—	0	X	—	P9B10VN	—	P9B10FN
	—	X	0	P9B01VN	—	P9B01FN	—
	—	0	X	P9B11VN	—	—	—
	—	X	0	—	—	—	—
H	X	0	—	—	P9B10VN	—	P9B10FN
	0	X	—	P9B01VN	—	P9B01FN	—
	X	0	—	P9B11VN	—	—	—
	0	X	—	—	—	—	—

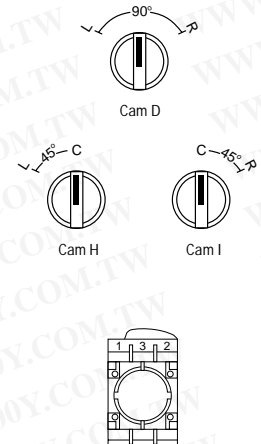

† Colors

Color	Black	Red	Green	Yellow	Blue	No Knob ¹
†Color Code	N	R	V	G	L	0

¹ Subtract \$3.00 from list price, GO-10GC, for selector switches ordered without knobs.

Dimensions shown in inches / millimeters

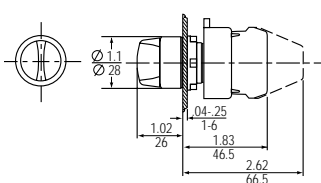

Round Knob Selector Switch

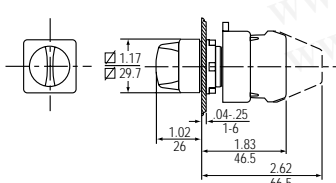

Square Knob Selector Switch

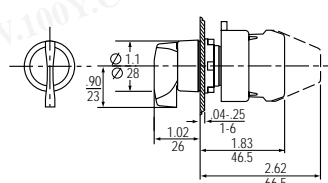

Round Lever Selector Switch

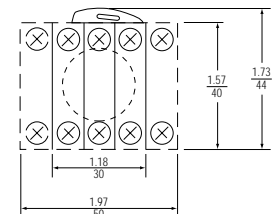

Typical Back Side View

Selection & drawing data: pages 4-5. Accessories: pages 46-47. Technical data: pages 6-11.
 Color caps, heads, lenses and handles are also stocked separately: page 41.

3-Position Knob- & Lever-Operated Selector Switches



Selection Process

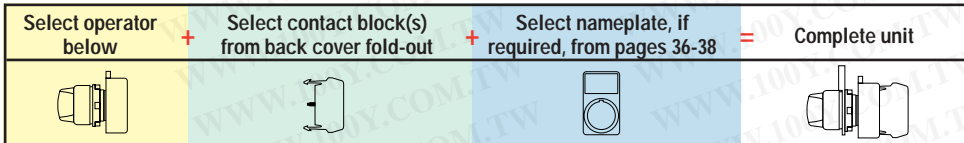

Operators

Replace **asterisk (*)** in catalog number with cam code from cams table below.
 Replace **dagger (†)** in catalog number with color code from colors table below.

Style	Handle	Maintained	List Price,	Spring Return L→C	Spring Return C←R	Spring Return L⇒C←R	List Price,
		Catalog No.	GO-10GC	Catalog No.	Catalog No.	Catalog No.	GO-10GC
Polished Chrome	Knob	P9CSM*0†	\$14.50	P9CSM*1†	P9CSM*5†	P9CSM*3†	\$16.50
	Black Lever	P9CSV*0N	14.50	P9CSV*1N	P9CSV*5N	P9CSV*3N	16.50
Satin Chrome	Knob	P9MSM*0†	14.50	P9MSM*1†	P9MSM*5†	P9MSM*3†	16.50
	Black Lever	P9MSV*0N	14.50	P9MSV*1N	P9MSV*5N	P9MSV*3N	16.50
Round Engineered Plastic	Knob	P9XSM*0†	14.50	P9XSM*1†	P9XSM*5†	P9XSM*3†	16.50
	Black Lever	P9XSV*0N	14.50	P9XSV*1N	P9XSV*5N	P9XSV*3N	16.50
Square Engineered Plastic	Knob	P9SSM*0†	14.50	P9SSM*1†	P9SSM*5†	P9SSM*3†	16.50

*Cams

Choose desired cam. Note selection and position of contact block(s).

*Cam Code				Screw Terminal Contact Block		Quick Connect Terminal Contact Block	
				Position 1	Position 2	Position 1	Position 2
Z	0	0	X	P9B10VN	—	P9B10FN	—
	X	0	0	—	P9B10VN	—	P9B10FN
	X	X	0	P9B01VN	—	P9B01FN	—
	0	X	X	—	P9B01VN	—	P9B01FN
	0	0	X	P9B11VN	—	—	—
	X	X	0	—	P9B11VN	—	—
E	0	0	X	—	P9B01VN	—	P9B01FN
	0	X	0	P9B10VN	—	P9B10FN	—
	0	0	X	P9B11VN	—	—	—
L	X	0	0	—	P9B10VN	—	P9B10FN
	0	X	0	P9B01VN	—	P9B01FN	—
	X	0	0	P9B11VN	—	—	—
U	0	0	X	P9B11VN	—	—	—
	0	X	0	—	—	—	—
	X	0	0	—	P9B11VN	—	—

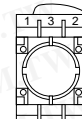
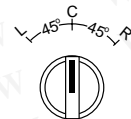

†Colors

Color	Black	Red	Green	Yellow	Blue	No Knob ¹
†Color Code	N	R	V	G	L	0

¹ Subtract \$3.00 from list price, GO-10GC, for selector switches ordered without knobs.

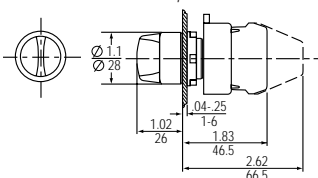

Round Knob Selector Switch

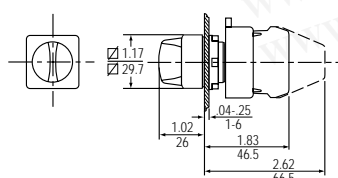

Square Knob Selector Switch

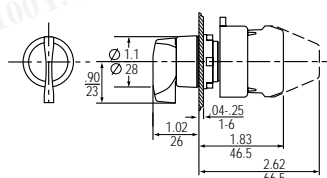

Round Lever Selector Switch

Dimensions shown in inches / millimeters

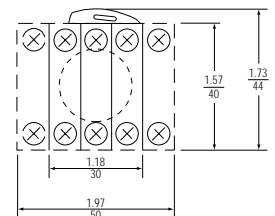

Typical Back Side View

Selection & drawing data: pages 4-5. Accessories: pages 46-47. Technical data: pages 6-11.
 Color caps, heads, lenses and handles are also stocked separately: page 41.



勝特力材料 886-3-5753170
 勝特力电子(上海) 86-21-54151736
 勝特力电子(深圳) 86-755-83298787
 Http://www.100y.com.tw

C-2000™ Push Buttons

4-Position Knob- & Lever-Operated Selector Switches



Selection Process

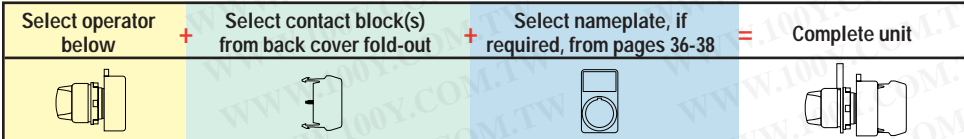

Operators

Replace **asterisk (*)** in catalog number with color code from colors table below.

Style	Handle	Maintained Catalog No.	List Price, GO-10GC	Spring Return R←2R	List Price, GO-10GC
				Catalog No.	
● Polished Chrome	Knob	P9CSMX0*	\$14.50	P9CSMX5*	\$18.50
	Black Lever	P9CSVX0N	14.50	P9CSVX5N	18.50
○ Satin Chrome	Knob	P9MSMX0*	14.50	P9MSMX5*	18.50
	Black Lever	P9MSVX0N	14.50	P9MSVX5N	18.50
● Round Engineered Plastic	Knob	P9XSMX0*	14.50	P9XSMX5*	18.50
	Black Lever	P9XSVX0N	14.50	P9XSVX5N	18.50
□ Square Engineered Plastic	Knob	P9SSMX0*	14.50	P9SSMX5*	18.50

Cams

Note selection and position of contact block(s).

Cam Code					Screw Terminal Contact Block	
	Position 1	Position 2	Position 1	Position 2	Position 1	Position 2
X	0	X	0	0	P9B11VN	—
	0	0	0	X		
	0	0	X	0	—	P9B11VN
	X	0	0	0		

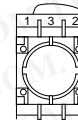

* Colors

Color	Black	Red	Green	Yellow	Blue	No Knob ¹
*Color Code	N	R	V	G	L	0

¹ Subtract \$3.00 from list price, GO-10GC, for selector switches ordered without knobs.

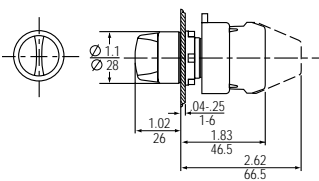

Round Knob Selector Switch

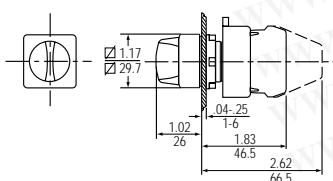

Square Knob Selector Switch

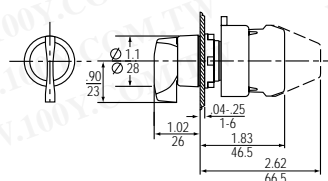

Round Lever Selector Switch

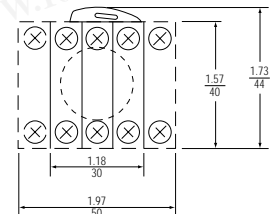

Typical Back Side View

Dimensions shown in inches / millimeters

Selection & drawing data: pages 4-5. Accessories: pages 46-47. Technical data: pages 6-11. Color caps, heads, lenses and handles are also stocked separately: page 41.

5-Position Knob- & Lever-Operated Selector Switches



Selection Process

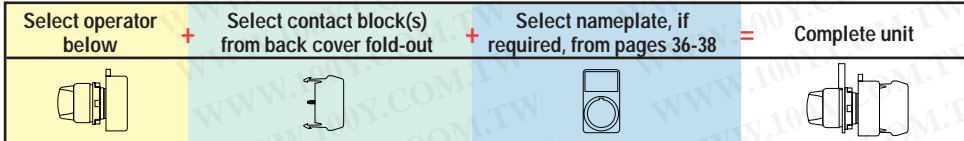

Operators

Replace **asterisk (*)** in catalog number with cam code from cams table below.
 Replace **dagger (†)** in catalog number with color code from colors table below.

Style	Handle	Maintained	List Price, GO-10GC
		Catalog No.	
● Polished Chrome	Knob	P9CSM*0†	\$26.00
	Black Lever	P9CSV*0N	26.00
○ Satin Chrome	Knob	P9MSM*0†	26.00
	Black Lever	P9MSV*0N	26.00
● Round Engineered Plastic	Knob	P9XSM*0†	26.00
	Black Lever	P9XSV*0N	26.00
□ Square Engineered Plastic	Knob	P9SSM*0†	26.00

* Cams

Choose desired cam. Note selection and position of contact block(s).

*Cam Code						Screw Terminal Contact Block	
						Position 1	Position 2
W	0	X	O	O	O	P9B11VN	—
	0	O	O	X	O	—	P9B11VN
	0	O	X	O	O	P9B11VN	—
Y	0	X	O	O	O	P9B11VN	—
	0	O	O	O	X	—	P9B11VN
	X	O	O	O	O	P9B11VN	—

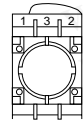

† Colors

Color	Black	Red	Green	Yellow	Blue	No Knob ¹
†Color Code	N	R	V	G	L	0

¹ Subtract \$3.00 from list price, GO-10GC, for selector switches ordered without knobs.

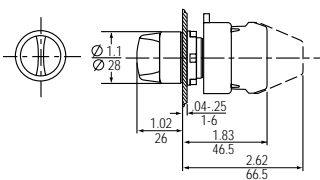

Round Knob Selector Switch

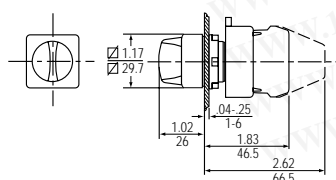

Square Knob Selector Switch

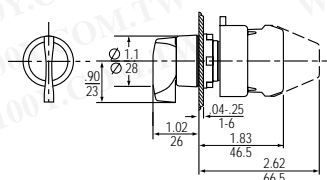

Round Lever Selector Switch

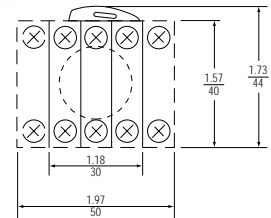

Typical Back Side View

Dimensions shown in $\frac{\text{inches}}{\text{millimeters}}$



勝特力材料 886-3-5753170
 勝特力电子(上海) 86-21-54151736
 勝特力电子(深圳) 86-755-83298787
 Http://www.100y.com.tw

C-2000™ Push Buttons

2- & 3-Position Illuminated Knob-Operated Selector Switches



Selection Process

Select operator below	+	Select power supply from back cover fold-out	+	Select contact block from back cover fold-out	+	Select nameplate, if required, from pages 36-38	=	Complete unit

Operators

Replace **asterisk (*)** in catalog number with color code from colors table below.

Style	Number Of Positions	Maintained Catalog No.	List Price, GO-10GC	Spring Return Catalog Number			List Price, GO-10GC
				L→C	C←R	L→C←R	
● Polished Chrome	2	P9CSLD0*	\$18.50	—	—	—	—
	3	P9CSLZ0*	18.50	P9CSLZ1*	P9CSLZ5*	P9CSLZ3*	\$26.00
○ Satin Chrome	2	P9MSLD0*	18.50	—	—	—	—
	3	P9MSLZ0*	18.50	P9MSLZ1*	P9MSLZ5*	P9MSLZ3*	26.00
● Round Engineered Plastic	2	P9XSLD0*	18.50	—	—	—	—
	3	P9XSLZ0*	18.50	P9XSLZ1*	P9XSLZ5*	P9XSLZ3*	26.00
□ Square Engineered Plastic	2	P9SSLD0*	18.50	—	—	—	—
	3	P9SSLZ0*	18.50	P9SSLZ1*	P9SSLZ5*	P9SSLZ3*	26.00

* Colors

Color	Red	Green	Yellow	Blue	White	Orange	Clear	No Knob ¹
*Color Code	R	V	G	L	B	A	I	0

¹ When ordering operator with no lens, deduct \$3.00 from list price GO-10GC.

Cams

Note selection and position of contact block(s) according to operator type.

2-Position

Cam Code				Screw Terminal Contact Block		Quick Connect Terminal Contact Block	
				Position 1	Position 2	Position 1	Position 2
D	O	—	X	—	P9B10VN	—	P9B10FN
	X	—	O	P9B01VN	—	P9B01FN	—
	O	—	X	P9B11VN	—	—	—
	X	—	O	—	—	—	—

3-Position

Cam Code				Screw Terminal Contact Block		Quick Connect Terminal Contact Block	
				Position 1	Position 2	Position 1	Position 2
Z	O	O	X	P9B10VN	—	P9B10FN	—
	X	O	O	—	P9B10VN	—	P9B10FN
	X	X	O	P9B01VN	—	P9B01FN	—
	O	X	X	—	P9B01VN	—	P9B01FN
	O	O	X	P9B11VN	—	—	—
	X	X	O	—	—	—	—
	X	O	O	—	P9B11VN	—	—

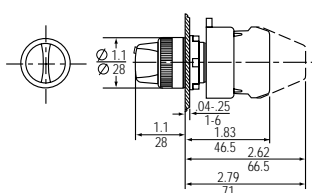
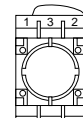
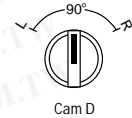

Round Illuminated Knob Selector Switch

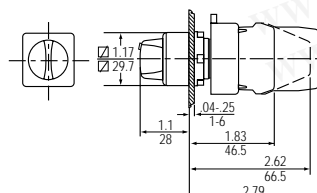

Square Illuminated Knob Selector Switch

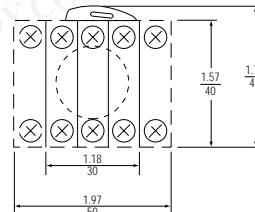

Typical Back Side View

Dimensions shown in $\frac{\text{inches}}{\text{millimeters}}$

Selection & drawing data: pages 4-5. Accessories: pages 46-47. Technical data: pages 6-11. Color caps, heads, lenses and handles are also stocked separately: page 41.

2-Position Key Selector Switches



Selection Process

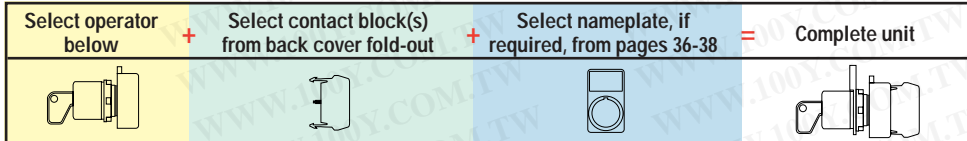

Operators

Replace **asterisk (*)** in catalog number with style code from styles table below.
 Replace **dagger (†)** in catalog number with key code from keys table below.

Cam	Key Removal	Maintained		Spring Return		List Price, GO-10GC
		Catalog No.	List Price, GO-10GC	Catalog No.	List Price, GO-10GC	
D	L	P9*SCD0A†	\$43.50	—	P9*SCD5A†	\$56.50
	R	P9*SCD0E†	43.50	—	—	—
	L-R	P9*SCD0K†	43.50	—	—	—
I	C	P9*SCIOC†	43.50	—	P9*SCI5C†	56.50
	R	P9*SCIOE†	43.50	—	—	—
	C-R	P9*SCION†	43.50	—	—	—
H	L	P9*SCHOA†	43.50	—	—	—
	C	P9*SCHOC†	43.50	P9*SCH1C†	—	56.50
	L-C	P9*SCHOH†	43.50	—	—	—

* Styles

Style	<input type="radio"/> Polished Chrome	<input type="radio"/> Satin Chrome	<input checked="" type="radio"/> Round Engineered Plastic	<input type="checkbox"/> Square Engineered Plastic
*Style Code	C	M	X	S

† Keys (Set Of 2)

Key Number	Std.		Special ¹									Colored ¹				
	3095	9901	9902	9903	9904	9905	9910	9916	9919	3353	R455 (Ronis)	73033 (Yellow)	73034 (Black)	73037 (Red)	73038 (Blue)	73040 (Orange)
†Key Code	95	01	02	03	04	05	10	16	19	53	55	33	34	37	38	40

¹ To order with other than standard key code (95), add \$4.00 to list price, GO-10GC. Minimum quantity order on Key Codes 95, 55 and 33 is one; for all others, minimum quantity order is ten.

Cams

Note position of contact block(s) for cam selected.

Cam Code				Screw Terminal Contact Block		Quick Connect Terminal Contact Block	
				Position 1	Position 2	Position 1	Position 2
D	O	—	X	—	P9B10VN	—	P9B10FN
	X	—	O	P9B01VN	—	P9B01FN	—
	O	—	X	P9B11VN	—	—	—
	X	—	O	—	—	—	—
I	—	O	X	—	P9B10VN	—	P9B10FN
	—	X	O	P9B01VN	—	P9B01FN	—
	—	O	X	P9B11VN	—	—	—
	—	X	O	—	—	—	—
H	X	O	—	—	P9V10VN	—	P9B10FN
	O	X	—	P9B01VN	—	P9B01FN	—
	X	O	—	P9B11VN	—	—	—
	O	X	—	—	—	—	—

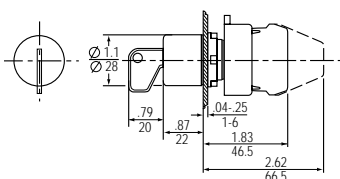
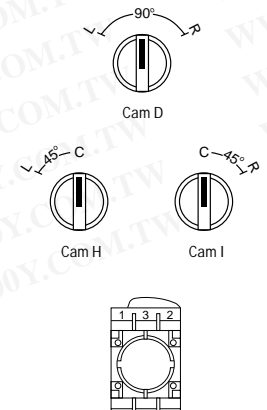

Round Key Selector Switch

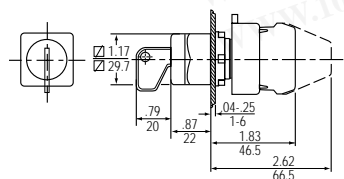

Square Key Selector Switch

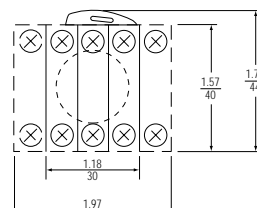

Typical Back Side View

Dimensions shown in inches / millimeters



勝特力材料 886-3-5753170
 勝特力电子(上海) 86-21-54151736
 勝特力电子(深圳) 86-755-83298787
 Http://www.100y.com.tw

C-2000™ Push Buttons

3-Position Key Selector Switches



Selection Process

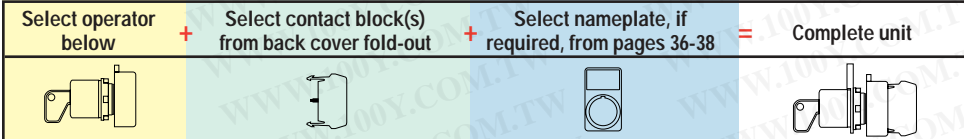

Operators

Replace **asterisk (*)** in catalog number with style code from styles table below.
 Replace **dagger (†)** in catalog number with key code from keys table below.

Cam	Key Removal	Maintained		Spring Return			List Price, GO-10GC
		Catalog No.	List Price, GO-10GC	Catalog No.			
				L⇒C	C⇐R	L⇒C⇐R	
Z	L	P9*SCZ0A†	\$43.50	—	P9*SCZ5A†	—	\$56.50
	C	P9*SCZ0C†	43.50	P9*SCZ1C†	P9*SCZ5C†	P9*SCZ3C†	56.50
	R	P9*SCZ0E†	43.50	P9*SCZ1E†	—	—	56.50
	L-C	P9*SCZ0H†	43.50	—	P9*SCZ5H†	—	56.50
	L-R	P9*SCZ0K†	43.50	—	—	—	—
	C-R	P9*SCZ0N†	43.50	P9*SCZ1N†	—	—	56.50
	L-C-R	P9*SCZ0T†	43.50	—	—	—	—
E	L	P9*SCE0A†	43.50	—	P9*SCE5A†	—	56.50
	C	P9*SCE0C†	43.50	P9*SCE1C†	P9*SCE5C†	P9*SCE3C†	56.50
	R	P9*SCE0E†	43.50	P9*SCE1E†	—	—	56.50
	L-C	P9*SCE0H†	43.50	—	P9*SCE5H†	—	56.50
	L-R	P9*SCE0K†	43.50	—	—	—	—
	C-R	P9*SCE0N†	43.50	P9*SCE1N†	—	—	56.50
	L-C-R	P9*SCE0T†	43.50	—	—	—	—
L	L	P9*SCLOA†	43.50	—	P9*SCL5A†	—	56.50
	C	P9*SCLOC†	43.50	P9*SCL1C†	P9*SCL5C†	P9*SCL3C†	56.50
	R	P9*SCLOE†	43.50	P9*SCL1E†	—	—	56.50
	L-C	P9*SCLOH†	43.50	—	P9*SCL5H†	—	56.50
	L-R	P9*SCLOK†	43.50	—	—	—	—
	C-R	P9*SCLON†	43.50	P9*SCL1N†	—	—	56.50
	L-C-R	P9*SCLOT†	43.50	—	—	—	—
U	L	P9*SCU0A†	43.50	—	P9*SCU5A†	—	56.50
	C	P9*SCU0C†	43.50	P9*SCU1C†	P9*SCU5C†	P9*SCU3C†	56.50
	R	P9*SCU0E†	43.50	P9*SCU1E†	—	—	56.50
	L-C	P9*SCU0H†	43.50	—	P9*SCU5H†	—	56.50
	L-R	P9*SCU0K†	43.50	—	—	—	—
	C-R	P9*SCU0N†	43.50	P9*SCU1N†	—	—	56.50
	L-C-R	P9*SCU0T†	43.50	—	—	—	—

* Styles

Style	<input checked="" type="radio"/> Polished Chrome	<input type="radio"/> Satin Chrome	<input checked="" type="radio"/> Round Engineered Plastic	<input type="checkbox"/> Square Engineered Plastic
*Style Code	C	M	X	S

† Keys (Set Of 2)

Key Number	Std.	Special ¹										Colored ¹				
	3095	9901	9902	9903	9904	9905	9910	9916	9919	3353	R455 (Ronis)	73033 (Yellow)	73034 (Black)	73037 (Red)	73038 (Blue)	73040 (Orange)
†Key Code	95	01	02	03	04	05	10	16	19	53	55	33	34	37	38	40

¹ To order with other than standard key code (95), add \$4.00 to list price, GO-10GC. Minimum quantity order on Key Codes 95, 55 and 33 is one; for all others, minimum quantity order is ten.

3-Position Key Selector Switches

Cams

Note selection and position of contact block(s) for cam selected.

Cam Code				Screw Terminal Contact Block		Quick Connect Terminal Contact Block	
				Position 1	Position 2	Position 1	Position 2
Z	O	O	X	P9B10VN	—	P9B10FN	—
	X	O	O	—	P9B10VN	—	P9B10FN
	X	X	O	P9B01VN	—	P9B01FN	—
	O	X	X	—	P9B01VN	—	P9B01FN
	O	O	X	P9B11VN	—	—	—
	X	X	O	—	P9B11VN	—	—
E	O	O	X	—	P9B01VN	—	P9B01FN
	O	X	O	P9B10VN	—	P9B10FN	—
	O	O	X	P9B11VN	—	—	—
L	X	O	O	—	P9B10VN	—	P9B10FN
	O	X	O	P9B01VN	—	P9B01FN	—
	X	O	O	P9B11VN	—	—	—
U	O	O	X	P9B11VN	—	—	—
	O	X	O	—	P9B11VN	—	—
	X	O	O	—	P9B11VN	—	—

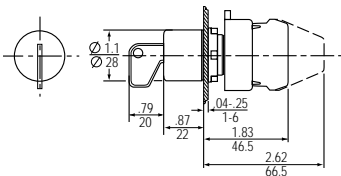
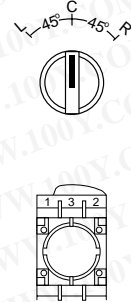

Round Key Selector Switch

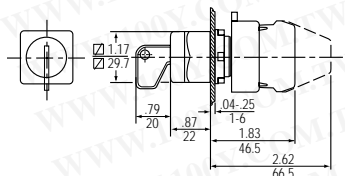

Square Key Selector Switch

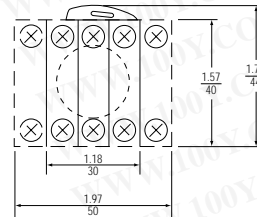

Typical Back Side View

Dimensions shown in $\frac{\text{inches}}{\text{millimeters}}$



勝特力材料 886-3-5753170
 勝特力电子(上海) 86-21-54151736
 勝特力电子(深圳) 86-755-83298787
 Http://www.100y.com.tw

C-2000™ Push Buttons

4-Position Key Selector Switches



Selection Process

Select operator below	+	Select contact block(s) from back cover fold-out	+	Select nameplate, if required, from pages 36-38	=	Complete unit

Operators

Replace **asterisk (*)** in catalog number with style code from styles table below.
 Replace **dagger (†)** in catalog number with key code from keys table below.

Cam	Key Removal	Maintained		Spring Return 2R⇒R	
		Catalog No.	List Price, GO-10GC	Catalog No.	List Price, GO-10GC
X	2L	P9*SCX0A†	\$53.00	P9*SCX5A†	\$66.00
	L	P9*SCX0B†	53.00	P9*SCX5B†	66.00
	R	P9*SCX0D†	53.00	P9*SCX5D†	66.00
	2R	P9*SCX0E†	53.00	—	—
	2L-L	P9*SCX0F†	53.00	P9*SCX5F†	—
	2L-R	P9*SCX0J†	53.00	P9*SCX5J†	66.00
	2L-2R	P9*SCX0K†	53.00	—	—
	L-R	P9*SCX0L†	53.00	P9*SCX5L†	66.00
	L-2R	P9*SCX0M†	53.00	—	—
	R-2R	P9*SCX0P†	53.00	—	—
	2L-L-R	P9*SCX0R†	53.00	P9*SCX5R†	66.00
	2L-L-2R	P9*SCX0S†	53.00	—	—
	2L-R-2R	P9*SCX0U†	53.00	—	—
	L-R-2R	P9*SCX0V†	53.00	—	—
2L-L-R-2R	P9*SCX0Z†	53.00	—	—	

* Styles

Style	<input checked="" type="radio"/> Polished Chrome	<input type="radio"/> Satin Chrome	<input checked="" type="radio"/> Round Engineered Plastic	<input type="checkbox"/> Square Engineered Plastic
* Style Code	C	M	X	S

† Keys (Set Of 2)

Key Number	Std.	Special ¹										Colored ¹				
	3095	9901	9902	9903	9904	9905	9910	9916	9919	3353	R455 (Ronis)	73033 (Yellow)	73034 (Black)	73037 (Red)	73038 (Blue)	73040 (Orange)
† Key Code	95	01	02	03	04	05	10	16	19	53	55	33	34	37	38	40

¹ To order with other than standard key code (95), add \$4.00 to list price, GO-10GC. Minimum quantity order on Key Codes 95, 55 and 33 is one; for all others, minimum quantity order is ten.

Cam

Note selection and position of contact block(s).

Cam Code					Screw Terminal Contact Block	
					Position 1	Position 2
X	0	X	0	0	P9B11VN	—
	0	0	0	X	—	—
	0	0	X	0	—	P9B11VN
	X	0	0	0	—	—

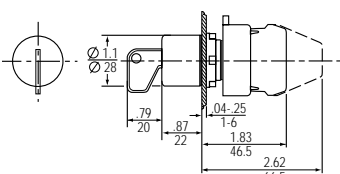
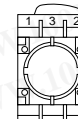
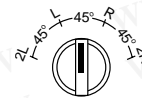

Round Key Selector Switch

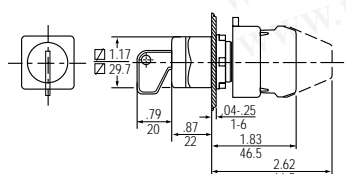

Square Key Selector Switch

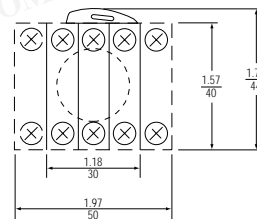

Typical Back Side View

Dimensions shown in inches / millimeters

Selection & drawing data: pages 4-5. Accessories: pages 46-47. Technical data: pages 6-11.

勝特力材料 886-3-5753170
 勝特力电子(上海) 86-21-54151736
 勝特力电子(深圳) 86-755-83298787
[Http://www.100y.com.tw](http://www.100y.com.tw)

C-2000™ Push Buttons

Special Operators

Joysticks, Toggle Switches, Wobble Sticks, Potentiometer Operators, Reset Push Buttons & Buzzers



Selection Process

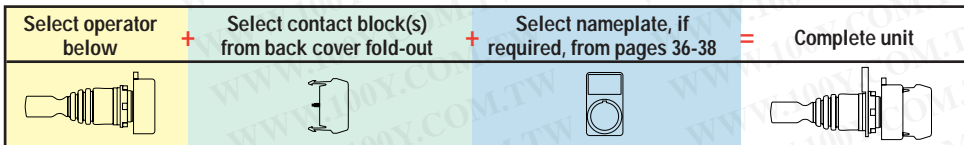

Operators

Joysticks

Style	Positions	Mechanical Interlock	Maintained All Positions	Momentary All Positions	Up Momentary-Down Maintained	Up Maintained-Down Momentary	List Price, GO-10GC
● Polished Chrome	3	No	P9CMN2F	P9CMN2T	P9CMN2A	P9CMN2B	\$85.00
	3	Yes	P9CMB2F	P9CMB2T	P9CMB2A	P9CMB2B	85.00
	5	No	P9CMN4F	P9CMN4T	—	—	115.00
	5	Yes	P9CMB4F	P9CMB4T	—	—	115.00
○ Satin Chrome	3	No	P9MMN2F	P9MMN2T	P9MMN2A	P9MMN2B	85.00
	3	Yes	P9MMB2F	P9MMB2T	P9MMB2A	P9MMB2B	85.00
	5	No	P9MMN4F	P9MMN4T	—	—	115.00
	5	Yes	P9MMB4F	P9MMB4T	—	—	115.00
● Round Engineered Plastic	3	No	P9XMN2F	P9XMN2T	P9XMN2A	P9XMN2B	85.00
	3	Yes	P9XMB2F	P9XMB2T	P9XMB2A	P9XMB2B	85.00
	5	No	P9XMN4F	P9XMN4T	—	—	115.00
	5	Yes	P9XMB4F	P9XMB4T	—	—	115.00

Cams

Note selection and position of contact block(s).

3-Position Joystick

	Position			Screw Terminal Contact Block Catalog No. and Mounting Position	
	Up	Center	Down	Position 1	Position 2
	X	O	O	P9B11VN	—
O	O	X	—	P9B11VN	
O	O	O	—	—	

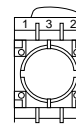

5-Position Joystick

	Position					Screw Terminal Contact Block Catalog No. and Mounting Position	
	Up	Right	Center	Down	Left	Position 1	Position 2
	O	X	O	O	O	P9B11VN	—
O	O	O	O	X	—	P9B11VN	
O	O	O	X	O	—	—	
X	O	O	O	O	—	—	

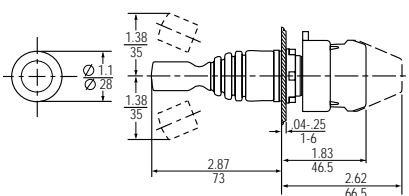

Round Joystick

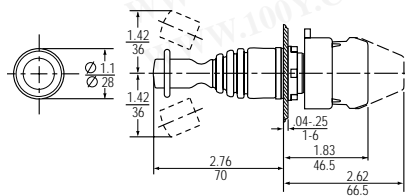

Round Joystick With Interlock

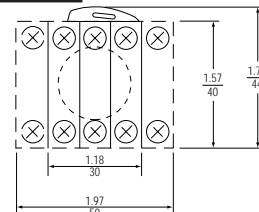

Typical Back Side View

Dimensions shown in inches / millimeters

Selection & drawing data: pages 4-5. Accessories: pages 46-47. Technical data: pages 6-11.



勝特力材料 886-3-5753170
 勝特力电子(上海) 86-21-54151736
 勝特力电子(深圳) 86-755-83298787
 Http://www.100y.com.tw

C-2000™ Push Buttons

Special Operators

Toggle Switches

Style	2 Positions Maintained	3 Positions Maintained	List Price, GO-10GC	3 Positions, Spring Return From Top	List Price, GO-10GC
<input checked="" type="radio"/> Polished Chrome	P9CCD	P9CCB	\$15.50	P9CCC	\$18.50
<input type="radio"/> Satin Chrome	P9MCD	P9MCB	15.50	P9MCC	18.50
<input checked="" type="radio"/> Round Engineered Plastic	P9XCD	P9XCB	15.50	P9XCC	18.50
<input type="checkbox"/> Square Engineered Plastic	P9SCD	P9SCB	15.50	P9SCC	18.50

Cams

Note selection and position of contact block(s) for cam.

Positions	Up	Center	Down	Contact Block Mounting Position			
				Screw Terminal Catalog No.		Quick Connect Terminal Catalog No.	
				1	2	1	2
2	X	—	0	—	P9B10VN	—	P9B10FN
	0	—	X	P9B01VN	—	P9B01FN	—
	X	—	0	P9B11VN	—	—	—
	0	—	X	—	—	—	—
3	X	0	0	—	P9B10VN	—	P9B10FN
	0	0	X	P9B01VN	—	P9B01FN	—
	X	0	0	P9B11VN	—	—	—
	0	0	X	—	—	—	—

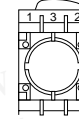

Wobble Sticks

Style	Catalog No.	List Price, GO-10GC
<input checked="" type="radio"/> Polished Chrome	P9CWR	\$31.00
<input type="radio"/> Satin Chrome	P9MWR	31.00
<input checked="" type="radio"/> Round Engineered Plastic	P9XWR	31.00

Potentiometer Operators

Style	Catalog No.	List Price, GO-10GC
<input checked="" type="radio"/> Polished Chrome	P9CZ	\$65.00
<input type="radio"/> Satin Chrome	P9MZ	65.00
<input checked="" type="radio"/> Round Engineered Plastic	P9XZ	65.00
<input type="checkbox"/> Square Engineered Plastic	P9SZ	65.00

Reset Push Buttons

(Flush blue push buttons with white "R" provided with screw adjustable from 60mm to 80mm depth)

Style	Catalog No.	List Price, GO-10GC
<input checked="" type="radio"/> Polished Chrome	P9CRG	\$12.50
<input type="radio"/> Satin Chrome	P9MRG	12.50
<input checked="" type="radio"/> Round Engineered Plastic	P9XRG	12.50
<input type="checkbox"/> Square Engineered Plastic	P9SRG	12.50

Extended Screw For All Reset Push Buttons

(Adjustable from 80mm to 170mm depth)

Style	Catalog No.	List Price, GO-10GC
<input checked="" type="radio"/> <input type="radio"/> <input checked="" type="radio"/> <input type="checkbox"/>	P9ACVLR	\$4.50

Buzzer (Piezoelectric Transducer)

(85 dB @ 1 meter output)

Style	Voltage	Catalog No.	List Price, GO-10GC
<input checked="" type="radio"/> Round Engineered Plastic	24V AC/DC	P9XBD	\$65.00
	110-240V AC/DC	P9XBM	65.00
<input type="checkbox"/> Square Engineered Plastic	24V AC/DC	P9SBD	65.00
	110-240V AC/DC	P9SBM	65.00

Selection & drawing data: pages 4-5. Accessories: pages 46-47. Technical data: pages 6-11.

Special Operators

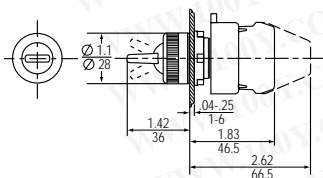

Round Toggle Switch

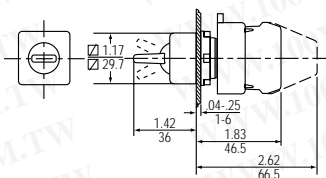

Square Toggle Switch

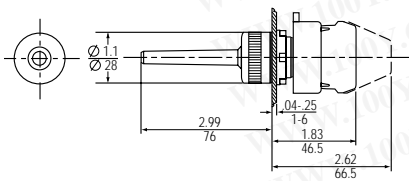

Round Wobble Stick

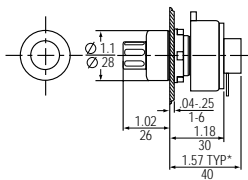

*Potentiometer supplied by customer

Round Potentiometer Operator

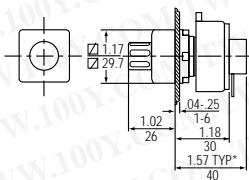

*Potentiometer supplied by customer

Square Potentiometer Operator

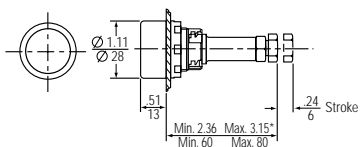

* Min. 3.15 Max. 6.69 With Accessory P9ACVLR
Min. 80 Max. 170

Round Reset Push Button

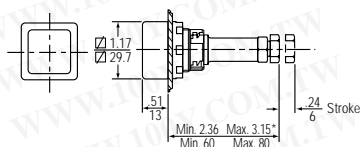

* Min. 3.15 Max. 6.69 With Accessory P9ACVLR
Min. 80 Max. 170

Square Reset Push Button

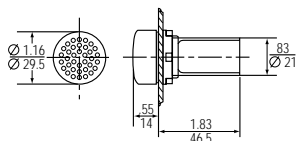

Round Buzzer

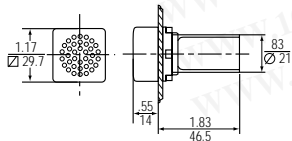

Square Buzzer

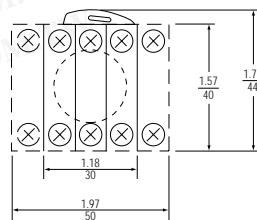

Typical Back Side View

Dimensions shown in inches
millimeters



勝特力材料 886-3-5753170
 勝特力电子(上海) 86-21-54151736
 勝特力电子(深圳) 86-755-83298787
[Http://www.100y.com.tw](http://www.100y.com.tw)

C-2000™ Push Buttons

Multi-Function Push Buttons



Selection Process

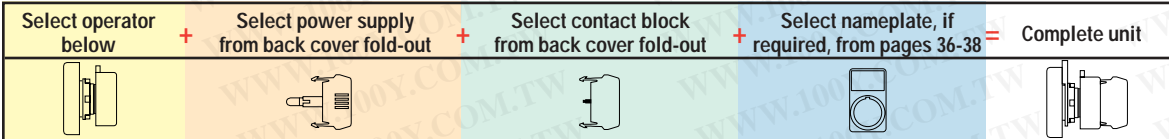

NEMA 1 Operators

Color	Type	Marking	Illuminated & Non-illuminated	
			Catalog No.	List Price, GO-10GC
Black Top, Red Bottom	Flush	None	P9DPLNRG00	\$21.50
		Top - I Bottom-0	P9DPLNRG01	21.50
	Flush Top, Extended Bottom	None	P9DPLNRS00	21.50
		Top - I Bottom-0	P9DPLNRS01	21.50
Green Top, Red Bottom	Flush	None	P9DPLVRG00	21.50
		Top - I Bottom-0	P9DPLVRG01	21.50
	Flush Top, Extended Bottom	None	P9DPLVRS00	21.50
		Top - I Bottom-0	P9DPLVRS01	21.50

Rubber boot for conversion of multi-function push buttons (flush type only) to NEMA 3, 3R, 3S, 4, 4X, 12 & 13 and IP66

Description	Catalog No.	List Price, GO-10GC
Silicone rubber boot for use with flush operators	080CPDT	\$5.00

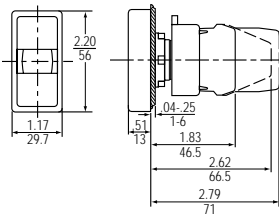

Double Push Button
(Top & Bottom Flush)

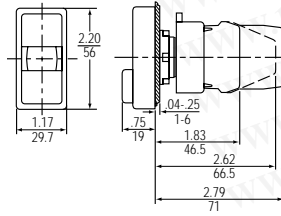

Double Push Button
(Top Flush & Bottom Extended)

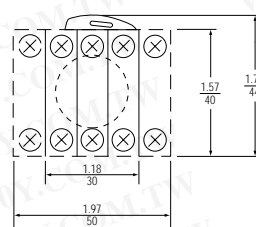

Typical Back Side View

Dimensions shown in inches
millimeters

Key-Operated & Selector Push Buttons



Operators

Key Push Buttons

Replace **asterisk (*)** in catalog number with key code digits from keys table below.

Style	Key Removal	Lockable Position			List Price, GO-10GC
		Normal	Depressed	Normal & Depressed	
● Polished Chrome	R	P9CPCN1E*	P9CPCN2E*	P9CPCN3E*	\$50.50
	L-R	P9CPCN1K*	P9CPCN2K*	P9CPCN3K*	50.50
○ Satin Chrome	R	P9MPCN1E*	P9MPCN2E*	P9MPCN3E*	50.50
	L-R	P9MPCN1K*	P9MPCN2K*	P9MPCN3K*	50.50
● Round Engineered Plastic	R	P9XPCN1E*	P9XPCN2E*	P9XPCN3E*	50.50
	L-R	P9XPCN1K*	P9XPCN2K*	P9XPCN3K*	50.50

* Keys (Set Of 2)

Key Number	Std.	Special ¹										Colored ¹				
	3095	9901	9902	9903	9904	9905	9910	9916	9919	3353	R455 (Ronis)	73033 (Yellow)	73034 (Black)	73037 (Red)	73038 (Blue)	73040 (Orange)
*Key Code	95	01	02	03	04	05	10	16	19	53	55	33	34	37	38	40

¹ To order with other than standard key code (95), add \$4.00 to list price, GO-10GC. Minimum quantity order on Key Codes 95, 55 and 33 is one; for all others, minimum quantity order is ten.

Selector Push Buttons

Replace **asterisk (*)** in catalog number with cam code digits from cams table below.

Style	Catalog No.	List Price, GO-10GC
● Polished Chrome	P9CPS*G	\$26.50
○ Satin Chrome	P9MPS*G	26.50

* Cams

Cam	201	231	235	301	323
*Cam Code	21	22	23	34	35

Cams

Note selection and position of contact block(s) for cam.

Positions	Cam Code	Selector Position						Screw Terminal Contact Block	
		Left		Center		Right		Position 1	Position 2
		Out	In	Out	In	Out	In		
2	21	0	0	—	—	0	X	P9B11VN	—
		X	X	—	—	X	0	—	P9B11VN
		0	X	—	—	0	X	P9B11VN	—
	22	X	0	—	—	X	0	—	P9B11VN
		0	0	—	—	0	X	P9B11VN	—
		X	X	—	—	0	0	—	P9B11VN
23	0	X	—	—	0	↑	P9B11VN	—	
	X	0	—	—	X	N/A ^①	—	P9B11VN	
	0	0	—	—	0	↓	—	P9B11VN	
3	34	0	0	0	X	0	X	P9B11VN	—
		X	X	X	0	X	0	—	P9B11VN
		0	X	0	X	0	0	—	P9B11VN
	35	X	0	0	0	0	X	P9B11VN	—
		0	X	0	0	0	0	—	P9B11VN
		0	0	0	0	X	X	—	P9B11VN

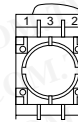

^① This cam cannot be depressed in this position.

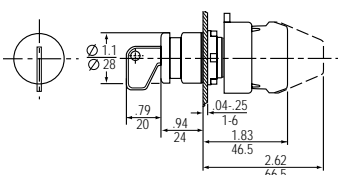

Round Key Push Button

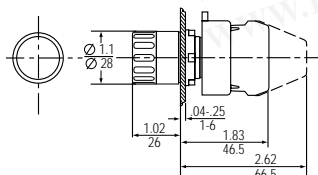

Round Selector Push Button

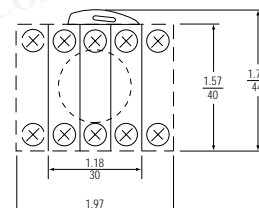

Typical Back Side View

Dimensions shown in inches / millimeters



勝特力材料 886-3-5753170
 勝特力电子(上海) 86-21-54151736
 勝特力电子(深圳) 86-755-83298787
[Http://www.100y.com.tw](http://www.100y.com.tw)

C-2000™ Push Buttons

Nameplates



Standard Markings

Metal Nameplates And Inserts For Standard Size Plastic Nameplate Holders

Marking	Metal Nameplate Catalog No.	List Price, GO-10GC	Plastic Insert Catalog No. ¹	List Price, GO-10GC
Auto	P9ACP2N219	\$1.80	P9ACPBS219	\$.50
Auto Cut	P9ACP2N272	1.80	P9ACPBS272	.50
Auto Return	P9ACP2N273	1.80	P9ACPBS273	.50
Close	P9ACP2N205	1.80	P9ACPBS205	.50
Control Off	P9ACP2N262	1.80	P9ACPBS262	.50
Control On	P9ACP2N286	1.80	P9ACPBS286	.50
Cycle On	P9ACP2N266	1.80	P9ACPBS266	.50
Decrease	P9ACP2N274	1.80	P9ACPBS274	.50
Down	P9ACP2N203	1.80	P9ACPBS203	.50
Emergency Stop (RED)	P9ACP2R229	1.80	P9ACPBS229	.50
Emergency Stop Pull to Reset (RED)	P9ACP2R230	1.80	P9ACPBS230	.50
Fast	P9ACP2N208	1.80	P9ACPBS208	.50
Fault	P9ACP2N218	1.80	P9ACPBS218	.50
Forward	P9ACP2N214	1.80	P9ACPBS214	.50
Hand	P9ACP2N220	1.80	P9ACPBS220	.50
High	P9ACP2N221	1.80	P9ACPBS221	.50
In	P9ACP2N275	1.80	P9ACPBS275	.50
Inch	P9ACP2N209	1.80	P9ACPBS209	.50
Increase	P9ACP2N278	1.80	P9ACPBS278	.50
Jog	P9ACP2N210	1.80	P9ACPBS210	.50
Left	P9ACP2N222	1.80	P9ACPBS222	.50
Low	P9ACP2N223	1.80	P9ACPBS223	.50
Lower	P9ACP2N217	1.80	P9ACPBS217	.50
Off (Red)	P9ACP2R213	1.80	P9ACPBS213	.50
On	P9ACP2N212	1.80	P9ACPBS212	.50
Open	P9ACP2N206	1.80	P9ACPBS206	.50
Out	P9ACP2N293	1.80	P9ACPBS293	.50
Overload Tripped	P9ACP2N226	1.80	P9ACPBS226	.50
Power On	P9ACP2N240	1.80	P9ACPBS240	.50
Push to Stop/Pull to Start	P9ACP2N241	1.80	P9ACPBS241	.50
Raise	P9ACP2N216	1.80	P9ACPBS216	.50
Reset	P9ACP2N291	1.80	P9ACPBS291	.50
Return	P9ACP2N242	1.80	P9ACPBS242	.50
Reverse	P9ACP2N215	1.80	P9ACPBS215	.50
Right	P9ACP2N224	1.80	P9ACPBS224	.50
Run	P9ACP2N211	1.80	P9ACPBS211	.50
Safe	P9ACP2N281	1.80	P9ACPBS281	.50
Slow	P9ACP2N207	1.80	P9ACPBS207	.50
Spindle Closed	P9ACP2N294	1.80	P9ACPBS294	.50
Spindle Open	P9ACP2N295	1.80	P9ACPBS295	.50
Start	P9ACP2N202	1.80	P9ACPBS202	.50
Stop (RED)	P9ACP2R201	1.80	P9ACPBS201	.50
Stop Rotate to Reset	P9ACP2N228	1.80	P9ACPBS228	.50
Sub SPD Closed	P9ACP2N296	1.80	P9ACPBS296	.50
Sub SPD Open	P9ACP2N297	1.80	P9ACPBS297	.50
Test	P9ACP2N225	1.80	P9ACPBS225	.50
Up	P9ACP2N204	1.80	P9ACPBS204	.50
Feed Hold	P9ACP2N263	1.80	P9ACPBS263	.50
For Rev	P9ACP2N231	1.80	P9ACPBS231	.50
Hand Auto	P9ACP2N243	1.80	P9ACPBS243	.50
High Low	P9ACP2N244	1.80	P9ACPBS244	.50
H.P. Coolant	P9ACP2N290	1.80	P9ACPBS290	.50

¹ For use with plastic nameplate holders on page 38.

勝特力材料 886-3-5753170
 勝特力电子(上海) 86-21-54151736
 勝特力电子(深圳) 86-755-83298787
[Http://www.100y.com.tw](http://www.100y.com.tw)

C-2000™ Push Buttons

Nameplates

Standard Markings

Metal Nameplates And Inserts For Standard Size Plastic Nameplate Holders

Marking	Metal Nameplate Catalog No.	List Price, GO-10GC	Plastic Insert Catalog No. ¹	List Price, GO-10GC
Inch Cut	P9ACP2N276	1.80	P9ACPBS276	.50
Inch Return	P9ACP2N277	1.80	P9ACPBS277	.50
Jog Forward	P9ACP2N279	1.80	P9ACPBS279	.50
Jog Reverse	P9ACP2N280	1.80	P9ACPBS280	.50
Jog Run	P9ACP2N245	1.80	P9ACPBS245	.50
Left Right	P9ACP2N246	1.80	P9ACPBS246	.50
Low High	P9ACP2N247	1.80	P9ACPBS247	.50
Lower Raise	P9ACP2N248	1.80	P9ACPBS248	.50
Off On	P9ACP2N233	1.80	P9ACPBS233	.50
Open Close	P9ACP2N234	1.80	P9ACPBS234	.50
Raise Lower	P9ACP2N249	1.80	P9ACPBS249	.50
Rev For	P9ACP2N250	1.80	P9ACPBS250	.50
Run Jog	P9ACP2N251	1.80	P9ACPBS251	.50
Safe Run	P9ACP2N252	1.80	P9ACPBS252	.50
Slow Fast	P9ACP2N253	1.80	P9ACPBS253	.50
Start Cycle	P9ACP2N282	1.80	P9ACPBS282	.50
Start Feed	P9ACP2N283	1.80	P9ACPBS283	.50
Start Jog	P9ACP2N254	1.80	P9ACPBS254	.50
Start Stop	P9ACP2N255	1.80	P9ACPBS255	.50
Stop Cycle	P9ACP2N265	1.80	P9ACPBS265	.50
Stop Feed	P9ACP2N264	1.80	P9ACPBS264	.50
Stop Reset (Red)	P9ACP2R227	1.80	P9ACPBS227	.50
Stop Start	P9ACP2N232	1.80	P9ACPBS232	.50
Up Down	P9ACP2N256	1.80	P9ACPBS256	.50
Off Coolant On	P9ACP2N257	1.80	P9ACPBS257	.50
Auto Off Hand	P9ACP2N258	1.80	P9ACPBS258	.50
For Off Rev	P9ACP2N239	1.80	P9ACPBS239	.50
For Stop Rev	P9ACP2N259	1.80	P9ACPBS259	.50
Hand Off Auto	P9ACP2N261	1.80	P9ACPBS261	.50
Jog Off Run	P9ACP2N298	1.80	P9ACPBS298	.50
Jog Safe Run	P9ACP2N267	1.80	P9ACPBS267	.50
Local Off Remote	P9ACP2N237	1.80	P9ACPBS237	.50
Low Off High	P9ACP2N238	1.80	P9ACPBS238	.50
Lower Off Raise	P9ACP2N268	1.80	P9ACPBS268	.50
Man Off Auto	P9ACP2N269	1.80	P9ACPBS269	.50
Open Off Close	P9ACP2N270	1.80	P9ACPBS270	.50
Slow Off Fast	P9ACP2N271	1.80	P9ACPBS271	.50
Abrir	—	—	P9ACPBS506	.50
Adelante	—	—	P9ACPBS502	.50
Atras	—	—	P9ACPBS508	.50
Atras Adelante	—	—	P9ACPBS518	.50
Atras O Adelante	—	—	P9ACPBS519	.50
Bajar	—	—	P9ACPBS505	.50
Bajo	—	—	P9ACPBS514	.50
Cerrar	—	—	P9ACPBS501	.50
Defecto	—	—	P9ACPBS513	.50
Derecha	—	—	P9ACPBS509	.50
Emergencia	—	—	P9ACPBS516	.50
Izquierda	—	—	P9ACPBS504	.50
Manual	—	—	P9ACPBS503	.50
Marcha	—	—	P9ACPBS510	.50
Paro (Red)	—	—	P9ACPBS511	.50
Paro Marcha	—	—	P9ACPBS517	.50
Paro O Marcha	—	—	P9ACPBS520	.50
Rapido	—	—	P9ACPBS512	.50
Rearme	—	—	P9ACPBS515	.50
Subir	—	—	P9ACPBS507	.50

¹ For use with plastic nameplate holders on page 38.



勝特力材料 886-3-5753170
勝特力电子(上海) 86-21-54151736
勝特力电子(深圳) 86-755-83298787
[Http://www.100y.com.tw](http://www.100y.com.tw)

C-2000™ Push Buttons

Nameplates

Plastic Nameplates With Blank Inserts

(Includes black holder with black/red reversible insert.)

For Use With	Size	Holder and Insert Catalog No.	List Price, GO-10GC ¹	Spare Blank Insert Catalog No.	List Price, GO-10GC ¹	Transparent Insert Catalog No.	List Price, GO-10GC ¹
<input checked="" type="radio"/> Polished Chrome	Standard	P9ARTBS	\$1.00 each	P9ACPBS	\$.50 each	P9ACPTS	\$.50 each
<input type="radio"/> Satin Chrome		P9ARTBM	1.50 each	P9ARPBM	.50 each	P9ACPTM	.50 each
<input checked="" type="radio"/> Round Engineered Plastic	Jumbo	P9ARTBS	2.00 each	P9ACPBS	.50 each	P9ACPTS	.50 each
<input type="checkbox"/> Square Engineered Plastic	Standard	P9ASTBS	2.00 each	P9ACPBS	.50 each	P9ACPTS	.50 each

¹ Package quantity is five; order in multiples of five.

Plastic Nameplate Holders With Custom Engraved Inserts

For Use With	Size	Catalog No.	List Price, GO-10GC
<input checked="" type="radio"/> Polished Chrome	Standard	P9ARTBSEN	\$8.00
<input type="radio"/> Satin Chrome		P9ARTBMEN	8.00
<input checked="" type="radio"/> Round Engineered Plastic	Jumbo	P9ARTBSEN	8.00
<input type="checkbox"/> Square Engineered Plastic	Standard	P9ASTBSEN	8.00

For custom engraved plastic nameplates, specify Figure corresponding to desired field configuration, characters desired for each field, and color (black or red) of field.

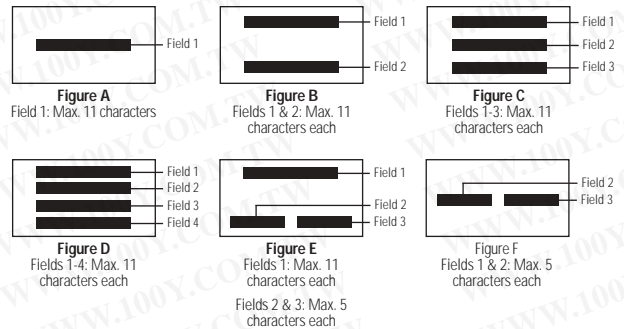

Blank Metal Nameplates

Type	Size	Color	Catalog No.	List Price, GO-10GC
Metal	Standard	Black	P9ACP2N	\$1.80
		Red	P9ACP2R	\$1.80
Metal (Joystick)	Joystick	Black	P9ACP3N	\$1.80
		Red	P9ACP3R	\$1.80

Custom Engraved Metal Nameplates

Figure	Size	Maximum Characters/Field	Black Catalog No.	Red Catalog No.	List Price, GO-10GC
1	Standard	Field 1: 13	P9ACP2NBEN	P9ACP2RBEN	\$8.00
2		Fields 1 & 2: 13 each	P9ACP2NCEN	P9ACP2RCEN	8.00
3		Fields 1 & 2: 6 each	P9ACP2NFEN	P9ACP2RFEN	8.00
4	Standard	Fields 1 & 3: 6 each, Fields 2: 13	P9ACP2NGEN	P9ACP2RGEN	8.00
5		Fields 1-4: 13 each	P9ACP2NHEN	P9ACP2RHEN	8.00
7	Joystick	Fields 1 & 2: 17 each	P9ACP3NJEN	P9ACP3RJEN	8.00
8		Fields 1 & 2: 17 each, Fields 3 & 4: 4 each	P9ACP3NKEN	P9ACP3RKEN	8.00

For custom engraved metal nameplates, specify Figure corresponding to desired field configuration and characters desired for each field.

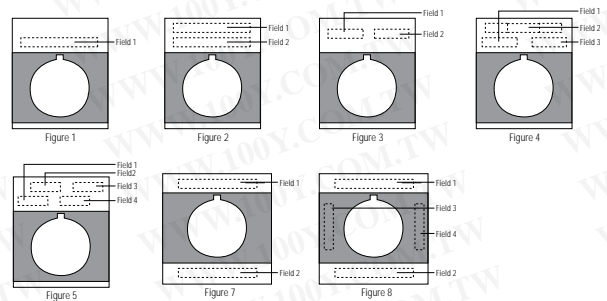

Yellow Emergency Nameplates

Description	Diameter	Catalog No.	List Price, GO-10GC ¹
Blank Round	59mm	080XTGR	\$2.00 each
	78mm	080XTG8	2.00 each
Round Engraved "Emergency Stop"	59mm	080XTGR02	2.00 each
	78mm	080XTG802	2.00 each

¹ Package quantity is five; order in multiples of five.

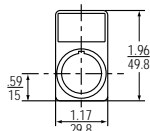
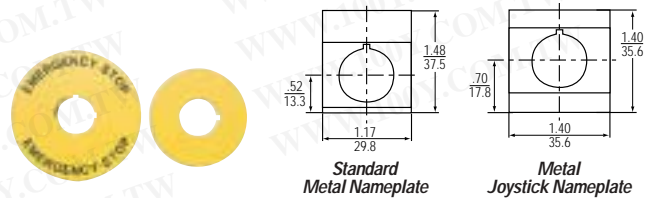

Round Standard Plate Holder

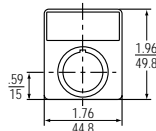

Round Large Plate Holder

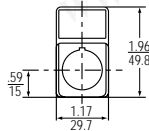

Square Standard Plate Holder

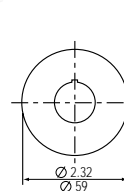

Round Yellow Nameplate (59 mm)

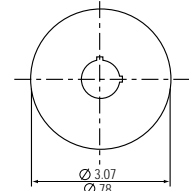

Round Yellow Nameplate (78 mm)

Dimensions shown in inches / millimeters

Specially Marked Push Button Caps

For use with standard push buttons only (see page 15). Order push button without cap and specially marked cap separately.

Meaning	Marking	Color	Catalog No.				List Price, GO-10GC
			Flush, Recessed ¹ ●●●	Extended ●●●	Flush □	Extended □	
Stop		Red	P9ARBGR201	P9ARBSR201	P9ASBGR201	P9ASBSR201	\$3.50
Start		Black	P9ARBGN202	P9ARBSN202	P9ASBGN202	P9ASBSN202	3.50
		Green	P9ARBGV202	P9ARBSV202	P9ASBGV202	P9ASBSV202	3.50
Stop		Red	P9ARBGR029	P9ARBSR029	P9ASBGR029	P9ASBSR029	3.50
Start		Black	P9ARBGN028	P9ARBSN028	P9ASBGN028	P9ASBSN028	3.50
		Green	P9ARBGV028	P9ARBSV028	P9ASBGV028	P9ASBSV028	3.50
2nd Function		Black	P9ARBGN035	P9ARBSN035	P9ASBGN035	P9ASBSN035	3.50
		Green	P9ARBGV035	P9ARBSV035	P9ASBGV035	P9ASBSV035	3.50
3rd Function		Black	P9ARBGN038	P9ARBSN038	P9ASBGN038	P9ASBSN038	3.50
		Green	P9ARBGV038	P9ARBSV038	P9ASBGV038	P9ASBSV038	3.50
Continuous Linear Movement		Black	P9ARBGN006	P9ARBSN006	P9ASBGN006	P9ASBSN006	3.50
		Green	P9ARBGV006	P9ARBSV006	P9ASBGV006	P9ASBSV006	3.50
Continuous Clockwise Rotation		Black	P9ARBGN012	P9ARBSN012	P9ASBGN012	P9ASBSN012	3.50
		Green	P9ARBGV012	P9ARBSV012	P9ASBGV012	P9ASBSV012	3.50
Continuous Counter-clockwise Rotation		Black	P9ARBGN013	P9ARBSN013	P9ASBGN013	P9ASBSN013	3.50
		Green	P9ARBGV013	P9ARBSV013	P9ASBGV013	P9ASBSV013	3.50
Feed		Black	P9ARBGN014	P9ARBSN014	P9ASBGN014	P9ASBSN014	3.50
		Green	P9ARBGV014	P9ARBSV014	P9ASBGV014	P9ASBSV014	3.50
Increase		Black	P9ARBGN017	P9ARBSN017	P9ASBGN017	P9ASBSN017	3.50
		Green	P9ARBGV017	P9ARBSV017	P9ASBGV017	P9ASBSV017	3.50
Decrease		Black	P9ARBGN018	P9ARBSN018	P9ASBGN018	P9ASBSN018	3.50
		Green	P9ARBGV018	P9ARBSV018	P9ASBGV018	P9ASBSV018	3.50
Auto		Black	P9ARBGN026	P9ARBSN026	P9ASBGN026	P9ASBSN026	3.50
		Green	P9ARBGV026	P9ARBSV026	P9ASBGV026	P9ASBSV026	3.50
Hand		Black	P9ARBGN027	P9ARBSN027	P9ASBGN027	P9ASBSN027	3.50
		Green	P9ARBGV027	P9ARBSV027	P9ASBGV027	P9ASBSV027	3.50
Engage		Black	P9ARBGN031	P9ARBSN031	P9ASBGN031	P9ASBSN031	3.50
		Green	P9ARBGV031	P9ARBSV031	P9ASBGV031	P9ASBSV031	3.50
Disengage		Black	P9ARBGN032	P9ARBSN032	P9ASBGN032	P9ASBSN032	3.50
		Green	P9ARBGV032	P9ARBSV032	P9ASBGV032	P9ASBSV032	3.50
Coolant		Black	P9ARBGN001	P9ARBSN001	P9ASBGN001	P9ASBSN001	3.50
		Green	P9ARBGV001	P9ARBSV001	P9ASBGV001	P9ASBSV001	3.50
Light		Black	P9ARBGN002	P9ARBSN002	P9ASBGN002	P9ASBSN002	3.50
		Green	P9ARBGV002	P9ARBSV002	P9ASBGV002	P9ASBSV002	3.50
Lubrication		Black	P9ARBGN005	P9ARBSN005	P9ASBGN005	P9ASBSN005	3.50
		Green	P9ARBGV005	P9ARBSV005	P9ASBGV005	P9ASBSV005	3.50
Reset		Blue	P9ARBGL037	P9ARBSL037	P9ASBGL037	P9ASBSL037	3.50
Stop/Reset		Red	P9ARBGR036	P9ARBSR036	P9ASBGR036	P9ASBSR036	3.50
Impulse Control		Black	P9ARBGN030	P9ARBSN030	P9ASBGN030	P9ASBSN030	3.50
		Green	P9ARBGV030	P9ARBSV030	P9ASBGV030	P9ASBSV030	3.50

¹Caps for engineered plastic push buttons available for flush operators only.

Style Legend

Polished Chrome	Satin Chrome	Round Engineered Plastic	Square Engineered Plastic



勝特力材料 886-3-5753170
 勝特力电子(上海) 86-21-54151736
 勝特力电子(深圳) 86-755-83298787
 Http://www.100y.com.tw

C-2000™ Push Buttons

Specially Marked Diffusers & Inserts For Illuminated Push Buttons & Pilot Lights

For use with illuminated push buttons (see page 16) and diffused pilot lights (see page 20) only. For round operators (polished chrome, satin chrome, round engineered plastic), order operator without lens, specially marked diffuser and lens separately. For square engineered plastic operators, order operator, insert and lens separately. Separate lenses are listed on page 41.

Meaning	Marking	Color	Diffuser Catalog No.		Insert Catalog No.	List Price, GO-10GC
			Pilot Light 	Illuminated Push Button 	Pilot Light & Illuminated Push Button 	
Stop		White	P9ARDLS201	P9ARDPL201	080QDF201	\$1.00
Start		White	P9ARDLS202	P9ARDPL202	080QDF202	1.00
Stop		White	P9ARDLS029	P9ARDPL029	080QDF029	1.00
Start		White	P9ARDLS028	P9ARDPL028	080QDF028	1.00
2nd Function		White	P9ARDLS035	P9ARDPL035	080QDF035	1.00
3rd Function		White	P9ARDLS038	P9ARDPL038	080QDF038	1.00
Continuous Linear Movement		White	P9ARDLS006	P9ARDPL006	080QDF006	1.00
Continuous Clockwise Rotation		White	P9ARDLS012	P9ARDPL012	080QDF012	1.00
Continuous Counter-Clockwise Rotation		White	P9ARDLS013	P9ARDPL013	080QDF013	1.00
Feed		White	P9ARDLS014	P9ARDPL014	080QDF014	1.00
Increase		White	P9ARDLS017	P9ARDPL017	080QDF017	1.00
Decrease		White	P9ARDLS018	P9ARDPL018	080QDF018	1.00
Auto		White	P9ARDLS026	P9ARDPL026	080QDF026	1.00
Hand		White	P9ARDLS027	P9ARDPL027	080QDF027	1.00
Engage		White	P9ARDLS031	P9ARDPL031	080QDF031	1.00
Disengage		White	P9ARDLS032	P9ARDPL032	080QDF032	1.00
Coolant		White	P9ARDLS001	P9ARDPL001	080QDF001	1.00
Light		White	P9ARDLS002	P9ARDPL002	080QDF002	1.00
Lubrication		White	P9ARDLS005	P9ARDPL005	080QDF005	1.00
Impulse Control		White	P9ARDLS030	P9ARDPL030	080QDF030	1.00
Blank Insert		White	—	—	080QDF	1.00

Style Legend

Polished Chrome	Satin Chrome	Round Engineered Plastic	Square Engineered Plastic

Caps, Heads, Lenses & Handles

For Non-illuminated Devices

Item	Style(s)	Catalog No.									List Price, GO-10GC
		Black	Red	Green	Yellow	Brown	Blue	White	Gray	Clear	
Caps for flush & recessed push buttons	●○●	P9ARBGN	P9ARBGR	P9ARBGV	P9ARBGG	P9ARBGM	P9ARBGL	P9ARBGB	P9ARBGH	—	\$1.00
	□	P9ASBGN	P9ASBGR	P9ASBGV	P9ASBGG	P9ASBGM	P9ASBGL	P9ASBGB	P9ASBGH	—	1.00
Caps for extended push buttons	●○●	P9ARBSN	P9ARBSR	P9ARBSV	P9ARBSG	P9ARBSM	P9ARBSL	P9ARBSB	P9ARBSH	—	1.00
	□	P9ASBSN	P9ASBSR	P9ASBSV	P9ASBSG	P9ASBSM	P9ASBSL	P9ASBSB	P9ASBSH	—	1.00
Mushroom heads, 28mm	●○●	P9ARB3N	P9ARB3R	P9ARB3V	P9ARB3G	—	—	—	—	—	7.00
Mushroom heads, 40mm	●○●	P9ARB4N	P9ARB4R	P9ARB4V	P9ARB4G	—	—	—	—	—	7.00
Mushroom heads, 60mm	●○●	P9ARB6N	P9ARB6R	P9ARB6V	P9ARB6G	—	—	—	—	—	9.00
Mushroom heads, 29mm	□	P9ASB3N	P9ASB3R	P9ASB3V	P9ASB3G	—	—	—	—	—	7.00
Heads for push pull mushroom-head push buttons (40mm)	●○●	P9ACB4N	P9ACB4R	P9ACB4V	P9ACB4G	—	—	—	—	—	8.00
	□	—	—	—	—	—	—	—	—	—	—
Knobs	●○●□	P9ACMNN	P9ACMNR	P9ACMNV	P9ACMNG	—	P9ACMNL	—	—	—	3.00
Levers	●○●	P9ARMVN	—	—	—	—	—	—	—	—	3.00
Transparent protective cap for extended push buttons	●○●	—	—	—	—	—	—	—	—	P9ARCST	5.00
	□	—	—	—	—	—	—	—	—	P9ASCST	5.00
Transparent protective caps for flush push buttons	●○●	—	—	—	—	—	—	—	—	080CPT	5.00
	□	—	—	—	—	—	—	—	—	P9ASCGT	5.00
Colored protective caps for flush push buttons	●○●	080CPN	080CPR	080CPV	080CPG	—	—	—	—	—	5.00
	□	P9ASCGN	P9ASCGR	P9ASCGV	P9ASCGG	—	—	—	—	—	5.00
Protective silicone rubber cap for flush multi-function push buttons	□	—	—	—	—	—	—	—	—	080CPDT	5.00
Transparent flush guard ring	●○●	—	—	—	—	—	—	—	—	P9ARSRPL	1.24*

*Order quantity – 100.

For Illuminated Devices

Item	Style(s)	Catalog No.							List Price, GO-10GC
		Red	Green	Yellow	Orange	Blue	White	Clear	
Refracted pilot light lenses	●○●□	P9ARGLRR	P9ARGLRV	P9ARGLRG	P9ARGLRA	P9ARGLRL	P9ARGLRB	P9ARGLRI	\$1.00
Diffused pilot light lenses ¹	●○●□	P9ARGLDR	P9ARGLDV	P9ARGLDG	P9ARGLDA	P9ARGLDL	P9ARGLDB	P9ARGLDI	.50
	□	P9ASGLDR	P9ASGLDV	P9ASGLDG	P9ASGLDA	P9ASGLDL	P9ASGLDB	P9ASGLDI	1.00
Diffusers for pilots lights	●○●	—	—	—	—	—	—	P9ARDLS	.50
	□	—	—	—	—	—	—	P9ASDPL	.50*
Diffused push button lenses ¹	●○●	P9ARGPDR	P9ARGPDV	P9ARGPDG	P9ARGPDA	P9ARGPDL	P9ARGPDB	P9ARGPDI	.50
	□	P9ASGPDR	P9ASGPDV	P9ASGPDG	P9ASGPDA	P9ASGPDL	P9ASGPDB	P9ASGPDI	1.00
Diffusers for push buttons	●○●	—	—	—	—	—	—	P9ARDPL	.50
	□	—	—	—	—	—	—	P9ASDPL	.50*
Glass pilot light lenses	●○	P9ARGLVR	P9ARGLVW	P9ARGLVG	P9ARGLVA	P9ARGLVL	P9ARGLVB	P9ARGLVI	13.50
Illuminated mushroom heads, 40mm	●○●	P9ARGP4R	P9ARGP4V	P9ARGP4G	P9ARGP4A	P9ARGP4L	P9ARGP4B	P9ARGP4I	7.00
Illuminated mushroom heads, 29mm	□	P9ASGP3R	P9ASGP3V	P9ASGP3G	P9ASGP3A	P9ASGP3L	P9ASGP3B	P9ASGP3I	7.00
Illuminated knobs	●○●□	P9ACGSLR	P9ACGSLV	P9ACGSLG	P9ACGSLA	P9ACGSLL	P9ACGSLB	P9ACGSLI	3.00
Heads for push pull mushroom-head push buttons (40mm)	●○●□	P9ACGP4R	P9ACGP4V	P9ACGP4G	P9ACGP4A	P9ACGP4L	P9ACGP4B	P9ACGP4I	8.00
Protective silicone rubber cap for flush multi-function push buttons	□	—	—	—	—	—	—	080CPDT	5.00
Transparent protective cap for extended & flush push buttons	●○●	—	—	—	—	—	—	P9ARCST	5.00
	□	—	—	—	—	—	—	P9ASCST	5.00

¹ Must order diffuser separately for round devices. Diffuser is built into square devices.

*Order quantity – 100.

Style Legend

● Polished Chrome	○ Satin Chrome	● Round Engineered Plastic	□ Square Engineered Plastic	□ Unibloc (Round Engineered Plastic)	□ Multi-function
-------------------	----------------	----------------------------	-----------------------------	--------------------------------------	------------------



勝特力材料 886-3-5753170
 勝特力电子(上海) 86-21-54151736
 勝特力电子(深圳) 86-755-83298787
[Http://www.100y.com.tw](http://www.100y.com.tw)

C-2000™ Push Buttons

Spare Keys

(For All Operator Styles)



Description	Catalog No.	List Price GO-10GC ¹
Standard Keys #3095	077C3095	\$1.50 each
Special Keys #3353	077C3353	2.00 each
Special Keys #9901	077C9901	2.00 each
Special Keys #9902	077C9902	2.00 each
Special Keys #9903	077C9903	2.00 each
Special Keys #9904	077C9904	2.00 each
Special Keys #9905	077C9905	2.00 each
Special Keys #9910	077C9910	2.00 each
Special Keys #9916	077C9916	2.00 each
Special Keys #9919	077C9919	2.00 each
Special Keys #R455 (Ronis key)	077CR455	2.00 each
Yellow Colored Keys #73033	077CF73033	2.00 each
Black Colored Keys #73034	077CF73034	2.00 each
Red Colored Keys #73037	077CF73037	2.00 each
Blue Colored Keys #73038	077CF73038	2.00 each
Orange Colored Keys #73040	077CF73040	2.00 each

¹ Package quantity is five; order in multiples of five.

Plastic Enclosures, Nameplates, Contact Blocks & Power Supplies For Base-Mounted Pilot Devices

(NEMA 1, 3, 3R, 3S, 4, 4X, 12, 13 & IP66)

For use with operators from pages 15-35.



Plastic Enclosures — Use only with P9S or P9X plastic operators

Holes	Color	Catalog No.	List Price, GO-10GC
1	Gray With Yellow Cover	P9EPEG1	\$15.00
1	Gray	P9EPE01	15.00
2	Gray	P9EPE02	17.50
3	Gray	P9EPE03	22.50
4	Gray	P9EPE04	32.00
6	Gray	P9EPE06	49.00

Ground Terminal

Catalog No.	List Price, GO-10GC
P9AEMT	\$1.00

Legend Plates For Plastic Enclosures (Self-adhesive, black background)

List Price \$1.50 each, GO-10GC ¹		List Price \$1.50 each, GO-10GC ¹		List Price \$1.50 each, GO-10GC ¹		List Price \$1.50 each, GO-10GC ¹	
Symbol		English		French		Spanish	
Symbol	Catalog No.	Legend	Catalog No.	Legend	Catalog No.	Legend	Catalog No.
→	P9AELN006	Stop	P9AELN201	Arrêt	P9AELN301	Cerrar	P9AELN501
I	P9AELN028	Start	P9AELN202	Arrière	P9AELN302	Adelante	P9AELN502
0	P9AELN029	Down	P9AELN203	Avant	P9AELN303	Izquierda	P9AELN504
II	P9AELN035	Up	P9AELN204	Descente	P9AELN304	Bajar	P9AELN505
III	P9AELN038	Close	P9AELN205	Droite	P9AELN305	Abrir	P9AELN506
I-I	P9AELN039	Open	P9AELN206	Gauche	P9AELN306	Subir	P9AELN507
0-1	P9AELN042	On	P9AELN212	Marche	P9AELN308	Atras	P9AELN508
		Off	P9AELN213	Fermer	P9AELN309	Derecha	P9AELN509
		Forward	P9AELN214	Manuel	P9AELN312	Marcha	P9AELN510
		Reverse	P9AELN215	Ouvrir	P9AELN316	Paro	P9AELN511
		Auto	P9AELN219			Rapido	P9AELN512
		Left	P9AELN222			Rearme	P9AELN515
		Right	P9AELN224			Linea	P9AELN523

Type	Catalog No.	List Price Each, GO-10GC
Blank	P9AELN	\$5.01
Custom engraved, seven characters maximum	P9AELNEN	8.00

¹ Package quantity is five; order in multiples of five.

Base-Mount Power Supplies (Screw Terminals Only)

Replace **asterisk (*)** in LED catalog number with code from LED colors table below. See page 48 for full-voltage integrated LED power supplies.

Type	Voltage AC/DC	Catalog No. With Incandescent Bulb	List Price, GO-10GC	Catalog No. With LED	List Price, GO-10GC	Catalog No. With Neon Bulb	List Price, GO-10GC
Full Voltage	No Lamp	P9PDNBO	\$17.50	—	—	—	—
	6	P9PDNBA	21.00	P9PDNBAL*	\$36.00	—	—
	12	P9PDNBB	21.00	P9PDNBBL*	36.00	—	—
	24	P9PDNBD	21.00	P9PDNBDL*	36.00	—	—
	48	P9PDNBG	21.00	P9PDNBGL*	36.00	—	—
	60	P9PDNBH	21.00	—	—	—	—
	110	—	—	—	—	P9PDNBIN	\$25.00
	120	—	—	—	—	P9PDNBIL*	36.00
	130	P9PDNBL	21.00	—	—	—	—
	220	—	—	—	—	P9PDNBMN	25.00
Standard Resistor	110-120 ²	P9PRNBJ	14.00	—	—	—	—
	220-240 ³	P9PRNBN	14.00	—	—	—	—
Diode Resistor ¹	220-240	P9PRDBN	35.00	—	—	—	—
Long Life Resistor	110-120	P9PRLBJ	35.00	—	—	—	—

¹ AC Only

² Must be used with P9PDNBH full voltage power supply (wired in series).

³ Must be used with P9PDNBL full voltage power supply (wired in series).

* LED Colors

Colors	Red	Green	Yellow	Orange	White	Blue
*Color code	R	V	G	A	B	L

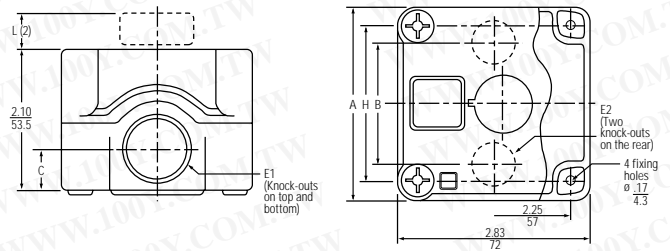

Dimensions (in/mm)

Holes	Center distance	A		B		C		E1 Ø		E2 Ø ¹		H		
		in	mm	in	mm	in	mm	in	mm	in	mm			
1	—	2.83	72	1.81	46	.65	16.5	.91	23	.61	15.5	2.24	57	
2	1.18	30	4.33	110	3.07	78	.65	16.5	.91	23	.85	21.5	3.74	95
3	1.18	30	5.51	140	4.25	108	.65	16.5	.91	23	.85	21.5	4.92	125
4	1.18	30	6.89	175	5.63	143	.65	16.5	.91	23	.85	21.5	6.30	160
6	1.18	30	9.25	235	7.87	200	.77	19.5	1.14	29	.91	23	8.66	220

¹ 1, 2, 3 and 4 hole enclosures suitable for cable gland, with locknut, PG16 or 1/2" NPT.
 6 hole enclosure suitable for cable gland, with locknut, PG21 or 3/4" NPT.

Base-Mount Contact Blocks (Screw Terminals Only)

Type	Contacts	Catalog No.	List Price, GO-10GC
Base-Mount	1NO	P9B10BN	\$7.50
Base-Mount	1NC	P9B01BN	7.50

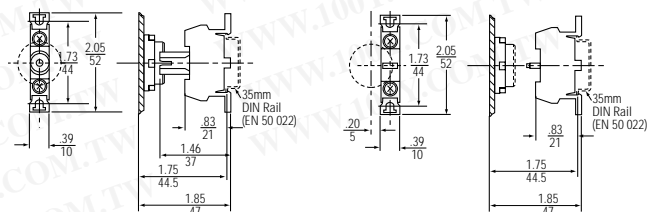

Base Mount Power Supply

Base Mount Contact Blocks With Screw Terminals

Dimensions shown in inches / millimeters



勝特力材料 886-3-5753170
 勝特力电子(上海) 86-21-54151736
 勝特力电子(深圳) 86-755-83298787
[Http://www.100y.com.tw](http://www.100y.com.tw)

C-2000™ Push Buttons

Die-Cast Aluminum Enclosures NEMA Type 1, 3, 3R, 3S, 4, 4X, 12, & 13



Holes	Useful Depth (inches/mm)	Catalog No.	List Price, GO-10GC
1	2.83/72	080SP1	\$30.00
	3.82/97	080SP1M	35.00
2	2.83/72	080SP2	35.00
	3.82/97	080SP2M	42.00
3	3.82/97	080SP3	42.00
4	2.83/72	080SP4	43.00
	3.82/97	080SP4M	51.00
6	3.82/97	080SP6	53.00
8	3.82/97	080SP8	63.00
12	3.82/97	080SP12	83.00
18	3.82/97	080SP18	113.00
24	3.82/97	080SP24	143.00
35	4.37/111	080SP35	198.00

Hole Location And Centerline Distances (inches/mm)					Dimensions (inches/mm)					
Model	Vertical	Distance	Horizontal	Distance	A	B	C	D	E	F
1	—	—	—	—	3.43/87	3.43/87	2.95/75	2.83/72	.846/21.5	PG21
1M	—	—	—	—	3.43/87	3.43/87	3.94/100	3.82/97	.846/21.5	PG21
2	2	1.97/50	—	—	5.71/145	3.43/87	2.95/75	2.83/72	.846/21.5	PG21
2M	2	1.97/50	—	—	5.71/145	3.43/87	3.94/100	3.82/97	.846/21.5	PG21
3	3	1.97/50	—	—	7.67/195	3.43/87	3.94/100	3.82/97	.846/21.5	PG21
4	2	1.97/50	2	1.18/30	5.71/145	3.43/87	2.95/75	2.83/72	.846/21.5	PG21
4M	2	1.97/50	2	1.18/30	5.71/145	3.43/87	3.94/100	3.82/97	.846/21.5	PG21
6	3	1.97/50	2	1.18/30	7.67/195	3.43/87	3.94/100	3.82/97	.846/21.5	PG21
8	2	1.97/50	4	1.18/30	5.98/152	5.98/152	3.94/100	3.82/97	1.06/27	PG29
12	3	1.97/50	4	1.18/30	8.07/205	9.05/230	3.94/100	3.82/97	1.06/27	PG29
18	3	1.97/50	6	1.18/30	10.12/257	11.81/300	3.94/100	3.82/97	1.37/35	PG36
24	4	1.97/50	6	1.18/30	10.12/257	11.81/300	3.94/100	3.82/97	1.37/35	PG36
35	5	1.97/50	7	1.18/30	13.78/350	13.78/350	4.80/122	4.37/111	1.61/41	PG36

Metric To NPT Adaptors

Type	Catalog No.	List Price, GO-10GC
PG21 to 1/2 inch	080PG21A	\$25.00
PG21 to 3/4 inch	080PG21B	25.00
PG29 to 1 inch	080PG29C	25.00
PG36 to 1 1/4 inch	080PG36D	25.00

Hole Disposition And Centerline Distances (inches/mm)					Dimensions (inches/mm)					
Model	Vertical	Distance	Horizontal	Distance	A	B	C	D	E	F
1	—	—	—	—	3.43/87	3.43/87	2.95/75	2.83/72	.846/21.5	PG21
1M	—	—	—	—	3.43/87	3.43/87	3.94/100	3.82/97	.846/21.5	PG21
2	2	1.97/50	—	—	5.71/145	3.43/87	2.95/75	2.83/72	.846/21.5	PG21
2M	2	1.97/50	—	—	5.71/145	3.43/87	3.94/100	3.82/97	.846/21.5	PG21
3	3	1.97/50	—	—	7.67/195	3.43/87	3.94/100	3.82/97	.846/21.5	PG21
4	2	1.97/50	2	1.18/30	5.71/145	3.43/87	2.95/75	2.83/72	.846/21.5	PG21
4M	2	1.97/50	2	1.18/30	5.71/145	3.43/87	3.94/100	3.82/97	.846/21.5	PG21
6	3	1.97/50	2	1.18/30	7.67/195	3.43/87	3.94/100	3.82/97	.846/21.5	PG21
8	2	1.97/50	4	1.18/30	5.98/152	5.98/152	3.94/100	3.82/97	1.06/27	PG29
12	3	1.97/50	4	1.18/30	8.07/205	9.05/230	3.94/100	3.82/97	1.06/27	PG29
18	3	1.97/50	6	1.18/30	10.12/257	11.81/300	3.94/100	3.82/97	1.37/35	PG36
24	4	1.97/50	6	1.18/30	10.12/257	11.81/300	3.94/100	3.82/97	1.37/35	PG36
35	5	1.97/50	7	1.18/30	13.78/350	13.78/350	4.80/122	4.37/111	1.61/41	PG36

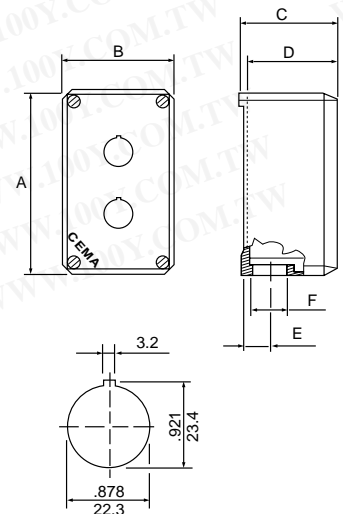

Dimensions shown in $\frac{\text{inches}}{\text{millimeters}}$

Sheet Steel & Stainless Steel Enclosures



勝特力材料 886-3-5753170
 勝特力电子(上海) 86-21-54151736
 勝特力电子(深圳) 86-755-83298787
[Http://www.100y.com.tw](http://www.100y.com.tw)

Holes	Sheet Steel		Stainless Steel		Dimensions (inches/mm)						
	Catalog No.	List Price, GO-10GC	Catalog No.	List Price, GO-10GC	A	B	C	D	E	F	Hub (inches)
1	080HEG11	\$42.00	080HES11	\$102.00	5.50/139.7	3.50/88.9	4.25/108.0	5.00/127.0	2.38/60.4	.31/7.9	3/4
2	080HEG12	45.00	080HES12	120.00	7.75/196.8	3.50/88.9	4.25/108.0	7.25/184.2	2.38/60.4	.31/7.9	3/4
3	080HEG13	48.00	080HES13	132.00	7.75/196.8	3.50/88.9	4.25/108.0	7.25/184.2	2.38/60.4	.31/7.9	3/4
4	080HEG14	54.00	080HES14	156.00	13.38/339.8	3.50/88.9	4.25/108.0	12.88/327.2	2.38/60.4	.31/7.9	1
6	080HEG32	72.00	080HES32	198.00	8.25/209.6	6.50/165.1	4.25/108.0	7.75/196.8	5.88/149.4	.31/7.9	1
9	080HEG33	84.00	080HES33	312.00	10.50/266.7	7.00/177.8	4.25/108.0	10.00/254.0	5.88/149.4	.31/7.9	1 1/4
12	080HEG43	108.00	080HES43	336.00	10.50/266.7	9.25/235.0	4.25/108.0	10.00/254.0	8.19/208.0	.31/7.9	1 1/2
16	080HEG44	138.00	080HES44	432.00	12.75/323.8	9.25/235.0	4.25/108.0	12.25/311.2	8.19/208.0	.31/7.9	1 1/2
24	080HEG64	216.00	080HES64	660.00	12.75/323.8	11.50/292.1	4.25/108.0	12.25/311.2	10.38/263.6	.31/7.9	1 1/2
30	080HEG65	240.00	080HES65	780.00	15.00/381.00	11.50/292.1	4.25/108.0	14.50/368.3	10.38/263.6	.38/9.6	1 1/2

Special Assembled Unwired Stations

Holes	Sheet Steel		Stainless Steel	
	Catalog No.	List Price, GO-10GC	Catalog No.	List Price, GO-10GC
1	080HEG11B	\$60.00	080HES11B	\$120.00
2	080HEG12B	69.00	080HES12B	144.00
3	080HEG13B	78.00	080HES13B	162.00
4	080HEG14B	90.00	080HES14B	192.00
6	080HEG32B	120.00	080HES32B	246.00
9	080HEG33B	150.00	080HES33B	378.00
12	080HEG43B	192.00	080HES43B	420.00
16	080HEG44B	246.00	080HES44B	540.00
24	080HEG64B	378.00	080HES64B	822.00
30	080HEG65B	432.00	080HES65B	972.00

When ordering assembled, unwired stations, specify units and nameplates by hole position as shown below. Prices do not include operators, terminals, nameplates, etc.

Hole Arrangements

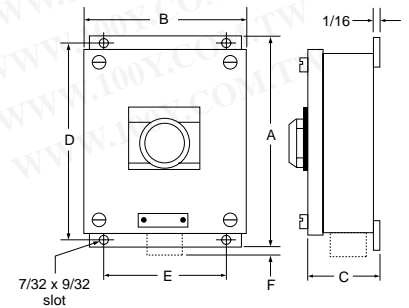
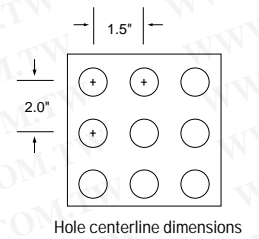
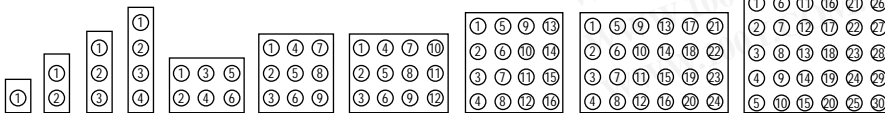

Sheet- and stainless-steel enclosures



勝特力材料 886-3-5753170
 勝特力电子(上海) 86-21-54151736
 勝特力电子(深圳) 86-755-83298787
 Http://www.100y.com.tw

C-2000™ Push Buttons

Accessories

For Use With	Accessory	Description	Catalog No.	List Price, G0-10GC
○ ○ ● □	Locking ring wrench	For tightening of metal locking ring	P9ACWAF	\$7.50
○ ○ ● □	Printed circuit board adapter	Use with contact blocks and power supplies with quick connect terminals; solder connection to printed circuit board	P9ACA6	4.00
○ ○ ● □	Flange for 3 contact blocks	Standard flange provided with all operators	P9ACFS3	3.00
○ ○ ● □	Flange for 5 contact blocks	Optional flange for mounting of maximum number of contact blocks	P9ACFS5	4.50
○ ○ ● □	Padlocking device with clear cover	Limits access to push buttons (flush and extended) and knob selector switch	P9ACRCL	15.00
○ ○ ●	Extended guard for 40 mm mushroom-head push button	Prevents accidental actuation of mushroom head push button	P9ARRE4	10.00
○ ○ ●	Orientation tab bypass ring	Allows mounting of devices in panels without locating notch	P9ARAND	2.00
○ ○ ●	Orientation tab extender	Extends operator tab from 1.5 mm to 2.5 mm allowing mounting of devices on very thick panels	P9ARADE	2.00
○ ○ ●	Ring reducer, black plastic	Adapter allows C-2000 devices to be mounted in 30 mm diameter hole	P9ARAX32	7.50
○ ○ ●	Ring reducer, polished chrome	Adapter allows C-2000 devices to be mounted in 30 mm diameter hole	P9ARAM32	7.50
□	Cap and lens extractor	Provides easy removal of caps and lenses	P9ASEBG	7.00
○ ○ ● □	Lamp extractor	Provides easy removal of bulbs	080ESL	4.00
○ ○ ●	Enclosure hole plug, black plastic	Plugs unused holes in panel	P9ARHPR	5.00
□	Enclosure hole plug, 30 x 30 mm, black plastic	Plugs unused holes in panel	P9ASHP3	5.00
□	Enclosure hole plug, 30 x 50 mm, black plastic	Plugs unused holes in panel	P9ASHP5	5.00
○ ○ ● □	Push-on/push-off device	Converts a momentary push button into a maintained push button (use only early make contact [P9B10VA] when normally open contact is desired)	P9ACDPP	26.00
—	Assembled 4-device tabletop display	Handy display of C-2000 push buttons	P9ACT04	120.00
—	Assembled 16-device tabletop display	Handy display of C-2000 push buttons	P9ACT16	250.00
—	Sample case	Portable overview of C-2000 push buttons	P9ACKITU	250.00
○ ○ ● □	Marking plate, white	Snaps on back of contact block for circuit identification	P9ACPIU	2.50 (10 qty)

Style Legend

● Polished Chrome	○ Satin Chrome	● Round Engineered Plastic	□ Square Engineered Plastic
-------------------	----------------	----------------------------	-----------------------------

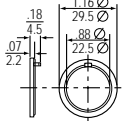

Orientation Tab Extender

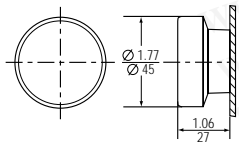

Extended Guard For 40mm Mushroom-head Push Button

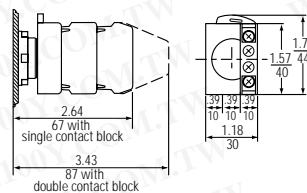

Push-On/Push-Off Device

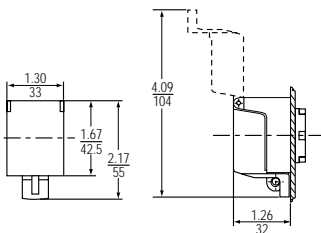

Padlocking Attachment

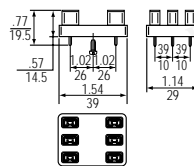

Printed Wiring Board Adapter

Dimensions shown in inches
millimeters

勝特力材料 886-3-5753170
勝特力电子(上海) 86-21-54151736
勝特力电子(深圳) 86-755-83298787
[Http://www.100y.com.tw](http://www.100y.com.tw)

C-2000™ Push Buttons

Accessories



Locking Ring Wrench



Printed Circuit Board Adapter



Padlocking Device With Clear Cover



Ring Reducers, Black Plastic and Polished Chrome



Lamp Extractor



Push-On/Push-Off Device



Enclosure Hole Plugs



Assembled 16-Device Tabletop Display



勝特力材料 886-3-5753170
 勝特力电子(上海) 86-21-54151736
 勝特力电子(深圳) 86-755-83298787
 Http://www.100y.com.tw

C-2000™ Push Buttons

Lamps



Replace **asterisk (*)** in LED type catalog number from colors table below.

Type	Voltage	Watts	Catalog Number	List Price, GO-10GC
Incandescent	6 AC/DC	0.6	BA9S606	\$3.00
	6 AC/DC	1.5	BA9S615	3.00
	12 AC/DC	2	BA9S122	3.00
	24 AC/DC	2	BA9S242	3.00
	48 AC/DC	2	BA9S48	3.00
	60 AC/DC	1.2	BA9S6012	3.00
	130 AC/DC	2	BA9S130	3.00
Neon	110 AC (94 AC minimum starting voltage)	0.077	BA9SN110	7.00
	220 AC (186 AC minimum starting voltage)	0.33	BA9SN220	7.00
LED	6 AC/Polarized DC (center anode positive)	0.59	080BA9S6L*	18.00
	12 AC/DC	0.78	080BA9S12L*	18.00
	24 AC/DC	0.84	080BA9S24L*	18.00
	48 AC/DC	1.12	080BA9S48L*	18.00
	120 AC	1.4	080BA9S120L*	18.00

*LED Colors

Colors	Red	Green	Yellow	Orange	White	Blue
*Color code	R	V	G	A	B	L

New Full Voltage Integrated LED Power Supplies

See back cover foldout for complete line of power supplies and contact blocks.



- the brightest light for the best illumination
- integrated power supply and LED lamp simplify ordering, installation and maintenance
- your choice of base or panel mount options
- 100,000 hours of continuous operation – approximately 10 years of service life – at least 20 times longer than traditional filament lamps
- low energy consumption & no risk of overheating
- superior resistance to vibrations and accidental bumps

Mounting	Type	Voltage	Catalog Number	List Price, GO-10GC
Panel Mount	Steady	24V ac/dc	P9PLNVD*	\$31.00
		120V	P9PLNVJ*	31.00
		230V	P9PLNVN*	31.00
	Flashing	24V ac/dc	P9PLFVD*	56.50
		120V	P9PLFVJ*	56.50
		230V	P9PLFVN*	56.50
Base Mount	Steady	24V ac/dc	P9PLNBD*	37.00
		120V	P9PLNBJ*	37.00
		230V	P9PLNBN*	37.00

*LED Colors

Colors	Red	Green	Yellow	Orange	White	Blue
*Color code	R	V	G	A	B	L

Assembled Forms

C-2000 push buttons may be ordered factory assembled with a single catalog number and list price. These may be selected from either the Common Forms or Special Forms sections below.

Common Forms

Listed below are the most commonly ordered assembled push button devices. These devices are shipped factory assembled with contact blocks and/or power supplies mounted on the operator. For assembled devices not listed, see the Special Forms section following for data on developing catalog number and list price. All assembled devices carry an assembly charge of \$5.00, which is reflected in the list price, GO-10GC, shown. *Minimum order quantity is 10 per item. For smaller quantities, order individual components from pages 15-48.*

Complete the assembled device catalog number by substituting the desired operator style (*), operator color (†), and/or lens color (‡) with the appropriate digits from the tables below.

* Operator Style

Style	<input type="radio"/> Polished Chrome	<input type="radio"/> Satin Chrome	<input checked="" type="radio"/> Round Engineered Plastic	<input type="checkbox"/> Square Engineered Plastic
*Style Code	C	M	X	S

† Operator Color

Color	Red	Green	Yellow	Blue	White	Brown	Gray
†Color Code	R	V	G	L	B	M	H

‡ Lens Color

Color	Red	Green	Black	Yellow	Blue	White	Orange	Clear
‡Color Code	R	V	N	G	L	B	A	I

Operator Type	Description	Catalog Number	List Price, GO-10GC	Consists of Components		
				Operator	Contact Block(s)	Power Supply
Standard push button, flush	1NO	P9*PN†GN10N0	\$20.00	P9*PN†G	P9B10VN	—
	1NC	P9*PN†GN20N0	20.00	P9*PN†G	P9B01VN	—
	1NO-1NC	P9*PN†GN30N0	27.50	P9*PN†G	P9B11VN	—
Standard push button, extended	1NO	P9*PN†SN10N0	20.00	P9*PN†S	P9B10VN	—
	1NC	P9*PN†SN20N0	20.00	P9*PN†S	P9B01VN	—
	1NO-1NC	P9*PN†SN30N0	27.50	P9*PN†S	P9B11VN	—
Standard push button, recessed	1NO	P9*PN†EN10N0	20.00	P9*PN†E	P9B10VN	—
	1NC	P9*PN†EN20N0	20.00	P9*PN†E	P9B01VN	—
	1NO-1NC	P9*PN†EN30N0	27.50	P9*PN†E	P9B11VN	—
Mushroom-head push button, 40mm diameter, red <i>(continued on next page)</i>	Momentary, 1 NC	P9*EM4RNN20N0	29.00	P9*EM4RN	P9B01VN	—
	Push-pull, maintained, 1NC	P9*ET4RN1200	34.00	P9*ET4RN1	P9B01VN	—
	Push to latch-turn to release, 1NC, polished chrome	P9CER4RNN20N0	51.00	P9CER4RN	P9B01VN	—
	Push to latch-turn to release, 1NC, satin chrome	P9MER4RNN20N0	51.00	P9CER4RN	P9B01VN	—
	Push to latch-turn to release, 1NC, positive action, round engineered plastic	P9XER4RAN20N0	51.00	P9XER4RA	P9B01VN	—
	Push to latch-turn to release, 1NC, positive action, square engineered plastic	P9SER4RAN20N0	51.00	P9SER4RA	P9B01VN	—
	Push to latch-key release, 1NC, standard key, polished chrome	P9CEC4RN95N20N0	66.00	P9CEC4RN95	P9B01VN	—
	Push to latch-key release, 1NC, standard key, satin chrome	P9MEC4RN95N20N0	66.00	P9CEC4RN95	P9B01VN	—



勝特力材料 886-3-5753170
勝特力电子(上海) 86-21-54151736
勝特力电子(深圳) 86-755-83298787
[Http://www.100y.com.tw](http://www.100y.com.tw)

C-2000™ Push Buttons

Common Forms (continued)

Complete the assembled device catalog number by substituting the desired operator style (*), operator color (†), and/or lens color (‡) with the appropriate digits from the tables below.

* Operator Style

Style	<input type="radio"/> Polished Chrome	<input type="radio"/> Satin Chrome	<input checked="" type="radio"/> Round Engineered Plastic	<input type="checkbox"/> Square Engineered Plastic
*Style Code	C	M	X	S

† Operator Color

Color	Red	Green	Yellow	Blue	White	Brown	Gray
†Color Code	R	V	G	L	B	M	H

‡ Lens Color

Color	Red	Green	Black	Yellow	Blue	White	Orange	Clear
‡Color Code	R	V	N	G	L	B	A	I

Operator Type	Description	Catalog Number	List Price, GO-10GC	Consists of Components		
				Operator	Contact Block(s)	Power Supply
Mushroom-head push button, 40mm diameter, red <i>(continued from previous page)</i>	Push to latch-key release, 1NC, standard key, positive action, round engineered plastic	P9XEC4RA95N20N0	66.00	P9XEC4RA95	P9B01VN	—
	Push to latch-key release, 1NC, standard key, positive action, square engineered plastic	P9SEC4RA95N20N0	66.00	P9SEC4RA95	P9B01VN	—
Illuminated push button, extended	24V, full voltage, 1NO-1NC	P9*PL†SDN12NADI	51.50	P9*PL†SD	P9B10VN, P9B01VN	P9PDNVD
	120V, full voltage, 1NO-1NC	P9*PL†SDN12NALI	51.50	P9*PL†SD	P9B10VN, P9B01VN	P9PDNVJ
	120V, transformer, 1NO-1NC	P9*PL†SDN30NGJI	73.00	P9*PL†SD	P9B11VN	P9PTNVJ
Illuminated mushroom-head push button, momentary, 40mm diameter ¹	24V, full voltage, 1NO-1NC, round	P9*EM4‡LN12NADI	57.50	P9*EM4‡L	P9B10VN, P9B01VN	P9PDNVD
	24V, full voltage, 1NO-1NC, square	P9SEM3‡LN12NADI	57.50	P9SEM3‡L	P9B10VN, P9B01VN	P9PDNVD
	120V, full voltage, 1NO-1NC, round	P9*EM4‡LN12NALI	57.50	P9*EM4‡L	P9B10VN, P9B01VN	P9PDNVL
	120V, full voltage, 1NO-1NC, square	P9SEM3‡LN12NALI	57.50	P9SEM3‡L	P9B10VN, P9B01VN	P9PDNVL
	120V, transformer, 1NO-1NC, round	P9*EM4‡LN30NGJI	79.00	P9*EM4‡L	P9PB11VN	P9PTNVJ
	120V, transformer, 1NO-1NC, square	P9SEM3‡LN30NGJI	79.00	P9SEM3‡L	P9PB11VN	P9PTNVJ
Illuminated mushroom-head push button, push-pull maintained	24V, full voltage, 1NO-1NC	P9*ET4‡L112ADI	64.50	P9*ET4‡L1	P9B10VN, P9B01VN	P9PDNVD
	120V, full voltage, 1NO-1NC	P9*ET4‡L112ALI	64.50	P9*ET4‡L1	P9B10VN, P9B01VN	P9PDNVL
	120V, transformer, 1NO-1NC	P9*ET4‡L130GJI	86.00	P9*ET4‡L1	P9PB11VN	P9PTNVJ
Pilot light, diffused	24V, full voltage	P9*L†DADI	32.00	P9*L†D	—	P9PDNVD
	120V, full voltage	P9*L†DALI	32.00	P9*L†D	—	P9PDNVL
	120V, transformer	P9*L†DGJI	48.50	P9*L†D	—	P9PTNVJ
Pilot light, refracted	24V, full voltage	P9*L†RADI	32.00	P9*L†R	—	P9PDNVD
	120V, full voltage	P9*L†RALI	32.00	P9*L†R	—	P9PDNVL
	120V, transformer	P9*L†RGJI	48.50	P9*L†R	—	P9PTNVJ
Selector switch with black knob	2-position, maintained, 90° throw, 1NO-1NC	P9*SMD0NN12N0	34.50	P9*SMD0N	P9B10VN, P9B01VN	—
	3-position, maintained, 45° throw, 1NO-1NC	P9*SMZ0NN12N0	34.50	P9*SMZ0N	P9B10VN, P9B01VN	—
	4-position, 45° throw, 2NO-2NC	P9*SMX0NN33N0	49.50	P9*SMX0N	(2)P9B11VN	—
	5-position, 40° throw, 2NO-2NC	P9*SMY0NN33N0	61.00	P9*SMY0N	(2)P9B11VN	—

¹Square mushroom head is 29mm diameter.

Special Forms

To specify and order special forms of assembled devices, first select the operator from pages 15-35. With the operator's catalog number as a prefix, add the digits from the appropriate section below (non-illuminated, illuminated or push-pull/multi-function) to specify contact blocks and/or power supplies. Total list price is derived from operator list price plus contact block and/or power supply list price(s) plus \$5.00 assembly charge.

Non-illuminated devices

From the table below, choose desired contact block(s) and transfer the catalog number digit to the appropriate flange position box in the catalog number matrix. For flange position(s) without a contact block, enter 0 in the corresponding box in the catalog number matrix. The resulting number is your complete assembled catalog number. The total list price is the sum of the list prices for operator and contact block(s) plus \$5.00 assembly charge. *Minimum order quantity is 10 per item. For smaller quantities, order individual components from pages 15-48.*

Note: Use the 3-position flange unless the number of contact blocks required exceeds 3-position flange capacity.

Contact Blocks

Terminal Type	Contacts	Possible Flange Position(s)	Catalog No. Digit	List Price, GO-10GC
		1 3 2		
No contact block			0	\$0.00
Screw	1 NO		1	7.50
	1NC		2	7.50
	1NO-1NC	■ □ □	3	15.00
	1 NO early make	□ □ ■	6	7.50
	1 NC late opening	□ □ ■	7	7.50
Quick Connect	1 NO		4	7.50
	1 NC		5	7.50

Catalog Number Matrix

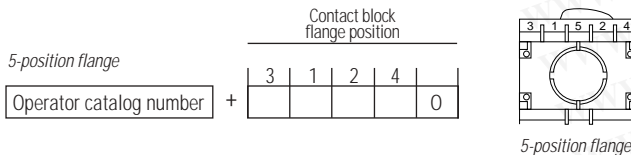
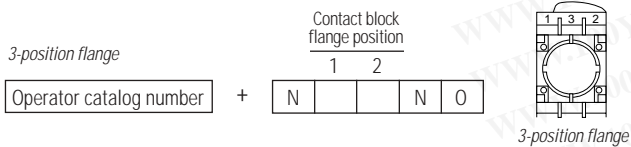



勝 特 力 材 料 886-3-5753170
 勝 特 力 电 子 (上 海) 86-21-54151736
 勝 特 力 电 子 (深 圳) 86-755-83298787
[Http://www.100y.com.tw](http://www.100y.com.tw)

C-2000™ Push Buttons

Illuminated Devices

From the contact block table below, choose desired contact block(s) and transfer the catalog number digit to the appropriate flange position box in the catalog number matrix corresponding to your operator type. For flange position(s) without a contact block, enter 0 in the corresponding box in the catalog number matrix. (Pilot lights have no contact blocks and their matrix has no contact block positions.)

Then select your power supply from the appropriate table — full voltage, transformer or resistor. Transfer the catalog number digits to the power supply boxes in the same catalog number matrix.

Except as noted below, use the 3-position flange catalog number matrix for all devices.

When to use the 5-position flange and its catalog number matrix:

- If you require a flashing power supply and one or two contact blocks
- If you require a standard resistor, standard transformer or any panel test power supply and more than one contact block.

Flashing power supplies occupy slots 1-5-2 on the 5-position flange, so contact block catalog number digits must be entered for positions 3 and/or 4 only; enter zero (0) as the catalog number digit for positions 1 and 2. **Non-flashing transformer, standard resistor and all panel test power supplies** occupy slots 1 and 5 on the 5-position flange, so contact block catalog number digits must be entered for position 2, 3 and 4 only; enter zero (0) as the catalog number digit for any positions without a contact block.

The resulting number is your complete assembled catalog number. The total list price (GO-10GC) is the sum of the list prices for operator, contact block(s) and power supply plus \$5.00 assembly charge. *Minimum order quantity is 10 per item. For smaller quantities, order individual components from pages 15-48.*

Contact Blocks

Terminal Type	Contacts	Possible Flange Position(s)	Catalog No. Digit	List Price, GO-10GC
No contact block			0	\$0.00
Screw	1 NO		1	7.50
	1NC		2	7.50
	1NO-1NC		3	15.00
	1 NO early make		6	7.50
	1 NC late opening		7	7.50
Quick Connect	1 NO		4	7.50
	1 NC		5	7.50

Transformer Power Supplies

Transformer Type	Voltage (AC)	Possible Flange Position(s)	Lamp Type			
			Incandescent		LED	
			Catalog No. Digits	List Price, GO-10GC	Catalog No. Digits	List Price, GO-10GC
Standard Screw Terminal	48		GGI	\$42.50	GGL	\$57.50
	60		GHI	42.50	GHL	57.50
	110-120		GJI	42.50	GJL	57.50
	220-250		GNI	42.50	GNL	57.50
	277-280		GRI	42.50	GRL	57.50
	380		GVI	42.50	GVL	57.50
	415-440		GWI	42.50	GWL	57.50
	480-500		GVI	42.50	GVL	57.50
550-600	GZI	42.50	GZL	57.50		
Standard Screw Terminal, Flashing	48		IGI	72.50	IGL	87.50
	60		IHI	72.50	IHL	87.50
	110-120		IJI	72.50	IJL	87.50
	220-250		INI	72.50	INL	87.50
	277-280		IRI	72.50	IRL	87.50
	380		IUI	72.50	IUL	87.50
	415-440		IWI	72.50	IWL	87.50
	480-500		IYI	72.50	IYL	87.50
	550-600		IZI	72.50	IZL	87.50

勝特力材料 886-3-5753170
 勝特力电子(上海) 86-21-54151736
 勝特力电子(深圳) 86-755-83298787
 Http://www.100y.com.tw

Power Supplies & Contact Blocks

Power Supplies

Type	Power Supply	Voltage	Incandescent		LED		Neon ¹		
			Catalog Number	List Price, GO-10GC	Catalog Number	List Price, GO-10GC	Catalog Number	List Price, GO-10GC	
Full Voltage, AC/DC	Screw Terminal	No lamp	P9PDNVO	\$17.50	—	—	—	—	
		6	P9PDNVA	21.00	P9PDNVAL*	\$36.00	—	—	
		12	P9PDNVB	21.00	P9PDNVBL*	36.00	—	—	
		24	P9PDNVD	21.00	P9PDNVDL*	36.00	—	—	
		48	P9PDNVG	21.00	P9PDNVGL*	36.00	—	—	
		60	P9PDNVH	21.00	—	—	—	—	
		110	—	—	—	—	P9PDNVIN	\$25.00	
		120 (AC only)	—	—	P9PDNVJL*	36.00	—	—	
		130	P9PDNVL	21.00	—	—	—	—	
		220	—	—	—	—	P9PDNVMN	25.00	
	Screw Terminal, Flashing	24	P9PDMVD	51.00	P9PDMVDL*	66.00	—	—	
		120 (AC)	P9PDMVJ	51.00	P9PDMVJL*	66.00	—	—	
	Screw Terminal, Panel Test	No Lamp	P9PDTVO	32.50	—	—	—	—	
		6	P9PDTVA	36.00	P9PDTVAL*	51.00	—	—	
		12	P9PDTVB	36.00	P9PDTVBL*	51.00	—	—	
		24	P9PDTVD	36.00	P9PDTVDL*	51.00	—	—	
		48	P9PDTVG	36.00	P9PDTVGL*	51.00	—	—	
		60	P9PDTVH	36.00	—	—	—	—	
		110	—	—	—	—	P9PDTVIN	40.00	
		120 (AC only)	—	—	P9PDTVJL*	43.50	—	—	
		130	P9PDTVL	36.00	—	—	—	—	
		220	—	—	—	—	P9PDTVMN	40.00	
	Quick Connect Terminal	No lamp	P9PDNFO	17.50	—	—	—	—	
		6	P9PDNFA	21.00	P9PDNFAL*	36.00	—	—	
		12	P9PDNFB	21.00	P9PDNFBL*	36.00	—	—	
		24	P9PDNFD	21.00	P9PDNFDL*	36.00	—	—	
		48	P9PDNFG	21.00	P9PDNFGl*	36.00	—	—	
		60	P9PDNFH	21.00	—	—	—	—	
		110	—	—	—	—	P9PDNFIN	25.00	
		120 (AC only)	—	—	P9PDNFJL*	36.00	—	—	
		130	P9PDNFL	21.00	—	—	—	—	
		220	—	—	—	—	P9PDNFMN	25.00	
	Transformer, 50/60 Hz, AC	Screw Terminal	48	P9PTNVG	42.50	P9PTNVGL*	57.50	—	—
			60	P9PTNVH	42.50	P9PTNVHL*	57.50	—	—
			110-120	P9PTNVJ	42.50	P9PTNVJL*	57.50	—	—
			220-250	P9PTNVN	42.50	P9PTNVNL*	57.50	—	—
			277-280	P9PTNVR	42.50	P9PTNVRl*	57.50	—	—
			380	P9PTNVU	42.50	P9PTNVUL*	57.50	—	—
			415-440	P9PTNVW	42.50	P9PTNVWL*	57.50	—	—
			480-500	P9PTNVY	42.50	P9PTNVYL*	57.50	—	—
550-600			P9PTNVZ	42.50	P9PTNVZL*	57.50	—	—	
Screw Terminal, Flashing			48	P9PTMVG	72.50	P9PTMVGl*	87.50	—	—
		60	P9PTMVH	72.50	P9PTMVHL*	87.50	—	—	
		110-120	P9PTMVJ	72.50	P9PTMVJL*	87.50	—	—	
		220-250	P9PTMVN	72.50	P9PTMVNL*	87.50	—	—	
		277-280	P9PTMVR	72.50	P9PTMVRl*	87.50	—	—	
		380	P9PTMVU	72.50	P9PTMVUL*	87.50	—	—	
		415-440	P9PTMVW	72.50	P9PTMVWL*	87.50	—	—	
		480-500	P9PTMVE	72.50	P9PTMVEL*	87.50	—	—	
		550-600	P9PTMVZ	72.50	P9PTMVZL*	87.50	—	—	
		Resistor, AC/DC	Screw Terminal, Standard	110-120	P9PRNVJ	35.00	—	—	—
220-240				P9PRNVN	35.00	—	—	—	—
Screw Terminal, Diode (AC only)	220-240		P9PRDVN	35.00	—	—	—	—	
	110-120		P9PRLVJ	35.00	—	—	—	—	
Screw Terminal, Long Life	110-120	P9PRLVJ	35.00	—	—	—	—		
	220-240	P9PRTVN	50.00	—	—	—	—		

¹ Neon bulbs are recommended for use only with clear, red and yellow lenses.

Contact Blocks

Contact Block	Type	Contacts	Catalog Number	List Price, GO-10GC
Screw Terminal	Standard	1NO	P9B10VN	\$7.50
		1NC	P9B01VN	7.50
		1NO-1NC	P9B11VN	15.00
		2NO	P9B20VN	15.00
		2NC	P9B02VN	15.00
	Early Make	1NO	P9B10VA	7.50
		1NC	P9B01VR	7.50
	Late Opening	1NO	P9B10BN	7.50
		1NC	P9B01BN	7.50
	Screw Terminal, Time Delay	0.1-30 Seconds	1NO-1NC	P9B11T3
10-180 Seconds		1NO-1NC	P9B11T8	75.00
Quick Connect Terminal	Standard	1NO	P9B10FN	7.50
		1NC	P9B01FN	7.50
	Reed	1NO	P9B10FH	18.00
		1NC	P9B01FH	18.00

New Full Voltage Integrated LED Power Supplies

Combining the brightness, endurance, efficiency and ruggedness of an LED with the simplicity of an all-in-one power supply.

Mounting	Type	Voltage	Catalog Number	List Price, GO-10GC
Panel Mount	Steady	24V ac/dc	P9PLNVD*	\$31.00
		120V	P9PLNVJ*	31.00
		230V	P9PLNVN*	31.00
	Flashing	24V ac/dc	P9PLFVD*	56.50
		120V	P9PLFVJ*	56.50
		230V	P9PLFVN*	56.50
Base Mount	Steady	24V ac/dc	P9PLNBD*	37.00
		120V	P9PLNBj*	37.00
		230V	P9PLNBN*	37.00

* LED Colors

LED Color	Red	Green	Yellow	Blue	Orange	White
*Color Code	R	V	G	L	A	B

Power Supplies & Contact Blocks

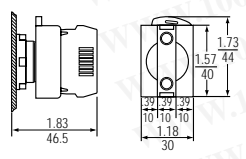

Full Voltage, Long Life, & Resistor & Diode Power Supplies With Screw Terminals

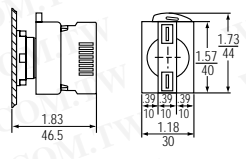

Full Voltage Power Supply With Quick Connect Terminals

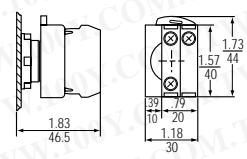

Resistor, Full Voltage Test & Resistor Test Power Supplies With Screw Terminals

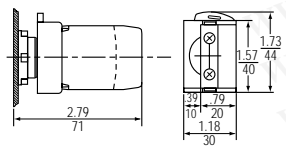

Transformer Power Supply With Screw Terminals

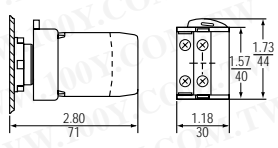

Full Voltage & Transformer Continuous Or Flashing Power Supplies With Screw Terminals

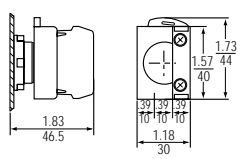

Single Contact Blocks With Screw Terminals

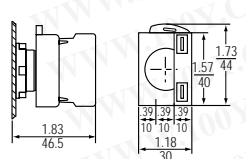

Single Contact Blocks With Quick Connect Terminals

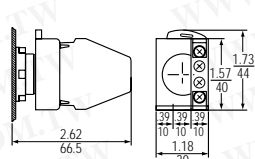

Double Contact Blocks With Screw Terminals

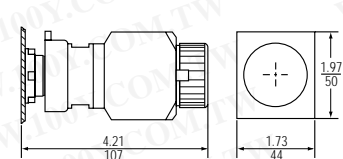

Time Delay Contact Blocks With Screw Terminals

Dimensions shown in inches / millimeters