

**GaAlAs-IR-Lumineszenzdiode (880 nm)**  
**GaAlAs Infrared Emitter (880 nm)**  
**Lead (Pb) Free Product - RoHS Compliant**

**SFH 485 P**

勝特力材料 886-3-5753170  
 勝特力电子(上海) 86-21-54151736  
 勝特力电子(深圳) 86-755-83298787  
[Http://www.100y.com.tw](http://www.100y.com.tw)



**Wesentliche Merkmale**

- GaAlAs-LED mit sehr hohem Wirkungsgrad
- Hohe Zuverlässigkeit
- Gute spektrale Anpassung an Si-Fotoempfänger
- Gegurtet lieferbar (im Ammo-Pack)
- Gruppiert lieferbar
- Gehäusegleich mit SFH 217

**Anwendungen**

- IR-Fernsteuerung von Fernseh- und Rundfunkgeräten, Videorecordern, Lichtdimmern
- Gerätefernsteuerungen für Gleich- und Wechsellichtbetrieb
- Rauchmelder (UL-Freigabe)
- Sensorik
- Diskrete Lichtschranken

**Features**

- Very highly efficient GaAlAs-LED
- High reliability
- Spectral match with silicon photodetectors
- Available on tape and reel (in Ammo-pack)
- Available in bins
- Same package as SFH 217

**Applications**

- IR remote control of hi-fi and TV-sets, video tape recorders, dimmers
- Remote control for steady and varying intensity
- Smoke detectors (UL-approval)
- Sensor technology
- Discrete interrupters

Typ Type	Bestellnummer Ordering Code	Gehäuse Package
SFH 485 P	Q62703Q0516	5-mm-LED-Gehäuse, plan, klares violettes Epoxy-Gießharz, Lötspieße im 2.54-mm-Raster (1/10"), Anodenkennzeichnung: kürzerer Anschluß 5 mm LED package (T 1 3/4), plane violet-colored transparent epoxy resin, solder tabs lead spacing 2.54 mm (1/10"), anode marking: short lead.

**Grenzwerte** ( $T_A = 25\text{ °C}$ )**Maximum Ratings**

Bezeichnung Parameter	Symbol Symbol	Wert Value	Einheit Unit
Betriebs- und Lagertemperatur Operating and storage temperature range	$T_{op}; T_{stg}$	- 40 ... + 100	°C
Sperrspannung Reverse voltage	$V_R$	5	V
Durchlaßstrom Forward current	$I_F$	100	mA
Stoßstrom, $\tau \leq 10\ \mu\text{s}$ Surge current	$I_{FSM}$	2.5	A
Verlustleistung Power dissipation	$P_{tot}$	200	mW
Wärmewiderstand, freie Beinchenlänge max. 10 mm Thermal resistance, lead length between package bottom and PC-board max. 10 mm	$R_{thJA}$	375	K/W

**Kennwerte** ( $T_A = 25\text{ °C}$ )**Characteristics**

Bezeichnung Parameter	Symbol Symbol	Wert Value	Einheit Unit
Wellenlänge der Strahlung Wavelength at peak emission $I_F = 100\text{ mA}$	$\lambda_{peak}$	880	nm
Spektrale Bandbreite bei 50% von $I_{max}$ $I_F = 100\text{ mA}$ Spectral bandwidth at 50% of $I_{max}$	$\Delta\lambda$	80	nm
Abstrahlwinkel Half angle	$\varphi$	$\pm 40$	Grad deg.
Aktive Chipfläche Active chip area	$A$	0.09	mm <sup>2</sup>
Abmessungen der aktiven Chipfläche Dimension of the active chip area	$L \times B$ $L \times W$	$0.3 \times 0.3$	mm <sup>2</sup>
Abstand Chipoberfläche bis Gehäusevorderseite Distance chip front to case surface	$H$	0.5 ... 1	mm

**Kennwerte** ( $T_A = 25\text{ °C}$ )  
**Characteristics** (cont'd)

Bezeichnung Parameter	Symbol Symbol	Wert Value	Einheit Unit
Schaltzeiten, $I_e$ von 10% auf 90% und von 90% auf 10%, bei $I_F = 50\text{ mA}$ , $R_L = 50\ \Omega$ Switching times, $I_e$ from 10% to 90% and from 90% to 10%, $I_F = 100\text{ mA}$ , $R_L = 50\ \Omega$	$t_r, t_f$	0.6/0.5	$\mu\text{s}$
Kapazität, $V_R = 0\text{ V}$ , $f = 1\text{ MHz}$ Capacitance	$C_o$	15	pF
Durchlaßspannung, Forward voltage $I_F = 100\text{ mA}$ , $t_p = 20\text{ ms}$ $I_F = 1\text{ A}$ , $t_p = 100\ \mu\text{s}$	$V_F$	1.5 (< 1.8) 3.0 (< 3.8)	V
Sperrstrom, Reverse current $V_R = 5\text{ V}$	$I_R$	0.01 ( $\leq 1$ )	$\mu\text{A}$
Gesamtstrahlungsfluß, Total radiant flux $I_F = 100\text{ mA}$ , $t_p = 20\text{ ms}$	$\Phi_e$	25	mW
Temperaturkoeffizient von $I_e$ bzw. $\Phi_e$ , $I_F = 100\text{ mA}$ Temperature coefficient of $I_e$ or $\Phi_e$ , $I_F = 100\text{ mA}$	$TC_I$	- 0.5	%/K
Temperaturkoeffizient von $V_F$ , $I_F = 100\text{ mA}$ Temperature coefficient of $V_F$ , $I_F = 100\text{ mA}$	$TC_V$	- 2	mV/K
Temperaturkoeffizient von $\lambda$ , $I_F = 100\text{ mA}$ Temperature coefficient of $\lambda$ , $I_F = 100\text{ mA}$	$TC_\lambda$	+ 0.25	nm/K

**Strahlstärke  $I_e$  in Achsrichtung**

gemessen bei einem Raumwinkel  $\Omega = 0.01$  sr

**Radiant Intensity  $I_e$  in Axial Direction**

at a solid angle of  $\Omega = 0.01$  sr

Bezeichnung Parameter	Symbol	Werte Values	Einheit Unit
Strahlstärke Radiant intensity $I_F = 100$ mA, $t_p = 20$ ms	$I_e$	> 3.15	mW/sr
Strahlstärke Radiant intensity $I_F = 1$ A, $t_p = 100$ $\mu$ s	$I_{e \text{ typ.}}$	48	mW/sr

**Relative Spectral Emission**

$I_{rel} = f(\lambda)$

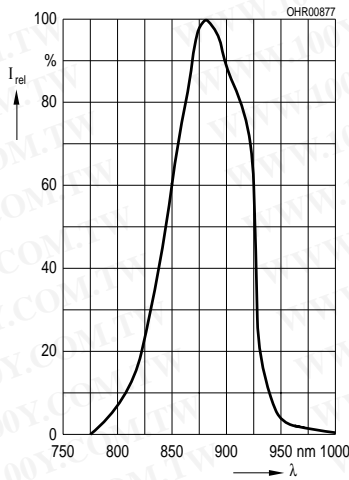

**Radiant Intensity**  $\frac{I_e}{I_e 100 \text{ mA}} = f(I_F)$

Single pulse,  $t_p = 20 \mu\text{s}$

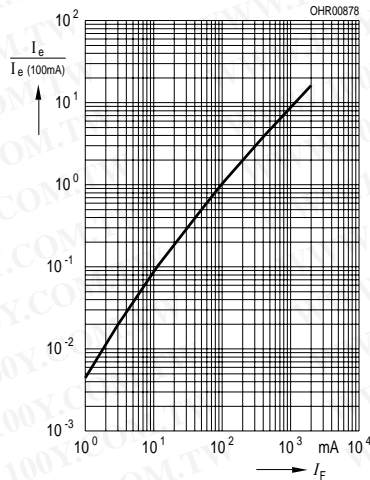

**Max. Permissible Forward Current**

$I_F = f(T_A)$

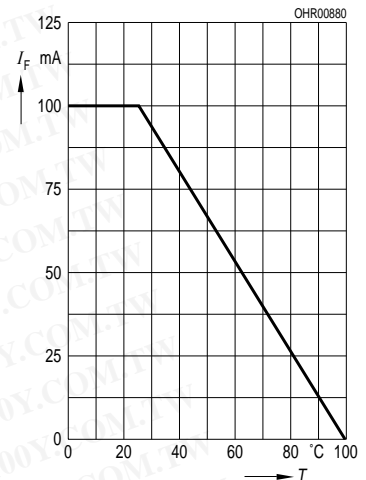

**Forward Current**

$I_F = f(V_F)$ , Single pulse,  $t_p = 20 \mu\text{s}$

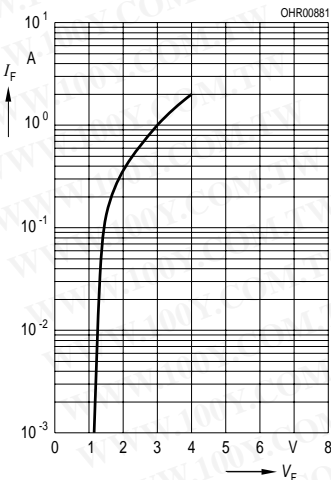

**Permissible Pulse Handling Capability**

$I_F = f(\tau)$ ,  $T_A = 25^\circ\text{C}$ , duty cycle  $D = \text{parameter}$

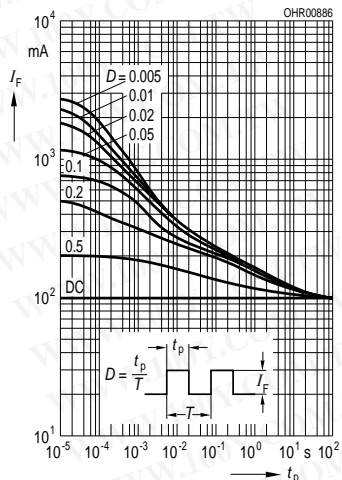

**Forward Current vs. Lead Length Between the Package Bottom and the PC-Board**

$I_F = f(l)$ ,  $T_A = 25^\circ\text{C}$

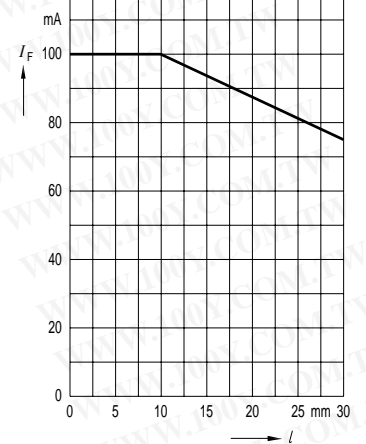

**Radiation Characteristics**  $I_{rel} = f(\varphi)$

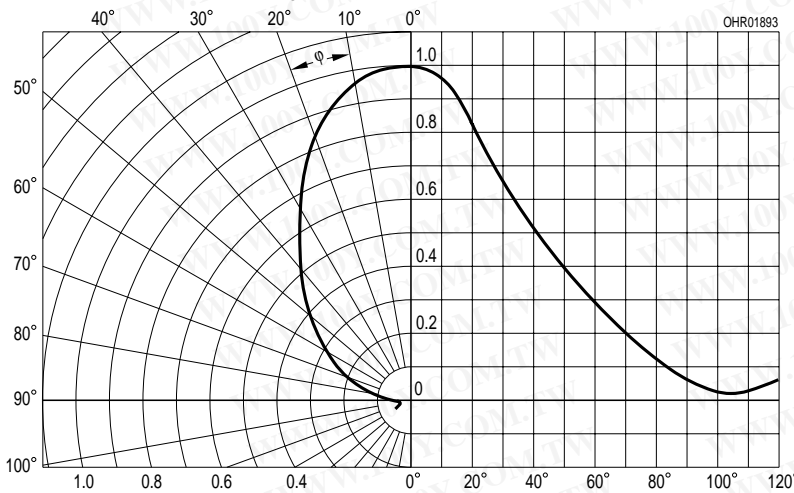

勝特力材料 886-3-5753170  
 勝特力电子(上海) 86-21-54151736  
 勝特力电子(深圳) 86-755-83298787  
[Http://www.100y.com.tw](http://www.100y.com.tw)

**Maßzeichnung  
Package Outlines**

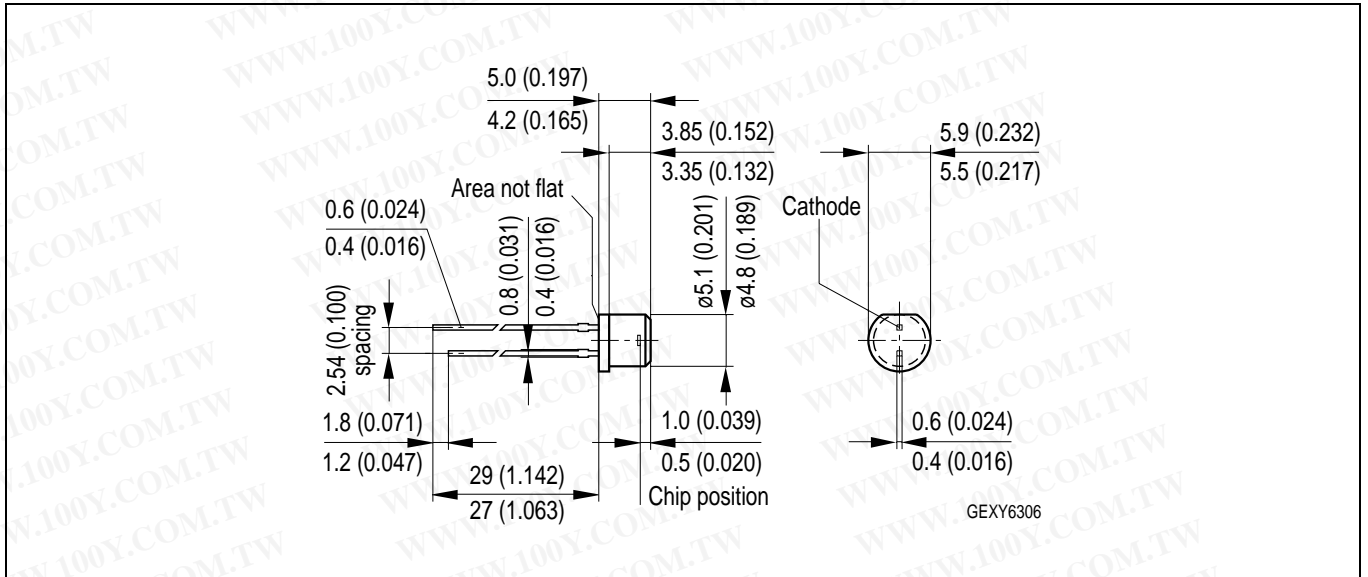

Maße in mm (inch) / Dimensions in mm (inch).

**Empfohlenes Lötpaddesign  
Recommended Solder Pad**

**Wellenlöten (TTW)  
TTW Soldering**

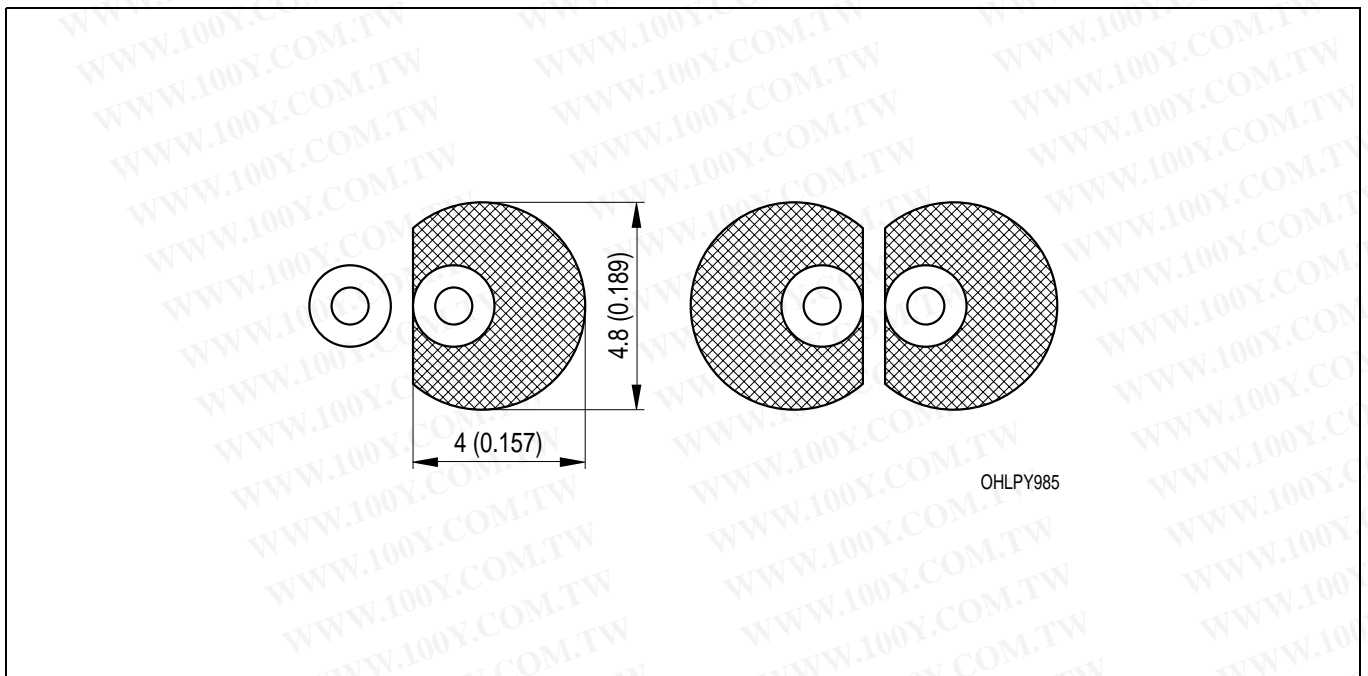

Maße in mm (inch) / Dimensions in mm (inch).

**Lötbedingungen**  
**Soldering Conditions**  
**Wellenlöten (TTW)**  
**TTW Soldering**

(nach CECC 00802)  
(acc. to CECC 00802)

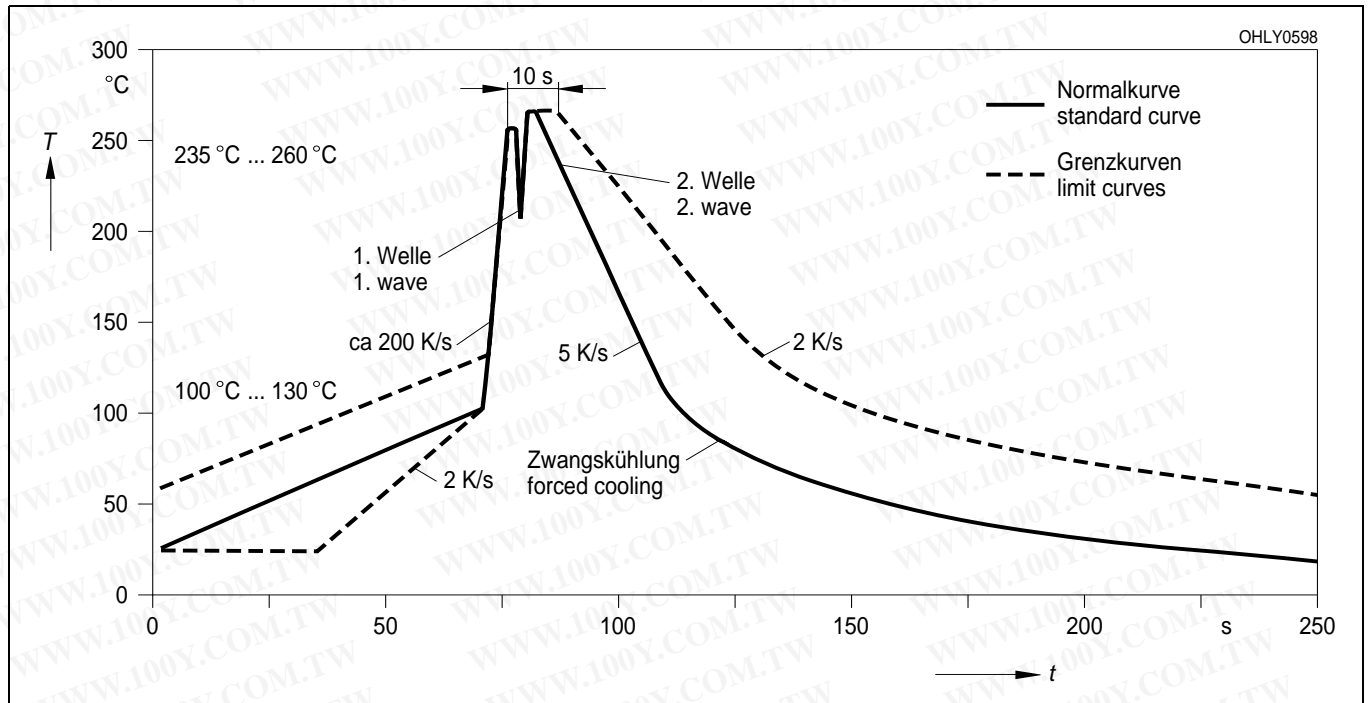

Published by  
**OSRAM Opto Semiconductors GmbH**  
Wernerwerkstrasse 2, D-93049 Regensburg  
© All Rights Reserved.

The information describes the type of component and  
Terms of delivery and rights to change design reserved. Due to technical requirements components may contain  
dangerous substances. For information on the types in question please contact our Sales Organization.

**Packing**

Please use the recycling operators known to you. We can also help you – get in touch with your nearest sales office.  
By agreement we will take packing material back, if it is sorted. You must bear the costs of transport. For packing  
material that is returned to us unsorted or which we are not obliged to accept, we shall have to invoice you for any costs  
incurred.

**Components used in life-support devices or systems must be expressly authorized for such purpose!** Critical  
components <sup>1</sup>, may only be used in life-support devices or systems <sup>2</sup> with the express written approval of OSRAM OS.

<sup>1</sup> A critical component is a component used in a life-support device or system whose failure can reasonably be expected  
to cause the failure of that life-support device or system, or to affect its safety or effectiveness of that device or system.

<sup>2</sup> Life support devices or systems are intended (a) to be implanted in the human body, or (b) to support and/or maintain  
and sustain human life. If they fail, it is reasonable to assume that the health of the user may be endangered.

EU RoHS and China RoHS compliant product



此产品符合欧盟 RoHS 指令的要求；

按照中国的相关法规和标准，不含有毒有害物质或元素。