

# NL17SZ14

勝特力材料 886-3-5753170  
 勝特力电子(上海) 86-21-54151736  
 勝特力电子(深圳) 86-755-83298787  
[Http://www.100y.com.tw](http://www.100y.com.tw)



**ON Semiconductor**<sup>®</sup>

<http://onsemi.com>

## Single Inverter with Schmitt Trigger

The NL17SZ14 is a single inverter with Schmitt trigger in two tiny footprint packages. The device performs much as LCX multi-gate products in speed and drive.

### Features

- Tiny SOT-353 and SOT-553 Packages
- Source/Sink 24 mA at 3.0 V
- Over-Voltage Tolerant Inputs and Outputs
- Pin For Pin with NC7SZ14
- Designed for 1.65 V to 5.5 V  $V_{CC}$  Operation
- Chip Complexity: FET = 20
- Pb-Free Packages are Available

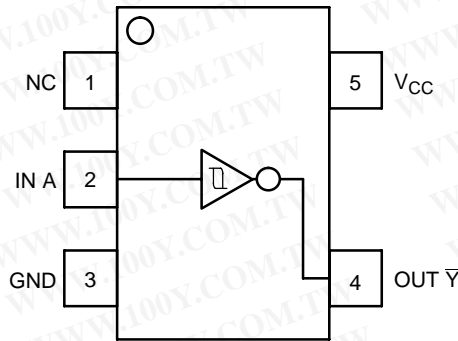

Figure 1. Pinout

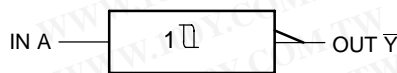
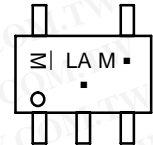

Figure 2. Logic Symbol

### MARKING DIAGRAMS



SOT-353/SC70-5/SC-88A  
 DF SUFFIX  
 CASE 419A



SOT-553  
 XV5 SUFFIX  
 CASE 463B

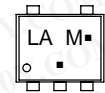

LA = Device Code  
 M = Date Code\*  
 A = Assembly Location  
 Y = Year  
 W = Work Week  
 ■ = Pb-Free Package  
 (Note: Microdot may be in either location)

\*Date Code orientation and/or position may vary depending upon manufacturing location.

PIN ASSIGNMENT	
1	NC
2	IN A
3	GND
4	OUT $\bar{Y}$
5	$V_{CC}$

A Input	$\bar{Y}$ Output
L	H
H	L

### ORDERING INFORMATION

See detailed ordering and shipping information in the package dimensions section on page 4 of this data sheet.

# NL17SZ14

## MAXIMUM RATINGS

Symbol	Characteristics	Value	Unit
V <sub>CC</sub>	DC Supply Voltage	-0.5 to +7.0	V
V <sub>I</sub>	DC Input Voltage	-0.5 ≤ V <sub>I</sub> ≤ +7.0	V
V <sub>O</sub>	DC Output Voltage Output in High or LOW State (Note 1)	-0.5 ≤ V <sub>O</sub> ≤ 7.0	V
I <sub>IK</sub>	DC Input Diode Current V <sub>I</sub> < GND	-50	mA
I <sub>OK</sub>	DC Output Diode Current V <sub>O</sub> < GND	-50	mA
I <sub>O</sub>	DC Output Sink Current	±50	mA
I <sub>CC</sub>	DC Supply Current per Supply Pin	±100	mA
I <sub>GND</sub>	DC Ground Current per Ground Pin	±100	mA
T <sub>STG</sub>	Storage Temperature Range	-65 to +150	°C
P <sub>D</sub>	Power Dissipation in Still Air SOT-353 SOT-553	186 135	mW
θ <sub>JA</sub>	Thermal Resistance SOT-353 SOT-553	350 496	°C/W
T <sub>L</sub>	Lead Temperature, 1 mm from Case for 10 Seconds	260	°C
T <sub>J</sub>	Junction Temperature under Bias	+150	°C
MSL	Moisture Sensitivity	Level 1	
F <sub>R</sub>	Flammability Rating Oxygen Index: 28 to 34	UL 94 V-0 @ 0.125 in	
ESD	ESD Classification Human Body Model (Note 2) Machine Model (Note 3) Charged Device Model (Note 4)	Class 2 Class C N/A	

Maximum ratings are those values beyond which device damage can occur. Maximum ratings applied to the device are individual stress limit values (not normal operating conditions) and are not valid simultaneously. If these limits are exceeded, device functional operation is not implied, damage may occur and reliability may be affected.

1. Measured with minimum pad spacing on an FR4 board, using 10 mm-by-1 inch, 2-ounce copper trace with no air flow.
2. Tested to EIA/JESD22-A114-A, rated to EIA/JESD22-A114-B.
3. Tested to EIA/JESD22-A115-A, rated to EIA/JESD22-A115-A.
4. Tested to JESD22-C101-A.

## RECOMMENDED OPERATING CONDITIONS

Symbol	Parameter	Min	Max	Unit
V <sub>CC</sub>	Supply Voltage Operating Data Retention Only	1.65 1.5	5.5 5.5	V
V <sub>I</sub>	Input Voltage	0	5.5	V
V <sub>O</sub>	Output Voltage (High or LOW State)	0	5.5	V
T <sub>A</sub>	Operating Free-Air Temperature	-40	+85	°C
Δt/ΔV	Input Transition Rise or Fall Rate V <sub>CC</sub> = 2.5 V ± 0.2 V V <sub>CC</sub> = 3.0 V ± 0.3 V V <sub>CC</sub> = 5.0 V ± 0.5 V	0 0 0	No Limit No Limit No Limit	ns/V

勝特力材料 886-3-5753170  
 勝特力电子(上海) 86-21-54151736  
 勝特力电子(深圳) 86-755-83298787  
[Http://www.100y.com.tw](http://www.100y.com.tw)

# NL17SZ14

## DC ELECTRICAL CHARACTERISTICS

Symbol	Parameter	Condition	V <sub>CC</sub> (V)	T <sub>A</sub> = 25°C			-40°C ≤ T <sub>A</sub> ≤ 85°C		Unit
				Min	Typ	Max	Min	Max	
V <sub>T+</sub>	Positive Input Threshold Voltage		1.65	0.6	1.0	1.4	0.6	1.4	V
			2.3	1.0	1.5	1.8	1.0	1.8	
			2.7	1.2	1.7	2.0	1.2	2.0	
			3.0	1.3	1.9	2.2	1.3	2.2	
			4.5	1.9	2.7	3.1	1.9	3.1	
			5.5	2.2	3.3	3.6	2.2	3.6	
V <sub>T-</sub>	Negative Input Threshold Voltage		1.65	0.2	0.5	0.8	0.2	0.8	V
			2.3	0.4	0.75	1.15	0.4	1.15	
			2.7	0.5	0.87	1.4	0.5	1.4	
			3.0	0.6	1.0	1.5	0.6	1.5	
			4.5	1.0	1.5	2.0	1.0	2.0	
			5.5	1.2	1.9	2.3	1.2	2.3	
V <sub>H</sub>	Input Hysteresis Voltage		1.65	0.1	0.48	0.9	0.1	0.9	V
			2.3	0.25	0.75	1.1	0.25	1.1	
			2.7	0.3	0.83	1.15	0.3	1.15	
			3.0	0.4	0.93	1.2	0.4	1.2	
			4.5	0.6	1.2	1.5	0.6	1.5	
			5.5	0.7	1.4	1.7	0.7	1.7	
V <sub>OH</sub>	High-Level Output Voltage V <sub>IN</sub> = V <sub>IH</sub> or V <sub>IL</sub>	I <sub>OH</sub> = -100 μA	1.65 to 5.5	V <sub>CC</sub> - 0.1	V <sub>CC</sub>	V <sub>CC</sub> - 0.1		V	
		I <sub>OH</sub> = -3 mA	1.65	1.29	1.52	1.29			
		I <sub>OH</sub> = -8 mA	2.3	1.9	2.1	1.9			
		I <sub>OH</sub> = -12 mA	2.7	2.2	2.4	2.2			
		I <sub>OH</sub> = -16 mA	3.0	2.4	2.7	2.4			
		I <sub>OH</sub> = -24 mA	3.0	2.3	2.5	2.3			
		I <sub>OH</sub> = -32 mA	4.5	3.8	4.0	3.8			
V <sub>OL</sub>	Low-Level Output Voltage V <sub>IN</sub> = V <sub>IH</sub> or V <sub>IL</sub>	I <sub>OL</sub> = 100 μA	1.65 to 5.5		0.0	0.1	0.1	V	
		I <sub>OL</sub> = 4 mA	1.65		0.08	0.24	0.24		
		I <sub>OL</sub> = 8 mA	2.3		0.2	0.3	0.3		
		I <sub>OL</sub> = 12 mA	2.7		0.22	0.4	0.4		
		I <sub>OL</sub> = 16 mA	3.0		0.28	0.4	0.4		
		I <sub>OL</sub> = 24 mA	3.0		0.38	0.55	0.55		
		I <sub>OL</sub> = 32 mA	4.5		0.42	0.55	0.55		
I <sub>IN</sub>	Input Leakage Current	V <sub>IN</sub> = V <sub>CC</sub> or GND	0 to 5.5			±0.1	±1.0	μA	
I <sub>OFF</sub>	Power Off-Output Leakage Current	V <sub>OUT</sub> = 5.5 V	0			1	10	μA	
I <sub>CC</sub>	Quiescent Supply Current	V <sub>IN</sub> = V <sub>CC</sub> or GND	5.5			1	10	μA	

**勝特力材料 886-3-5753170**  
**勝特力电子(上海) 86-21-54151736**  
**勝特力电子(深圳) 86-755-83298787**  
[Http://www.100y.com.tw](http://www.100y.com.tw)

# NL17SZ14

## AC ELECTRICAL CHARACTERISTICS $t_R = t_F = 3.0$ ns

Symbol	Parameter	Condition	V <sub>CC</sub> (V)	T <sub>A</sub> = 25°C			-40°C ≤ T <sub>A</sub> ≤ 85°C		Unit
				Min	Typ	Max	Min	Max	
t <sub>PLH</sub> t <sub>PHL</sub>	Propagation Delay (Figure 3 and 4)	R <sub>L</sub> = 1 MΩ, C <sub>L</sub> = 15 pF	1.65	2.0	9.1	15	2.0	15.6	ns
			1.8	2.0	7.6	12.5	2.0	13	
			2.5 ± 0.2	1.0	5.0	9.0	1.0	9.5	
		3.3 ± 0.3	1.0	3.7	6.3	1.0	6.5		
		5.0 ± 0.5	0.5	3.1	5.2	0.5	5.5		
		R <sub>L</sub> = 500 Ω, C <sub>L</sub> = 50 pF	3.3 ± 0.3	1.5	4.4	7.2	1.5	7.5	
5.0 ± 0.5	0.8		3.7	5.9	0.8	6.2			

## CAPACITIVE CHARACTERISTICS

Symbol	Parameter	Condition	Typical	Unit
C <sub>IN</sub>	Input Capacitance	V <sub>CC</sub> = 5.5 V, V <sub>I</sub> = 0 V or V <sub>CC</sub>	> 4.0	pF
C <sub>PD</sub>	Power Dissipation Capacitance (Note 5)	10 MHz, V <sub>CC</sub> = 3.3 V, V <sub>I</sub> = 0 V or V <sub>CC</sub> 10 MHz, V <sub>CC</sub> = 5.5 V, V <sub>I</sub> = 0 V or V <sub>CC</sub>	25 30	pF

5. C<sub>PD</sub> is defined as the value of the internal equivalent capacitance which is calculated from the operating current consumption without load. Average operating current can be obtained by the equation: I<sub>CC(OPR)</sub> = C<sub>PD</sub> • V<sub>CC</sub> • f<sub>in</sub> + I<sub>CC</sub>. C<sub>PD</sub> is used to determine the no-load dynamic power consumption; P<sub>D</sub> = C<sub>PD</sub> • V<sub>CC</sub><sup>2</sup> • f<sub>in</sub> + I<sub>CC</sub> • V<sub>CC</sub>.

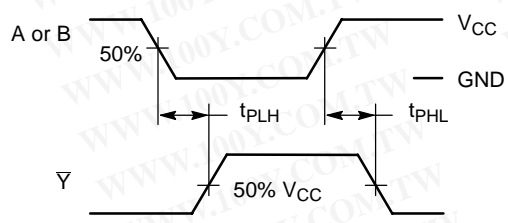
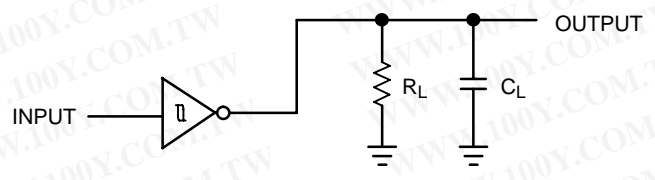

Figure 3. Switching Waveform



A 1-MHz square input wave is recommended for propagation delay tests.

Figure 4. Test Circuit

勝特力材料 886-3-5753170  
 勝特力电子(上海) 86-21-54151736  
 勝特力电子(深圳) 86-755-83298787  
[Http://www.100y.com.tw](http://www.100y.com.tw)

## DEVICE ORDERING INFORMATION

Device Order Number	Package Type	Tape and Reel Size†
NL17SZ14DFT2	SOT-353/SC70-5/SC-88A	3000 / Tape & Reel
NL17SZ14DFT2G	SOT-353/SC70-5/SC-88A (Pb-Free)	3000 / Tape & Reel
NL17SZ14XV5T2	SOT-553*	3000 / Tape & Reel
NL17SZ14XV5T2G	SOT-553*	3000 / Tape & Reel

†For information on tape and reel specifications, including part orientation and tape sizes, please refer to our Tape and Reel Packaging Specifications Brochure, BRD8011/D.

\*All Devices in Package SOT553 are Inherently Pb-Free.

# NL17SZ14

## PACKAGE DIMENSIONS

SC-88A, SOT-353, SC-70  
CASE 419A-02  
ISSUE J

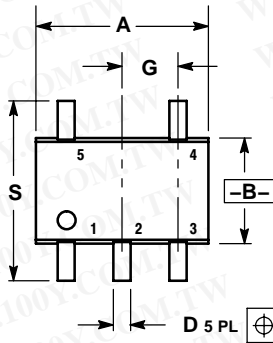

勝特力材料 886-3-5753170  
勝特力电子(上海) 86-21-54151736  
勝特力电子(深圳) 86-755-83298787  
[Http://www.100y.com.tw](http://www.100y.com.tw)

D 5 PL  $\oplus$  0.2 (0.008) (M) B (M)

NOTES:

1. DIMENSIONING AND TOLERANCING PER ANSI Y14.5M, 1982.
2. CONTROLLING DIMENSION: INCH.
3. 419A-01 OBSOLETE. NEW STANDARD 419A-02.
4. DIMENSIONS A AND B DO NOT INCLUDE MOLD FLASH, PROTRUSIONS, OR GATE BURRS.

DIM	INCHES		MILLIMETERS	
	MIN	MAX	MIN	MAX
A	0.071	0.087	1.80	2.20
B	0.045	0.053	1.15	1.35
C	0.031	0.043	0.80	1.10
D	0.004	0.012	0.10	0.30
G	0.026 BSC		0.65 BSC	
H	---	0.004	---	0.10
J	0.004	0.010	0.10	0.25
K	0.004	0.012	0.10	0.30
N	0.008 REF		0.20 REF	
S	0.079	0.087	2.00	2.20

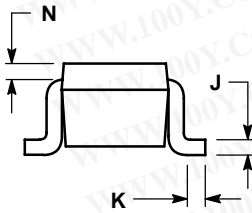
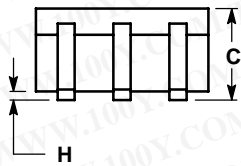

### SOLDERING FOOTPRINT\*

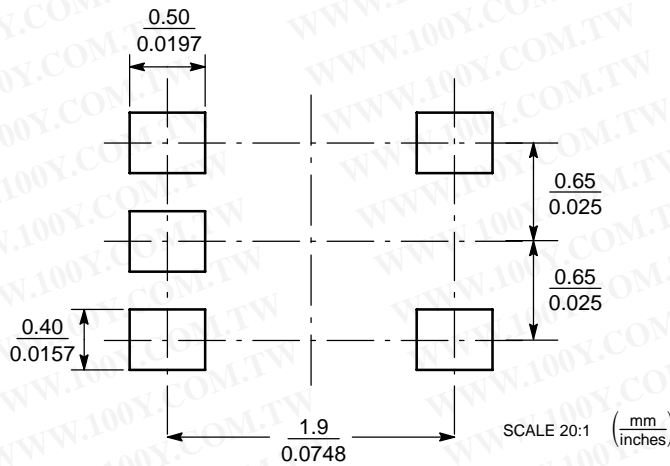

\*For additional information on our Pb-Free strategy and soldering details, please download the ON Semiconductor Soldering and Mounting Techniques Reference Manual, SOLDERRM/D.

# NL17SZ14

## PACKAGE DIMENSIONS

SOT-553, 5 LEAD  
CASE 463B-01  
ISSUE B

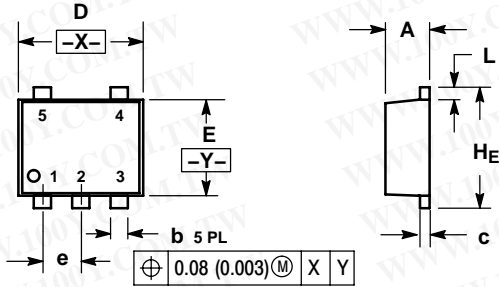

NOTES:

1. DIMENSIONING AND TOLERANCING PER ANSI Y14.5M, 1982.
2. CONTROLLING DIMENSION: MILLIMETERS
3. MAXIMUM LEAD THICKNESS INCLUDES LEAD FINISH THICKNESS. MINIMUM LEAD THICKNESS IS THE MINIMUM THICKNESS OF BASE MATERIAL.

DIM	MILLIMETERS			INCHES		
	MIN	NOM	MAX	MIN	NOM	MAX
A	0.50	0.55	0.60	0.020	0.022	0.024
b	0.17	0.22	0.27	0.007	0.009	0.011
c	0.08	0.13	0.18	0.003	0.005	0.007
D	1.50	1.60	1.70	0.059	0.063	0.067
E	1.10	1.20	1.30	0.043	0.047	0.051
e	0.50 BSC			0.020 BSC		
L	0.10	0.20	0.30	0.004	0.008	0.012
HE	1.50	1.60	1.70	0.059	0.063	0.067

### SOLDERING FOOTPRINT\*

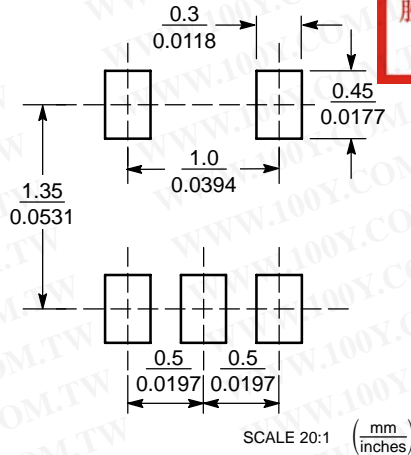

勝特力材料 886-3-5753170  
勝特力电子(上海) 86-21-54151736  
勝特力电子(深圳) 86-755-83298787  
[Http://www.100y.com.tw](http://www.100y.com.tw)

\*For additional information on our Pb-Free strategy and soldering details, please download the ON Semiconductor Soldering and Mounting Techniques Reference Manual, SOLDERRM/D.

ON Semiconductor and are registered trademarks of Semiconductor Components Industries, LLC (SCILLC). SCILLC reserves the right to make changes without further notice to any products herein. SCILLC makes no warranty, representation or guarantee regarding the suitability of its products for any particular purpose, nor does SCILLC assume any liability arising out of the application or use of any product or circuit, and specifically disclaims any and all liability, including without limitation special, consequential or incidental damages. "Typical" parameters which may be provided in SCILLC data sheets and/or specifications can and do vary in different applications and actual performance may vary over time. All operating parameters, including "Typicals" must be validated for each customer application by customer's technical experts. SCILLC does not convey any license under its patent rights nor the rights of others. SCILLC products are not designed, intended, or authorized for use as components in systems intended for surgical implant into the body, or other applications intended to support or sustain life, or for any other application in which the failure of the SCILLC product could create a situation where personal injury or death may occur. Should Buyer purchase or use SCILLC products for any such unintended or unauthorized application, Buyer shall indemnify and hold SCILLC and its officers, employees, subsidiaries, affiliates, and distributors harmless against all claims, costs, damages, and expenses, and reasonable attorney fees arising out of, directly or indirectly, any claim of personal injury or death associated with such unintended or unauthorized use, even if such claim alleges that SCILLC was negligent regarding the design or manufacture of the part. SCILLC is an Equal Opportunity/Affirmative Action Employer. This literature is subject to all applicable copyright laws and is not for resale in any manner.

### PUBLICATION ORDERING INFORMATION

LITERATURE FULFILLMENT:  
Literature Distribution Center for ON Semiconductor  
P.O. Box 61312, Phoenix, Arizona 85082-1312 USA  
Phone: 480-829-7710 or 800-344-3860 Toll Free USA/Canada  
Fax: 480-829-7709 or 800-344-3867 Toll Free USA/Canada  
Email: [orderlit@onsemi.com](mailto:orderlit@onsemi.com)

N. American Technical Support: 800-282-9855 Toll Free  
USA/Canada

Japan: ON Semiconductor, Japan Customer Focus Center  
2-9-1 Kamimeguro, Meguro-ku, Tokyo, Japan 153-0051  
Phone: 81-3-5773-3850

ON Semiconductor Website: <http://onsemi.com>

Order Literature: <http://www.onsemi.com/litorder>

For additional information, please contact your local Sales Representative.