

Power Solid-state Relay

G3PA-(VD)

Extremely Thin Relays Integrated with Heat Sink

勝特力材料 886-3-5753170
 勝特力电子(上海) 86-21-54151736
 勝特力电子(深圳) 86-755-83298787
[Http://www.100y.com.tw](http://www.100y.com.tw)

- Downsizing achieved through optimum design of heat sink.
- Mounting possible via screws or via DIN rail.
- Dense mounting possible for linking terminals. (Except for G3PA-260B-VD.)
- Applicable with 3-phase loads.
- Replaceable power element cartridges.
- Conforms to VDE 0160 (finger protection), with a dielectric strength of 4,000 V between input and load. (see note)
- Conforms to VDE 0805, IEC 950. (see note)

Note: G3PA-420B-VD/-430B-VD are under application for standard approval.



Ordering Information

Model	Isolation	Zero cross function	Indicator	Applicable output load	Rated input voltage	
G3PA-210B-VD	Phototriac coupler	Yes	Yes	10 A at 24 to 240 VAC	5 to 24 VDC	
G3PA-220B-VD				20 A at 24 to 240 VAC		
G3PA-240B-VD				40 A at 24 to 240 VAC		
G3PA-260B-VD				60 A at 24 to 240 VAC		
G3PA-210BL-VD		No			10 A at 24 to 240 VAC	
G3PA-220BL-VD					20 A at 24 to 240 VAC	
G3PA-240BL-VD					40 A at 24 to 240 VAC	
G3PA-260BL-VD					60 A at 24 to 240 VAC	
G3PA-210B-VD	Yes			10 A at 24 to 240 VAC	24 VAC	
G3PA-220B-VD				20 A at 24 to 240 VAC		
G3PA-240B-VD				40 A at 24 to 240 VAC		
G3PA-260B-VD				60 A at 24 to 240 VAC		
G3PA-420B-VD				20 A at 200 to 400 VAC	12 to 24 VDC	
G3PA-430B-VD	30 A at 200 to 400 VAC					

Replacement Parts

Name	Carry current	Model	Applicable SSR
Power Device Cartridge	10 A	G32A-A10-VD DC5-24	G3PA-210B-VD DC5-24
		G32A-A10L-VD DC5-24	G3PA-210BL-VD DC5-24
		G32A-A10-VD AC24	G3PA-210B-VD AC24
	20 A	G32A-A20-VD DC5-24	G3PA-220B-VD DC5-24
		G32A-A20L-VD DC5-24	G3PA-220BL-VD DC5-24
		G32A-A20-VD AC24	G3PA-220B-VD AC24
	40 A	G32A-A40-VD DC5-24	G3PA-240B-VD DC5-24
		G32A-A40L-VD DC5-24	G3PA-240BL-VD DC5-24
		G32A-A40-VD AC24	G3PA-240B-VD AC24
	60 A	G32A-A60-VD DC5-24	G3PA-260B-VD DC5-24
		G32A-A60L-VD DC5-24	G3PA-260BL-VD DC5-24
		G32A-A60-VD AC24	G3PA-260B-VD AC24
	20 A		G32A-A420-VD DC12-24
30 A		G32A-A430-VD DC12-24	G3PA-430B-VD DC12-24

Specifications

■ Ratings (at 25°C)

Input

勝特力材料 886-3-5753170
 勝特力电子(上海) 86-21-54151736
 勝特力电子(深圳) 86-755-83298787
[Http://www.100y.com.tw](http://www.100y.com.tw)

Model	Rated voltage	Voltage range	Input current impedance	Voltage level	
				Must operate voltage	Must release voltage
G3PA-210B-VD	5 to 24 VDC	4 to 30 VDC	7 mA max.	4 VDC max.	1 VDC min.
G3PA-220B-VD					
G3PA-240B-VD					
G3PA-260B-VD					
G3PA-210BL-VD	5 to 24 VDC	4 to 30 VDC	20 mA max.	4 VDC max.	1 VDC min.
G3PA-220BL-VD					
G3PA-240BL-VD					
G3PA-260BL-VD					
G3PA-210B-VD	24 VAC	19.2 to 26.4 VAC	1.4 kΩ±20%	19.2 VAC max.	4.8 VAC min.
G3PA-220B-VD					
G3PA-240B-VD					
G3PA-260B-VD					
G3PA-420B-VD	12 to 24 VDC	9.6 to 30 VDC	7 mA max.	9.6 VDC max.	1 VDC min.
G3PA-430B-VD					

Output

Model	Applicable load		
	Load voltage	Load current	Inrush current
G3PA-210B(L)-VD	19 to 264 VAC (50/60 Hz)	0.1 to 10 A	150 A (60 Hz, 1 cycle)
G3PA-220B(L)-VD		0.1 to 20 A	220 A (60 Hz, 1 cycle)
G3PA-240B(L)-VD		0.5 to 40 A	440 A (60 Hz, 1 cycle)
G3PA-260B(L)-VD		0.5 to 60 A	440 A (60 Hz, 1 cycle)
G3PA-420B-VD	180 to 440 VDC (50/60 Hz)	0.5 to 20 A	220 A (60 Hz, 1 cycle)
G3PA-430B-VD		0.5 to 30 A	440 A (60 Hz, 1 cycle)

Refer to *Engineering Data* for further details.

■ Characteristics

Item	G3PA-210B(L)-VD	G3PA-220B(L)-VD	G3PA-240B(L)-VD	G3PA-260B(L)-VD	G3PA-420B-VD	G3PA-430B-VD
Operate time	1/2 of load power source cycle + 1 ms max. (DC Input, -B models) 1 1/2 of load power source cycle + 1 ms max. (AC Input) 1 ms max. (-BL models)					
Release time	1/2 of load power source cycle + 1 ms max. (DC Input) 1 1/2 of load power source cycle + 1 ms max. (AC Input)					
Output ON voltage drop	1.6 V (RMS) max.				1.8 V (RMS) max.	
Leakage current	5 mA max. (at 120 VAC) 10 mA max. (at 230 VAC)		10 mA max. (at 120 VAC) 20 mA max. (at 230 VAC)		20 mA max. (at 400 VAC)	
I ² t	260 A ² S		810 A ² S		260 A ² S	810 A ² S
Insulation resistance	100 MΩ min. (at 500 VDC)					
Dielectric strength	4,000 VAC, 50/60 Hz for 1 min					
Vibration resistance	Malfunction: 10 to 55 Hz, 0.75-mm double amplitude (mounted to DIN rail)					
Shock resistance	Malfunction: 300 m/s ² (approx. 30G) (mounted to DIN rail)					
Ambient temperature	Operating: -30°C to 80°C (with no icing) Storage: -30°C to 100°C (with no icing)					
Ambient humidity	Operating: 45% to 85%					
Weight	Approx. 260 g	Approx. 340 g	Approx. 460 g	Approx. 900 g	Approx. 380 g	Approx. 500 g

Engineering Data

Load Current vs. Ambient Temperature Characteristics

Horizontal Mounting to Ground

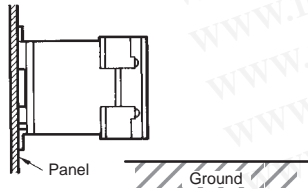

勝特力材料 886-3-5753170
 勝特力电子(上海) 86-21-54151736
 勝特力电子(深圳) 86-755-83298787
[Http://www.100y.com.tw](http://www.100y.com.tw)

G3PA-210B(L)-VD, G3PA-220B(L)-VD

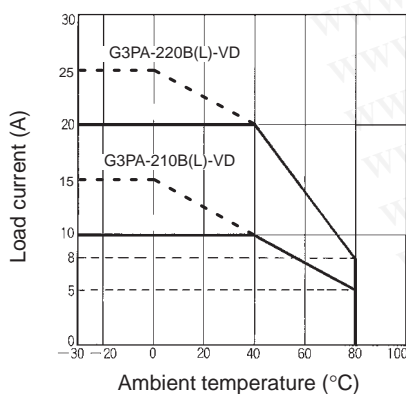

G3PA-240B(L)-VD

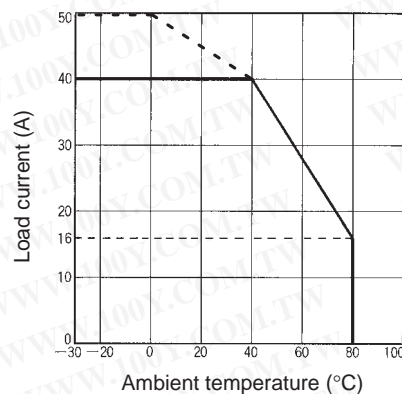

G3PA-260B(L)-VD

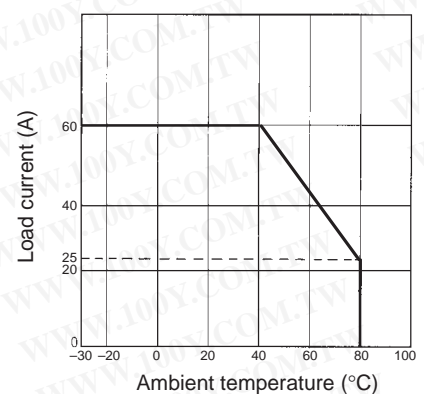

G3PA-420B-VD

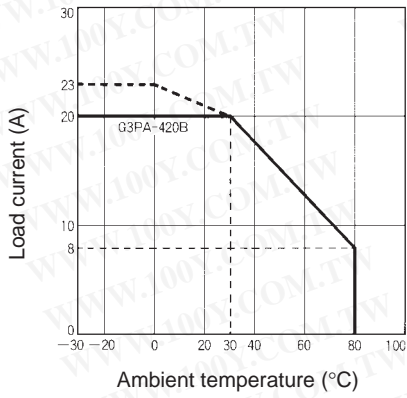

G3PA-430B-VD

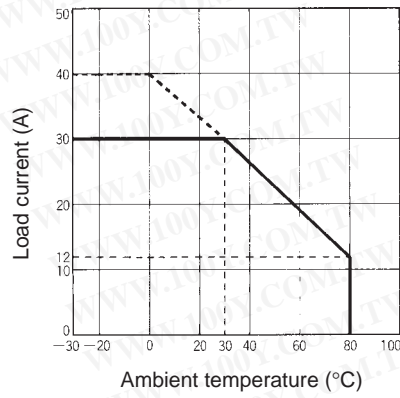

勝特力材料 886-3-5753170
 勝特力电子(上海) 86-21-54151736
 勝特力电子(深圳) 86-755-83298787
[Http://www.100y.com.tw](http://www.100y.com.tw)

Note: Dense mounting is possible for a maximum of three Units by reducing the load current by 20%. (A minimum clearance of 10 mm must be provided when mounting four or more Units.)

Characteristics Between Input Voltage and Input Current

G3PA-2□0B-VD

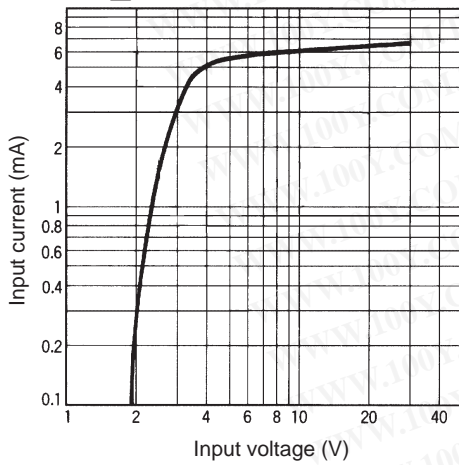

G3PA-4□B-VD

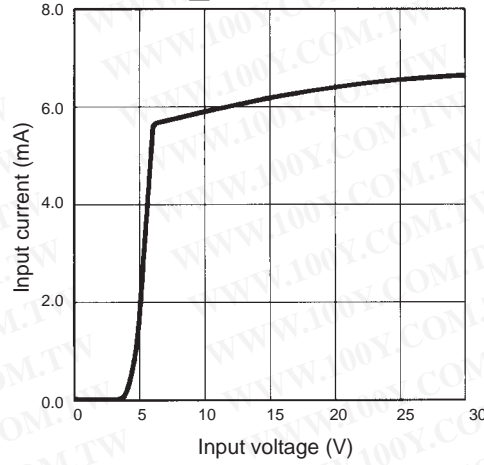

Vertical Mounting to Ground

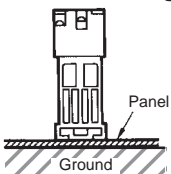

G3PA-210B(L)-VD, G3PA-220B(L)-VD

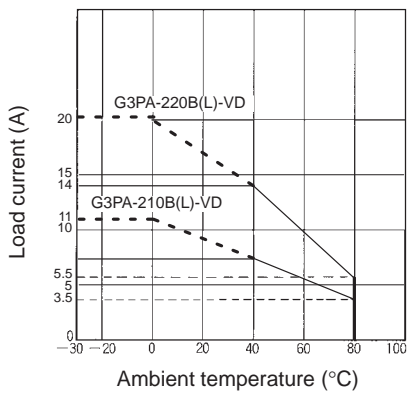

G3PA-240B(L)-VD

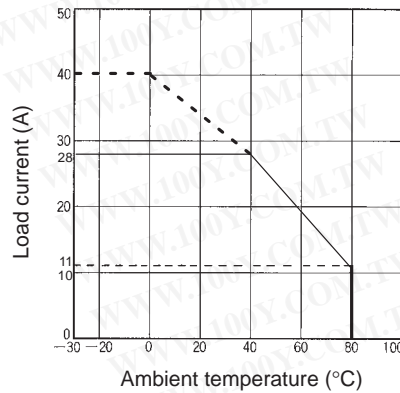

G3PA-260B(L)-VD

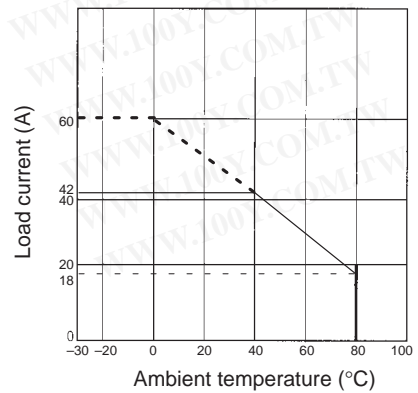

G3PA-420B-VD, G3PA-430B-VD

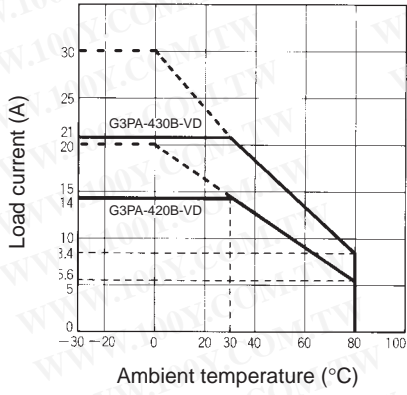

勝特力材料 886-3-5753170
 勝特力电子(上海) 86-21-54151736
 勝特力电子(深圳) 86-755-83298787
[Http://www.100y.com.tw](http://www.100y.com.tw)

Dense Mounting Side-by-side (Up to Three)

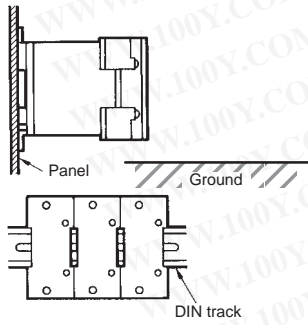

G3PA-210B(L)-VD, G3PA-220B(L)-VD

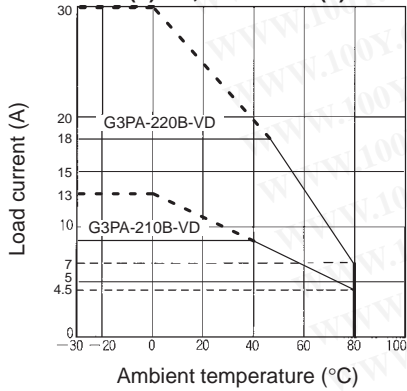

G3PA-240B(L)-VD

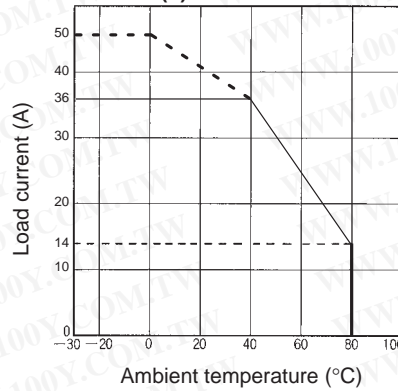

G3PA-260B(L)-VD

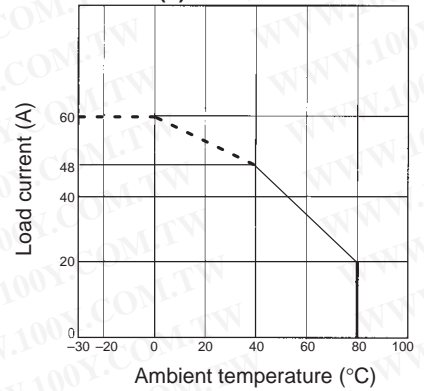

G3PA-420B-VD

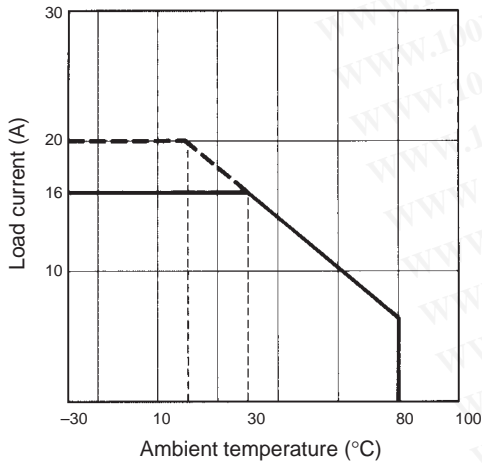

G3PA-430B-VD

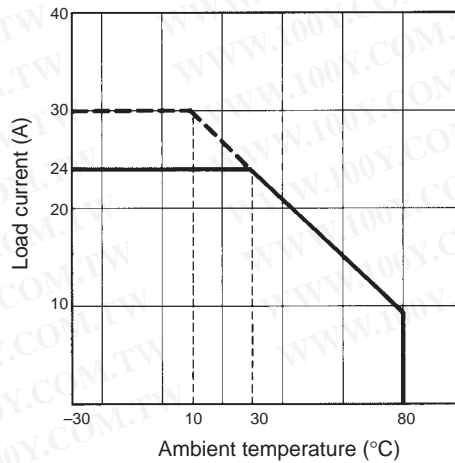

Inrush Current Resistivity

Non-repetitive (Keep the inrush current to half the rated value if it occurs repetitively.)

G3PA-210B(L)-VD

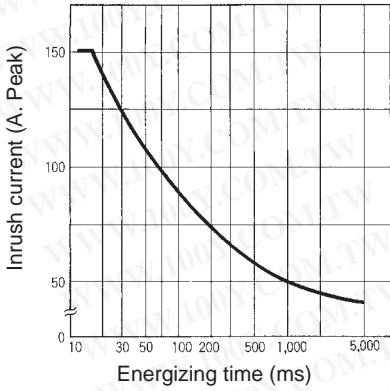

G3PA-220B(L)-VD

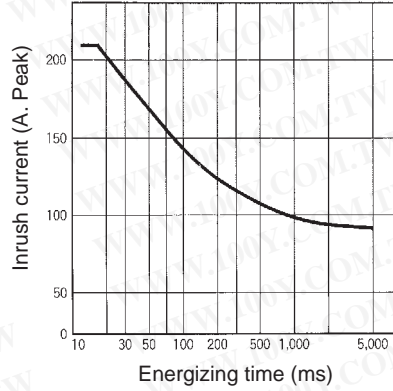

G3PA-240B(L)-VD/260B(L)-VD

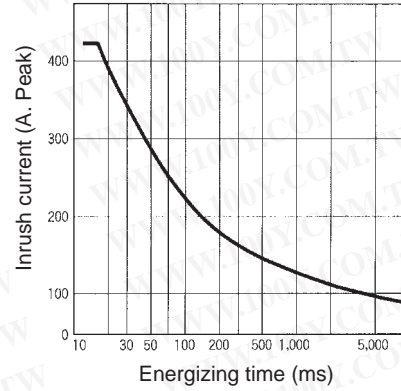

G3PA-420B-VD

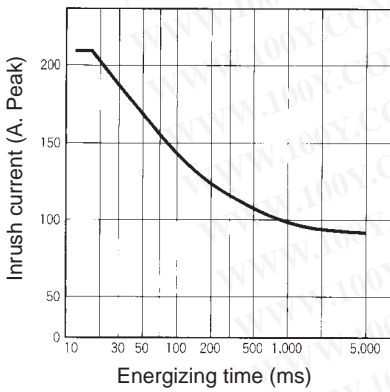

G3PA-430B-VD

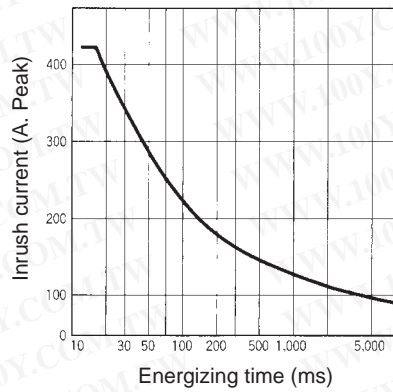

勝特力材料 886-3-5753170
勝特力电子(上海) 86-21-54151736
勝特力电子(深圳) 86-755-83298787
[Http://www.100y.com.tw](http://www.100y.com.tw)

Nomenclature

勝特力材料 886-3-5753170
 勝特力电子(上海) 86-21-54151736
 勝特力电子(深圳) 86-755-83298787
[Http://www.100y.com.tw](http://www.100y.com.tw)

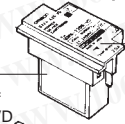
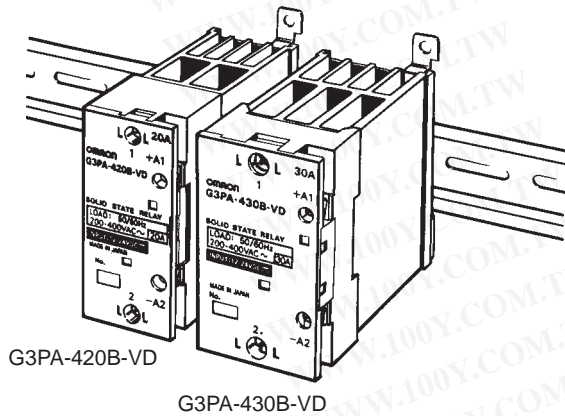
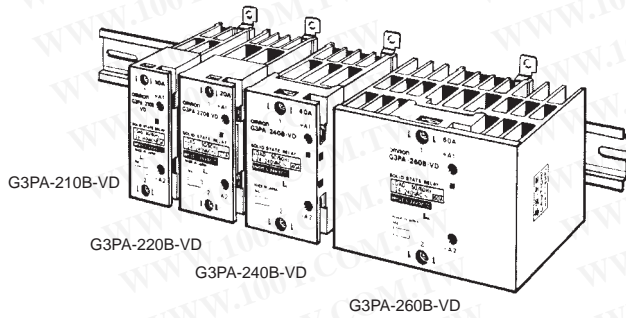

Operation indicator
 Temperature indicator

Note: Use the special tool for replacement of the cartridge (G3PA-210B-VD/220B-VD models only).

Linking terminal (except for G3PA-260B-VD)

Heat sink

DIN track mounting part

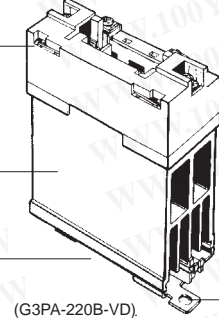

Mounting hole

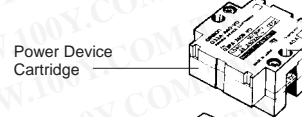
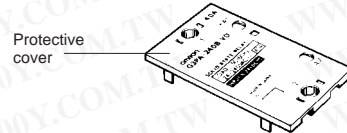

Operation indicator
 Temperature indicator

Linking terminal (except for G3PA-260B-VD)

Heat sink

DIN track mounting part

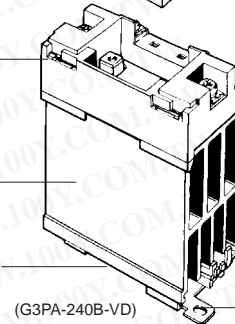

Mounting hole

Operation

■ Renewal Parts

G32A-A Power Device Cartridge

The G32A-A Power Device Cartridge (a Triac Unit) can be replaced with a new one. When the temperature indicator has changed from pink to red, the triac circuitry may have malfunctioned possibly by an excessive flow of current, in which case, dismount the damaged cartridge for replacement.

The damaged cartridge can be replaced with a new one without disconnecting the wires from the G3PA.

Improve the heat radiation efficiency of the G3PA before replacing the cartridge.

The G32A-A Power Device Cartridge can withstand an excessive current for a short period time, such as may be caused accidentally by the short circuitry of the load, in which case the temperature indicator will not turn red.

Appearance

G32A-A10(L)-VD

G32A-A20(L)-VD

G32A-A40(L)-VD

G32A-A60(L)-VD

G32A-A420-VD

G32A-A430-VD

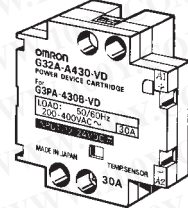
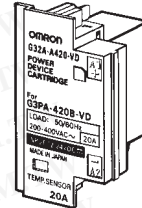
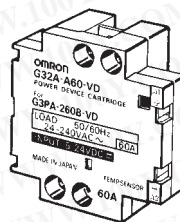
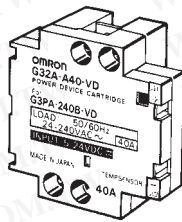
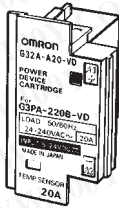
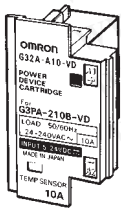

勝特力材料 886-3-5753170
 勝特力电子(上海) 86-21-54151736
 勝特力电子(深圳) 86-755-83298787
[Http://www.100y.com.tw](http://www.100y.com.tw)

Replacement

G32A-A10-VD/G32A-A20-VD/G32A-A420-VD

Use the special tool (provided) to extract the cartridge for replacement with a new one.

Extraction

Follow the procedures below to dismount the G32A-A Power Device Cartridge from the G3PA.

1. Switch off the power.
2. Remove the terminal cover.
3. Hook the indented part of the cartridge with the tool and pull up on the cartridge to remove it.

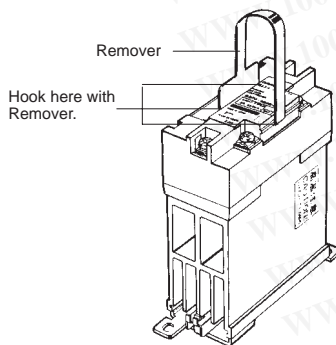

Mounting

Follow the procedures below to mount the G32A-A Power Device Cartridge on the G3PA.

1. Apply silicone grease (provided with the G32A-A) to the entire surface of the heat radiator.

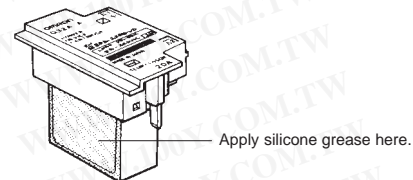

2. Make sure that there is no dust or pieces of wire on the heat radiator of the G32A-A or the G3PA.
3. Insert the cartridge into the opening of the G3PA so that the letters on the cartridge and those on the G3PA are in the same direction and side A and side B are even.

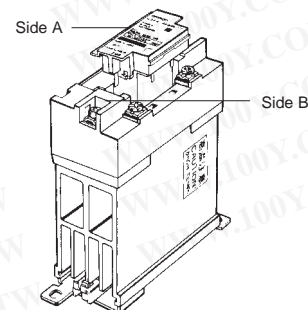

4. Attach the terminal cover.
5. Switch on the power and check the G3PA to be sure it works properly.

G32A-A40-VD/G32A-A60-VD/G32A-A430-VD

The G32A Power Device Cartridge is mounted and secured with screws to the G3PA Unit.

Extraction

Follow the procedures below to dismantle the G32A-A Power Device Cartridge from the G3PA.

1. Switch off the power.
2. Remove the terminal cover.
3. Loosen the two centered screws on the sides to dismantle the cartridge. The screws are connected to terminals 1 and 2.

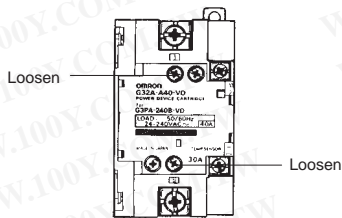

4. Loosen the screws on both the corners.

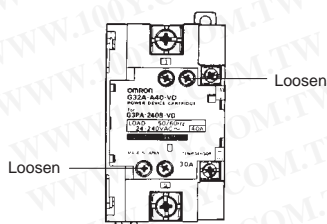

5. Hold the indented part of both the corners to dismantle the cartridge

勝特力材料 886-3-5753170
 勝特力电子(上海) 86-21-54151736
 勝特力电子(深圳) 86-755-83298787
[Http://www.100y.com.tw](http://www.100y.com.tw)

Mounting

1. Apply silicone grease to the entire surface of the heat radiator.

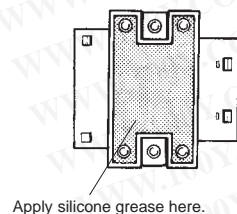

2. Make sure that there is no dust or pieces of wire on the radiator of the G32A-A or the G3PA.
3. Insert the cartridge into the opening of the G3PA so that side A and side B are even.

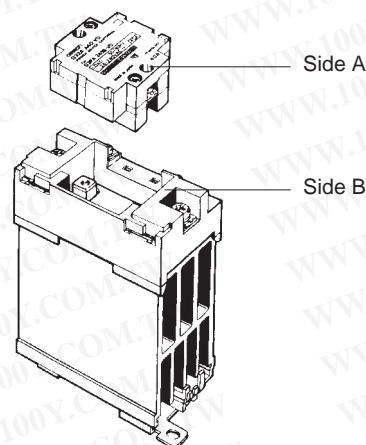

4. Tighten the screws on both the corners with a tightening torque of 6 to 8 kgf • cm (0.59 to 0.78 N • m).
5. Tighten the screws on both the sides with a tightening torque of 6 to 8 kgf • cm (0.59 to 0.78 N • m).
6. Attach the terminal cover.
7. Switch on the power and check the G3PA to be sure it works properly.

- Connecting with linking terminal for G3PA-210B-VD, -220B-VD, -240B-VD and G3PA-420B-VD, G3PA-430B-VD.

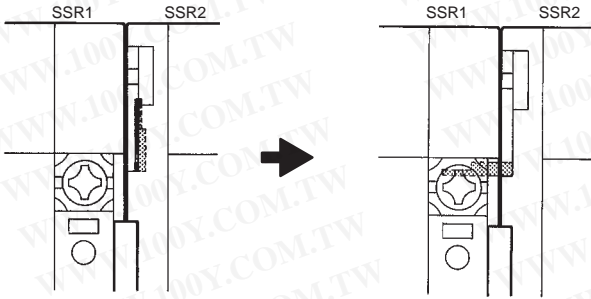

- When SSRs are densely mounted side-by-side, loosen the M3.5 Sems screw and flip the linking terminal down.
- Insert the linking terminal securely into the center of the screw and tighten the screw.

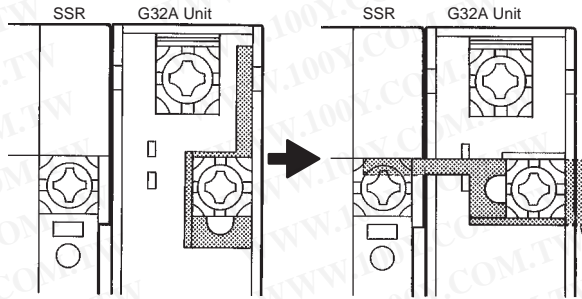

- When SSR are densely mounted side-by-side, loosen the M3.5 Sems screw on the G32A and flip the linking terminal down.
- Insert the linking terminal securely into the center of the screw and tighten the screw. Ensure that the linking terminal does not protrude.

* The cover will not fit if the terminal protrudes.

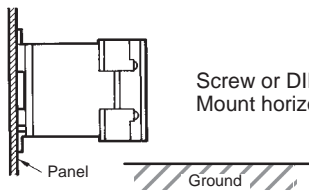
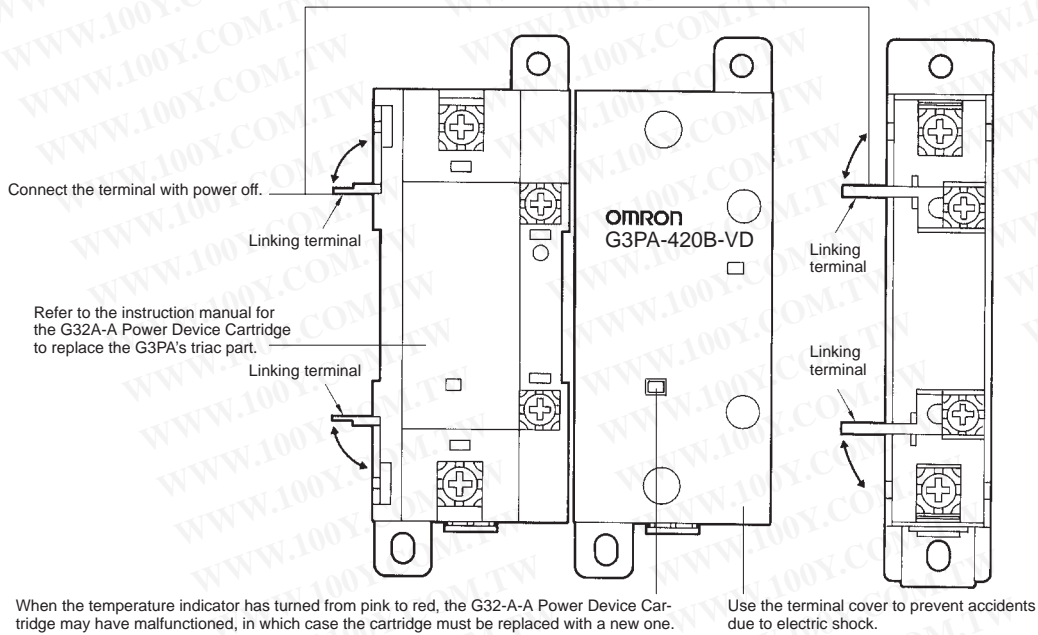

Screw or DIN track mounting is possible. Mount horizontally to ground.

勝特力材料 886-3-5753170
 勝特力电子(上海) 86-21-54151736
 勝特力电子(深圳) 86-755-83298787
[Http://www.100y.com.tw](http://www.100y.com.tw)

Dense Mounting

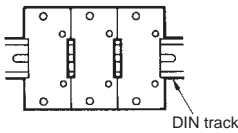

Dense mounting side-by-side up to three G3PA SSRs is possible. Load current should be reduced by 10% for G3PA-210B-VD, -220B-VD, -240B-VD, and by 20% for other models. To mount more than three G3PA SSRs densely side-by-side, keep a distance of 10 mm between each SSR.

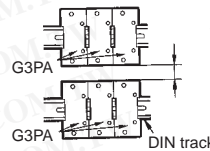

Keep a distance of 80 mm between the upper SSR and the lower SSR.

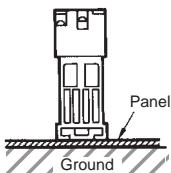

For vertical mounting, the load current must be 30% lower than the rated one (refer to Engineering Data).

At a rated ambient temperature for each.

Note: Keep a distance of 3 cm or more between the G3PA (especially the SSR on the upper side) and the duct.

Dimensions

Note: All units are in millimeters unless otherwise indicated.

勝特力材料 886-3-5753170
 勝特力电子(上海) 86-21-54151736
 勝特力电子(深圳) 86-755-83298787
[Http://www.100y.com.tw](http://www.100y.com.tw)

G3PA-210B-VD

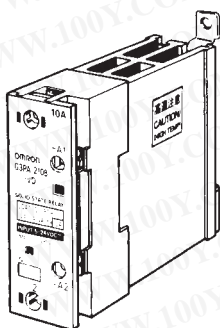

Without Terminal Cover

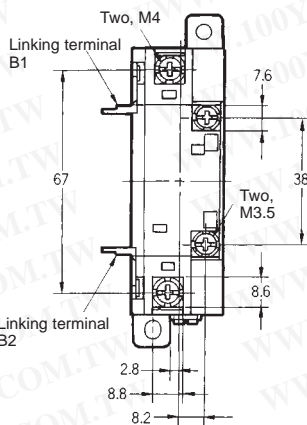

With Terminal Cover

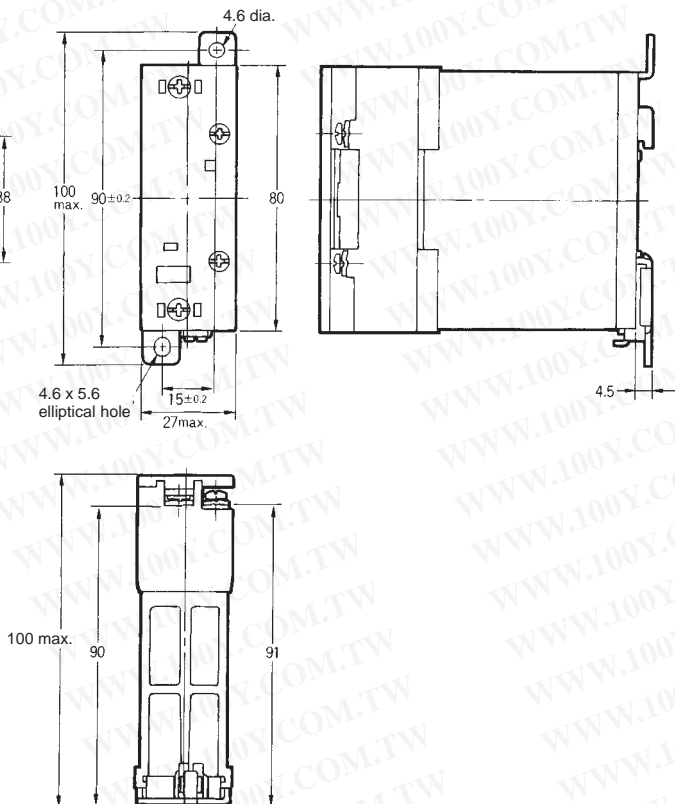

Mounting Holes

Two, 4.5 dia. or M4 holes

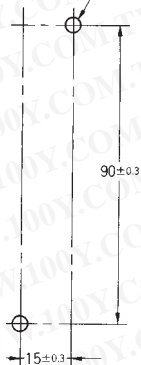

Terminal Arrangement/
Internal Connections

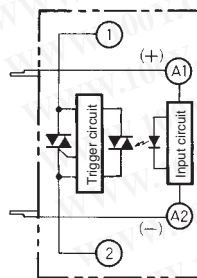

G3PA-220B-VD

勝特力材料 886-3-5753170
 勝特力电子(上海) 86-21-54151736
 勝特力电子(深圳) 86-755-83298787
[Http://www.100y.com.tw](http://www.100y.com.tw)

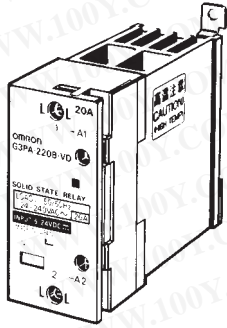

Without Terminal Cover

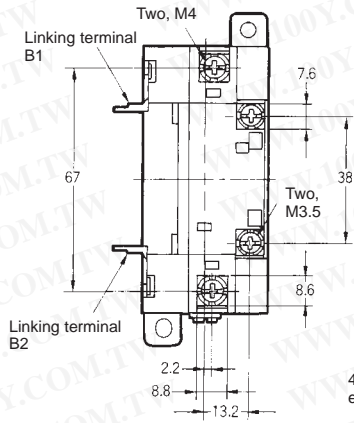

With Terminal Cover

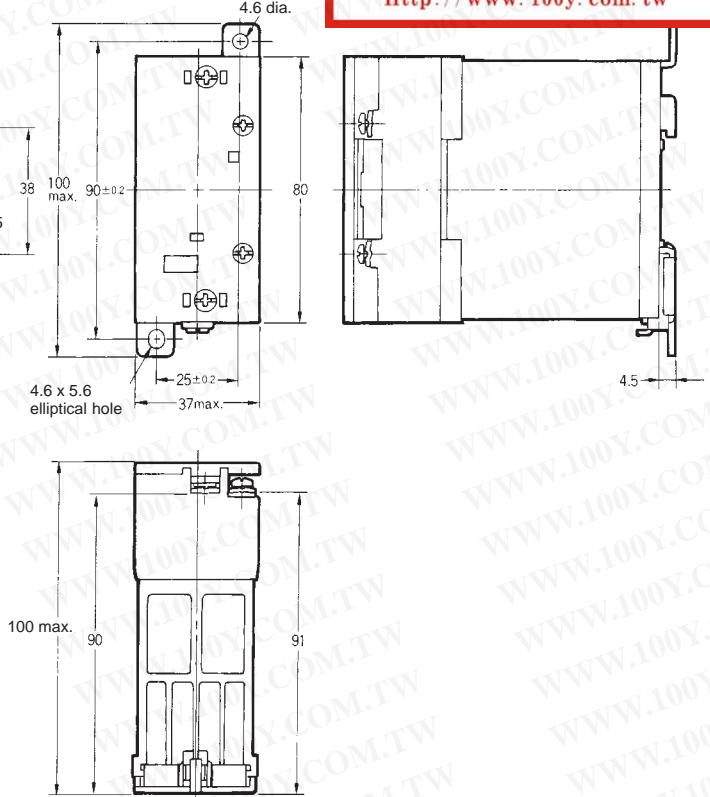

Mounting Holes

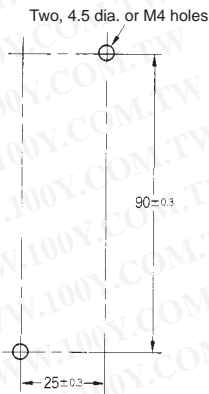

Terminal Arrangement/
Internal Connections

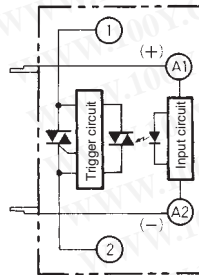

G3PA-240B-VD

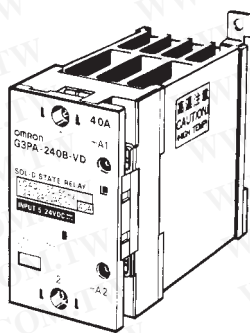

勝特力材料 886-3-5753170
 胜特力电子(上海) 86-21-54151736
 胜特力电子(深圳) 86-755-83298787
[Http://www.100y.com.tw](http://www.100y.com.tw)

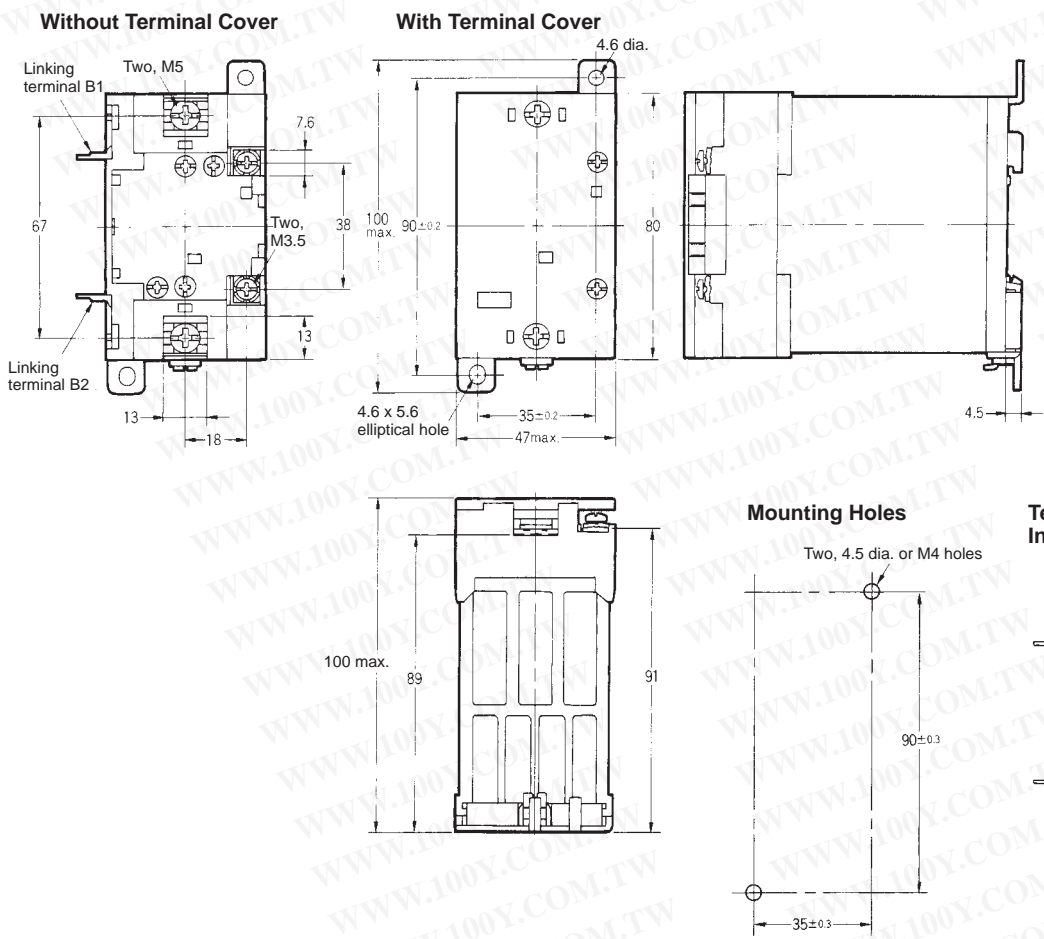

G3PA-260B-VD

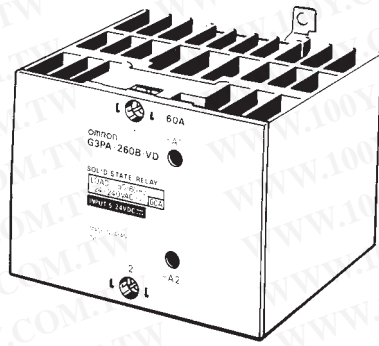

勝特力材料 886-3-5753170
 勝特力电子(上海) 86-21-54151736
 勝特力电子(深圳) 86-755-83298787
[Http://www.100y.com.tw](http://www.100y.com.tw)

Without Terminal Cover

With Terminal Cover

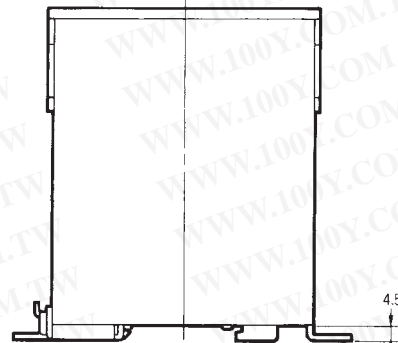
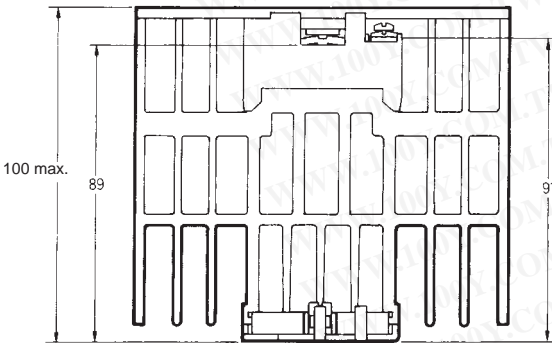
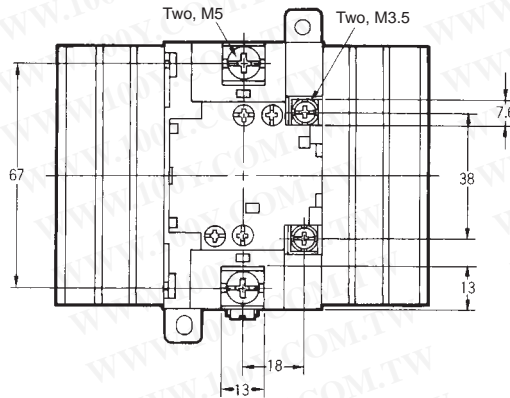
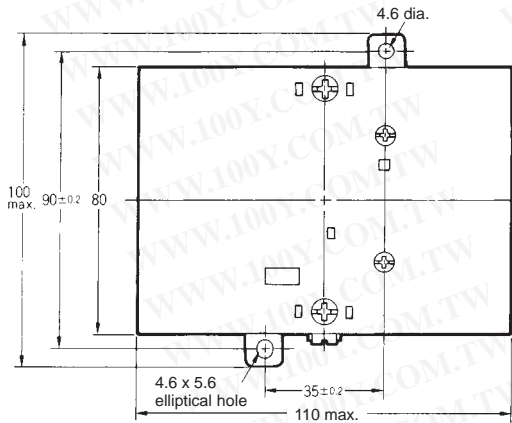

Mounting Holes

Terminal Arrangement/
Internal Connections

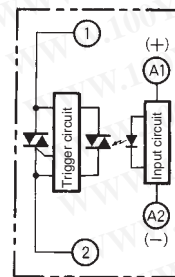
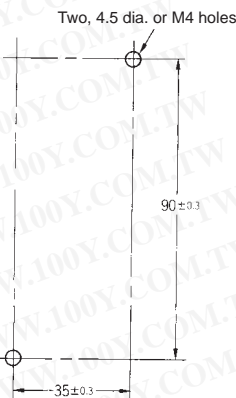

G3PA-420B-VD

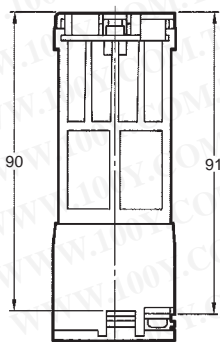
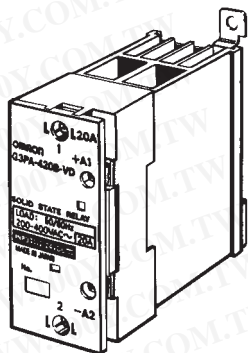

Terminal Arrangement/
Internal Connections

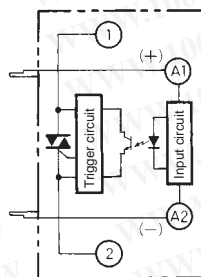

Mounting Holes

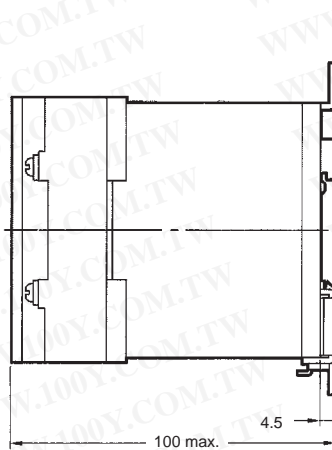
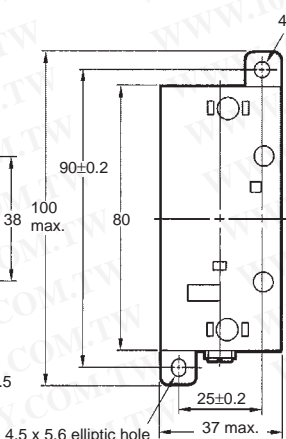
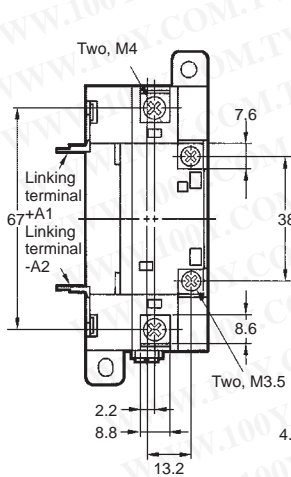

Two, 4.5 dia. or M4

G3PA-430B-VD

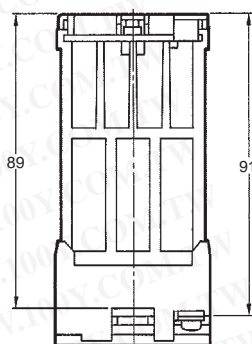
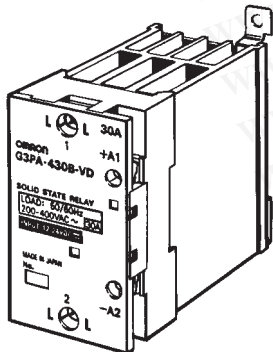

Terminal Arrangement/
Internal Connections

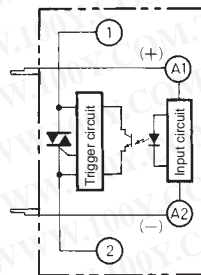

Mounting Holes

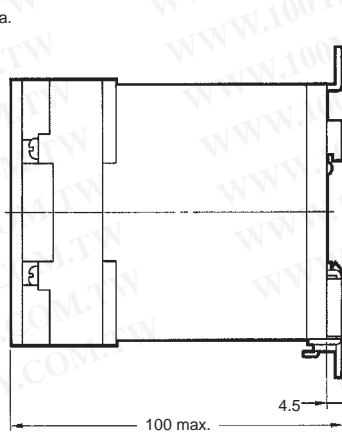
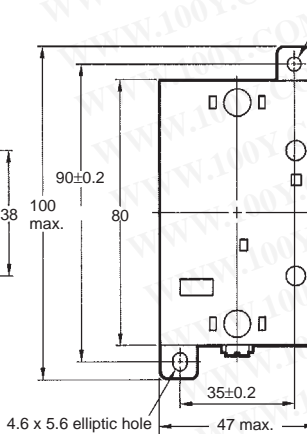
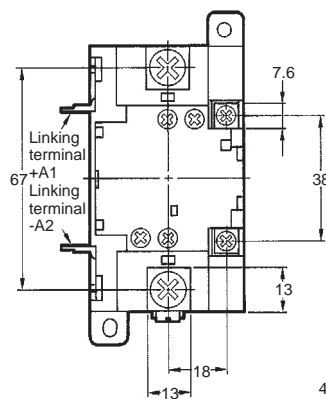

Two, 4.5 dia. or M4

勝特力材料 886-3-5753170
 勝特力电子(上海) 86-21-54151736
 勝特力电子(深圳) 86-755-83298787
[Http://www.100y.com.tw](http://www.100y.com.tw)

勝特力材料 886-3-5753170
勝特力电子(上海) 86-21-54151736
勝特力电子(深圳) 86-755-83298787
[Http://www.100y.com.tw](http://www.100y.com.tw)

ALL DIMENSIONS SHOWN ARE IN MILLIMETERS.

To convert millimeters into inches, multiply by 0.03937. To convert grams into ounces, multiply by 0.03527.

Cat. No. K94-E1-3

In the interest of product improvement, specifications are subject to change without notice.

OMRON Corporation

Control Components Division H.Q.

28th Fl., Crystal Tower Bldg.

1-2-27, Shiromi, Chuo-ku,

Osaka 540 Japan

Phone: 06-949-6115/Fax: 06-949-6134

Printed in Japan
0397-1M (0796) a