

June 1993

54AC/74AC14 Hex Inverter with Schmitt Trigger Input

General Description

The 'AC14 contains six inverter gates each with a Schmitt trigger input. The 'AC14 contains six logic inverters which accept standard CMOS input signals and provide standard CMOS output levels. They are capable of transforming slowly changing input signals into sharply defined, jitter-free output signals. In addition, they have a greater noise margin than conventional inverters.

The 'AC14 has hysteresis between the positive-going and negative-going input thresholds (typically 1.0V) which is determined internally by transistor ratios and is essentially insensitive to temperature and supply voltage variations.

Features

- I_{CC} reduced by 50%
- Outputs source/sink 24 mA
- Standard Military Drawing (SMD)
— 'AC14: 5962-87624

Logic Symbol

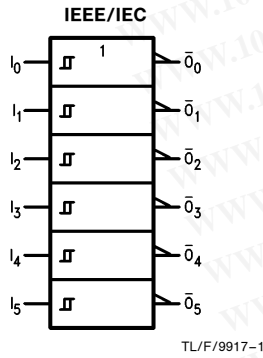

Function Table

Input	Output
A	\bar{O}
L	H
H	L

Connection Diagrams

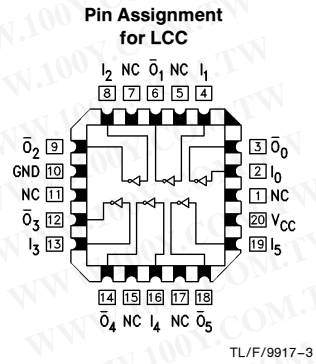
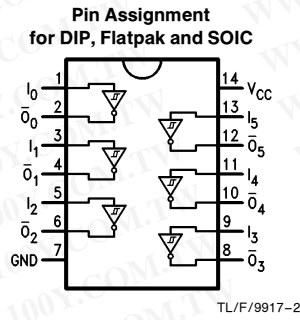

Pin Names	Description
I_n	Inputs
O_n	Outputs

Absolute Maximum Ratings (Note 1)

If Military/Aerospace specified devices are required, please contact the National Semiconductor Sales Office/Distributors for availability and specifications.

Supply Voltage (V_{CC})	-0.5V to +7.0V
DC Input Diode Current (I_{IK})	
$V_I = -0.5V$	-20 mA
$V_I = V_{CC} + 0.5V$	+20 mA
DC Input Voltage (V_I)	-0.5V to $V_{CC} + 0.5V$
DC Output Diode Current (I_{OK})	
$V_O = -0.5V$	-20 mA
$V_O = V_{CC} + 0.5V$	+20 mA
DC Output Voltage (V_O)	-0.5V to $V_{CC} + 0.5V$
DC Output Source or Sink Current (I_O)	±50 mA
DC V_{CC} or Ground Current per Output Pin (I_{CC} or I_{GND})	±50 mA
Storage Temperature (T_{STG})	-65°C to +150°C
Junction Temperature (T_J)	
CDIP	175°C
PDIP	140°C

Note 1: Absolute maximum ratings are those values beyond which damage to the device may occur. The databook specifications should be met, without exception, to ensure that the system design is reliable over its power supply, temperature, and output/input loading variables. National does not recommend operation of FACT™ circuits outside databook specifications.

Recommended Operating Conditions

Supply Voltage (V_{CC}) 'AC	2.0V to 6.0V
Input Voltage (V_I)	0V to V_{CC}
Output Voltage (V_O)	0V to V_{CC}
Operating Temperature (T_A)	
74AC	-40°C to +85°C
54AC	-55°C to +125°C

勝特力材料 886-3-5753170
 勝特力电子(上海) 86-21-54151736
 勝特力电子(深圳) 86-755-83298787
[Http://www.100y.com.tw](http://www.100y.com.tw)

DC Characteristics for 'AC Family Devices

Symbol	Parameter	V_{CC} (V)	74AC		54AC	74AC		Units	Conditions
			$T_A = +25^\circ\text{C}$		$T_A = -55^\circ\text{C to } +125^\circ\text{C}$	$T_A = -40^\circ\text{C to } +85^\circ\text{C}$			
			Typ	Guaranteed Limits					
V_{OH}	Minimum High Level Output Voltage	3.0	2.99	2.9	2.9	2.9	2.9	V	$I_{OUT} = -50 \mu\text{A}$
		4.5	4.49	4.4	4.4	4.4	4.4		
		5.5	5.49	5.4	5.4	5.4	5.4		
			3.0		2.56	2.4	2.46	V	* $V_{IN} = V_{IL}$ or V_{IH} -12 mA $I_{OH} = -24 \text{ mA}$ -24 mA
			4.5		3.86	3.7	3.76		
			5.5		4.86	4.7	4.76		
V_{OL}	Maximum Low Level Output Voltage	3.0	0.002	0.1	0.1	0.1	0.1	V	$I_{OUT} = 50 \mu\text{A}$
		4.5	0.001	0.1	0.1	0.1	0.1		
		5.5	0.001	0.1	0.1	0.1	0.1		
			3.0		0.36	0.5	0.44	V	* $V_{IN} = V_{IL}$ or V_{IH} 12 mA $I_{OL} = 24 \text{ mA}$ 24 mA
			4.5		0.36	0.5	0.44		
			5.5		0.36	0.5	0.44		
I_{IN}	Maximum Input Leakage Current	5.5		±0.1	±1.0	±1.0	μA	$V_I = V_{CC}, \text{GND}$	
V_{t+}	Maximum Positive Threshold	3.0		2.2	2.2	2.2	V	$T_A = \text{Worst Case}$	
		4.5		3.2	3.2	3.2			
		5.5		3.9	3.9	3.9			
V_{t-}	Minimum Negative Threshold	3.0		0.5	0.5	0.5	V	$T_A = \text{Worst Case}$	
		4.5		0.9	0.9	0.9			
		5.5		1.1	1.1	1.1			

*All outputs loaded; thresholds on input associated with output under test.

DC Characteristics for 'AC Family Devices (Continued)

Symbol	Parameter	V _{CC} (V)	74AC		54AC		74AC		Units	Conditions
			T _A = +25°C		T _A = -55°C to +125°C		T _A = -40°C to +85°C			
			Typ	Guaranteed Limits						
V _{h(max)}	Maximum Hysteresis	3.0		1.2	1.2	1.2			V	T _A = Worst Case
		4.5		1.4	1.4	1.4				
		5.5		1.6	1.6	1.6				
V _{h(min)}	Minimum Hysteresis	3.0		0.3	0.3	0.3			V	T _A = Worst Case
		4.5		0.4	0.4	0.4				
		5.5		0.5	0.5	0.5				
I _{OLD}	†Minimum Dynamic Output Current	5.5			50	75			mA	V _{OLD} = 1.65V Max
I _{OHD}		5.5			-50	-75			mA	V _{OHD} = 3.85V Min
I _{CC}	Maximum Quiescent Supply Current	5.5		2.0	40.0	20.0			μA	V _{IN} = V _{CC} or GND

†Maximum test duration 2.0 ms, one output loaded at a time.

Note: I_{IN} and I_{CC} @ 3.0V are guaranteed to be less than or equal to the respective limit @ 5.5V V_{CC}.

I_{CC} for 54AC @ 25°C is identical to 74AC @ 25°C.

AC Electrical Characteristics

Symbol	Parameter	V _{CC} * (V)	74AC			54AC		74AC		Units
			T _A = +25°C C _L = 50 pF			T _A = -55°C to +125°C C _L = 50 pF		T _A = -40°C to +85°C C _L = 50 pF		
			Min	Typ	Max	Min	Max	Min	Max	
t _{PLH}	Propagation Delay	3.3	1.5	9.5	13.5	1.0	16.0	1.5	15.0	ns
		5.0	1.5	7.0	10.0	1.0	12.0	1.5	11.0	
t _{PHL}	Propagation Delay	3.3	1.5	7.5	11.5	1.0	14.0	1.5	13.0	ns
		5.0	1.5	6.0	8.5	1.5	10.0	1.5	9.5	

*Voltage Range 3.3 is 3.3V ±0.3V
Voltage Range 5.0 is 5.0V ±0.5V

Capacitance

Symbol	Parameter	Typ	Units	Conditions
C _{IN}	Input Capacitance	4.5	pF	V _{CC} = OPEN
C _{PD}	Power Dissipation Capacitance	25.0	pF	V _{CC} = 5.0V

勝特力材料 886-3-5753170
勝特力电子(上海) 86-21-54151736
勝特力电子(深圳) 86-755-83298787
[Http://www.100y.com.tw](http://www.100y.com.tw)

Ordering Information

The device number is used to form part of a simplified purchasing code where the package type and temperature range are defined as follows:

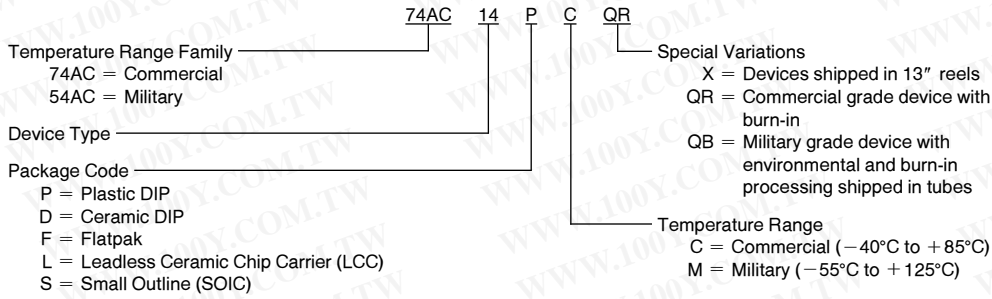

Physical Dimensions inches (millimeters)

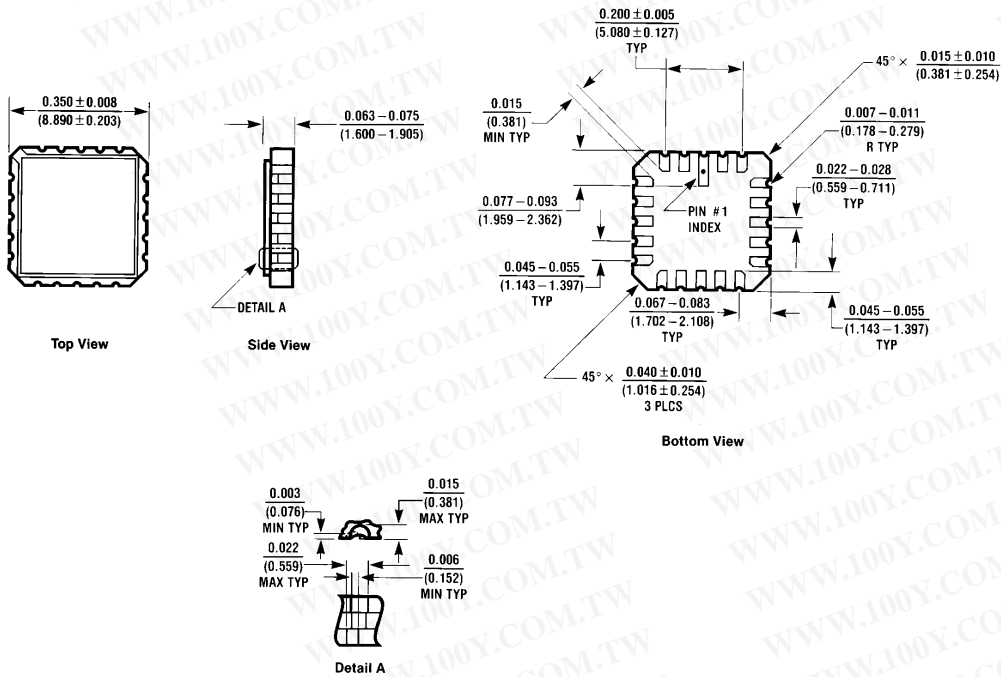

20 Terminal Ceramic Leadless Chip Carrier (L)
 NS Package Number E20A

E20A (REV D)

勝特力材料 886-3-5753170
 勝特力电子(上海) 86-21-54151736
 勝特力电子(深圳) 86-755-83298787
[Http://www.100y.com.tw](http://www.100y.com.tw)

Physical Dimensions inches (millimeters) (Continued)

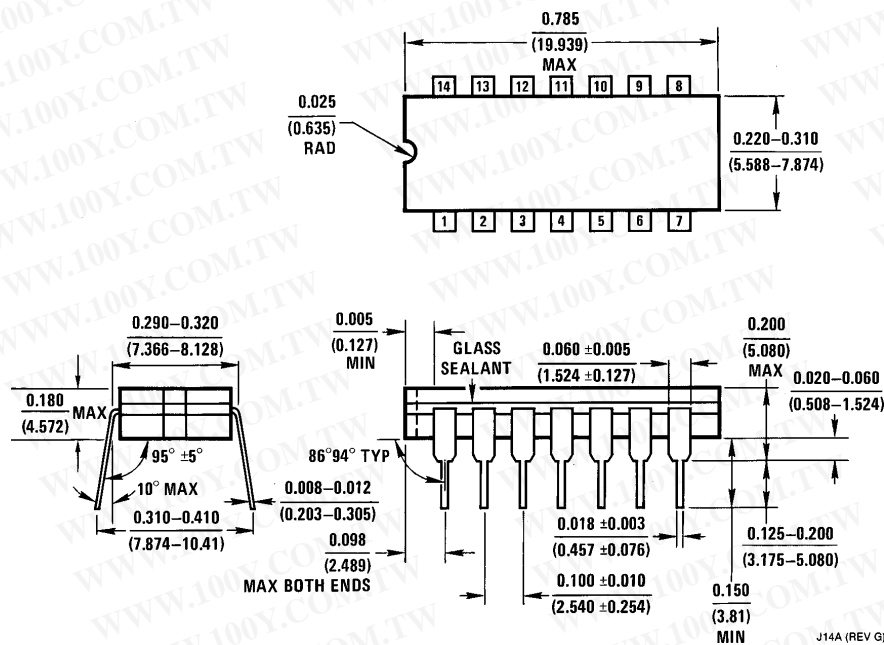

14-Lead Ceramic Dual-In-Line Package (D)
NS Package Number J14A

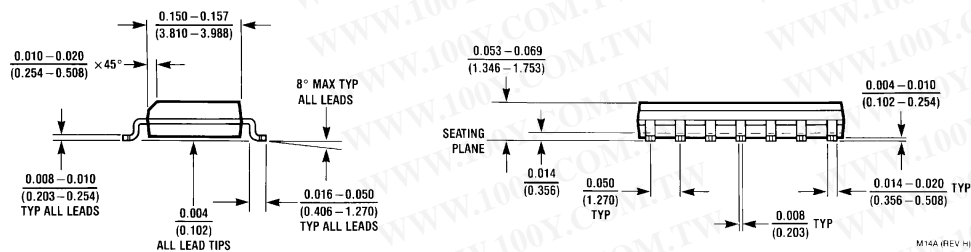
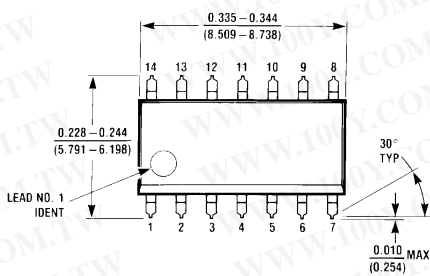

14-Lead Small Outline Integrated Circuit (S)
NS Package Number M14A

勝特力材料 886-3-5753170
 勝特力电子(上海) 86-21-54151736
 勝特力电子(深圳) 86-755-83298787
[Http://www.100y.com.tw](http://www.100y.com.tw)

