

16A, COMPACT AND HIGH INSULATION POWER LATCHING RELAY

DJ RELAYS (ADJ)



Without test button With test button

FEATURES

1. Variety of contact arrangements

Wide lineup of 1 Form C, 1 Form A, 1 Form B, 2 Form C, 2 Form A, 2 Form B, 1 Form A 1 Form B.

2. Latching operation

Latching via a polarized magnetic circuit structure allows remote operation and lower energy consumption

3. Compact with high capacity

16A (1-pole type) contact rating in a compact 29×13×16.5 mm (L×W×H) size.

4. Low power consumption

1 coil latching: 150mW
2 coil latching, single side stable: 250mW

5. High insulation

Both clearance and creepage distance between coil and contact are at 8 mm min.

5. With operation verification function

A test button (manual lever) type to facilitate circuit checks is also available (1 Form C, 1 Form A, 1 Form B types only).

TYPICAL APPLICATIONS

- FA equipment (brake circuits of industrial machine and robots, etc.)
- Electric power devices (remote surveillance devices, etc.)
- Household appliance networks (Motor control and lighting control, etc.)
- Time switches

RoHS Directive compatibility information
<http://www.nais-e.com/>

勝特力材料 886-3-5753170
勝特力电子(上海) 86-21-54151736
勝特力电子(深圳) 86-755-83298787
[Http://www.100y.com.tw](http://www.100y.com.tw)

SPECIFICATIONS

Contact

Arrangement	1 Form C, 1 Form A, 1 Form B, 1 Form A 1 Form B, 2 Form C, 2 Form A, 2 Form B	
Initial contact resistance, max. (By voltage drop 6 V DC 1 A)	100 mΩ	
Contact material	AgSnO ₂ type (1 Form C, 1 Form A, 1 Form B) Au-flashed AgSnO ₂ type (1 Form A 1 Form B, 2 Form C, 2 Form A, 2 Form B)	
Rating (resistive load)	Nominal switching capacity	16 A 250V AC (1 Form C, 1 Form A, 1 Form B) 10 A 250V AC (2 Form C, 2 Form A, 2 Form B, 1 Form A 1 Form B)
	Max. switching power	4,000 V A
	Max. switching voltage	250V AC
	Max. switching current	16 A
	Min. switching capacity (Reference value) ^{#1}	100 mA, 5 V DC
Expected life (min. operations)	Mechanical (at 180 cpm)	5×10 ⁶
	Electrical (Resistive load) ^{*1} (at 20 cpm)	1 Form C, 1 Form A, 1 Form B: 10 ⁵ (at 16A 250V AC) 2 Form C, 2 Form A, 2 Form B, 1 Form A 1 Form B: : 10 ⁵ (at 10A 250V AC)

Coil

Nominal operating power	1 coil latching	150mW
	Single side stable, 2 coil latching	250mW

#1 This value can change due to the switching frequency, environmental conditions, and desired reliability level, therefore it is recommended to check this with the actual load.

Characteristics

Initial insulation resistance ^{*2}		Min. 1,000 MΩ (at 500 V DC)
Initial breakdown voltage ^{*3}	Between open contacts	1,000 Vrms for 1 min.
	Between contacts and coil	4,000 Vrms for 1 min.
Surge voltage between contact and coil ^{*4}		Min. 10,000 V (initial)
Operate time [Set time] ^{*5} (at nominal voltage)		Approx. 10ms
Release time [Reset time] ^{*5} (at nominal voltage)		Approx. 10ms
Temperature rise (at 70°C) ^{*6}		Max. 55°C
Shock resistance	Functional ^{*7}	Min. 200 m/s ² {20 G}
	Destructive ^{*8}	Min. 1,000 m/s ² {100 G}
Vibration resistance	Functional ^{*9}	10 to 55Hz at double amplitude of 2.0mm
	Destructive	10 to 55Hz at double amplitude of 3.0mm
Conditions for operation, transport and storage ^{*10} (Not freezing and condensing at low temperature)	Ambient temperature	-40°C to +70°C -40°F to +158°F
	Humidity	5 to 85% R.H.
Unit weight		Approx. 14 g .49 oz

Remarks

- *1 With breathing holes open
- *2 Measurement at same location as "Initial breakdown voltage" section.
- *3 Detection current: 10mA
- *4 Wave is standard shock voltage of ±1.2 × 50μs according to JEC-212-1981
- *5 Excluding contact bounce time.
- *6 By resistive method, max. switching current
- *7 Half-wave pulse of sine wave: 11 ms; detection time: 10 μs
- *8 Half-wave pulse of sine wave: 6 ms
- *9 Detection time: 10 μs
- *10 Refer to 5. Conditions for operation, transport and storage mentioned in NOTES

勝特力材料 886-3-5753170
 勝特力电子(上海) 86-21-54151736
 勝特力电子(深圳) 86-755-83298787
[Http://www.100y.com.tw](http://www.100y.com.tw)

DJ (ADJ)

ORDERING INFORMATION

Ex. ADJ

Contact arrangement	Operating function and protective construction	Auxiliary function	Coil voltage (DC)
1: 1 Form C 2: 1 Form A 3: 1 Form B 4: 1 Form A 1 Form B 5: 2 Form C 6: 2 Form A 7: 2 Form B	1: 1 coil latching, Flux-resistant type 2: 1 coil latching, Sealed type 3: 2 coil latching, Flux-resistant type 4: 2 coil latching, Sealed type 5: Single side stable, Flux-resistant type 6: Single side stable, Sealed type	0: Without test button 1: With test button	05: 5 V 12: 12 V 06: 6 V 24: 24 V 48: 48 V

Note: Standard packing: Carton: 100 pcs, Case: 500 pcs

TYPES

1. Without test button

1) Flux-resistant type

Contact arrangement	Coil voltage, V DC	Single side stable type	1 coil latching type	2 coil latching type
		Part No.	Part No.	Part No.
1 Form C	5	ADJ15005	ADJ11005	ADJ13005
	6	ADJ15006	ADJ11006	ADJ13006
	12	ADJ15012	ADJ11012	ADJ13012
	24	ADJ15024	ADJ11024	ADJ13024
	48	ADJ15048	ADJ11048	ADJ13048
1 Form A	5	ADJ25005	ADJ21005	ADJ23005
	6	ADJ25006	ADJ21006	ADJ23006
	12	ADJ25012	ADJ21012	ADJ23012
	24	ADJ25024	ADJ21024	ADJ23024
	48	ADJ25048	ADJ21048	ADJ23048
1 Form B	5	ADJ35005	Please use 1 Form A.	Please use 1 Form A.
	6	ADJ35006		
	12	ADJ35012		
	24	ADJ35024		
	48	ADJ35048		
1 Form A 1 Form B	5	ADJ45005	ADJ41005	ADJ43005
	6	ADJ45006	ADJ41006	ADJ43006
	12	ADJ45012	ADJ41012	ADJ43012
	24	ADJ45024	ADJ41024	ADJ43024
	48	ADJ45048	ADJ41048	ADJ43048
2 Form C	5	ADJ55005	ADJ51005	ADJ53005
	6	ADJ55006	ADJ51006	ADJ53006
	12	ADJ55012	ADJ51012	ADJ53012
	24	ADJ55024	ADJ51024	ADJ53024
	48	ADJ55048	ADJ51048	ADJ53048
2 Form A	5	ADJ65005	ADJ61005	ADJ63005
	6	ADJ65006	ADJ61006	ADJ63006
	12	ADJ65012	ADJ61012	ADJ63012
	24	ADJ65024	ADJ61024	ADJ63024
	48	ADJ65048	ADJ61048	ADJ63048
2 Form B	5	ADJ75005	Please use 2 Form A.	Please use 2 Form A.
	6	ADJ75006		
	12	ADJ75012		
	24	ADJ75024		
	48	ADJ75048		

DJ (ADJ)

勝特力材料 886-3-5753170
勝特力电子(上海) 86-21-54151736
勝特力电子(深圳) 86-755-83298787
[Http://www.100y.com.tw](http://www.100y.com.tw)

2) Sealed type

Contact arrangement	Coil voltage, V DC	Single side stable type	1 coil latching type	2 coil latching type
		Part No.	Part No.	Part No.
1 Form C	5	ADJ16005	ADJ12005	ADJ14005
	6	ADJ16006	ADJ12006	ADJ14006
	12	ADJ16012	ADJ12012	ADJ14012
	24	ADJ16024	ADJ12024	ADJ14024
	48	ADJ16048	ADJ12048	ADJ14048
1 Form A	5	ADJ26005	ADJ22005	ADJ24005
	6	ADJ26006	ADJ22006	ADJ24006
	12	ADJ26012	ADJ22012	ADJ24012
	24	ADJ26024	ADJ22024	ADJ24024
1 Form B	5	ADJ36005	Please use 1 Form A.	Please use 1 Form A.
	6	ADJ36006		
	12	ADJ36012		
	24	ADJ36024		
1 Form A 1 Form B	5	ADJ46005	ADJ42005	ADJ44005
	6	ADJ46006	ADJ42006	ADJ44006
	12	ADJ46012	ADJ42012	ADJ44012
	24	ADJ46024	ADJ42024	ADJ44024
2 Form C	5	ADJ56005	ADJ52005	ADJ54005
	6	ADJ56006	ADJ52006	ADJ54006
	12	ADJ56012	ADJ52012	ADJ54012
	24	ADJ56024	ADJ52024	ADJ54024
2 Form A	5	ADJ66005	ADJ62005	ADJ64005
	6	ADJ66006	ADJ62006	ADJ64006
	12	ADJ66012	ADJ62012	ADJ64012
	24	ADJ66024	ADJ62024	ADJ64024
2 Form B	5	ADJ76005	Please use 2 Form A.	Please use 2 Form A.
	6	ADJ76006		
	12	ADJ76012		
	24	ADJ76024		
	48	ADJ76048		

2. With test button Flux-resistant type

Contact arrangement	Coil voltage, V DC	Single side stable type	1 coil latching type	2 coil latching type
		Part No.	Part No.	Part No.
1 Form C	5	ADJ15105	ADJ11105	ADJ13105
	6	ADJ15106	ADJ11106	ADJ13106
	12	ADJ15112	ADJ11112	ADJ13112
	24	ADJ15124	ADJ11124	ADJ13124
	48	ADJ15148	ADJ11148	ADJ13148
1 Form A	5	ADJ25105	ADJ21105	ADJ23105
	6	ADJ25106	ADJ21106	ADJ23106
	12	ADJ25112	ADJ21112	ADJ23112
	24	ADJ25124	ADJ21124	ADJ23124
	48	ADJ25148	ADJ21148	ADJ23148
1 Form B	5	ADJ35105	Please use 1 Form A.	Please use 1 Form A.
	6	ADJ35106		
	12	ADJ35112		
	24	ADJ35124		
	48	ADJ35148		

COIL DATA (at 20°C 68°F)

• Single side stable type

Nominal voltage, V DC	Set voltage, max. V DC (initial)	Reset voltage, max. V DC (initial)	Coil resistance, Ω (±10%)	Nominal operating power, mW	Max. allowable voltage, V DC
5	3.75	0.5	100	250	6.5
6	4.5	0.6	144		7.8
12	9	1.2	576		15.6
24	18	2.4	2,304		31.2
48	36	4.8	9,216		62.4

• 1 coil latching type

Nominal voltage, V DC	Set voltage, max. V DC (initial)	Reset voltage, max. V DC (initial)	Coil resistance, Ω (±10%)	Nominal operating power, mW	Max. allowable voltage, V DC
5	3.5	3.5	167	150	6.5
6	4.2	4.2	240		7.8
12	8.4	8.4	960		15.6
24	16.8	16.8	3,840		31.2
48	33.6	33.6	15,360		62.4

• 2 coil latching type

Nominal voltage, V DC	Set voltage, max. V DC (initial)	Reset voltage, max. V DC (initial)	Coil resistance, Ω (±10%)	Nominal operating power, mW	Max. allowable voltage, V DC
5	3.5	3.5	100	250	6.5
6	4.2	4.2	144		7.8
12	8.4	8.4	576		15.6
24	16.8	16.8	2,304		31.2
48	33.6	33.6	9,216		62.4

DIMENSIONS

mm inch

1. 1 Form C, without test button

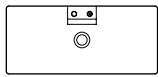

PC board pattern (Bottom view)

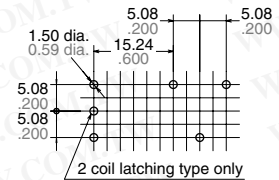

Tolerance: ±0.1 ±.004

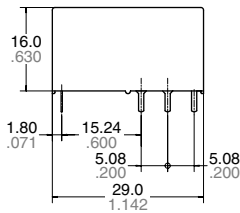

Single side stable type

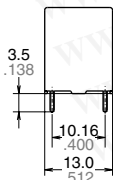

1 coil latching type

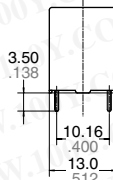

2 coil latching type

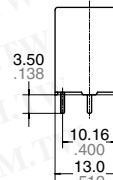

General tolerance: ±0.3 ±.012

Schematic (Bottom view)

Single side stable type

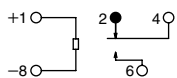

1 coil latching type

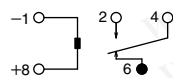

2 coil latching type

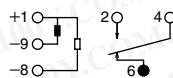

DJ (ADJ)

勝特力材料 886-3-5753170
勝特力电子(上海) 86-21-54151736
勝特力电子(深圳) 86-755-83298787
[Http://www.100y.com.tw](http://www.100y.com.tw)

2.1 Form C, with test button

mm inch

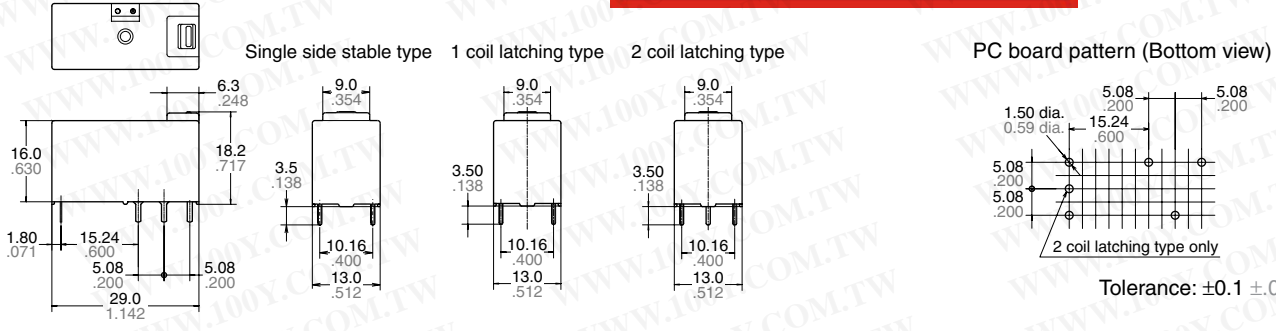

Schematic (Bottom view)

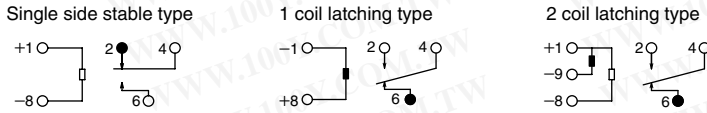

3.1 Form A, without test button

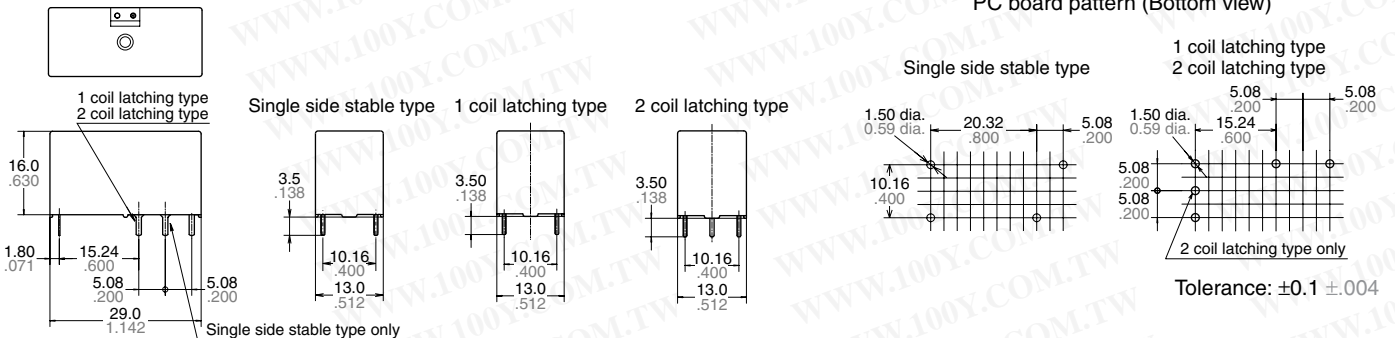

Schematic (Bottom view)

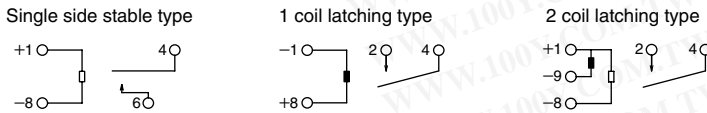

4.1 Form A, with test button

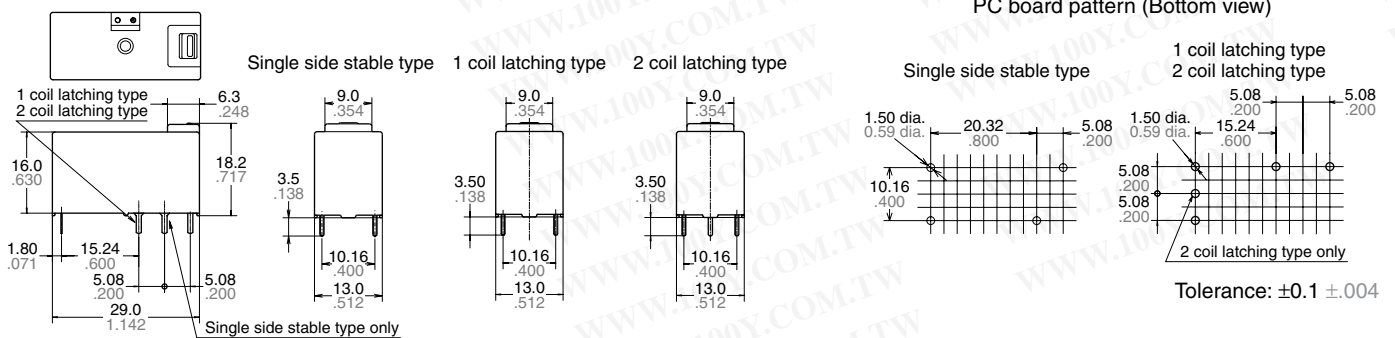

Schematic (Bottom view)

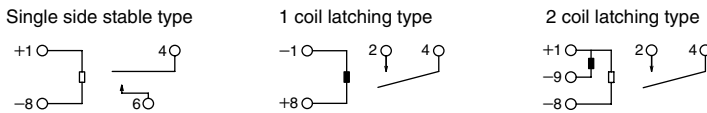

5. 1 Form B, without test button

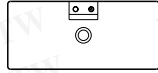

PC board pattern (Bottom view)

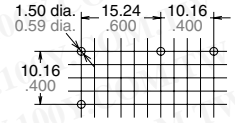

Tolerance: $\pm 0.1 \pm .004$

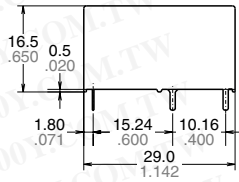

Single side stable type

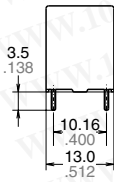

General tolerance: $\pm 0.3 \pm .012$

Schematic (Bottom view)

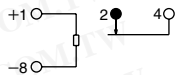

6. 1 Form B, with test button

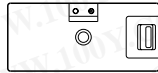

PC board pattern (Bottom view)

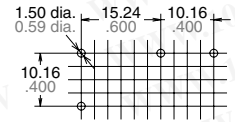

Tolerance: $\pm 0.1 \pm .004$

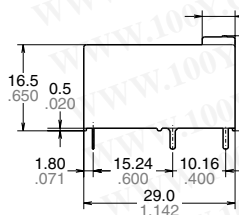

Single side stable type

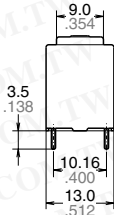

General tolerance: $\pm 0.3 \pm .012$

Schematic (Bottom view)

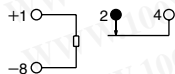

7. 1 Form A 1 Form B, without test button

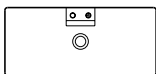

PC board pattern (Bottom view)

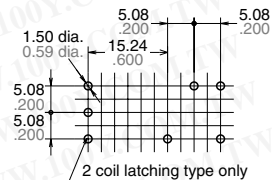

Tolerance: $\pm 0.1 \pm .004$

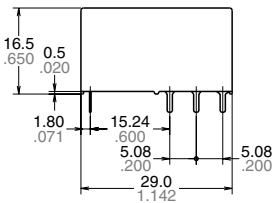

Single side stable type

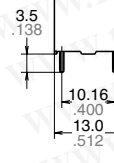
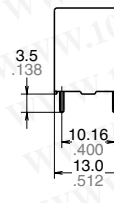

1 coil latching type

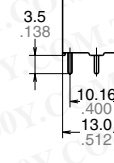
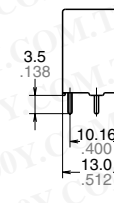

General tolerance: $\pm 0.3 \pm .012$

Schematic (Bottom view)

Single side stable type

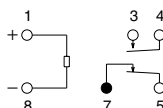

1 coil latching type

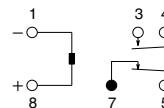

2 coil latching type

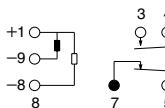

DJ (ADJ)

8. 2 Form C, without test button

mm inch

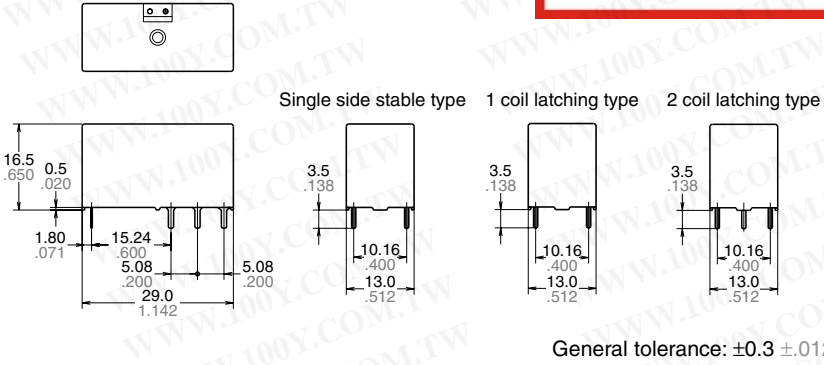

PC board pattern (Bottom view)

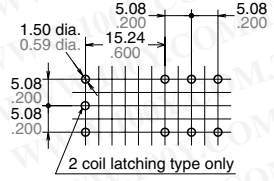

Tolerance: $\pm 0.1 \pm 0.04$

General tolerance: $\pm 0.3 \pm 0.12$

Schematic (Bottom view)

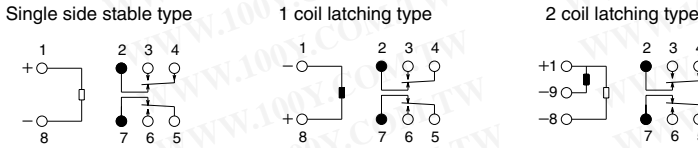

9. 2 Form A, without test button

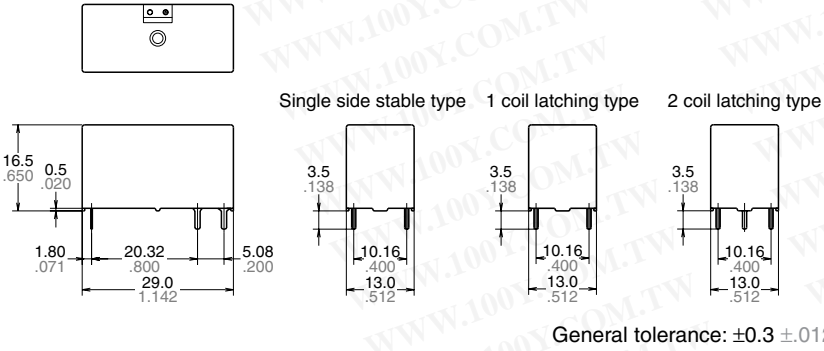

PC board pattern (Bottom view)

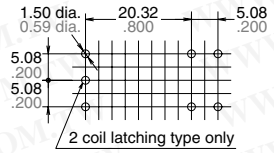

Tolerance: $\pm 0.1 \pm 0.04$

General tolerance: $\pm 0.3 \pm 0.12$

Schematic (Bottom view)

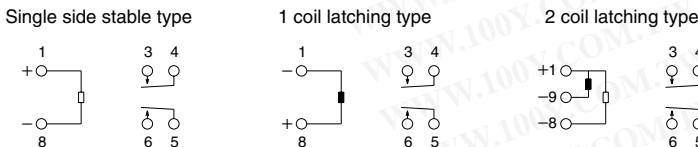

10. 2 Form B, without test button

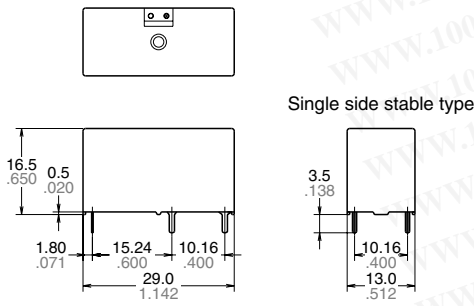

PC board pattern (Bottom view)

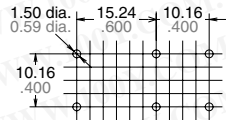

Tolerance: $\pm 0.1 \pm 0.04$

General tolerance: $\pm 0.3 \pm 0.12$

Schematic (Bottom view)

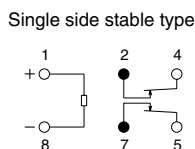

REFERENCE DATA

1. Max. switching capacity

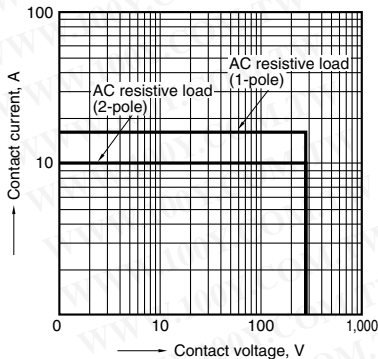

2. Temperature rise

Sample: ADJ12024, 6 pcs.
 Coil applied voltage: 0 %V, Contact current: 16 A, 20 A
 Measured portion: Contact, Ambient temperature:
 25°C 77°F, 85°C 185°F

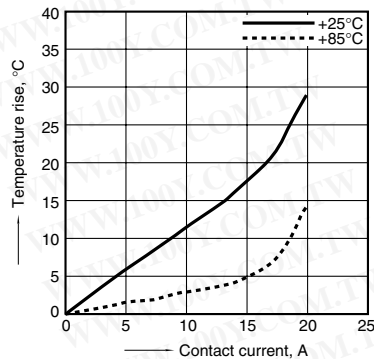

3. Coil temperature rise

Sample: ADJ56024, 6 pcs.
 Coil applied voltage: 100 %V, 130 %V of rating
 Contact current: 0 A, 10 A
 Measured portion: Inside the coil, Ambient
 temperature: Room temperature, 70°C 158°F

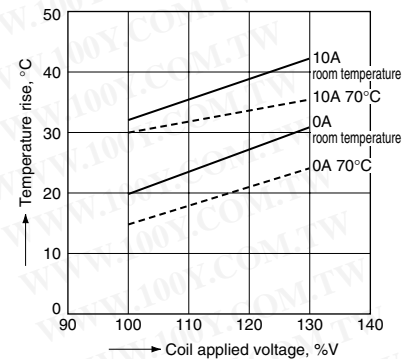

4. Set and Reset time

Sample: ADJ12024, 10 pcs
 Coil applied voltage: 80 %V, 100 %V, 120 %V of rating

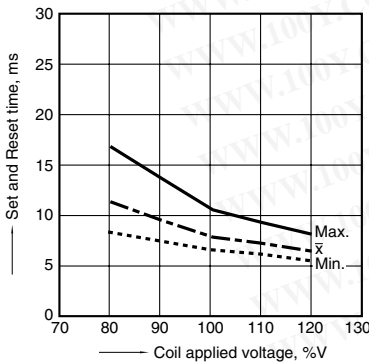

5. Ambient temperature characteristics

Sample: ADJ12024, 6 pcs
 Ambient temperature: -40°C to 85°C -40°F to 185°F

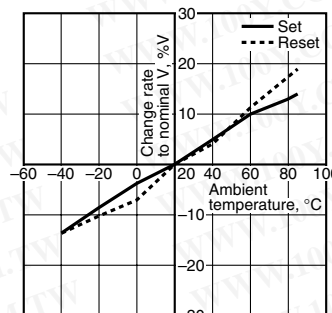

6. Influence of adjacent mounting

Sample: ADJ12024, 6 pcs
 Ambient temperature: Room temperature

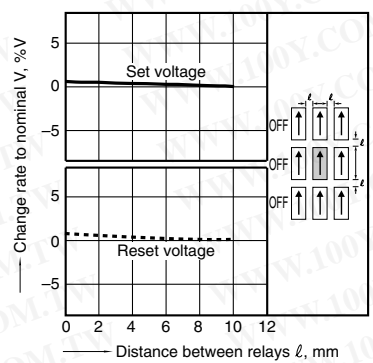

NOTES

1. Coil operating power

Pure DC current should be applied to the coil. The wave form should be rectangular. If it includes ripple, the ripple factor should be less than 5%. However, check it with the actual circuit since the characteristics may be slightly different.

2. Coil connection

When connecting coils, refer to the wiring diagram to prevent mis-operation or malfunction.

3. Soldering

We recommend the following soldering conditions

Soldering: 260°C±5°C 500°F±41°F, max. 6 s

4. Others

- 1) If the relay has been dropped, the appearance and characteristics should always be checked before use.
- 2) The cycle lifetime is defined under the standard test condition specified in the JIS* C 5442-1996 standard (temperature 15 to 35°C 59 to 95°F, humidity 25 to

85%). Check this with the real device as it is affected by coil driving circuit, load type, activation frequency, activation phase, ambient conditions and other factors.

Also, be especially careful of loads such as those listed below.

- When used for AC load-operating and the operating phase is synchronous. Rocking and fusing can easily occur due to contact shifting.
- High-frequency load-operating

When high-frequency opening and closing of the relay is performed with a load that causes arcs at the contacts, nitrogen and oxygen in the air is fused by the arc energy and HNO₃ is formed. This can corrode metal materials.

Three countermeasures for these are listed here.

- Incorporate an arc-extinguishing circuit.
 - Lower the operating frequency
 - Lower the ambient humidity
- 3) For secure operations, the voltage

applied to the coil should be nominal voltage. In addition, please note that pick-up and drop-out voltage will vary according to the ambient temperature and operation conditions.

4) Heat, smoke, and even a fire may occur if the relay is used in conditions outside of the allowable ranges for the coil ratings, contact ratings, operating cycle lifetime, and other specifications. Therefore, do not use the relay if these ratings are exceeded. Also, make sure that the relay is wired correctly.

5) Incorrect wiring may cause unexpected events or the generation of heat or flames.

6) Check the ambient conditions when storing or transporting the relays and devices containing the relays. Freezing or condensation may occur in the relay, causing functional damage. Avoid subjecting the relays to heavy loads, or strong vibration and shocks.

DJ (ADJ)

5. Usage, transport and storage conditions

1) Ambient temperature, humidity, and atmospheric pressure during usage, transport, and storage of the relay:

- Temperature:
-40 to +70°C -40 to +158°F
- Humidity: 5 to 85% RH
(Avoid freezing and condensation.)
The humidity range varies with the temperature. Use within the range indicated in the graph below.

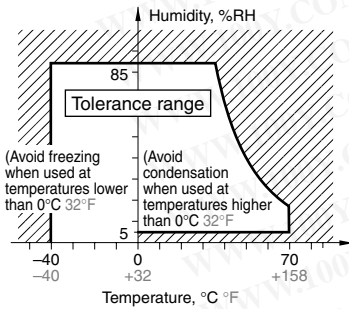

- Atmospheric pressure: 86 to 106 kPa
Temperature and humidity range for usage, transport, and storage

2) Condensation

Condensation forms when there is a sudden change in temperature under high temperature and high humidity conditions. Condensation will cause deterioration of the relay insulation.

3) Freezing

Condensation or other moisture may freeze on the relay when the temperatures is lower than 0°C 32°F. This causes problems such as sticking of movable parts or operational time lags.

4) Low temperature, low humidity environments

The plastic becomes brittle if the relay is exposed to a low temperature, low humidity environment for long periods of time.

6. Test button (manual lever) operation

The relay contacts switch over as follows:

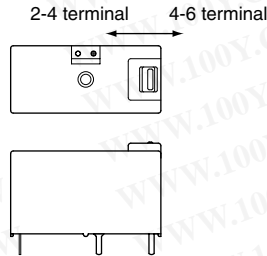

勝特力材料 886-3-5753170
勝特力電子(上海) 86-21-54151736
勝特力電子(深圳) 86-755-83298787
[Http://www.100y.com.tw](http://www.100y.com.tw)

For Cautions for Use, see Relay Technical Information.