

DATA SHEET

勝特力材料 886-3-5753170
勝特力电子(上海) 86-21-54151736
勝特力电子(深圳) 86-755-83298787
[Http://www.100y.com.tw](http://www.100y.com.tw)

74F04 Hex inverter

Product specification

1990 Oct 04

IC15 Data Handbook

Hex inverter

74F04

FEATURE

- Industrial temperature range available (-40°C to +85°C)

| TYPE | TYPICAL PROPAGATION DELAY | TYPICAL SUPPLY CURRENT (TOTAL) |
|-------|---------------------------|--------------------------------|
| 74F04 | 3.5ns | 6.9mA |

PIN CONFIGURATION

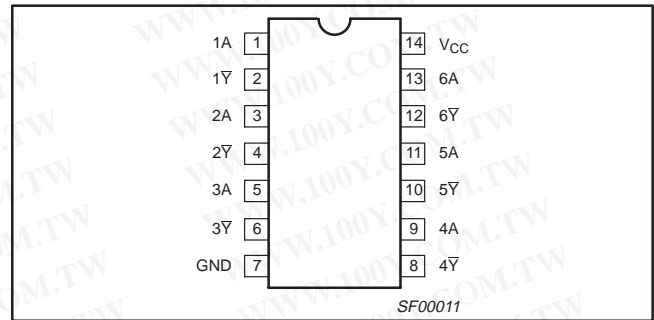

ORDERING INFORMATION

| DESCRIPTION | ORDER CODE | | PKG DWG # |
|--------------------|--|--|-----------|
| | COMMERCIAL RANGE V _{CC} = 5V ±10%, T _{amb} = 0°C to +70°C | INDUSTRIAL RANGE V _{CC} = 5V ±10%, T _{amb} = -40°C to +85°C | |
| 14-pin plastic DIP | N74F04N | I74F04N | SOT27-1 |
| 14-pin plastic SO | N74F04D | I74F04D | SOT108-1 |

INPUT AND OUTPUT LOADING AND FAN OUT TABLE

| PINS | DESCRIPTION | 74F (U.L.) HIGH/LOW | LOAD VALUE HIGH/LOW |
|------|-------------|---------------------|---------------------|
| nA | Data inputs | 1.0/1.0 | 20µA/0.6mA |
| nȳ | Data output | 50/33 | 1.0mA/20mA |

NOTE: One (1.0) FAST unit load is defined as: 20µA in the high state and 0.6mA in the low state.

LOGIC DIAGRAM

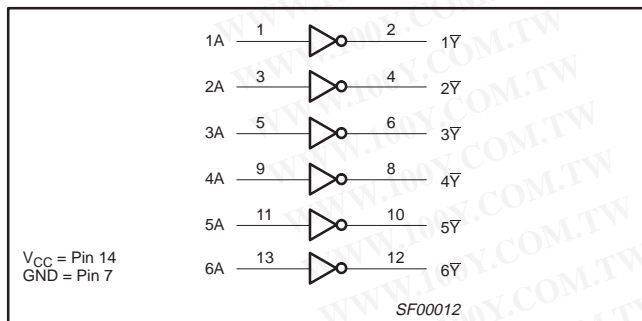

FUNCTION TABLE

| INPUTS | OUTPUT |
|--------|--------|
| A | ȳ |
| L | H |
| H | L |

NOTES:
 H = High voltage level
 L = Low voltage level

LOGIC SYMBOL

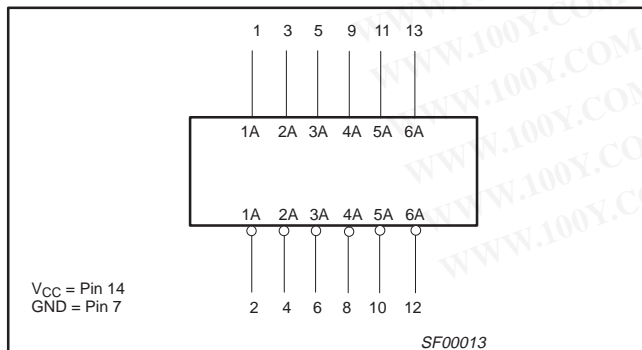

IEC/IEEE SYMBOL

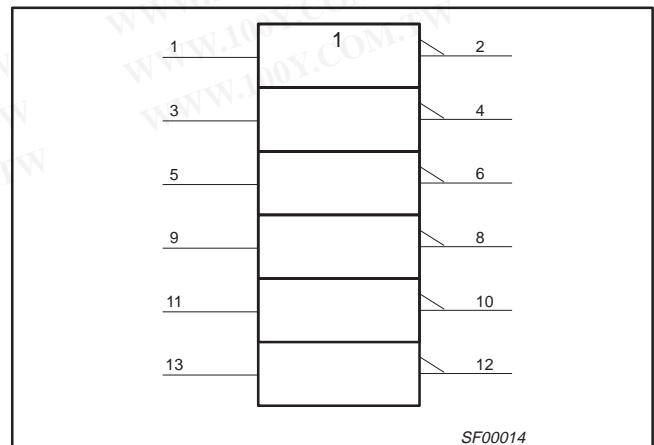

Hex inverter

勝特力材料 886-3-5753170
 勝特力电子(上海) 86-21-54151736
 勝特力电子(深圳) 86-755-83298787
 Http://www.100y.com.tw

74F04

ABSOLUTE MAXIMUM RATINGS

(Operation beyond the limit set forth in this table may impair the useful life of the device.
 Unless otherwise noted these limits are over the operating free air temperature range.)

| SYMBOL | PARAMETER | | RATING | UNIT |
|------------------|--|------------------|-------------------------|------|
| V _{CC} | Supply voltage | | -0.5 to +7.0 | V |
| V _{IN} | Input voltage | | -0.5 to +7.0 | V |
| I _{IN} | Input current | | -30 to +5 | mA |
| V _{OUT} | Voltage applied to output in high output state | | -0.5 to V _{CC} | V |
| I _{OUT} | Current applied to output in low output state | | 40 | mA |
| T _{amb} | Operating free air temperature range | Commercial range | 0 to +70 | °C |
| | | Industrial range | -40 to +85 | °C |
| T _{stg} | Storage temperature range | | -65 to +150 | °C |

RECOMMENDED OPERATING CONDITIONS

| SYMBOL | PARAMETER | LIMITS | | | UNIT |
|------------------|--------------------------------------|------------------|-----|-----|------|
| | | MIN | NOM | MAX | |
| V _{CC} | Supply voltage | 4.5 | 5.0 | 5.5 | V |
| V _{IH} | High-level input voltage | 2.0 | | | V |
| V _{IL} | Low-level input voltage | | | 0.8 | V |
| I _{IK} | Input clamp current | | | -18 | mA |
| I _{OH} | High-level output current | | | -1 | mA |
| I _{OL} | Low-level output current | | | 20 | mA |
| T _{amb} | Operating free air temperature range | Commercial range | 0 | +70 | °C |
| | | Industrial range | -40 | +85 | °C |

DC ELECTRICAL CHARACTERISTICS

(Over recommended operating free-air temperature range unless otherwise noted.)

| SYMBOL | PARAMETER | TEST CONDITIONS ¹ | LIMITS | | | UNIT | |
|-----------------|---|---|------------------------|------------------|------|------|----|
| | | | MIN | TYP ² | MAX | | |
| V _{OH} | High-level output voltage | V _{CC} = MIN, V _{IL} = MAX | ±10%V _{CC} | 2.5 | | V | |
| | | V _{IH} = MIN, I _{OH} = MAX | ±5%V _{CC} | 2.7 | 3.4 | V | |
| V _{OL} | Low-level output voltage | V _{CC} = MIN, V _{IL} = MAX | ±10%V _{CC} | | 0.30 | 0.50 | V |
| | | V _{IH} = MIN, I _{OL} = MAX | ±5%V _{CC} | | 0.30 | 0.50 | V |
| V _{IK} | Input clamp voltage | V _{CC} = MIN, I _I = I _{IK} | | -0.73 | -1.2 | V | |
| I _I | Input current at maximum input voltage | V _{CC} = MAX, V _I = 7.0V | | | 100 | μA | |
| I _{IH} | High-level input current | V _{CC} = MAX, V _I = 2.7V | | | 20 | μA | |
| I _{IL} | Low-level input current | V _{CC} = MAX, V _I = 0.5V | | | -0.6 | mA | |
| I _{OS} | Short-circuit output current ³ | V _{CC} = MAX | | -60 | -150 | mA | |
| I _{CC} | Supply current (total) | I _{CCH} V _{CC} = MAX | V _{IN} = GND | | 2.8 | 4.2 | mA |
| | | I _{CCL} V _{CC} = MAX | V _{IN} = 4.5V | | 10.2 | 15.3 | mA |

NOTES:

- For conditions shown as MIN or MAX, use the appropriate value specified under recommended operating conditions for the applicable type.
- All typical values are at V_{CC} = 5V, T_{amb} = 25°C.
- Not more than one output should be shorted at a time. For testing I_{OS}, the use of high-speed test apparatus and/or sample-and-hold techniques are preferable in order to minimize internal heating and more accurately reflect operational values. Otherwise, prolonged shorting of a high output may raise the chip temperature well above normal and thereby cause invalid readings in other parameter tests. In any sequence of parameter tests, I_{OS} tests should be performed last.

Hex inverter

74F04

勝特力材料 886-3-5753170
 勝特力电子(上海) 86-21-54151736
 勝特力电子(深圳) 86-755-83298787
[Http://www.100y.com.tw](http://www.100y.com.tw)

AC ELECTRICAL CHARACTERISTICS

| SYMBOL | PARAMETER | TEST CONDITION | LIMITS | | | | | | UNIT | |
|--------------------------------------|-----------------------------|----------------|---|------------|------------|--|------------|--|------------|-----|
| | | | V _{CC} = +5.0V T _{amb} = +25°C C _L = 50pF, R _L = 500Ω | | | V _{CC} = +5.0V ± 10% T _{amb} = 0°C to +70°C C _L = 50pF, R _L = 500Ω | | V _{CC} = +5.0V ± 10% T _{amb} = -40°C to +85°C C _L = 50pF, R _L = 500Ω | | |
| | | | MIN | TYP | MAX | MIN | MAX | MIN | | MAX |
| t _{PLH} t _{PHL} | Propagation delay A to Y | Waveform 1 | 2.4 1.5 | 3.7 3.2 | 5.0 4.3 | 2.4 1.5 | 6.0 5.3 | 1.5 1.1 | 8.0 6.5 | ns |

AC WAVEFORMS

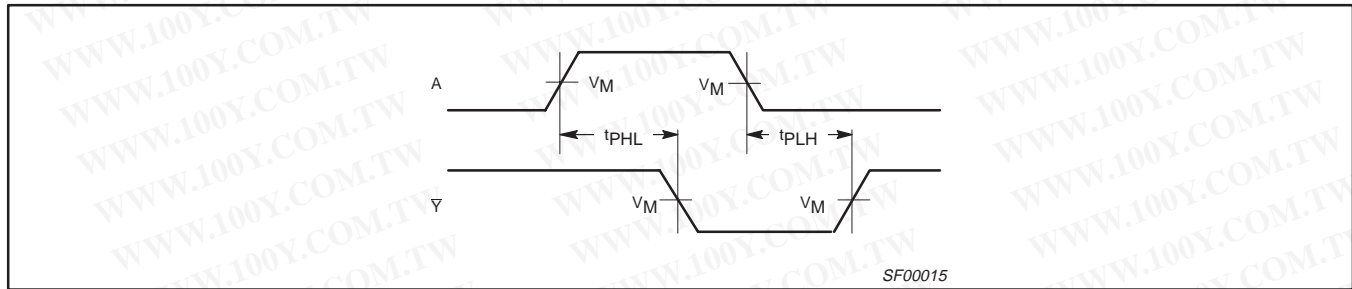

Waveform 1. Propagation delay for inverting outputs

NOTE:

For all waveforms, V_M = 1.5V.

TEST CIRCUIT AND WAVEFORMS

Test Circuit for Totem-Pole Outputs

Input Pulse Definition

DEFINITIONS:
 R_L = Load resistor; see AC ELECTRICAL CHARACTERISTICS for value.
 C_L = Load capacitance includes jig and probe capacitance; see AC ELECTRICAL CHARACTERISTICS for value.
 R_T = Termination resistance should be equal to Z_{OUT} of pulse generators.

| family | INPUT PULSE REQUIREMENTS | | | | | |
|--------|--------------------------|----------------|-----------|----------------|------------------|------------------|
| | amplitude | V _M | rep. rate | t _w | t _{TLH} | t _{THL} |
| 74F | 3.0V | 1.5V | 1MHz | 500ns | 2.5ns | 2.5ns |

SF00006

Hex inverter

74F04

DIP14: plastic dual in-line package; 14 leads (300 mil)

SOT27-1

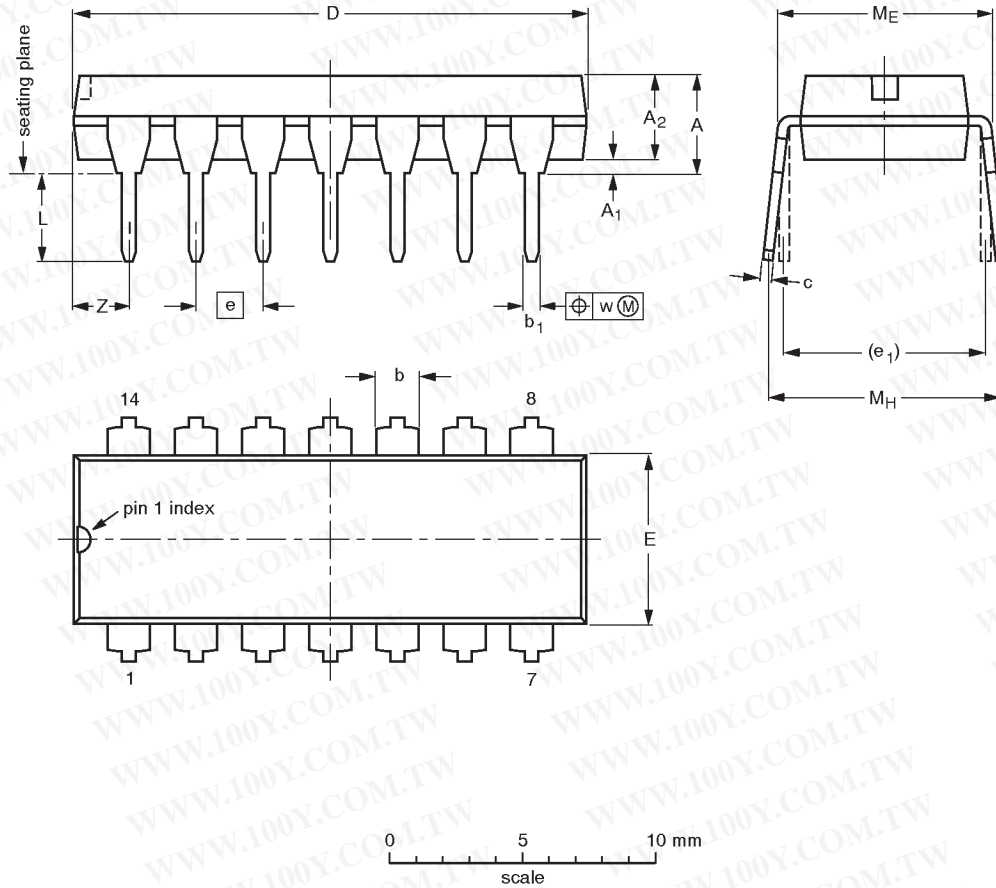

DIMENSIONS (inch dimensions are derived from the original mm dimensions)

| UNIT | A max. | A ₁ min. | A ₂ max. | b | b ₁ | c | D ⁽¹⁾ | E ⁽¹⁾ | e | e ₁ | L | M _E | M _H | w | Z ⁽¹⁾ max. |
|--------|--------|---------------------|---------------------|----------------|----------------|----------------|------------------|------------------|------|----------------|--------------|----------------|----------------|-------|-----------------------|
| mm | 4.2 | 0.51 | 3.2 | 1.73 1.13 | 0.53 0.38 | 0.36 0.23 | 19.50 18.55 | 6.48 6.20 | 2.54 | 7.62 | 3.60 3.05 | 8.25 7.80 | 10.0 8.3 | 0.254 | 2.2 |
| inches | 0.17 | 0.020 | 0.13 | 0.068 0.044 | 0.021 0.015 | 0.014 0.009 | 0.77 0.73 | 0.26 0.24 | 0.10 | 0.30 | 0.14 0.12 | 0.32 0.31 | 0.39 0.33 | 0.01 | 0.087 |

Note

1. Plastic or metal protrusions of 0.25 mm maximum per side are not included.

| OUTLINE VERSION | REFERENCES | | | EUROPEAN PROJECTION | ISSUE DATE |
|-----------------|------------|----------|------|---------------------|----------------------|
| | IEC | JEDEC | EIAJ | | |
| SOT27-1 | 050G04 | MO-001AA | | | 92-11-17 95-03-11 |

Hex inverter

74F04

勝特力材料 886-3-5753170
 勝特力电子(上海) 86-21-54151736
 勝特力电子(深圳) 86-755-83298787
[Http://www.100y.com.tw](http://www.100y.com.tw)

SO14: plastic small outline package; 14 leads; body width 3.9 mm

SOT108-1

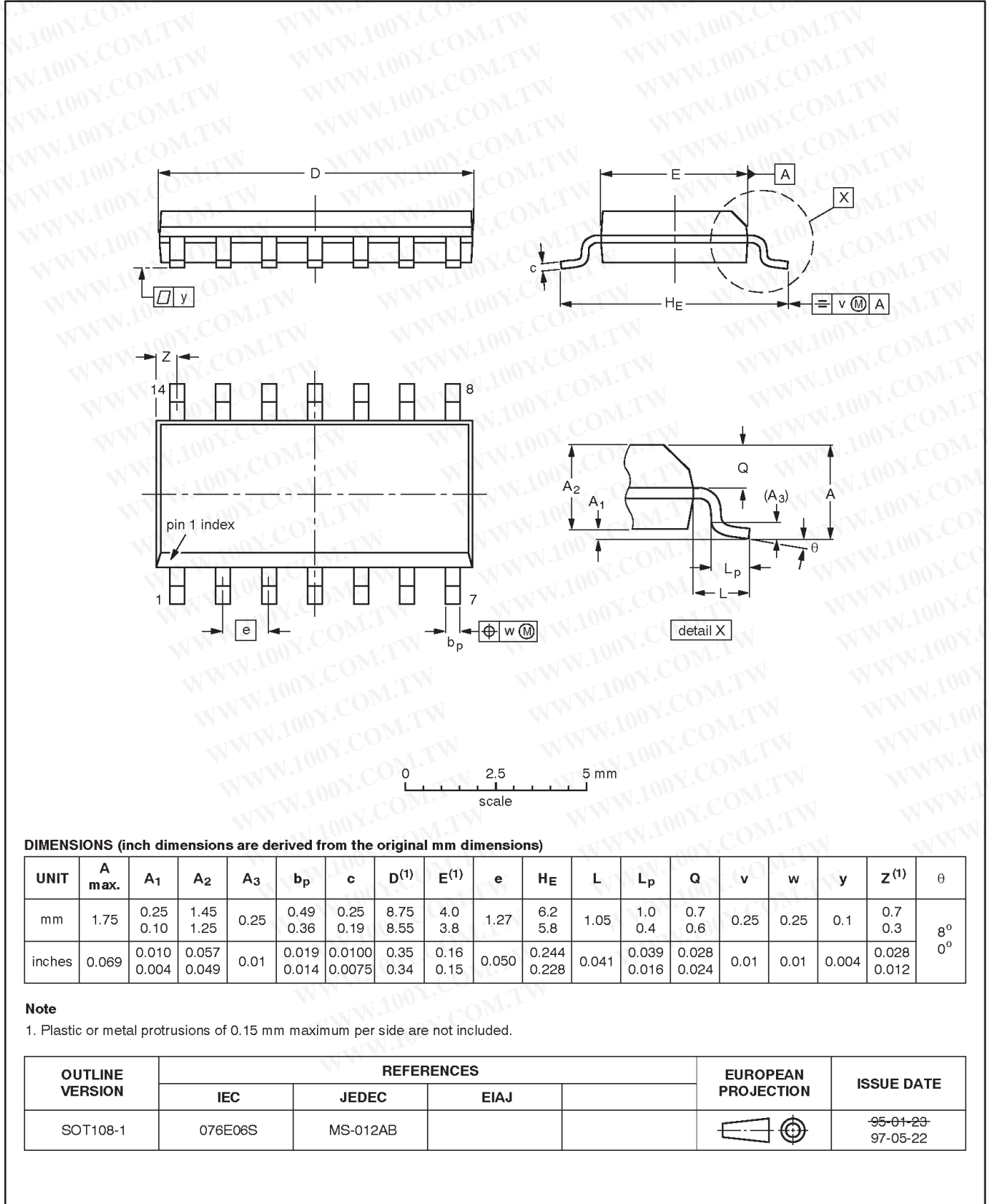

DIMENSIONS (inch dimensions are derived from the original mm dimensions)

| UNIT | A max. | A ₁ | A ₂ | A ₃ | b _p | c | D ⁽¹⁾ | E ⁽¹⁾ | e | H _E | L | L _p | Q | v | w | y | z ⁽¹⁾ | θ |
|--------|--------|----------------|----------------|----------------|----------------|------------------|------------------|------------------|-------|----------------|-------|----------------|----------------|------|------|-------|------------------|----------|
| mm | 1.75 | 0.25 0.10 | 1.45 1.25 | 0.25 | 0.49 0.36 | 0.25 0.19 | 8.75 8.55 | 4.0 3.8 | 1.27 | 6.2 5.8 | 1.05 | 1.0 0.4 | 0.7 0.6 | 0.25 | 0.25 | 0.1 | 0.7 0.3 | 8° 0° |
| inches | 0.069 | 0.010 0.004 | 0.057 0.049 | 0.01 | 0.019 0.014 | 0.0100 0.0075 | 0.35 0.34 | 0.16 0.15 | 0.050 | 0.244 0.228 | 0.041 | 0.039 0.016 | 0.028 0.024 | 0.01 | 0.01 | 0.004 | 0.028 0.012 | |

Note

1. Plastic or metal protrusions of 0.15 mm maximum per side are not included.

| OUTLINE VERSION | REFERENCES | | | EUROPEAN PROJECTION | ISSUE DATE |
|-----------------|------------|----------|------|---------------------|----------------------|
| | IEC | JEDEC | EIAJ | | |
| SOT108-1 | 076E06S | MS-012AB | | | 95-01-29 97-05-22 |

Hex inverter

74F04

NOTES

Hex inverter

74F04

勝特力材料 886-3-5753170
 勝特力电子(上海) 86-21-54151736
 勝特力电子(深圳) 86-755-83298787
[Http://www.100y.com.tw](http://www.100y.com.tw)

Data sheet status

| Data sheet status | Product status | Definition [1] |
|---------------------------|----------------|--|
| Objective specification | Development | This data sheet contains the design target or goal specifications for product development. Specification may change in any manner without notice. |
| Preliminary specification | Qualification | This data sheet contains preliminary data, and supplementary data will be published at a later date. Philips Semiconductors reserves the right to make changes at any time without notice in order to improve design and supply the best possible product. |
| Product specification | Production | This data sheet contains final specifications. Philips Semiconductors reserves the right to make changes at any time without notice in order to improve design and supply the best possible product. |

[1] Please consult the most recently issued datasheet before initiating or completing a design.

Definitions

Short-form specification — The data in a short-form specification is extracted from a full data sheet with the same type number and title. For detailed information see the relevant data sheet or data handbook.

Limiting values definition — Limiting values given are in accordance with the Absolute Maximum Rating System (IEC 134). Stress above one or more of the limiting values may cause permanent damage to the device. These are stress ratings only and operation of the device at these or at any other conditions above those given in the Characteristics sections of the specification is not implied. Exposure to limiting values for extended periods may affect device reliability.

Application information — Applications that are described herein for any of these products are for illustrative purposes only. Philips Semiconductors make no representation or warranty that such applications will be suitable for the specified use without further testing or modification.

Disclaimers

Life support — These products are not designed for use in life support appliances, devices or systems where malfunction of these products can reasonably be expected to result in personal injury. Philips Semiconductors customers using or selling these products for use in such applications do so at their own risk and agree to fully indemnify Philips Semiconductors for any damages resulting from such application.

Right to make changes — Philips Semiconductors reserves the right to make changes, without notice, in the products, including circuits, standard cells, and/or software, described or contained herein in order to improve design and/or performance. Philips Semiconductors assumes no responsibility or liability for the use of any of these products, conveys no license or title under any patent, copyright, or mask work right to these products, and makes no representations or warranties that these products are free from patent, copyright, or mask work right infringement, unless otherwise specified.

Philips Semiconductors
 811 East Arques Avenue
 P.O. Box 3409
 Sunnyvale, California 94088-3409
 Telephone 800-234-7381

© Copyright Philips Electronics North America Corporation 1998
 All rights reserved. Printed in U.S.A.

print code

Date of release: 10-98

Document order number:

9397-750-05053

Let's make things better.