

## Switch-Mode 1-Cell Li+ Chargers

### General Description

The MAX1925/MAX1926 single-cell lithium-ion (Li+) switch-mode battery chargers use an external PMOS pass element step-down configuration. Charge current is programmable, and an external capacitor sets the maximum charge time.

Additional features include automatic input power detection (ACON output), logic-controlled enable, and temperature monitoring with an external thermistor. The MAX1925 disables charging for inputs greater than 6.1V, while the MAX1926 charges for inputs between 4.25V and 12V.

The MAX1925/MAX1926 feature two precondition levels to restore near-dead cells. The devices source 4mA to a cell that is below 2V while sourcing C/10 to a cell between 2V and 3V. Full charge current is then applied above 3V. A CHG output drives an LED to indicate charging (LED on) and fault conditions (LED blinking).

The MAX1925/MAX1926 are available in a 12-pin 4mm x 4mm thin QFN package and are specified over the extended temperature range (-40°C to +85°C). An evaluation kit is available to speed design.

### Applications

Digital Cameras  
 Self-Charging Battery Packs  
 PDAs  
 Cradle Chargers

### Pin Configuration

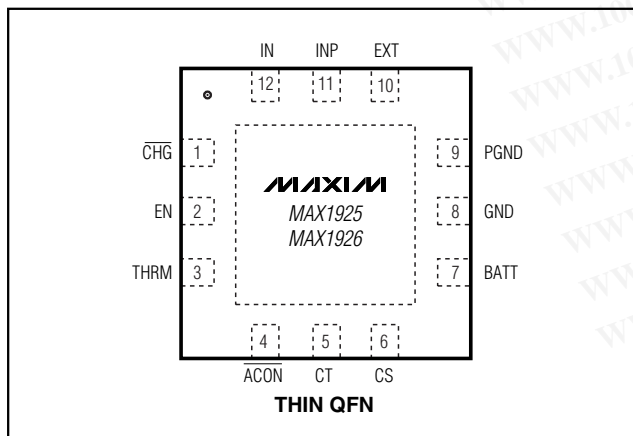

### Features

- ◆ Small (4mm × 4mm) Package
- ◆ 4.25V to 12V Input Range (MAX1926)
- ◆ Overvoltage Lockout at 6.1V (MAX1925)
- ◆ ±0.75% Battery Regulation Voltage
- ◆ Set Charge Current with One Resistor
- ◆ Automatic Input Power Sense
- ◆ LED (or Logic-Out) Charge Status and Fault Indicator
- ◆ Programmable Safety Timer
- ◆ Autorestart at Cell = 4V
- ◆ Thermistor Monitor Input

### Ordering Information

PART	TEMP RANGE	PIN-PACKAGE	INPUT CHARGING RANGE
MAX1925ETC	-40°C to +85°C	12 Thin QFN 4mm x 4mm	4.5V to 6.1V
MAX1926ETC	-40°C to +85°C	12 Thin QFN 4mm x 4mm	4.25V to 12V

### Typical Operating Circuit

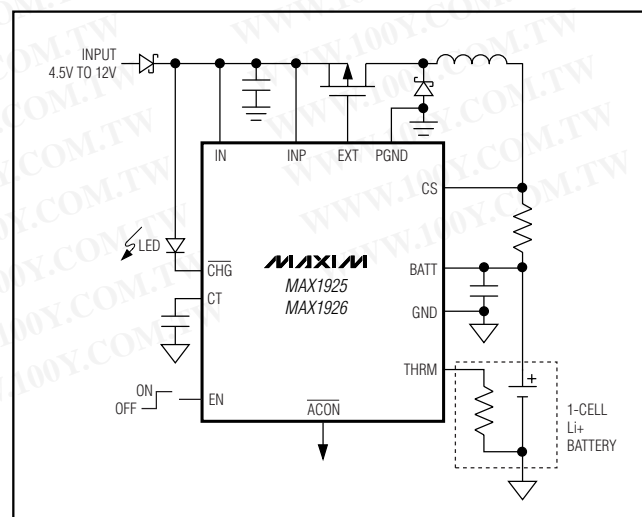

# Switch-Mode 1-Cell Li+ Chargers

## ABSOLUTE MAXIMUM RATINGS

IN, INP, $\overline{ACON}$ to GND	-0.3V to +14V	Continuous Power Dissipation ( $T_A = +70^\circ\text{C}$ )	
CHG, EXT to PGND	-0.3V to ( $V_{INP} + 0.3V$ )	Exposed Paddle Soldered to Board	
CS, BATT, EN, THRM to GND	-0.3V to +6V	(derate 16.9mW/°C above +70°C)	1349mW
CT to GND	-0.3V to +4V	Exposed Paddle Unsoldered	
EN, THRM, CT to IN	-14V to +0.3V	(derate 9mW/°C above +70°C)	721mW
INP to IN	-0.3V to +0.3V	Operating Temperature Range	-40°C to +85°C
PGND to GND	-0.3V to +0.3V	Junction Temperature	+150°C
CS to BATT	-0.3V to +0.3V	Storage Temperature Range	-65°C to +150°C
EXT Continuous RMS Current	$\pm 100\text{mA}$	Lead Temperature (soldering, 10s)	+300°C

Stresses beyond those listed under "Absolute Maximum Ratings" may cause permanent damage to the device. These are stress ratings only, and functional operation of the device at these or any other conditions beyond those indicated in the operational sections of the specifications is not implied. Exposure to absolute maximum rating conditions for extended periods may affect device reliability.

## ELECTRICAL CHARACTERISTICS

( $V_{PGND} = V_{GND} = 0$ ,  $V_{INP} = V_{IN} = V_{CHG} = 5V$ ,  $V_{BATT} = V_{CS} = V_{EN} = 4V$ , THRM = 10k $\Omega$  to GND,  $C_{CT} = 100\text{nF}$ ,  $T_A = 0^\circ\text{C}$  to +85°C, unless otherwise noted. Typical values are at  $T_A = +25^\circ\text{C}$ .)

PARAMETER	CONDITIONS	MIN	TYP	MAX	UNITS	
Supply Voltage Range	$V_{INP}$ , $V_{IN}$ (MAX1925 does not charge above 6.1V)	4.5		12.0	V	
$\overline{ACON}$ Trip Point	$V_{INP}$ , $V_{IN}$ rising	MAX1925	4.30	4.50	4.78	V
		MAX1926	4.00	4.25	4.50	
	$V_{INP}$ , $V_{IN}$ falling	MAX1925	4.17	4.30	4.43	
		MAX1926	3.90	4.15	4.40	
INP, IN Shutdown Threshold	MAX1925	Rising	5.8		6.4	V
		Falling	5.3		5.9	
EN Input Resistance	MAX1926 internally pulled up to 3V	125	300	550	k $\Omega$	
EN Leakage Current	MAX1925	-1		+1	$\mu\text{A}$	
EN Logic Input High Threshold		2			V	
EN Logic Input Low Threshold				0.8	V	
BATT + CS Input Current (Total Current into BATT and CS)	DONE state, $V_{BATT} = 4.1V$		25	50	$\mu\text{A}$	
	EN = GND (Note 1)		2	10		
	$V_{BATT} = V_{INP} = V_{IN} = 4V$ , shutdown (Note 1)		2	10		
CS Input Current	Charging		39		$\mu\text{A}$	
	EN = GND		5	8	mA	
IN + INP Total Input Current	$V_{BATT} = V_{INP} = V_{IN} = 4V$ , shutdown		2	10	$\mu\text{A}$	
	$V_{BATT} = 4.1V$ ; charging			10	mA	
	$V_{BATT} = 4.3V$ ; done		5	8		
<b>VOLTAGE LOOP</b>						
Voltage Loop Set Point		4.1685	4.2000	4.2315	V	
Voltage Loop Hysteresis			15		mV	
BATT Prequal1 Voltage Threshold		1.9	2	2.1	V	
BATT Prequal2 Voltage Threshold		2.85	3	3.15	V	

# Switch-Mode 1-Cell Li+ Chargers

MAX1925/MAX1926

## ELECTRICAL CHARACTERISTICS (continued)

(VPGND = V<sub>GND</sub> = 0, V<sub>INP</sub> = V<sub>IN</sub> = V<sub>CHG</sub> = 5V, V<sub>BATT</sub> = V<sub>CS</sub> = V<sub>EN</sub> = 4V, THRM = 10kΩ to GND, C<sub>CT</sub> = 100nF, T<sub>A</sub> = 0°C to +85°C, unless otherwise noted. Typical values are at T<sub>A</sub> = +25°C.)

PARAMETER	CONDITIONS	MIN	TYP	MAX	UNITS	
Restart Threshold	Charging restarts when BATT falls to this point	3.92	4.00	4.08	V	
BATT Voltage Fault Threshold	If BATT exceeds this threshold, EXT is high (external MOSFET is off) and CHG blinks	4.275	4.350	4.425	V	
<b>CURRENT LOOP</b>						
CS - BATT Sense Threshold	V <sub>CS</sub> - V <sub>BATT</sub> , average value	132	142	152	mV	
	Rise/fall hysteresis	30				
Prequal1 Charge Current	V <sub>BATT</sub> < 2V	3	4	6	mA	
Prequal2 CS - BATT Sense Threshold	Average value, 2V < V <sub>BATT</sub> < 3V (charge current is C/10)	14			mV	
	Rise/fall hysteresis, 2V < V <sub>BATT</sub> < 3V	12				
Current Threshold for Full-Battery Indication	I <sub>LOAD</sub> falling, as percentage of fast charge current	6	12	20	%	
<b>DRIVER FUNCTIONS</b>						
EXT Sink/Source Current		1			A	
EXT On-Resistance	EXT high or low	5			12	Ω
Nominal Switching Frequency	V <sub>BATT</sub> = 3.6V, L = 10μH	235			kHz	
<b>TIMER FUNCTIONS</b>						
Full-Time Timeout - t <sub>FULL</sub>	C <sub>CT</sub> = 100nF	3.02			hours	
Prequal1 Timeout	C <sub>CT</sub> = 100nF	t <sub>FULL</sub> /1088 (10s)			s	
Prequal2 Timeout	C <sub>CT</sub> = 100nF	t <sub>FULL</sub> /17 (10.67 min)			min	
Timer Accuracy	C <sub>CT</sub> = 100nF for 3 hours	-15			+15	%
CHG Output Low Current	V <sub>CHG</sub> = 1V	7	10	14	mA	
CHG Output High Leakage Current	V <sub>CHG</sub> = 12V	1			μA	
CHG Blink Rate - Fault	Fault state (50% duty cycle), C <sub>CT</sub> = 100nF	0.5			Hz	
ACON High Leakage	V <sub>ACON</sub> = 12V	0.01			1.00	μA
ACON Sink Current	V <sub>ACON</sub> = 0.4V	2			mA	
<b>THERMISTOR MONITOR (Note 2)</b>						
THRM Sense Current for Hot Qualification		344.1	352.9	361.7	μA	
THRM Sense Current for Cold Qualification		47.58	48.80	50.02	μA	
THRM Sense-Voltage Trip Point	(Note 3)	1.386	1.400	1.414	V	

# Switch-Mode 1-Cell Li+ Chargers

勝特力材料 886-3-5753170  
 勝特力电子(上海) 86-21-54151736  
 勝特力电子(深圳) 86-755-83298787  
[Http://www.100y.com.tw](http://www.100y.com.tw)

## ELECTRICAL CHARACTERISTICS

(VPGND = V<sub>GND</sub> = 0, V<sub>INP</sub> = V<sub>IN</sub> = V<sub>CHG</sub> = 5V, V<sub>BATT</sub> = V<sub>CS</sub> = V<sub>EN</sub> = 4V, THRM = 10kΩ to GND, C<sub>CT</sub> = 100nF, T<sub>A</sub> = -40°C to +85°C, unless otherwise noted. Typical values are at T<sub>A</sub> = +25°C.) (Note 4)

PARAMETER	CONDITIONS	MIN	TYP	MAX	UNITS
Supply Voltage Range	V <sub>INP</sub> , V <sub>IN</sub> (MAX1925 does not charge above 6.1V)	4.5		12.0	V
ACON Trip point	V <sub>INP</sub> , V <sub>IN</sub> rising	MAX1925		4.30	V
		MAX1926		4.0	
	V <sub>INP</sub> , V <sub>IN</sub> falling	MAX1925		4.17	
		MAX1926		3.9	
INP, IN Shutdown Threshold	MAX1925	Rising		5.8	V
		Falling		5.3	
EN Input Resistance	MAX1926 internally pulled up to 3V	125		550	kΩ
EN Leakage Current	MAX1925	-1		+1	μA
EN Logic Input High Threshold		2			V
EN Logic Input Low Threshold				0.8	V
BATT + CS Input Current (Total Current into BATT and CS)	DONE State, V <sub>BATT</sub> = 4.1V			50	μA
	EN = GND (Note 2)			10	
	V <sub>BATT</sub> = V <sub>INP</sub> = V <sub>IN</sub> = 4V, shutdown (Note 1)			10	
IN + INP Total Input Current	EN = GND			8	mA
	V <sub>BATT</sub> = V <sub>INP</sub> = V <sub>IN</sub> = 4V, shutdown			10	
	V <sub>BATT</sub> = 4.1V, charging			10	mA
	V <sub>BATT</sub> = 4.3V, done			8	
<b>VOLTAGE LOOP</b>					
Voltage Loop Set Point		4.158		4.242	V
BATT Prequal1 Voltage Threshold		1.9		2.1	V
BATT Prequal2 Voltage Threshold		2.85		3.15	V
Restart Threshold	Charging restarts when BATT falls to this point	3.92		4.08	V
BATT Voltage Fault Threshold	If BATT exceeds this threshold, EXT is high (external MOSFET is off) and CHG blinks	4.275		4.425	V
<b>CURRENT LOOP</b>					
CS - BATT Sense Threshold	V <sub>CS</sub> - V <sub>BATT</sub> , average value	127		157	mV
Prequal1 Charge Current	V <sub>BATT</sub> < 2V	3		6	mA
Current Threshold for Full-Battery Indication	I <sub>LOAD</sub> falling, as percentage of fast charge current	4		20	%
<b>DRIVER FUNCTIONS</b>					
EXT On-Resistance	EXT high or low			12	Ω
<b>TIMER FUNCTIONS</b>					
Timer Accuracy	C <sub>CT</sub> = 100nF for 3 hours	-16		+16	%
CHG Output Low Current	V <sub>CHG</sub> = 1V	7		14	mA

## Switch-Mode 1-Cell Li+ Chargers

### ELECTRICAL CHARACTERISTICS (continued)

(VPGND = VGND = 0, VINP = VIN = VCHG = 5V, VBATT = VCS = VEN = 4V, THRM = 10kΩ to GND, CCT = 100nF, TA = -40°C to +85°C, unless otherwise noted. Typical values are at TA = +25°C.) (Note 4)

PARAMETER	CONDITIONS	MIN	TYP	MAX	UNITS
CHG Output High Leakage Current	VCHG = 12V			1	μA
ACON High Leakage	VACON = 12V			1	μA
ACON Sink Current	VACON = 0.4V	2			mA
<b>THERMISTOR MONITOR</b>					
THRM Sense Current for Hot Qualification		342		363	μA
THRM Sense Current for Cold Qualification		47.3		50.3	μA
THRM Sense-Voltage Trip Point	(Note 3)	1.379		1.421	V

**Note 1:** When the AC adapter is unplugged or if the charger is shut down, BATT drain is less than 10μA.

**Note 2:** These specifications guarantee the thermistor interface detects a fault at the correct temperature (0°C to +5°C cold temperature and 45°C to +50°C hot temperature) with Philips NTC Thermistor Series 640-6, 2322-640-63103, 10.0K at +25°C, ±5% (or equivalent).

**Note 3:** A fault is generated if VTHRM lower than 1.4V during the cold test or higher than 1.4V during the hot test. Hot and cold tests occur on alternate CT clock transitions.

**Note 4:** Specifications to -40°C are guaranteed by design and not production tested.

勝特力材料 886-3-5753170  
 勝特力电子(上海) 86-21-54151736  
 勝特力电子(深圳) 86-755-83298787  
[Http://www.100y.com.tw](http://www.100y.com.tw)

# Switch-Mode 1-Cell Li+ Chargers

## Typical Operating Characteristics

(Circuit of Figure 1,  $V_{SUPPLY} = 5V$ ,  $V_{BATT} = 4V$ ,  $T_A = +25^\circ C$ , unless otherwise noted.)

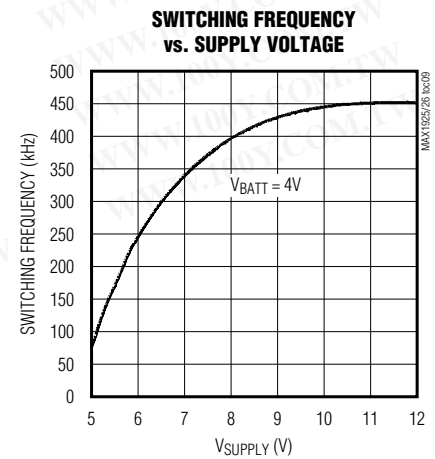
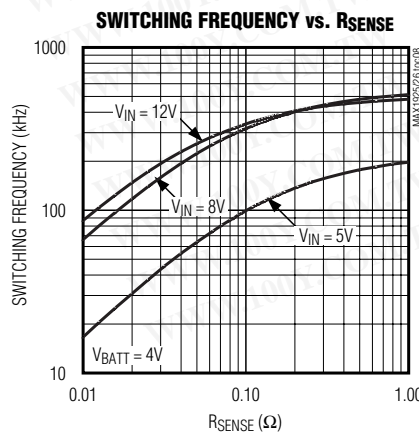
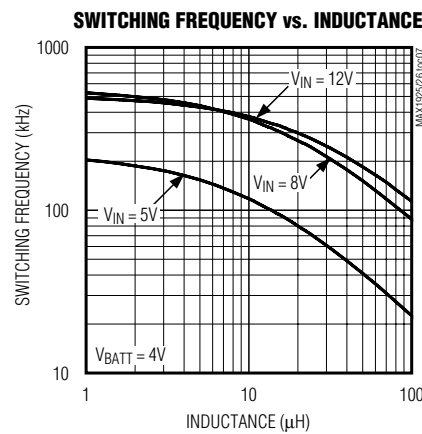
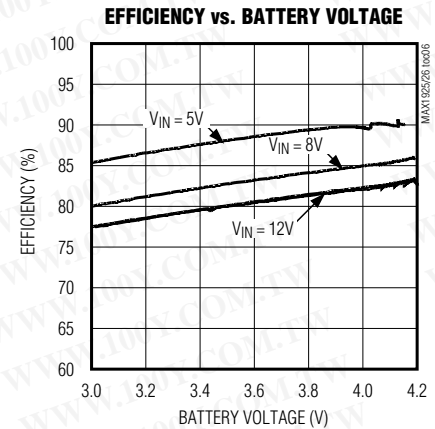
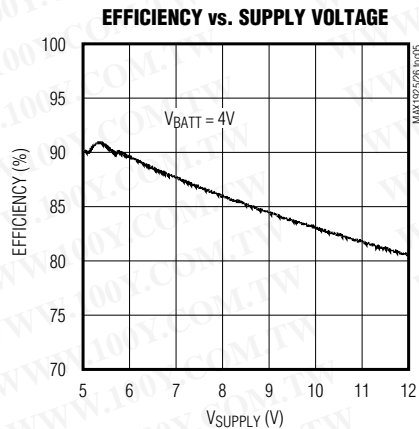
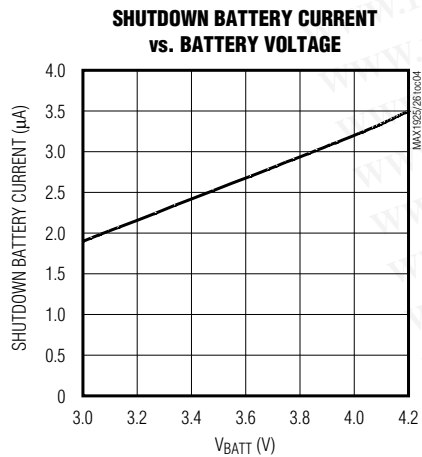
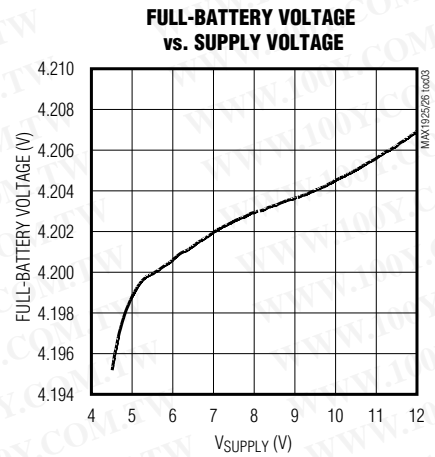
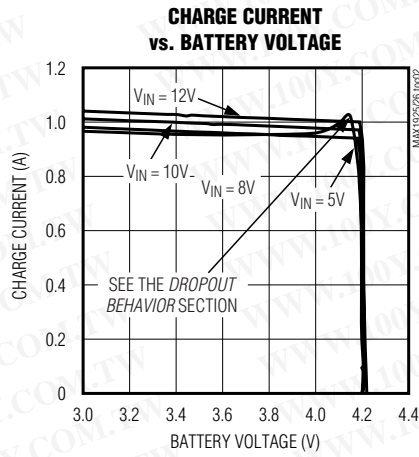
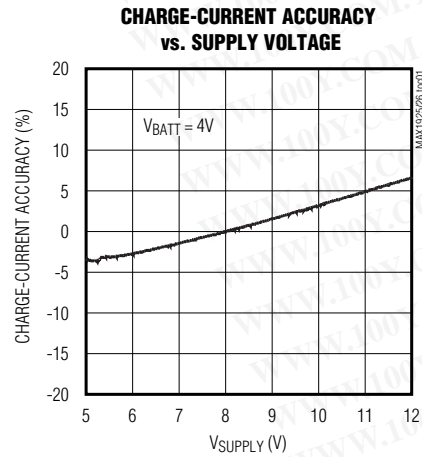

# Switch-Mode 1-Cell Li+ Chargers

## Typical Operating Characteristics (continued)

(Circuit of Figure 1,  $V_{SUPPLY} = 5V$ ,  $V_{BATT} = 4V$ ,  $T_A = +25^\circ C$ , unless otherwise noted.)

MAX1925/MAX1926

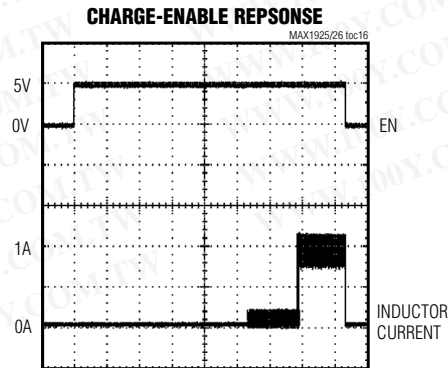
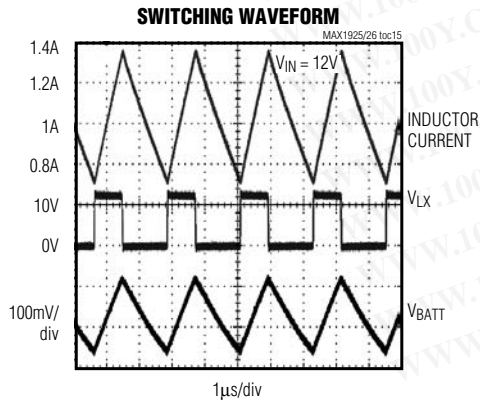
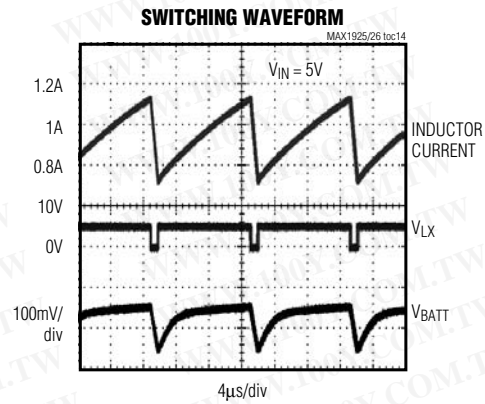
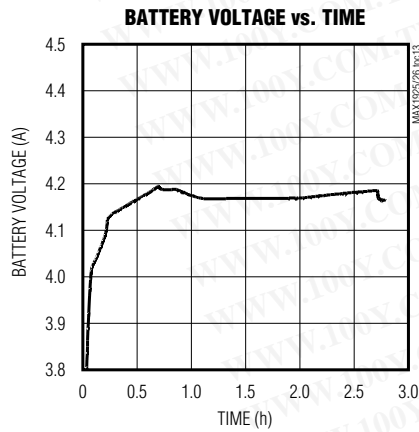
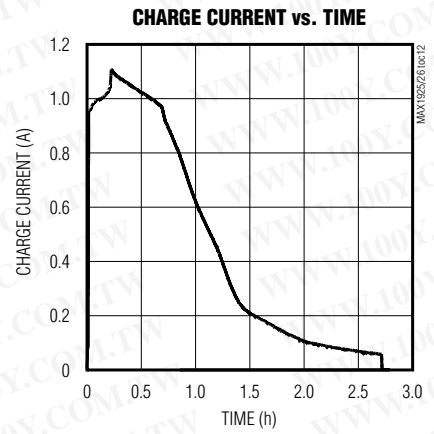
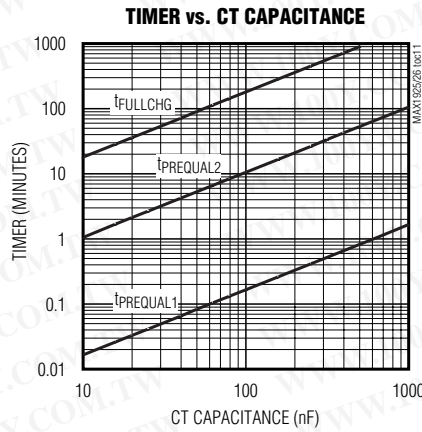
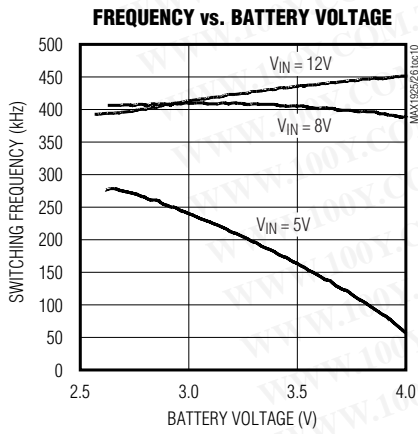

# Switch-Mode 1-Cell Li+ Chargers

勝特力材料 886-3-5753170  
 勝特力电子(上海) 86-21-54151736  
 勝特力电子(深圳) 86-755-83298787  
[Http://www.100y.com.tw](http://www.100y.com.tw)

## Pin Description

PIN	NAME	FUNCTION
1	CHG	Charge Status LED Driver. Open-drain LED driver sinks 10mA when the MAX1925/MAX1926 are charging. CHG also blinks at a 0.5Hz rate during fault states (see the <i>Timing</i> section). High impedance when charger is in shutdown. See Tables 1 and 2.
2	EN	Enable. Drive EN high to enable charger. Logic level input for normal ON/OFF control. In the MAX1926 EN is internally pulled up to 3V with a 300kΩ resistor.
3	THRM	Thermistor Input. Monitors external thermistor (10kΩ at +25°C). When external temperature is lower than 0°C or above +50°C, charging stops and the charger enters fault mode. Charging resumes when the temperature returns to normal. During a temperature fault the MAX1926 blinks the CHG output, while MAX1925 CHG remains off (high).
4	ACON	Power-OK Indicator Output. Open-drain output goes low when AC adapter power is valid. See Table 2 for ACON states.
5	CT	Timing Capacitor Connection. Connect timer cap to program full-charge safety timeout interval and prequalification fault times. Timeouts with C <sub>CT</sub> = 100nF are: Full Timer (t <sub>FULLCHG</sub> ): 3 hours—If FASTCHG is not completed within this time a fault is asserted. Prequal2 Timer: Full Timer/17 (10.67 min) Prequal1 Timer: Full Timer/1088 (10s)
6	CS	Charge-Current Sense Input. 142mV nominal regulation threshold. CS is high impedance during shutdown.
7	BATT	Battery-Sense Input. Also negative side of charge-current sense. BATT is high impedance during shutdown.
8	GND	Ground
9	PGND	Power Ground
10	EXT	PMOS Gate-Driver Output. Drives gate of external PMOS switching transistor from IN to GND. When using the MAX1926, ensure that the MOSFET V <sub>GS</sub> rating is greater than V <sub>IN</sub> .
11	INP	Supply Voltage Input
12	IN	Supply-Sense Input. Connect IN to INP.

# Switch-Mode 1-Cell Li+ Chargers

MAX1925/MAX1926

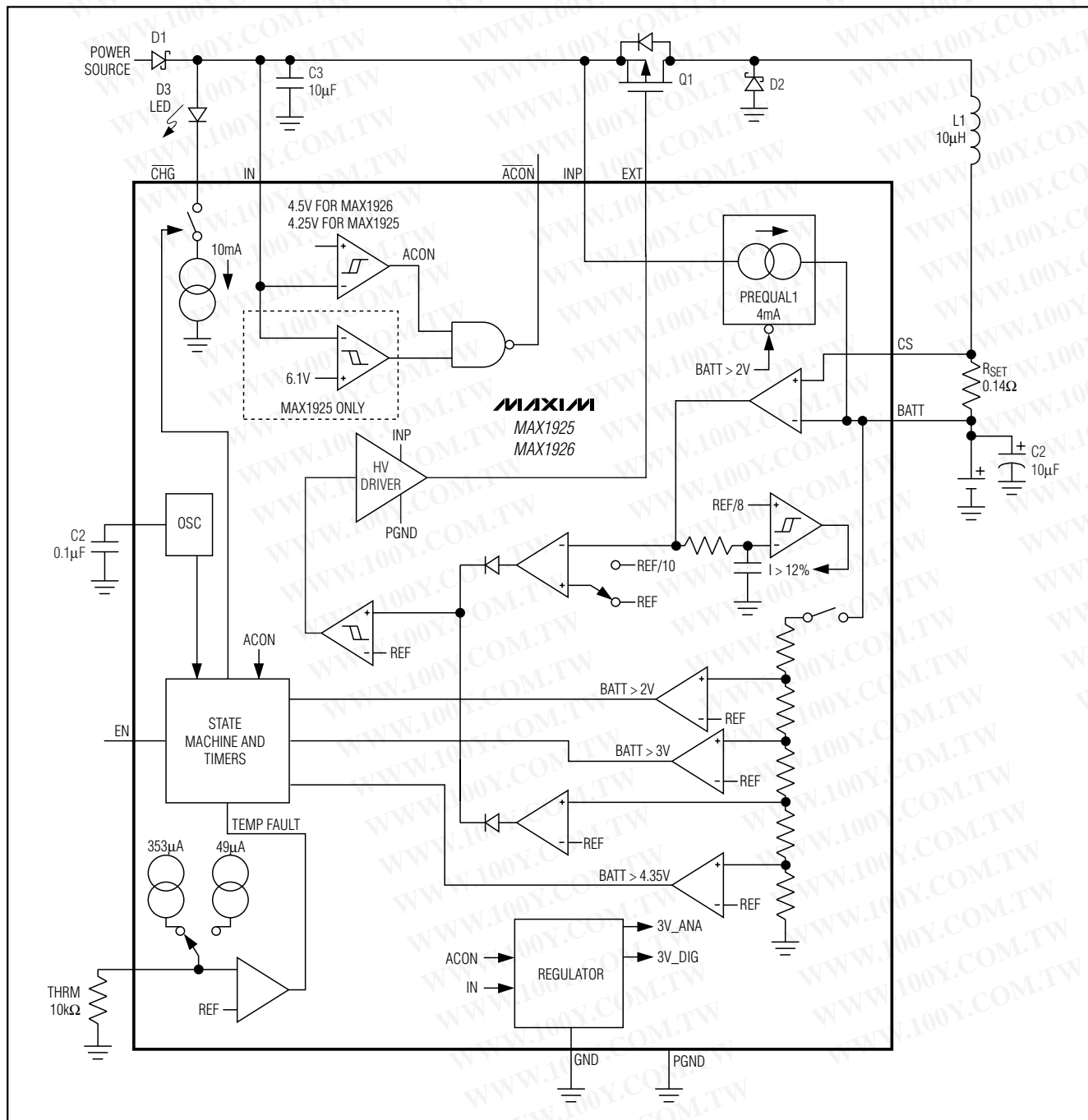

Figure 1. Functional Diagram

# Switch-Mode 1-Cell Li+ Chargers

MAX1925/MAX1926

## Detailed Description

The MAX1925/MAX1926 switch-mode battery chargers form a complete solution for a single-cell Li+ battery. The devices include battery undervoltage/overvoltage fault protection. The MAX1925/MAX1926 use EN and THRM for shutdown, battery detection, and temperature monitoring. The devices provide outputs to indicate charge status (CHG) and presence of input power (ACON).

The MAX1925/MAX1926 include two prequalification modes that must be passed before the charger enters the fast-charge state. During fast charge, the charger operates initially in constant-current mode until the battery voltage reaches 4.2V. When the battery voltage has reached 4.2V, the charger operates in constant-voltage mode, the charger acts as a hysteretic current source, controlling the inductor's peak and valley currents. In constant-voltage

mode, the charger regulates the peak and valley of the output ripple.

## Charge Cycle

The MAX1925/MAX1926 initiate PREQUAL when one of the following occurs:

- When an external power source is connected
- The cell voltage falls to 4V after charging is finished
- EB is toggled
- Input power is cycled

Some Li+ cells can be damaged when fast-charged from a completely dead state. Moreover, an over-discharged cell may indicate a dangerous abnormal cell condition. As a built-in safety feature, the MAX1925/MAX1926 use a two-level prequalification charge to determine if it is safe to charge. When the cell voltage is less than 2V, the cell is charged from an internal

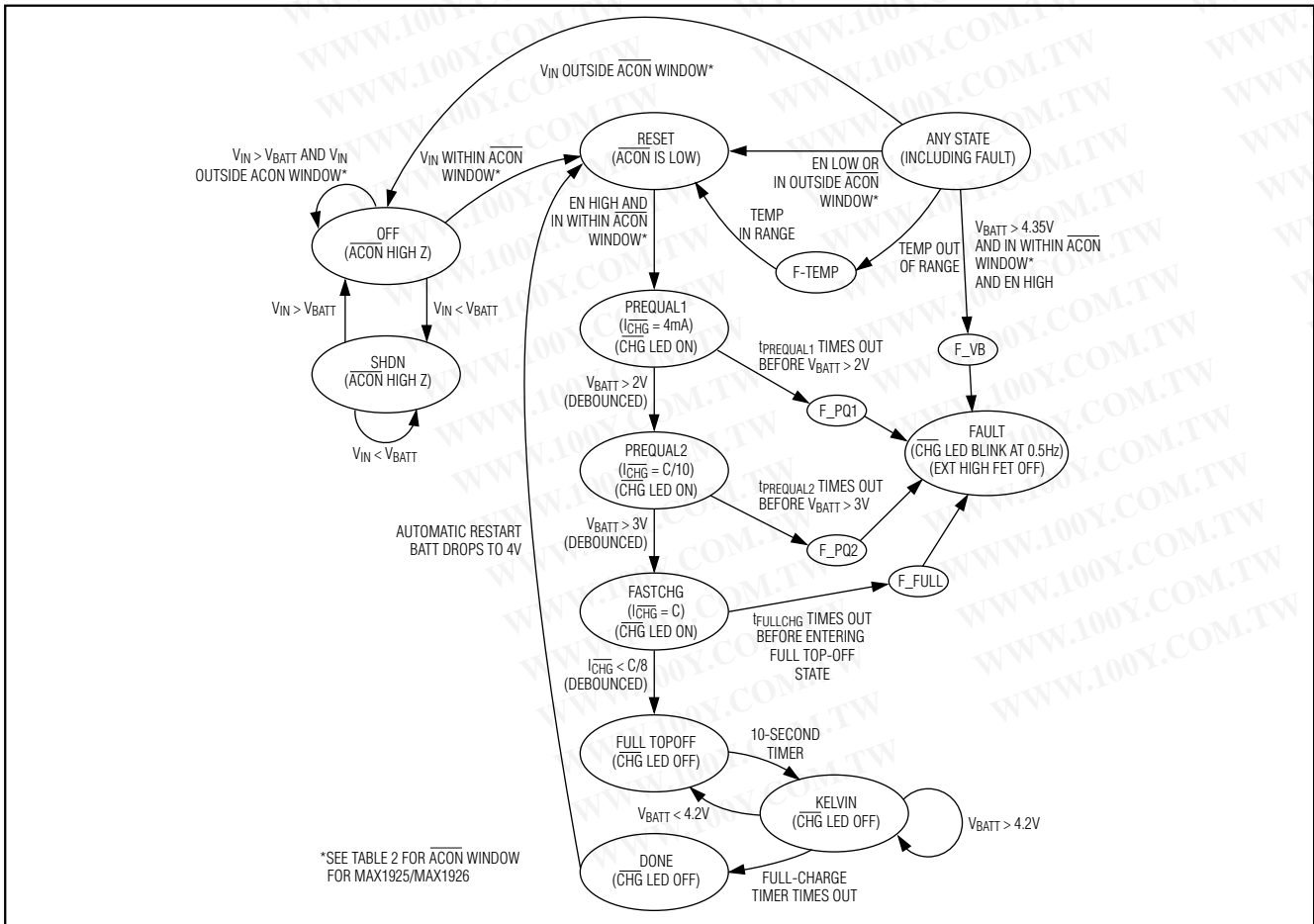

Figure 2. MAX1925/MAX1926 State Diagram

## Switch-Mode 1-Cell Li+ Chargers

MAX1925/MAX1926

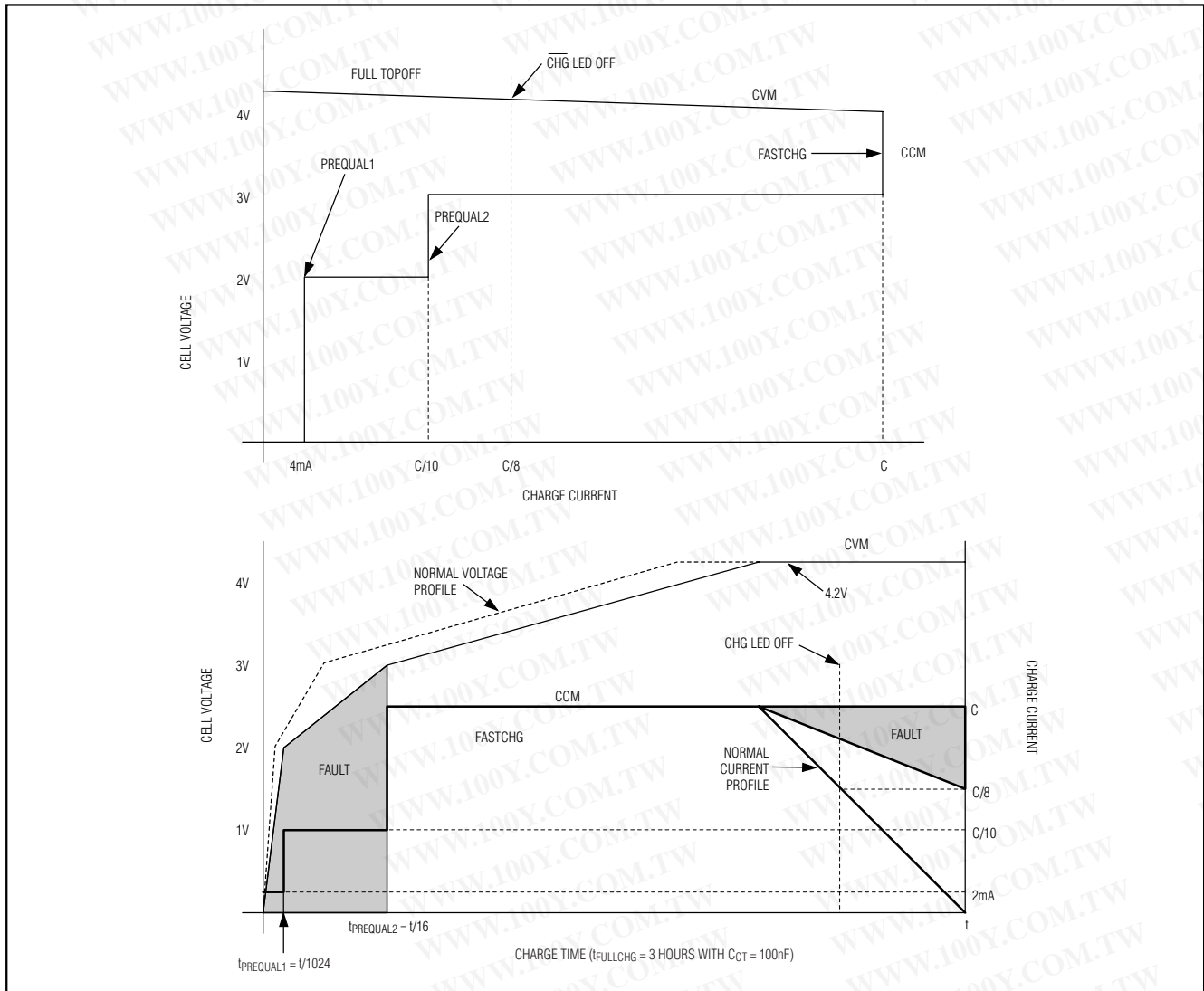

Figure 3. Charging Current and Voltage Timing Diagrams

linear 4mA current source (PREQUAL1). When the cell voltage exceeds 2V, the cell is charged with 10% of the programmed fast-charge current ( $I_{FASTCHG}$ ) until it reaches 3V. When the cell voltage is above 3V, fast charging occurs at the full set current. If the cell fails to reach the next prequalification threshold before a set time (see  $t_{PREQUAL1}$  and  $t_{PREQUAL2}$  in the *Timer Capacitor and Fault Modes* section), charging stops, a fault alarm is set, and the CHG output blinks.

Figures 2 and 3 show charging behavior typical Li+ cell. The MAX1925/MAX1926 remain in fast-charge mode until the battery voltage reaches regulation and the

charge current drops below 1/8th of  $I_{FASTCHG}$ . The charger then enters full toff mode and the CHG LED is turned off. In full toff mode, the controller continues to operate as in fast-charge mode, except that it remains in constant-voltage mode (CVM) unless the battery voltage falls. After every  $t_{PREQUAL1}$  (see the *Timer Capacitor and Fault Modes* section) where charge current is interrupted so that the battery voltage can be accurately measured.

The MAX1925/MAX1926 do not enter done mode until  $t_{FULLCHG}$  has been reached. If the battery is removed

# Switch-Mode 1-Cell Li+ Chargers

勝特力材料 886-3-5753170  
 勝特力电子(上海) 86-21-54151736  
 勝特力电子(深圳) 86-755-83298787  
[Http://www.100y.com.tw](http://www.100y.com.tw)

and a new battery is connected during either fast-charge or full toff modes, the charger begins with full charge current without prequalification unless the part is reset. Detect battery insertion by connecting THRM to a thermistor on the battery, if a thermistor is used, or to a 10kΩ resistor linked to a battery door mechanism.

## Constant-Current Mode (CCM)

When the battery voltage is below 4.2V, the MAX1925/MAX1926 regulate the charging current by controlling the peak and valley inductor currents. When the inductor current exceeds the  $158\text{mV}/R_{\text{SET}}$ , the MAX1925/MAX1926 turn the external PFET off. When the inductor current falls below  $128\text{mV}/R_{\text{SET}}$ , the MAX1925/MAX1926 turns the external PFET on, but only if the battery voltage is below regulation. The maximum cell charging current is programmed by selecting the external  $R_{\text{SET}}$  (see Figure 1) resistor connected between BATT and CS. Select the external resistor value using  $R_{\text{SET}} = 142\text{mV}/I_{\text{FASTCHG}}$ .

The accuracy of the charge current is a function of input voltage, battery voltage, inductance, and comparator delay (300ns typ). Determine the charge-current error according to the following equation:

$$\Delta I_{\text{CHG}} = \frac{(V_{\text{IN}} - 2 \times V_{\text{BATT}}) \times t_{\text{Delay}}}{2 \times L}$$

where  $\Delta I_{\text{CHG}}$  is the charge-current error, and  $t_{\text{Delay}}$  is the current-sense comparator delay.

For this reason choose L for an on-time and off-time greater than  $2 \times t_{\text{Delay}}$  to minimize error in the charging current.

## Constant-Voltage Mode (CVM)

In constant-voltage mode (CVM), the controller regulates the peak and valley of the output ripple. The maximum cell voltage is regulated to 4.2V. If, for any reason, the cell voltage exceeds 4.35V, a fault alarm is set, the  $\overline{\text{CHG}}$  output blinks, and the PFET power switch is held off. The charger can then be restarted only by cycling input power or the EN input.

## Indication of Charge Completion ( $\overline{\text{CHG}}$ )

The  $\overline{\text{CHG}}$  output is a 10mA current-sink output that indicates the cell's charging status. Connect an LED from IN to  $\overline{\text{CHG}}$  for a visible indicator. Alternatively, a pullup resistor (typically 200kΩ) from a logic supply to  $\overline{\text{CHG}}$  provides a logic-level output. Table 1 relates the status of the LED to the condition of the charger and battery.

## ACON Output

The  $\overline{\text{ACON}}$  open-drain output indicates when usable power is applied to IN. In the MAX1926 when  $V_{\text{IN}}$  exceeds  $\overline{\text{ACON}}$  threshold (nominally 4.25V with  $\overline{\text{IN}}$  rising—see the *Electrical Characteristics* table),  $\overline{\text{ACON}}$  goes low. In the MAX1925,  $\overline{\text{ACON}}$  goes low when the input voltage is between 4.5V and 6.1V (see Table 2).

## Re-Initiating a Charging Cycle

The MAX1925/MAX1926 feature automatic restart that resumes charging when the cell voltage drops to 4V and  $t_{\text{FULL\_CHG}}$  is completed. By automatically resuming charging

**Table 1.  $\overline{\text{CHG}}$  Output States**

STATE	CONDITION	$\overline{\text{CHG}}$
OFF	EN low or no battery or input power	High impedance (LED off)
PREQUAL1	Charge current = 4mA until BATT reaches 2V.	Low (LED on)
PREQUAL2	Charge current = C/10 until BATT reaches 3V.	Low (LED on)
FAST CHARGE	Charge current = C = $142\text{mV}/R_{\text{SET}}$ .	Low (LED on)
FULL CHARGE	Charge current has fallen to C/8.	High impedance (LED off)
FAULT PREQUAL1	BATT does not reach 2V before PREQUAL1 timeout.	Blinking. LED on 50% $f_{\text{BLINK}}$ (0.5Hz). Can only be cleared by cycling input power, THRM, or EN.
FAULT PREQUAL2	BATT does not reach 3V before PREQUAL2 timeout.	
FAULT FULL	Charge current does not drop to C/8 before FULL CHARGE timeout.	
FAULT BATT VOLTAGE	Battery voltage has exceeded 4.35V.	Blinking. LED on 50% $f_{\text{BLINK}}$ (0.5Hz).
FAULT TEMP	Temperature has risen above +50°C or fallen below 0°C. Temp fault clears by itself.	MAX1925—High impedance (LED off)
		MAX1926—Blinking (LED on 50% 0.5Hz)
NONE	Initial power-up or enable with battery not present.	Blinking at rapid rate as charger cycles through RESET, PREQUAL1, and DONE.

# Switch-Mode 1-Cell Li+ Chargers

MAX1925/MAX1926

**Table 2. ACON Behavior vs. VIN**

PART	VIN	ACON	CHARGING	CHG LED
MAX1925	VIN > VACON threshold (4.5V nom) and < 6.1V, and VIN > VBATT	LOW	YES	ON (until charge complete)
	VIN > VACON threshold and VIN < VBATT (Note: This state should never occur)	High Z	NO	OFF
	VIN < VACON threshold	High Z	NO	OFF
MAX1926	VIN > VACON threshold (4.25V nom) and VIN > VBATT	LOW	YES	ON (until charge complete)
	VIN > VACON threshold and VIN < VBATT (Note: This state should never occur)	High Z	NO	OFF
	VIN < VACON Threshold	High Z	NO	OFF

ing when the battery voltage drops, the MAX1925/MAX1926 ensure that the cell does not remain partially charged after use when charger power is available.

Charging also restarts if input power is cycled or if the charger is restarted by the EN or THRM input. If a new battery is inserted, the charger must be restarted. If the THRM functionality is used, the charger is automatically restarted upon battery insertion. When THRM is not used, toggle EN or connect THRM through a resistor to be grounded with a battery-door latch switch.

## Applications Information

### Timer Capacitor and Fault Modes

The on-chip timer checks charge progress and issues an alarm signal through a blinking CHG output when one of the safety timers times out (see Table 1). All timers are set by one external capacitor at CT. A 100nF value sets the full-charge timer (tFULLCHG) to 3 hours, the tPREQUAL1 timer to (tFULLCHG)/1088 (10s), and the tPREQUAL2 timer at (tFULLCHG)/17 (10.67 minutes).

If the charger enters full-charge state (after the charging current has fallen below C/8) before the full-charge timer expires, no fault occurs, but if the timer expires before full charge is reached, a fault is indicated (see Table 1).

A fault is also indicated if the battery voltage exceeds 4.35V. When the cell voltage exceeds 4.35V a fault alarm is set, the CHG output blinks, and the PFET turns off.

To restart the charger after a fault occurs, the fault state must be cleared by toggling EN, or by cycling input power at IN (see Figure 1). Temperature faults do not need to be cleared by EN. The MAX1925/MAX1926 resume charging after the temperature returns to within the set window.

### Inductor Selection

Because the MAX1925/MAX1926 is hysteretic, the constant-current mode switching frequency is a function of the inductance, sense resistance, and current-sense hysteresis (30mV, from the *Electrical Characteristics*). To minimize charge-current error:

$$L > \frac{(V_{IN} - 2 \times V_{BATT}) \times t_{Delay}}{2 \times \Delta I_{CHG}}$$

where  $\Delta I_{CHG}$  is the acceptable charge-current error and should usually be less than 1/4th the full charge current.  $t_{Delay}$  is the current-sense comparator delay (300ns typical). Calculate L for  $V_{IN} = V_{IN,MAX}$ ,  $V_{BATT} = V_{BATT,MIN}$ , with positive  $\Delta I_{CHG}$  and  $V_{IN} = V_{IN,MIN}$ ,  $V_{BATT} = V_{BATT,MAX}$ , with negative  $\Delta I_{CHG}$ . Use the larger calculated value for L.

The resulting switching frequency in CCM is:

$$f_{Switch} > \left( \frac{I_{HYST} \times L + t_{IDelay} V_{BATT}}{V_{IN} - V_{BATT}} + 2 \times t_{IDelay} + \frac{I_{HYST} \times L + t_{IDelay} \times (V_{IN} - V_{BATT})}{V_{BATT}} \right)^{-1}$$

Choose an inductor with an RMS and saturation current rating according to the following equation:

$$I_{SAT/RMS} > \frac{V_{IPK}}{R_{SET}} + \frac{(V_{IN} - V_{BATT}) t_{IDelay}}{L}$$

where  $V_{IPK}$  is the peak current-sense threshold (158mV typ).

### Output Capacitor Selection

The ESR of the output capacitor influences the switching frequency of the charger during voltage regulation

# Switch-Mode 1-Cell Li+ Chargers

mode. To ensure stable transition from CCM to CVM choose a capacitor with the following ESR:

$$R_{ESR} > \frac{V_{VHIST}}{V_{IHIST}} \times R_{SET}$$

where  $V_{VHIST}$  is the voltage hysteresis (15mV typ) and  $V_{IHIST}$  is the current-sense threshold hysteresis (typically 30mV). Tantalum capacitors are recommended. However a ceramic capacitor (typically 10μF) with a series resistor can also be used.

### MOSFET Selection

The MAX1925/MAX1926 drive an external P-channel MOSFET's gate from IN to GND. Choose a P-channel MOSFET with a  $|V_{DS,MAX}| > V_{IN}$ . Since EXT drives from rail to rail the MOSFET must also be rated for  $|V_{GS,MAX}| > V_{IN}$ . At the lower operating frequencies and currents for typical MAX1925/MAX1926 applications resistive and diode losses dominate switching losses. For this reason choose a MOSFET with a low  $R_{DS(on)}$ . The resistive losses are:

$$P_{Resistive\_losses} \cong D \times I_{CHG}^2 \times R_{DS(on)} + I_{CHG}^2 \times (R_{SET} + R_L)$$

where D is the operating duty cycle ( $V_{OUT}/V_{IN}$ ) and  $R_L$  is the inductor resistance. The MOSFET's power dissipation must exceed  $D \times I_{CHG}^2 \times R_{DS(on)}$ .

### Diode Selection

In the event of a short-circuited source, the body diode inherent in the external PFET allows the cell to discharge. To prevent this and to protect against negative input voltages, add a Schottky or silicon diode between the power source and IN.

The MAX1925/MAX1926 use a diode for catching the inductor current during the off cycle. Select a Schottky diode with a current rating greater than  $V_{IPK}/R_{SET}$  and a voltage rating greater than  $V_{IN}$ .

### Dropout Behavior

The MAX1925/MAX1926 regulate charging current by ramping inductor current between upper and lower thresholds, typically 128mV and 158mV across  $R_{SET}$ .

This results in an average current of  $142mV/R_{SET}$ . At input voltages near dropout (4.6V at IN for the typical circuit), the inductor current ramp waveform becomes somewhat flattened as inductor, MOSFET, input diode, and battery resistance limit inductor current. When the inductor current waveform flattens, its average value rises with respect to the upper and lower current thresholds. This creates a slight peak (about 5%) in charging current at high battery voltages as seen in the Charging Current vs. Battery Voltage plot in the *Typical Operating Characteristics*. Charging current is still controlled in dropout and the charger operates normally. The dropout current peak can be minimized by reducing MOSFET and inductor resistance, as well as forward voltage in the input diode.

### Thermistor Interface

An external thermistor inhibits charging by setting a fault flag when the cell is cold (<0°C) or hot (>+50°C). The THRM time-multiplexes two sense currents to test for both hot and cold qualification. Connect the thermistor between THRM and GND. If no temperature qualification is desired, replace the thermistor with a 10kΩ resistor connected through the battery-latch mechanism. The thermistor should be 10kΩ at +25°C and have a negative temperature coefficient, as defined by the expression below:

$$R_T = R_{25^\circ C} \times e^{\left\{ \beta \left[ \left( \frac{1}{T+273} \right) - \left( \frac{1}{298} \right) \right] \right\}}$$

Table 3 shows nominal fault detection temperatures that result from a wide range of available thermistor temperature curves.

For a given thermistor characteristic, it is possible to adjust the fault-detection temperatures by adding a resistor in series with the thermistor or a parallel resistor from THRM to GND.

### Chip Information

TRANSISTOR COUNT: 5722  
 PROCESS: BiCMOS

**Table 3. Fault Temperature for Different Thermistors**

THERMISTOR BETA	3000	3250	3500	3750
Resistance at +25°C	10000Ω	10000Ω	10000Ω	10000Ω
Resistance at +50°C	4587.78Ω	4299.35Ω	4029.06Ω	3775.75Ω
Resistance at 0°C	25140.55Ω	27148.09Ω	29315.94Ω	31656.90Ω
Nominal Hot Trip Temperature	55.14°C	52.60°C	50.46°C	48.63°C
Nominal Cold Trip Temperature	-3.24°C	-1.26°C	0.46°C	1.97°C

# Switch-Mode 1-Cell Li+ Chargers

## Package Information

(The package drawing(s) in this data sheet may not reflect the most current specifications. For the latest package outline information, go to [www.maxim-ic.com/packages](http://www.maxim-ic.com/packages).)

MAX1925/MAX1926

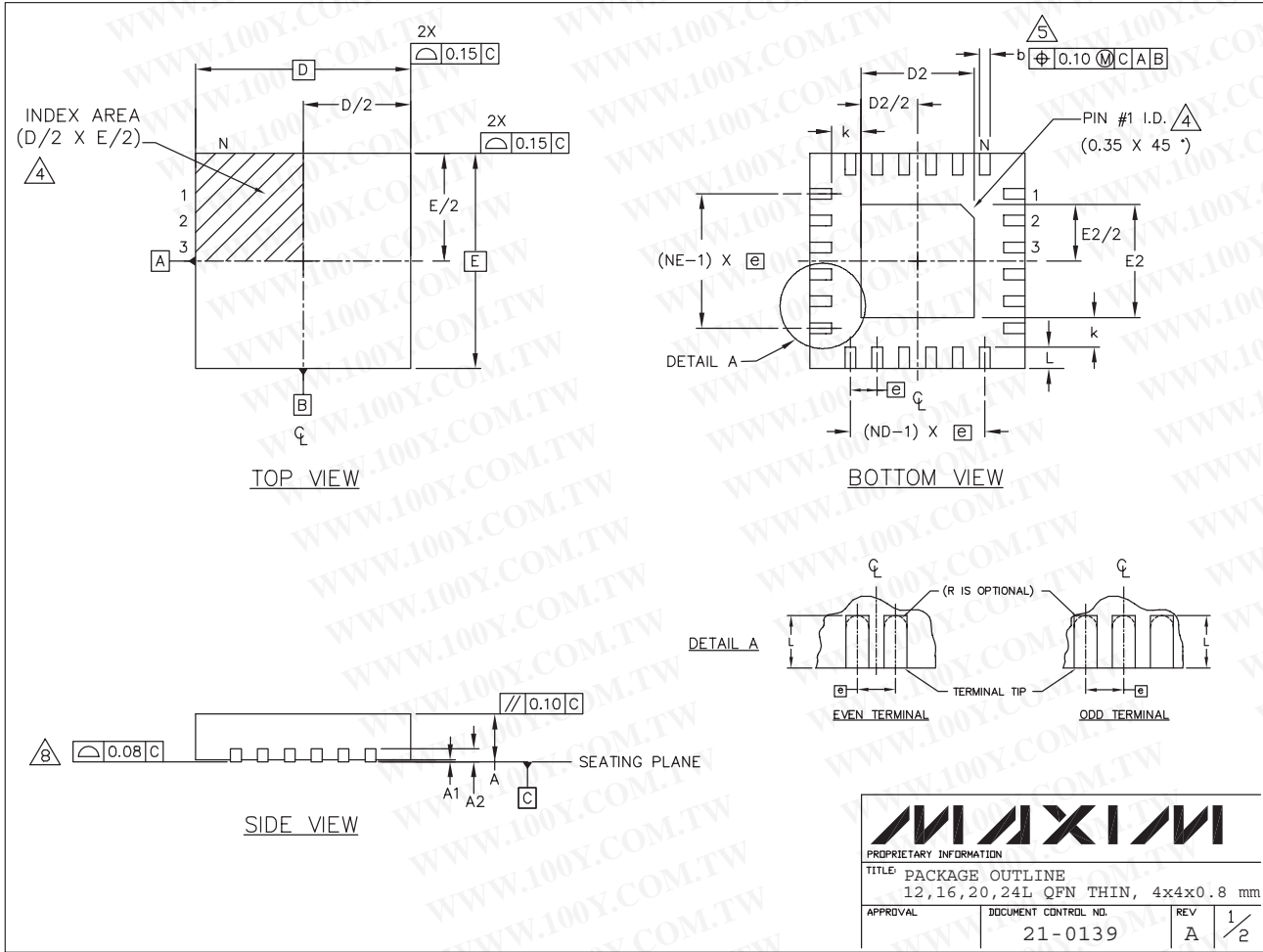

**勝特力材料 886-3-5753170**  
**勝特力电子(上海) 86-21-54151736**  
**勝特力电子(深圳) 86-755-83298787**  
[Http://www.100y.com.tw](http://www.100y.com.tw)

# Switch-Mode 1-Cell Li+ Chargers

## Package Information (continued)

(The package drawing(s) in this data sheet may not reflect the most current specifications. For the latest package outline information, go to [www.maxim-ic.com/packages](http://www.maxim-ic.com/packages).)

COMMON DIMENSIONS													EXPOSED PAD VARIATIONS							
PKG	12L 4x4			16L 4x4			20L 4x4			24L 4x4			PKG. CODES	D2			E2			
REF.	MIN.	NDM.	MAX.	MIN.	NDM.	MAX.	MIN.	NDM.	MAX.	MIN.	NDM.	MAX.		MIN.	NDM.	MAX.	MIN.	NDM.	MAX.	
A	0.70	0.75	0.80	0.70	0.75	0.80	0.70	0.75	0.80	0.70	0.75	0.80	T1244-2	1.95	2.10	2.25	1.95	2.10	2.25	
A1	0.0	0.02	0.05	0.0	0.02	0.05	0.0	0.02	0.05	0.0	0.02	0.05	T1644-2	1.95	2.10	2.25	1.95	2.10	2.25	
A2	0.20 REF			0.20 REF			0.20 REF			0.20 REF			T2044-1	1.95	2.10	2.25	1.95	2.10	2.25	
b	0.25	0.30	0.35	0.25	0.30	0.35	0.20	0.25	0.30	0.18	0.23	0.30	T2444-1	2.45	2.60	2.63	2.45	2.60	2.63	
D	3.90	4.00	4.10	3.90	4.00	4.10	3.90	4.00	4.10	3.90	4.00	4.10								
E	3.90	4.00	4.10	3.90	4.00	4.10	3.90	4.00	4.10	3.90	4.00	4.10								
e	0.80 BSC.			0.65 BSC.			0.50 BSC.			0.50 BSC.										
k	0.25	-	-	0.25	-	-	0.25	-	-	0.25	-	-								
L	0.45	0.55	0.65	0.45	0.55	0.65	0.45	0.55	0.65	0.30	0.40	0.50								
N	12			16			20			24										
ND	3			4			5			6										
NE	3			4			5			6										
JeDEC Vgr.	WGGB			WGGC			WGGD-1			WGGD-2										

NOTES:

- DIMENSIONING & TOLERANCING CONFORM TO ASME Y14.5M-1994.
- ALL DIMENSIONS ARE IN MILLIMETERS. ANGLES ARE IN DEGREES.
- N IS THE TOTAL NUMBER OF TERMINALS.
- THE TERMINAL #1 IDENTIFIER AND TERMINAL NUMBERING CONVENTION SHALL CONFORM TO JEDEC 95-1 SPP-012. DETAILS OF TERMINAL #1 IDENTIFIER ARE OPTIONAL, BUT MUST BE LOCATED WITHIN THE ZONE INDICATED. THE TERMINAL #1 IDENTIFIER MAY BE EITHER A MOLD OR MARKED FEATURE.
- DIMENSION b APPLIES TO METALLIZED TERMINAL AND IS MEASURED BETWEEN 0.25 mm AND 0.30 mm FROM TERMINAL TIP.
- ND AND NE REFER TO THE NUMBER OF TERMINALS ON EACH D AND E SIDE RESPECTIVELY.
- DEPOPULATION IS POSSIBLE IN A SYMMETRICAL FASHION.
- COPLANARITY APPLIES TO THE EXPOSED HEAT SINK SLUG AS WELL AS THE TERMINALS.
- DRAWING CONFORMS TO JEDEC MO220.

<b>MAXIM</b>			
PROPRIETARY INFORMATION			
TITLE: PACKAGE OUTLINE			
12, 16, 20, 24L QFN THIN, 4x4x0.8 mm			
APPROVAL	DOCUMENT CONTROL NO.	REV	2/2
	21-0139	A	

Maxim cannot assume responsibility for use of any circuitry other than circuitry entirely embodied in a Maxim product. No circuit patent licenses are implied. Maxim reserves the right to change the circuitry and specifications without notice at any time.

16 **Maxim Integrated Products, 120 San Gabriel Drive, Sunnyvale, CA 94086 408-737-7600**