



Single-Channel CardBus and PCMCIA VCC/VPP Power-Switching Network

General Description

The MAX1602 DC power-switching IC contains a network of low-resistance MOSFET switches that deliver selectable VCC and VPP voltages to a single CardBus or PC Card host socket. Key features include low-resistance switches, small packaging, soft-switching action, and compliance with PCMCIA specifications for 3V/5V switching. 3.3V-only power switching for fast, 32-bit CardBus applications is supported in two ways: low-resistance 3.3V switches allow high 3.3V load currents (up to 1A); and completely independent internal charge pumps let the 3.3V switch operate normally, even if the +5V and +12V supplies are disconnected or turned off to conserve power. The internal charge pumps are regulating types that draw reduced input current when the VCC switches are static. Power consumption is automatically reduced to 11 μ A max when the outputs are high-Z or GND.

Other key features include guaranteed specifications for output current limit level, and guaranteed specifications for output rise/fall times (in compliance with PCMCIA specifications). Reliability is enhanced by thermal-overload protection, accurate current limiting, an overcurrent-fault flag output, and undervoltage lock-outs. The CMOS/TTL-logic interface is flexible, and can tolerate logic input levels in excess of the positive supply rail.

The MAX1602 fits a complete CardBus/PCMCIA switch into a space-saving, 16-pin QSOP package.

Applications

Data Loggers
 Handy-Terminals
 Docking Stations
 PCMCIA Read/Write Drives

Ordering Information

PART	TEMP. RANGE	PIN-PACKAGE
MAX1602EEE	-40°C to +85°C	16 QSOP

Pin Configuration appears on last page.

Features

- ◆ Supports a Single PC Card/CardBus Socket
- ◆ 1A, 0.25 Ω Max 3.3V VCC Switch
- ◆ 1A, 0.25 Ω Max 5V VCC Switch
- ◆ Soft Switching for Low Inrush Surge Current
- ◆ Overcurrent Protection
- ◆ Overcurrent/Thermal-Fault Flag Output
- ◆ Thermal Shutdown at T_j = +150°C
- ◆ Independent Internal Charge Pumps
- ◆ Break-Before-Make Switching Action
- ◆ 11 μ A Max Standby Supply Current
- ◆ 5V and 12V Not Required for Low-RDS(ON) 3.3V Switching
- ◆ Complies with PCMCIA 3V/5V Switching Specifications
- ◆ Super-Small 16-Pin QSOP Package
- ◆ Code Compatible with:
 - ◆ Cirrus CL-PD67XX Family Databook DB86184
 - ◆ Intel 82365SL (industry-standard coding)

MAX1602

Simplified Block Diagram

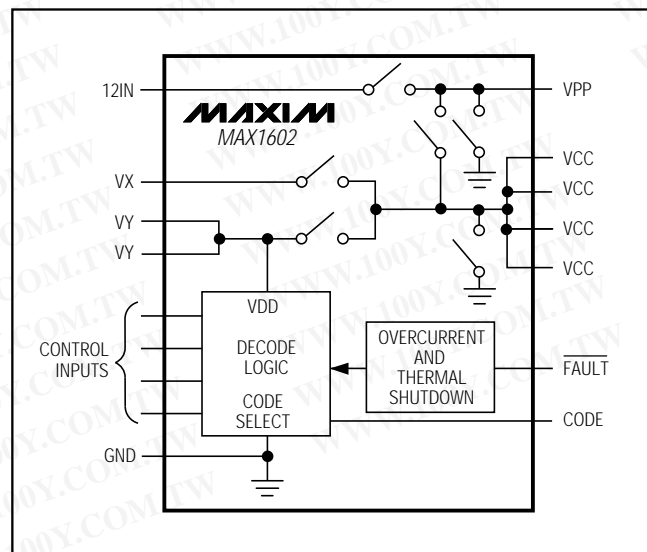

Single-Channel CardBus and PCMCIA VCC/VPP Power-Switching Network

ABSOLUTE MAXIMUM RATINGS

Inputs/Outputs to GND (VX, VY, VCC) (Note 1)	-0.3V, +6V	VCC Short Circuit to GND	Continuous
VPP Input/Output to GND (12IN, VPP) (Note 1)	-0.3V, +15V	VPP Short Circuit to GND	Continuous
Logic Inputs to GND (A0VCC, A1VCC, A0VPP, A1VPP) (Note 1)	-0.3V, +6V	Continuous Power Dissipation (T _A = +70°C) QSOP (derate 8.3mW/°C above +70°C)	667mW
CODE Input to GND	-0.3V, (VY + 0.3V)	Operating Temperature Range MAX1602EEE	-40°C to +85°C
VCC Output Current (Note 2)	4A	Storage Temperature Range	-65°C to +160°C
VPP Output Current (Note 2)	260mA	Lead Temperature (soldering, 10sec)	+300°C

Note 1: There are no parasitic diodes between any of these pins, so there are no power-up sequencing restrictions (for example, logic input signals can be applied even if all of the supply voltage inputs are grounded).

Note 2: VCC and VPP outputs are internally current limited. See the *Electrical Characteristics*.

Stresses beyond those listed under "Absolute Maximum Ratings" may cause permanent damage to the device. These are stress ratings only, and functional operation of the device at these or any other conditions beyond those indicated in the operational sections of the specifications is not implied. Exposure to absolute maximum rating conditions for extended periods may affect device reliability.

ELECTRICAL CHARACTERISTICS

(VY = 3.3V, VX = 5V, 12IN = 12V, T_A = 0°C to +85°C, unless otherwise noted. Typical values are at T_A = +25°C.)

PARAMETER	CONDITIONS	MIN	TYP	MAX	UNITS
POWER-SUPPLY SECTION					
Input Voltage Range	VX, VY	3.0		5.5	V
	12IN	11		13	
Undervoltage Lockout Threshold	VY falling edge	2.4	2.6	2.8	V
	12IN falling edge	1.8	3.0		
	12IN rising edge	5.0	8.0	10.0	
	VX falling edge	1.4	1.9	2.8	
VY Standby Supply Current	All switches 0V or high-Z, control inputs = 0V or VY, T _A = +25°C		3	11	μA
VX Standby Supply Current	VX all switches 0V or high-Z, control inputs = 0V or VY, T _A = +25°C			1	μA
12IN Standby Supply Current	All switches 0V or high-Z, control inputs = 0V or VY, T _A = +25°C			1	μA
VY Quiescent Supply Current	Any combination of VY switches on, control inputs = 0V or VY, no VCC loads		20	200	μA
VX Quiescent Supply Current	Control inputs = 0V or VY, no VCC loads		10	50	μA
12IN Quiescent Supply Current	VPP 12V switches on, control inputs = 0V or VY, no VPP loads		5	100	μA
VCC SWITCHES					
Operating Output Current Range	VCC, VX = VY = 3V to 5.5V	0		1	A
On-Resistance, VY Switches	12IN = 0V to 13V, VY = 3V, VX = 0V to 5.5V, I _{SWITCH} = 1A, T _A = +25°C		0.09	0.25	Ω
On-Resistance, VX Switches	12IN = 0V to 13V, VX = 4.5V, VY = 0V to 5.5V, I _{SWITCH} = 1A, T _A = +25°C		0.09	0.25	Ω
Output Current Limit	VCC	1.2		4	A

Single-Channel CardBus and PCMCIA VCC/VPP Power-Switching Network

MAX1602

ELECTRICAL CHARACTERISTICS (continued)

(VY = 3.3V, VX = 5V, 12IN = 12V, TA = 0°C to +85°C, unless otherwise noted. Typical values are at TA = +25°C.)

PARAMETER	CONDITIONS	MIN	TYP	MAX	UNITS
Output Sink Current	VCC < 0.4V, programmed to 0V state	10			mA
Output Leakage Current	VCC forced to 0V, high-Z state, TA = +25°C		1	10	μA
Output Propagation Delay Plus Rise Time	VCC, 0V to VX or VY, CL = 30μF, RL = 25Ω, 50% of input to 90% of output, TA = +25°C		2	10	ms
Output Rise Time	VCC, 0V to VX or VY, CL = 1μF, RL = open circuit, 10% to 90% points, TA = +25°C	100	1200		μs
Output Propagation Delay Plus Fall Time	VCC, VX or VY to 0V, CL = 30μF, RL = open circuit, 50% of input to 10% of output, TA = +25°C		90	150	ms
Output Fall Time	VCC, VX or VY to 0V, CL = 1μF, RL = 25Ω, 90% to 10% points		6		ms
VPP SWITCHES					
Operating Output Current Range	VPP	0		120	mA
On-Resistance, 12V Switches	12IN = 11.6V, ISWITCH = 100mA, TA = +25°C		0.70	1	Ω
On-Resistance, VPP = VCC Switches	Programmed to VX (5V) or VY (3.3V), TA = +25°C		3	6	Ω
Output Current Limit	VPP programmed to 12V	130	200	260	mA
Output Sink Current	VPP < 0.4V, programmed to 0V state	10			mA
Output Leakage Current	VPP forced to 0V, high-Z state, TA = +25°C		0.1	10	μA
Output Propagation Delay Plus Rise Time	VPP, 0V to 12IN, CL = 0.1μF, 50% of input to 90% of output, TA = +25°C		1.2	30	ms
Output Rise Time	VPP, 0V to 12IN, CL = 0.1μF, 10% to 90% points, TA = +25°C	100	600		μs
Output Propagation Delay Plus Fall Time	VPP, 12IN to 0V, CL = 0.1μF, 50% of input to 10% of output, TA = +25°C		9	60	ms
Output Fall Time	VPP, 12IN to 0V, CL = 0.1μF, RL = 100Ω, 90% to 10% points		6		ms
INTERFACE AND LOGIC SECTION					
FAULT Signal Propagation Delay	VCC or VPP, load step to FAULT output, 50% point to 50% point (Note 3)		1		μs
FAULT Output Low Voltage	ISINK = 1mA, low state			0.4	V
FAULT Output Leakage Current	VFAULT = 5.5V, high state	-0.5		0.5	μA
Thermal Shutdown Threshold	Hysteresis = 20°C (Note 4)		150		°C
Logic Input Low Voltage	__VCC, __VPP			0.6	V
Logic Input High Voltage	__VCC, __VPP	1.5			V
Code Input Low Voltage	"Intel" code	0		0.4	V
Code Input High Voltage	"Cirrus" code	VY - 0.4		VY	V
Code Input Mid-Level Voltage	"Databook" code	1.2		VY - 1.2	V
Logic Input Bias Current	__VCC, __VPP, code	-1		1	μA

Single-Channel CardBus and PCMCIA VCC/VPP Power-Switching Network

ELECTRICAL CHARACTERISTICS

(VY = 3.3V, VX = 5V, 12IN = 12V, T_A = -40°C to +85°C, unless otherwise noted.)

PARAMETER	CONDITIONS	MIN	TYP	MAX	UNITS
POWER-SUPPLY SECTION					
Input Voltage Range	VX, VY	3.0		5.5	V
	12IN	11		13	
Undervoltage Lockout Threshold	VY falling edge, hysteresis = 1%	2.3		2.9	V
	12IN falling edge	1.8			
	12IN rising edge	5		10	
	VX, VY falling edge	1.4		2.9	
VY Standby Supply Current	All switches 0V or high-Z, control inputs = 0V or VY			30	μA
VX Standby Supply Current	VX, all switches 0V or high-Z, control inputs = 0V or VY, T _A = T _{MIN} to T _{MAX}			15	μA
12IN Standby Supply Current	All switches 0V or high-Z, control inputs = 0V or VY			15	μA
VY Quiescent Supply Current	Any combination of VY switches on, control inputs = 0V or VY, no VCC loads			200	μA
VX Quiescent Supply Current	Any combination of VX switches on, control inputs = 0V or high-Z, no VCC loads			50	μA
12IN Quiescent Supply Current	12V switches on, control inputs = 0V or VY, no VPP loads			100	μA
FAULT Output Low Voltage	I _{SINK} = 1mA, low state			0.4	V
Logic Input Low Voltage	__VCC, __VPP			0.6	V
Logic Input High Voltage	__VCC, __VPP	1.6			V

Note 3: Not production tested.

Note 4: Thermal limit not active in standby state (all switches programmed to GND or high-Z state).

勝特力材料 886-3-5753170
 勝特力电子(上海) 86-21-54151736
 勝特力电子(深圳) 86-755-83298787
[Http://www.100y.com.tw](http://www.100y.com.tw)

Single-Channel CardBus and PCMCIA VCC/VPP Power-Switching Network

Typical Operating Characteristics

(VY = 3.3V, VX = 5V, 12IN = 12V, TA = +25°C, unless otherwise noted.)

MAX1602

VCC SWITCHING (RISE)

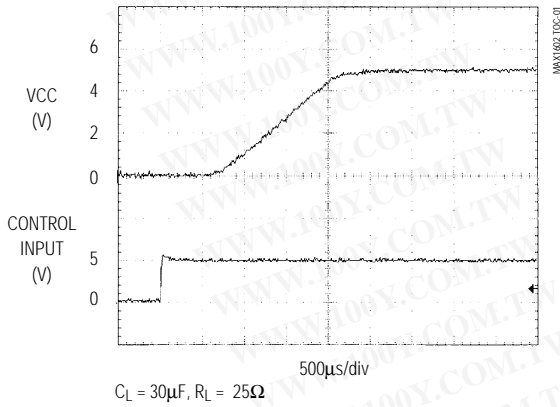

VCC SWITCHING (RISE)

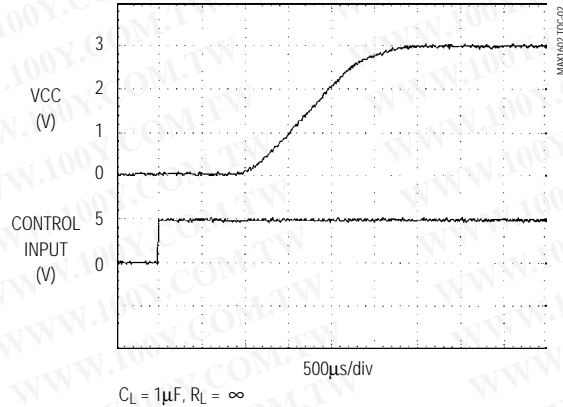

VCC SWITCHING (FALL)

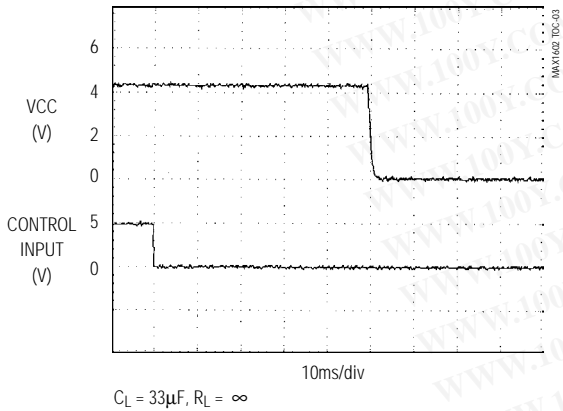

VCC SWITCHING (FALL)

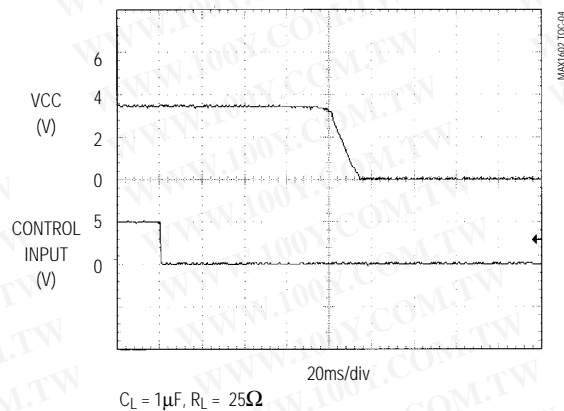

VPP SWITCHING (RISE)

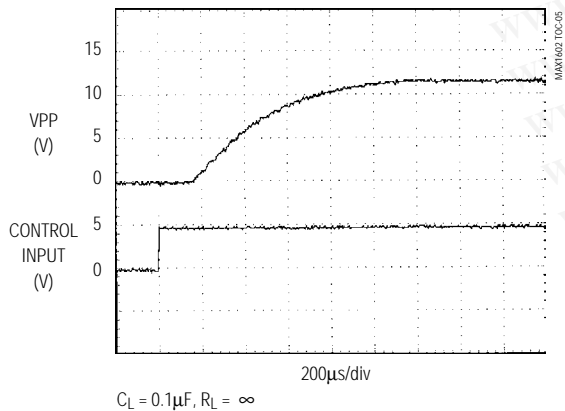

VPP SWITCHING (FALL)

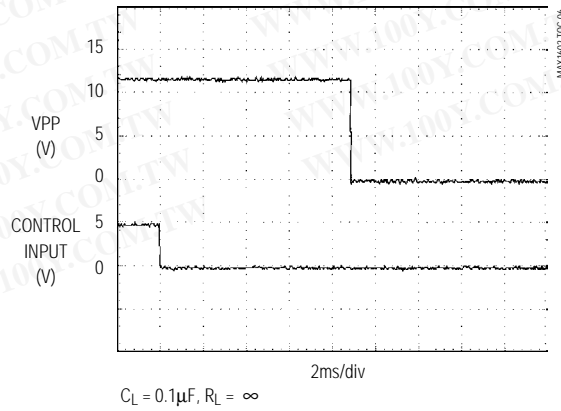

Single-Channel CardBus and PCMCIA VCC/VPP Power-Switching Network

Typical Operating Characteristics (continued)

(VY = 3.3V, VX = 5V, I2IN = 12V, TA = +25°C, unless otherwise noted.)

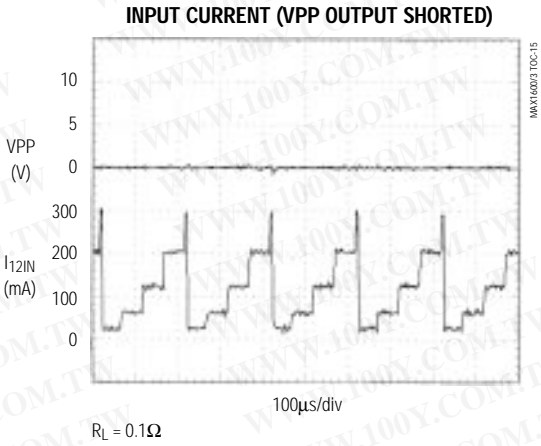
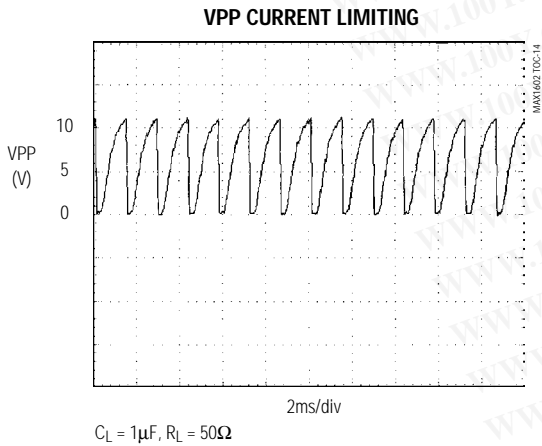
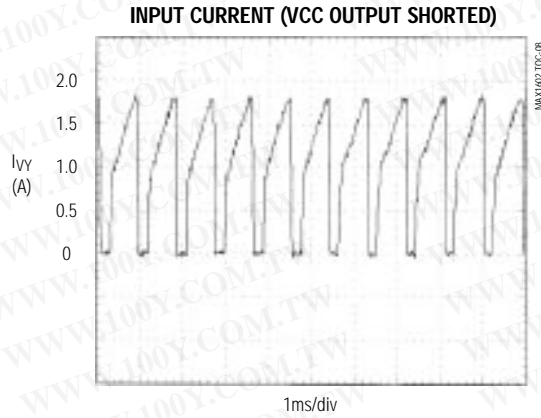
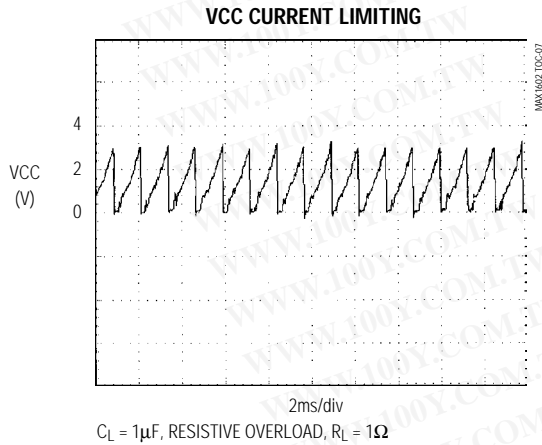

勝特力材料 886-3-5753170
 勝特力电子(上海) 86-21-54151736
 勝特力电子(深圳) 86-755-83298787
[Http://www.100y.com.tw](http://www.100y.com.tw)

Single-Channel CardBus and PCMCIA VCC/VPP Power-Switching Network

MAX1602

Typical Operating Characteristics (continued)

(VY = 3.3V, VX = 5V, 12IN = 12V, TA = +25°C, unless otherwise noted.)

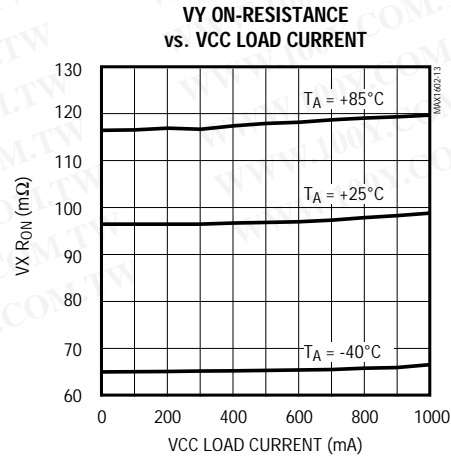
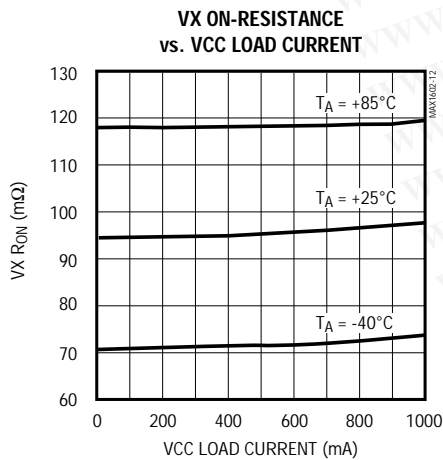
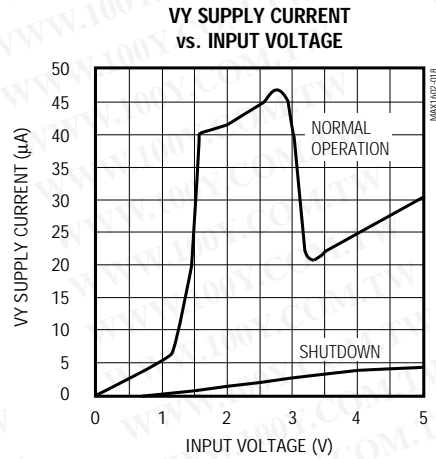
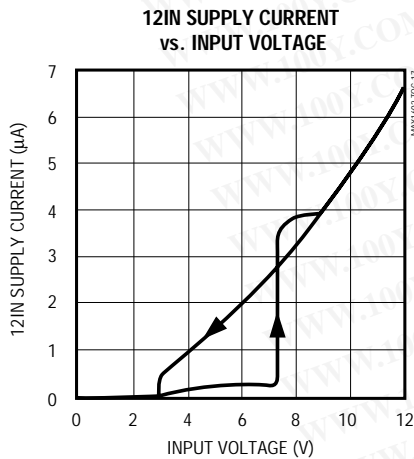
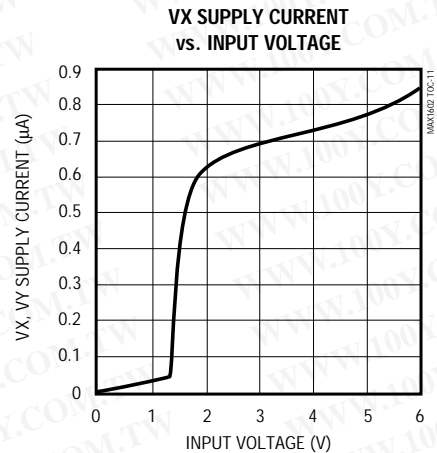
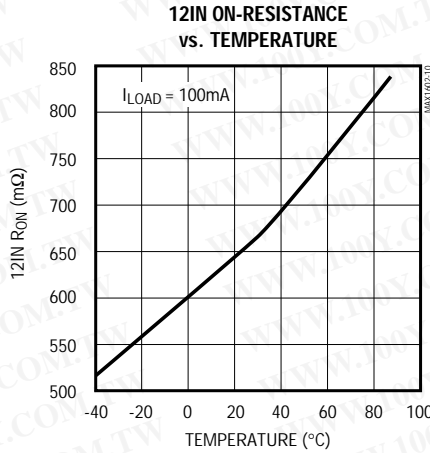
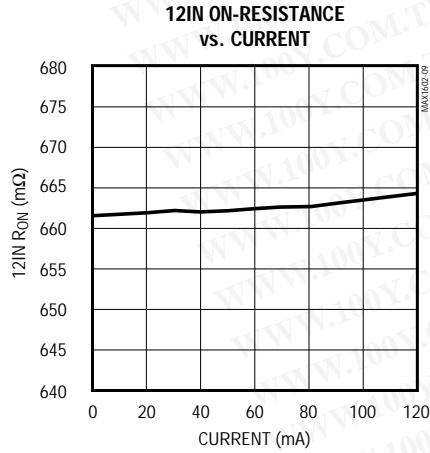

Single-Channel CardBus and PCMCIA VCC/VPP Power-Switching Network

MAX1602

Pin Description

PIN	NAME	FUNCTION
1	GND	Ground
2	12IN	+12V Supply Voltage Input
3	VPP	VPP Output
4, 6, 7, 9	VCC	VCC Output. Connect all four VCC pins together.
5	VX	VX Supply Voltage Input. Input range is +3.0V to +5.5V. VX is normally connected to 5V.
8, 10	VY	VY and Logic Supply Voltage Inputs. VY pins must be connected together. Input range is +3V to +5.5V. VY is normally connected to 3.3V.
11	A0VPP	VPP Control Input (see Logic Truth Tables).
12	A1VPP	VPP Control Input (see Logic Truth Tables).
13	A0VCC	VCC Control Input (see Logic Truth Tables).
14	A1VCC	VCC Control Input (see Logic Truth Tables).
15	CODE	Three-Level Code-Select Input (see Logic Truth Tables): Low = Standard "Intel" code, High = "Cirrus" code, Mid-Supply = "Databook" code (Figure 4).
16	FAULT	Fault-Detection Output. FAULT goes low during current limit, undervoltage lockout, or thermal limit. FAULT is an open-drain output that requires an external pull-up resistor.

Logic Truth Tables

Table 1. Standard "Intel" Code (82365SL), CODE = GND

A1VCC	A0VCC	A1VPP	A0VPP	VCC	VPP	MODE
0	0	0	0	GND	GND	STBY
0	0	0	1	GND	GND	STBY
0	0	1	0	GND	GND	STBY
0	0	1	1	GND	GND	STBY
0	1	0	0	VY	GND	Active
0	1	0	1	VY	VCC	Active
0	1	1	0	VY	12IN	Active
0	1	1	1	VY	High-Z	Active
1	0	0	0	VX	GND	Active
1	0	0	1	VX	VCC	Active
1	0	1	0	VX	12IN	Active
1	0	1	1	VX	High-Z	Active
1	1	0	0	VY	GND	Active
1	1	0	1	VY	VCC	Active
1	1	1	0	VY	12IN	Active
1	1	1	1	VY	High-Z	Active

STBY = Standby Mode

Table 2. "Cirrus" Code, CODE = High (VY)

A1VCC	A0VCC	A1VPP	A0VPP	VCC	VPP	MODE
0	0	0	0	High-Z	High-Z	STBY
0	0	0	1	High-Z	High-Z	STBY
0	0	1	0	High-Z	High-Z	STBY
0	0	1	1	High-Z	High-Z	STBY
0	1	0	0	VX	GND	Active
0	1	0	1	VX	VCC	Active
0	1	1	0	VX	12IN	Active
0	1	1	1	VX	High-Z	Active
1	0	0	0	VY	GND	Active
1	0	0	1	VY	VCC	Active
1	0	1	0	VY	12IN	Active
1	0	1	1	VY	High-Z	Active
1	1	0	0	GND	GND	STBY
1	1	0	1	GND	GND	STBY
1	1	1	0	GND	GND	STBY
1	1	1	1	GND	GND	STBY

STBY = Standby Mode

Single-Channel CardBus and PCMCIA VCC/VPP Power-Switching Network

Logic Truth Tables (cont.)

Table 3. "Databook" Code, CODE = Mid-Supply (VY/2)

A1VCC	A0VCC	AVPP	A0VPP	VCC	VPP	MODE
0	0	0	X	GND	High-Z	STBY
0	0	1	X	VY	12IN	Active
0	1	0	X	GND	GND	STBY
0	1	1	X	VX	12IN	Active
1	0	0	X	VY	VCC	Active
1	0	1	X	VY	GND	Active
1	1	0	X	VX	VCC	Active
1	1	1	X	VX	GND	Active

STBY = Standby Mode, X = Don't Care

Detailed Description

The MAX1602 power-switching IC contains a network of low-resistance MOSFET switches that deliver selectable VCC and VPP voltages to two CardBus or PC Card host socket. Figure 1 is the detailed block diagram.

The power-input pins (VY, VX, 12IN) are completely independent, however, power must always be applied to VY for proper operation. Low inrush current is guaranteed by controlled switch rise times. VCC's 100 μ s minimum output rise time is 100% tested with a 1 μ F capacitive load, and VPP's 1ms minimum rise time is guaranteed with a 0.1 μ F load. These respective capacitive loads are chosen as worst-case card-insertion parameters. The internal switching control allows VCC and VPP rise times to be controlled, and makes them nearly

MAX1602

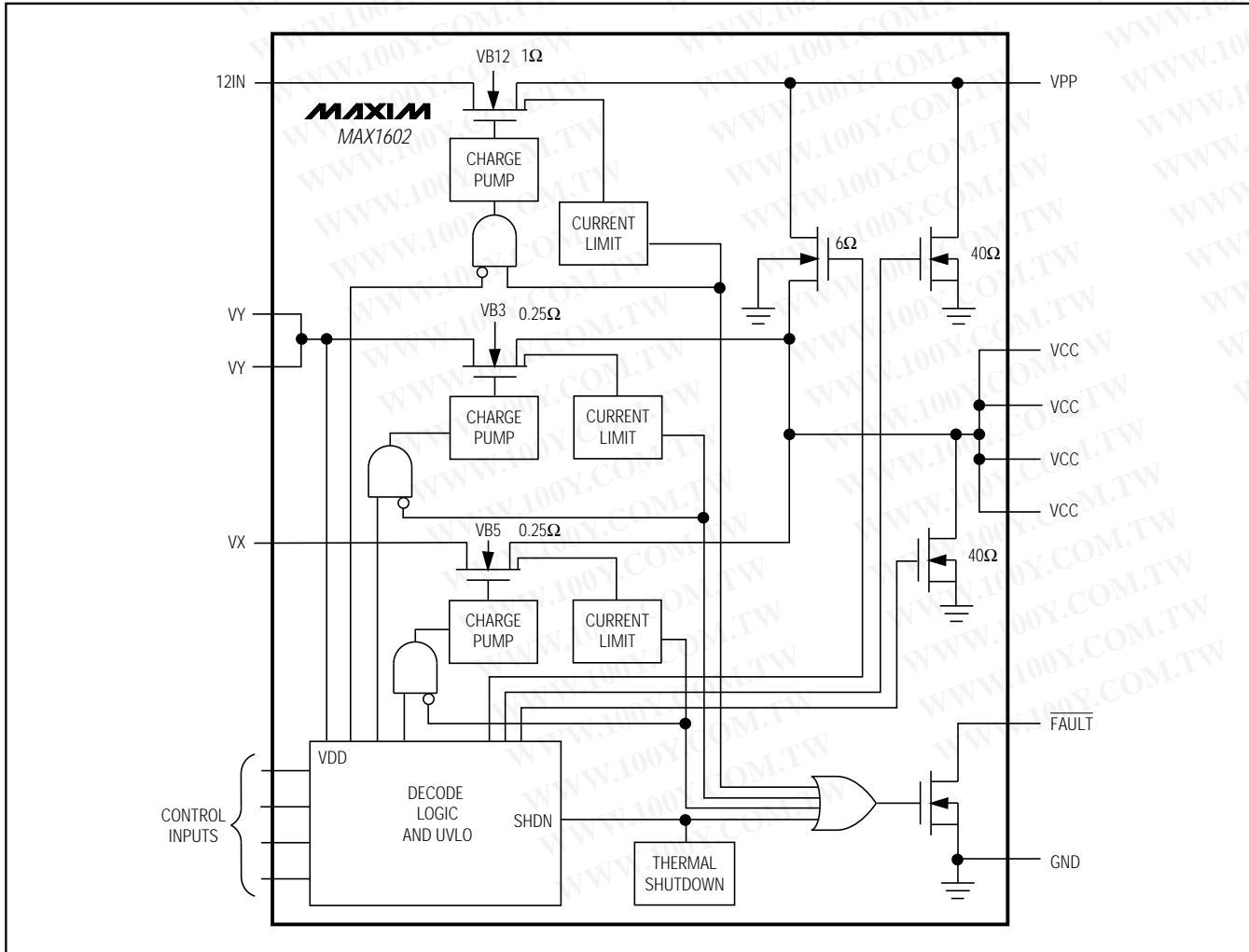

Figure 1. Detailed Block Diagram

Single-Channel CardBus and PCMCIA VCC/VPP Power-Switching Network

independent of resistive and capacitive loads (see rise-time photos in the *Typical Operating Characteristics*). Fall times are a function of loading, and are compensated by internal circuitry.

Power savings is automatic: internal charge pumps draw very low current when the VCC switches are static. Standby mode reduces switch supply current to 11µA.

Operating Modes

The MAX1602 is compatible with the Cirrus CL-PD67XX, Databook DB86184, and Intel 82365SL PC Card Interface Controllers (PCIC). Four control inputs select the internal switches' positions and the operating modes according to the input code. Select the proper code format for the chosen controller with the CODE input pin (see *Pin Description* and Tables 1, 2, and 3). CODE reconfigures the logic decoder to one of three interface controllers:

Low = Standard "Intel" code (Figure 3)

High = "Cirrus" code (Figure 2)

Mid-supply = "Databook" code (Figure 4)

An additional 1µA (3µA max) of VY supply current will flow if CODE = mid-supply (VY/2).

The MAX1602 has two operating modes: normal and standby. Normal mode supplies the selected outputs with their appropriate supply voltages. Standby mode places all switches at ground, high impedance, or a combination of the two.

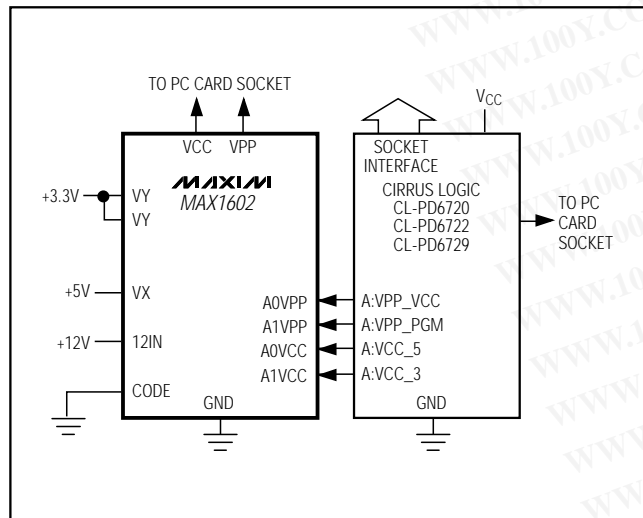

Figure 2. Application with Cirrus Logic Interface

Overcurrent Protection

Peak detecting circuitry protects both the VCC and VPP switches against overcurrent conditions. When current through any switch exceeds the internal current limit (4A for VCC switches and 200mA for VPP switches) the switch turns off briefly, then turns on again at the controlled rise rate. If the overcurrent condition lasts more than 2µs, the FAULT output goes low. FAULT is not latched. A continuous short-circuit condition results in a pulsed output current and a pulsed FAULT output until thermal shutdown is reached. FAULT is open-drain and requires an external pull-up resistor.

Thermal Shutdown

If the IC junction temperature rises above +150°C, the thermal shutdown circuitry opens all switches, including the GND switches, and FAULT is pulled low. When the temperature falls below +130°C, the switches turn on again at the controlled rise rate. If the overcurrent condition remains, the part cycles between thermal shutdown and overcurrent.

Undervoltage Lockout

If the VX switch input voltage drops below 1.9V, the associated switch turns off and FAULT goes low. For example, if VY is 3.3V and VX is 0V, and if the interface controller selects VY, the VCC output will be 3.3V. If VX is selected, VCC changes to a high-impedance output and FAULT goes low.

When a voltage is initially applied to 12IN, it must be greater than 8V to allow the switch to operate. Operation continues until the voltage falls below 2V (the VPP output is high impedance).

When VY drops to less than 2.6V, all switches are turned off and the VCC and VPP outputs are high impedance.

Applications Information

Supply Bypassing

Bypass the VY, VX, and 12IN inputs with ceramic 0.1µF capacitors. Bypass the VCC and VPP outputs with a 0.1µF capacitor for noise reduction and ESD protection.

Single-Channel CardBus and PCMCIA VCC/VPP Power-Switching Network

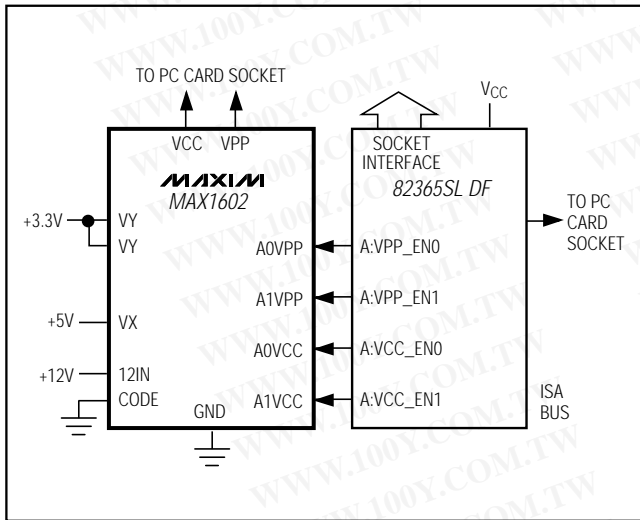

Figure 3. Application with Intel Interface

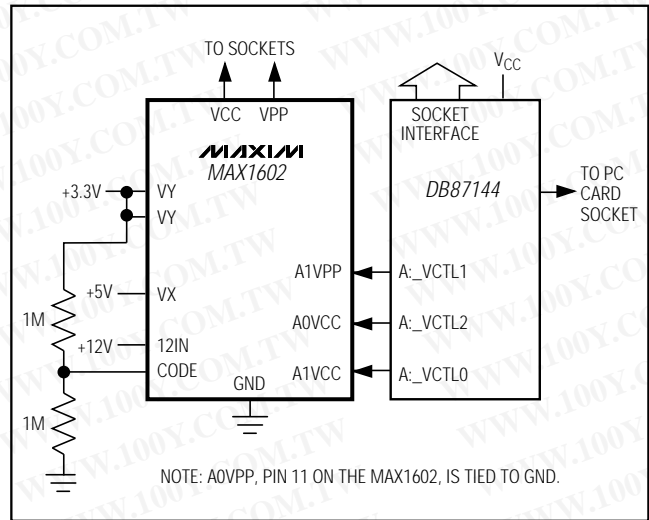

Figure 4. Block Diagram of the Databook DB87144 PCI to CardBus Controller Interface to the MAX1602

MAX1602

勝特力材料 886-3-5753170
 勝特力电子(上海) 86-21-54151736
 勝特力电子(深圳) 86-755-83298787
[Http://www.100y.com.tw](http://www.100y.com.tw)

Single-Channel CardBus and PCMCIA VCC/VPP Power-Switching Network

Pin Configuration

Chip Information

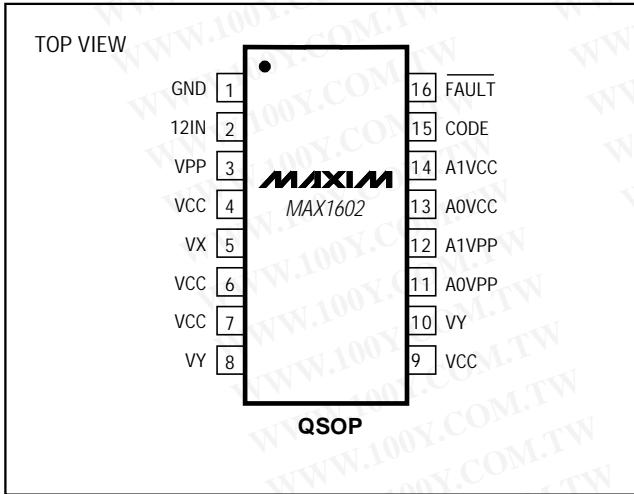

TRANSISTOR COUNT: 1452

勝特力材料 886-3-5753170
 勝特力电子(上海) 86-21-54151736
 勝特力电子(深圳) 86-755-83298787
[Http://www.100y.com.tw](http://www.100y.com.tw)

Package Information

DIM	INCHES		MILLIMETERS	
	MIN	MAX	MIN	MAX
A	0.061	0.068	1.55	1.73
A1	0.004	0.0098	0.127	0.25
A2	0.055	0.061	1.40	1.55
B	0.008	0.012	0.20	0.31
C	0.0075	0.0098	0.19	0.25
D	SEE VARIATIONS			
E	0.150	0.157	3.81	3.99
e	0.25 BSC		0.635 BSC	
H	0.230	0.244	5.84	6.20
h	0.010	0.016	0.25	0.41
L	0.016	0.035	0.41	0.89
N	SEE VARIATIONS			
S	SEE VARIATIONS			
α	0°	8°	0°	8°

DIM	PINS	INCHES		MILLIMETERS	
		MIN	MAX	MIN	MAX
D	16	0.189	0.196	4.80	4.98
S	16	0.0020	0.0070	0.05	0.18
D	20	0.337	0.344	8.56	8.74
S	20	0.0500	0.0550	1.27	1.40
D	24	0.337	0.344	8.56	8.74
S	24	0.0250	0.0300	0.64	0.76
D	28	0.386	0.393	9.80	9.98
S	28	0.0250	0.0300	0.64	0.76

21-0055A

**QSOP
QUARTER
SMALL-OUTLINE
PACKAGE**

Maxim cannot assume responsibility for use of any circuitry other than circuitry entirely embodied in a Maxim product. No circuit patent licenses are implied. Maxim reserves the right to change the circuitry and specifications without notice at any time.

12 Maxim Integrated Products, 120 San Gabriel Drive, Sunnyvale, CA 94086 (408) 737-7600