

產品型號
Ordering Information

勝特力材料 886-3-5753170
勝特力电子(上海) 86-21-54151736
勝特力电子(深圳) 86-755-83298787
[Http://www.100y.com.tw](http://www.100y.com.tw)



MS 3100
牆外插座
Wall Mount Receptacle



MS 3101
連線接頭
Cable Connecting Plug

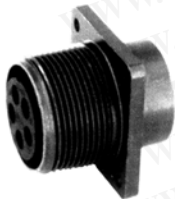

MS 3102
械外插座
Box Mounting Receptacle



MS 3106
直管接頭
Straight Plug



MS 3108
彎管接頭
90° angle Plug

MS	3106	A	20 - 16	P	W
Prefix 軍用規格 MS Military Standard					
樣式 Shell Style 表一-Ref. Table 1.					
種類 Service Class 表二-Ref. Table 2.					
外殼.本體編號 Shell Size					

接點方位
Alternate Polarization
Blank (Normal) W.X.Y.Z

接觸類型
導針P=Pin/Male
導槽S=Socket/ Female

接點規格
Insert Arrangement

表一 TABLE I. SHELL STYLE

Shell Style	MS No.	Description	Available Class
00	MS3100	Wall mounting receptacle	A.E/F.R
01	MS3101	Cable connecting plug	A.E/F.R
02	MS3102	Box mounting receptacle	A.B.E/F.R
06	MS3106	Straight plug	A.B.E/F.R
08	MS3108	90° angle plug	A.B.E/F.R
-	MS25183	Plug with potting cup	-

表二 TABLE II. SERVICE CLASS

Class	Description
A	Solid shell. Solder contacts & none pressured. 單一外殼(標準型)
B	Split shell, Solder contact & none pressured. 分割外殼, 轉動接點
E/F	Environmental use 用於環境保護
R	Solder contacts with grommet seal and without clamp 附墊圈及密封套

接頭電壓表 *Electrical Specification*

各式接頭使用電壓 Voltage Ratings

Class	Operating Volt AC	Operating Volt DC	Test rms
Inst.	200	250	1,000
A	500	700	2,000
D	900	1,250	2,800
E	1,250	1,750	3,500
B	1,750	2,450	4,500
C	3,000	4,200	7,000

接點電壓 Voltage Ratings

Contact Size	Operating Current.	Test Current Amps.	Voltage Drop mV
16	13	20	21
12	23	35	20
8	46	60	12
4	80	110	10
0	150	200	10

胜特力材料 886-3-5753170
 胜特力电子(上海) 86-21-54151736
 胜特力电子(深圳) 86-755-83298787
[Http://www.100y.com.tw](http://www.100y.com.tw)

材質 *Standard Material and Finishes*

外殼Shell (MIL-STD)	鋁合金壓鑄 Aluminum alloy, conductive olive drab chromate over cadmium (Consult Factory for Commercial options.)
絕緣體 Insulator	人工橡膠 Synthetic Rubber (B-Type = Epoxy resin)
墊圈封套 Grommet and seal	人工橡膠 Synthetic Rubber
接點 Contacts	銀鍍銅合金 Copper alloy with silver plate
熱衝擊 Temperature Range	-55°C to 125°C
Environmental Protection per MIL-C-5015 (MIL-STD 202)	

主要特性 *Characteristics*

絕緣抵抗 Insulating Resistance	5,000MΩ Minimum (at 25°C)
熱衝擊 Temperature Range	-55°C to 125°C
耐久性 Durability	500 Cycle Connector/ Disconnection

彎管接頭 MS3108 A/R Type (90° Cable Plug)

胜特力材料 886-3-5753170
 胜特力电子(上海) 86-21-54151736
 胜特力电子(深圳) 86-755-83298787
[Http://www.100y.com.tw](http://www.100y.com.tw)

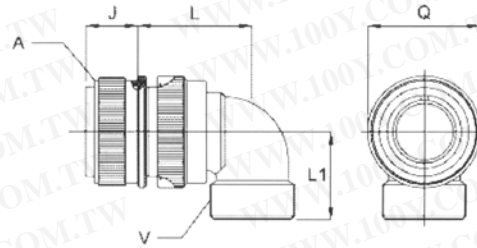

DIMENSIONS IN INCHES 英呎規格

SHELL SIZE	A Thread Class 2A	J ± .004	L ± .020	L1 ± .020	Q ± .020	V Thread Class 2A
10SL	5/8-24 UNEF	.531	.930	.945	.906	5/8-24 UNEF
14S	7/8-20 UNEF	.531	1.039	1.031	1.102	3/4-20 UNEF
16S	1-20 UNEF	.531	1.169	1.094	1.240	7/8-20 UNEF
16	1-20 UNEF	.717	1.370	1.094	1.240	7/8-20 UNEF
18	1 1/8-18 UNEF	.717	1.476	1.189	1.343	1-20 UNEF
20	1 1/4-18 UNEF	.717	1.594	1.252	1.469	13/16-18 UNEF
22	1 3/8-18 UNEF	.717	1.697	1.319	1.587	13/16-18 UNEF
24	1 1/2-18 UNEF	.717	1.744	1.378	1.713	17/16-18 UNEF
28	1 3/4-18 UNS	.717	1.835	1.476	1.965	17/16-18 UNEF
32	2-18 UNS	.717	2.063	1.713	2.213	1 3/4-18 UNS
36	2 1/4-16 UN	.717	2.220	1.831	2.468	2-18 UNS

DIMENSIONS IN MILLIMETERS 釐米規格

SHELL SIZE	A Thread Class 2A	J ± .1	L ± .5	L1 ± .5	Q ± .5	V Thread Class 2B
10SL	5/8-24 UNEF	13.5	24.9	24.0	23.0	5/8-24 UNEF
14S	7/8-20 UNEF	13.5	26.4	26.2	28.0	3/4-20 UNEF
16S	1-20 UNEF	13.5	29.7	27.8	31.5	7/8-20 UNEF
16	1-20 UNEF	18.2	34.8	27.8	31.5	7/8-20 UNEF
18	1 1/8-18 UNEF	18.2	37.5	30.2	34.1	1-20 UNEF
20	1 1/4-18 UNEF	18.2	40.5	31.8	37.3	13/16-18 UNEF
22	1 3/8-18 UNEF	18.2	43.1	33.5	40.3	13/16-18 UNEF
24	1 1/2-18 UNEF	18.2	44.3	35.0	43.5	17/16-18 UNEF
28	1 3/4-18 UNS	18.2	16.6	37.5	49.9	17/16-18 UNEF
32	2-18 UNS	18.2	52.4	43.5	56.2	1 3/4-18 UNS
36	2 1/4-16 UN	18.2	56.4	46.5	62.7	2-18 UNS

MIL-C-5015 Connectors

Basic Construction

Amphenol MIL-C-5015 connectors meet the latest performance requirements of MIL-C-5015. These connectors represent well-proven electrical capability at an acceptable cost for most equipment where durability is important. MIL-C-5015 features threaded coupling & single key & keyway polarization representing maximum simplicity in design. Applications include industrial machines, military ground support equipment, ordnance & shipboard installation. Amphenol MIL-C-5015 connectors are available in classes A, B, E/F, R, and also offers a range of pre-earth connectors. Therefore, you will always find the right connector in Amphenol, with us, for conditions & performance requirements you may have.

Specification

Materials & Finish

	Materials	Finish
Shell	Aluminum alloy	Olive drab chromate coating over Zinc plating
Contact	Brass or copper alloy	Silver plate
Insulator	Plastic or Resilient Synthetic Rubber	-

Characteristics

Insulation resistance	5,000Mega ohms minimum (at 25° C)
Temperature range	-55° C to 125° C
Durability	500 Cycle connection/disconnection

勝特力材料 886-3-5753170
勝特力电子(上海) 86-21-54151736
勝特力电子(深圳) 86-755-83298787
[Http://www.100y.com.tw](http://www.100y.com.tw)

Dielectric with standing voltage				Contact engagement and separation forces			
Service rating	Test voltage AC(rms)	Operating voltage		Contact mating end size	Minimum separation force (ounce)	Maximum average engagement force (ounce)	Maximum engagement force (ounce)
		AC	DC				
Inst.	1,000	200	250	#16	2	24	30
A	2,000	500	700	#12	3	24	30
D	2,800	900	1,250	#8	5	-	160
E	3,500	1,250	1,750	#4	10	-	240
B	4,500	1,750	2,450	#0	15	-	320
C	7,000	3,000	4,200				

Contact size			Rated current (Mated with insulators)	Contact resistance		Wire range accommodations		
Size	Pin Contact diam.	Solder pot diam.		Test current DC A	Potential drop(MAX) mV	A.W.G	Wire normal square size (好)	Dielectric material outer diam.
#16	1.6	1.9	13A	13A	49	#20~#16	~1.3	1.7~3.3
#12	2.4	3.0	23A	23A	42	#14~#12	~3.5	2.9~4.3
#8	3.6	5.4	46A	46A	26	#10~#8	~8.0	4.2~6.4

#4	5.7	8.4	80A	80A	23	#6~#4	~ 22.0	7.0~9.4
#0	9.1	12.2	150A	150A	21	#2~#0	~ 50.0	10.6~14.0

MIL-C-5015 Connectors

Ordering Information

Connector Series

Shell / Class

MS	3100	A
Series Designation	Shell Style	Service Class
MS - Amphenol MIL-C-5015 STANDARD	3100 - Wall Mounting Receptacle	A - General purpose, Solid Endbell
DS - Amphenol MIL-C-5015 Europe use	3101 - Cable Connecting Receptacle	B - General purpose, Split Endbell
DL - Amphenol MIL-C-5015 Pre-earth mating function	3102 - Box Mounting Receptacle	E - Environmental resisting with grommet seal
	3106 - Straight Plug	& strain relief backshell
	3108 - Right Angle Plug	F - Environmental resisting with grommet seal & strain relief backshell
		3106F and 3018E style include a front & O* ring seal
		R - Environmental resisting with grommet seal, light weight and shorter overall length
		3106R style include a front & O* ring seal

勝特力材料 886-3-5753170
勝特力电子(上海) 86-21-54151736
勝特力电子(深圳) 86-755-83298787
[Http://www.100y.com.tw](http://www.100y.com.tw)

Insert Arrangement / Contact Type

Deviations

18	1	S	w	xxx	
Shell Size	Insert Arrangement	Contact Type	Alternate Positioning	Deviation I, Plating	Deviation II
10SL,12S,12,14S 14,16S,16,18,20, 22,24,28,32,36	See Page 41-42	P - Pin (+), male S - Socket (-), female	No suffix-Nomal W,X,Y,Z - See Page 41-42	No suffix - Olive Drab Zinc CD - Cadimium 621 - Black Zinc 689 - Electro-less Nickel 426 - Electro-less Nickel & Gold Flash Contact Others - Consult Amphenol	No Suffix - Standard K - Japan Use, Plastic Insert KR - Japan Use, Rubber Insert

Accessories

Series

Type

Size

MS

25042

10

Series Designation

Type

Size

MS - Amphenol MIL-C-5015 STANDARD

25042 - Protection Cap, 3106, 3108 Shell Style Plug

DS - Amphenol MIL-C-5015 Europe use

25043 - Protection Cap, 3100, 3101, 3102 Shell Style

Receptacle

3057 -Cable Clamp

3420 -Telescoping Bushing

BMA31 -Gasket

DL - Amphenol MIL-C-5015 Pre-earth
mating function

3057 -Cable Clamp

3420 - Telescoping Bushing

BMA31 -Gasket

勝特力材料 886-3-5753170
 勝特力电子(上海) 86-21-54151736
 勝特力电子(深圳) 86-755-83298787
[Http://www.100y.com.tw](http://www.100y.com.tw)

Typical Mating Guide



MIL-C-5015 connectors

MS/DS Series

'A' class



Wall Mounting Receptacle

MS-A class connectors perform many of the virtual functions in powering, testing and ground support system. Class A applications include communications equipment, computers and shipboard installation where mechanical forces and physical parameters are not subject to extreme or rapid environmental changes.

Shells:

Shell components are fabricated from high grade aluminum alloy. Electrically conductive Zinc plate finish with an olive drab chromate after treatment offers corrosion resistance.

Contacts:

Pins and sockets are machined from copper alloy with silver plated finish. Size 16 and 12 socket contacts incorporate a closed entry design.

Inserts:

Inserts are resilient synthetic rubber, offering high dielectric strength, high arc resistance arc resistance to vibration.

Proprietary design permits pressurization of either pin or socket insert.



Cable Connecting Receptacle



Box Mounting Receptacle



Straight Plug



Right Angle Plug

勝特力材料 886-3-5753170
勝特力电子(上海) 86-21-54151736
勝特力电子(深圳) 86-755-83298787
[Http://www.100y.com.tw](http://www.100y.com.tw)

MIL-C-5015 connectors

'A' class Dimension

Wall Mounting Receptacle
Solid Endbell
MS3100A

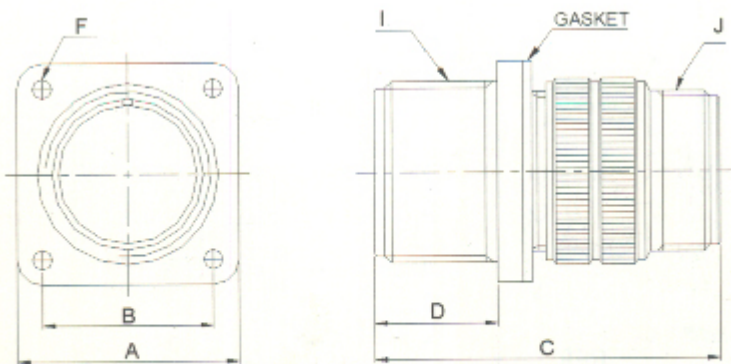

勝特力材料 886-3-5753170
勝特力电子(上海) 86-21-54151736
勝特力电子(深圳) 86-755-83298787
[Http://www.100y.com.tw](http://www.100y.com.tw)

MS3100A wall mounting receptacles are used with the MS3057 cable clamp or with conduit to eliminate need for the conduit box in applications where wires are carried thru walls or bulkheads.

(mm)

Shell Size	f A ± 0.79	f B ±0.12	C Max	D +0.79 -0.00	ØF +0.25 -0.12	I Thread-2A	J Thread-2A
10SL	25.40	18.26	38.88	14.28	3.05	5/8-24 UNEF	5/8-24 UNEF
12S	27.79	20.62	42.87	14.28	3.05	3/4-20 UNEF	5/8-24 UNEF
12	27.79	20.62	52.37	19.05	3.05	3/4-20 UNEF	5/8-24 UNEF
14S	30.18	23.01	42.87	14.28	3.05	7/8-20 UNEF	3/4-20 UNEF
14	30.18	23.01	52.37	19.05	3.05	7/8-20 UNEF	3/4-20 UNEF
16S	32.54	24.61	42.87	14.28	3.05	1-20 UNEF	7/8-20 UNEF
16	32.54	24.61	52.37	19.05	3.05	1-20 UNEF	7/8-20 UNEF
18	34.93	26.97	52.37	19.05	3.05	1 1/8-18 UNEF	1-20 UNEF
20	38.10	29.36	55.57	19.05	3.05	1 1/4-18 UNEF	1 3/16-18 UNEF
22	41.28	31.75	55.57	19.05	3.05	1 3/8-18 UNEF	1 3/16-18 UNEF
24	44.45	34.93	58.72	20.63	3.73	1 1/2-18 UNEF	1 7/16-18 UNEF
28	50.80	39.67	58.72	20.63	3.73	1 3/4-18 UNEF	1 7/16-18 UNEF
32	57.15	44.45	61.92	22.23	4.39	2-18 UNS	1 3/4-18 UNS
36	63.50	49.23	61.92	22.23	4.39	2 1/4-16 UN	2-18 UNS

MIL-C-5015 connectors

'A' class Dimension

Cable Connecting Receptacle

Solid Endbell

MS3101A

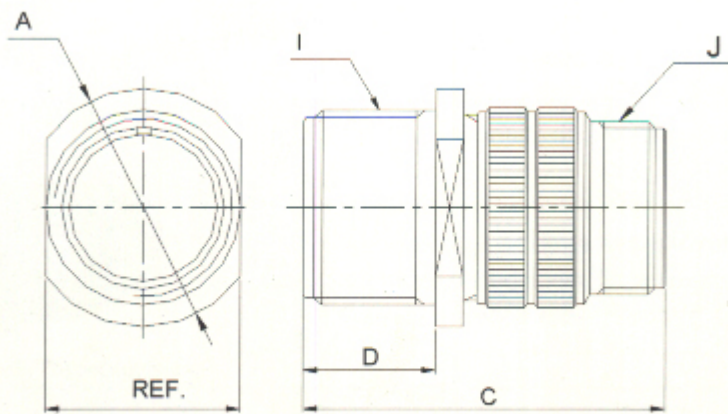

勝特力材料 886-3-5753170
 勝特力电子(上海) 86-21-54151736
 勝特力电子(深圳) 86-755-83298787
[Http://www.100y.com.tw](http://www.100y.com.tw)

MS3101A solid endbell cable connecting receptacles are used for cable extension requirements where mounting provisions are unnecessary.(mm)

Shell Size	ØA Max	C Max	D +0.79 -0.00	I Thread-2A	J Thread-2A
10SL	24.61	38.88	14.28	5/8-24 UNEF	5/8-24 UNEF
12S	26.97	42.87	14.28	3/4-20 UNEF	5/8-24 UNEF
12	26.97	52.37	19.05	3/4-20 UNEF	5/8-24 UNEF
14S	29.36	42.87	14.28	7/8-20 UNEF	3/4-20 UNEF
14	29.36	52.37	19.05	7/8-20 UNEF	3/4-20 UNEF
16S	31.75	42.87	14.28	1-20 UNEF	7/8-20 UNEF
16	31.75	52.37	19.05	1-20 UNEF	7/8-20 UNEF
18	34.13	52.37	19.05	1 1/8-18 UNEF	1-20 UNEF
20	37.31	55.57	19.05	1 1/4-18 UNEF	1 3/16-18 UNEF
22	40.48	55.57	19.05	1 3/8-18 UNEF	1 3/16-18 UNEF
24	43.66	58.72	20.63	1 1/2-18 UNEF	1 7/16-18 UNEF
28	50.01	58.72	20.63	1 3/4-18 UNEF	1 7/16-18 UNEF
32	56.36	61.92	22.23	2-18 UNS	1 3/4-18 UNS
36	62.71	61.92	22.23	2 1/4-16 UN	2-18 UNS

MIL-C-5015 connectors

'A' class Dimension

Box Mounting Receptacle(Available with Plastic or Rubber insulators)

MS3102A

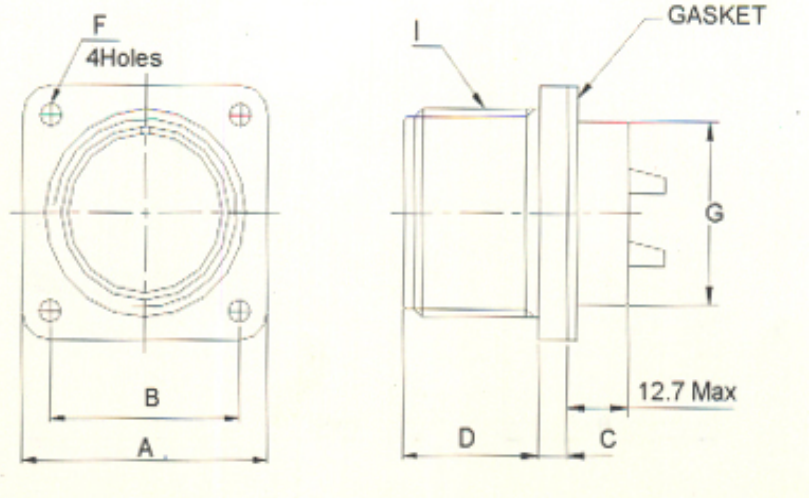

勝特力材料 886-3-5753170
 勝特力电子(上海) 86-21-54151736
 勝特力电子(深圳) 86-755-83298787
[Http://www.100y.com.tw](http://www.100y.com.tw)

MS3102A box mounting receptacles are used on boxes and equipment cases where no cable support is required.

(mm)

Shell Size	f A ± 0.79	f B ± 0.12	C ± 0.3	D +0.79 -0.00	ØF +0.25 -0.12	ØG Max	I Thread-2A
10SL	25.40	18.26	3.0	14.28	3.05	16.0	5/8-24 UNEF
12S	27.79	20.62	3.0	14.28	3.05	16.5	3/4-20 UNEF
12	27.79	20.62	3.0	19.05	3.05	16.5	3/4-20 UNEF
14S	30.18	23.01	3.0	14.28	3.05	20.0	7/8-20 UNEF
14	30.18	23.01	3.0	19.05	3.05	20.0	7/8-20 UNEF
16S	32.54	24.61	3.0	14.28	3.05	23.0	1-20 UNEF
16	32.54	24.61	3.0	19.05	3.05	23.0	1-20 UNEF
18	34.93	26.97	4.0	19.05	3.05	26.0	1 1/8-18 UNEF
20	38.10	29.36	4.0	19.05	3.05	29.0	1 1/4-18 UNEF
22	41.28	31.75	4.0	19.05	3.05	32.5	1 3/8-18 UNEF
24	44.45	34.93	4.0	20.63	3.73	35.5	1 1/2-18 UNEF
28	50.80	39.67	4.0	20.63	3.73	42.0	1 3/4-18 UNEF
32	57.15	44.45	4.0	20.63	4.39	48.0	2-18 UNS
36	63.50	49.23	4.0	20.63	4.39	54.5	2 1/4-16 UN

MIL-C-5015 connectors

'A' class Dimension

Straight Plug
 Solid Endbell
MS3106A

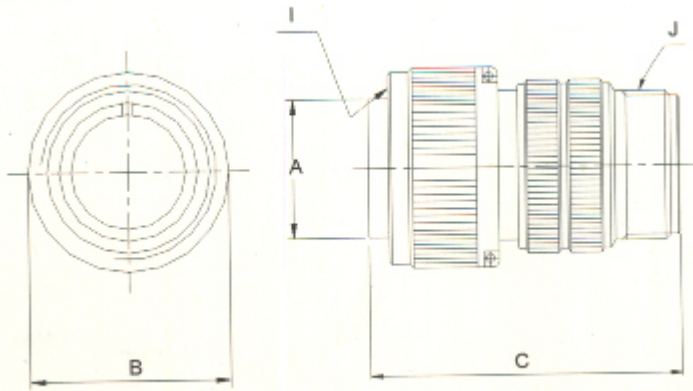

勝特力材料 886-3-5753170
 勝特力电子(上海) 86-21-54151736
 勝特力电子(深圳) 86-755-83298787
[Http://www.100y.com.tw](http://www.100y.com.tw)

MS3106A straight plugs are used with 3100,3101 and 3102 receptacles. (mm)

Shell Size	ØA +0.00 -0.38	ØB Max	C Max	I Thread-2B	J Thread-2A
10SL	25.40	18.26	38.88	5/8-24 UNEF	5/8-24 UNEF
12S	27.79	20.62	42.87	3/4-20 UNEF	5/8-24 UNEF
12	27.79	20.62	52.37	3/4-20 UNEF	5/8-24 UNEF
14S	30.18	23.01	42.87	7/8-20 UNEF	3/4-20 UNEF
14	30.18	23.01	52.37	7/8-20UNEF	3/4-20 UNEF
16S	32.54	24.61	42.87	1-20UNEF	7/8-20 UNEF
16	32.54	24.61	52.37	1-20UNEF	7/8-20 UNEF
18	34.93	26.97	52.37	1 1/8-18 UNEF	1-20UNEF
20	38.10	29.36	55.57	1 1/4-18 UNEF	1 3/16-18 UNEF
22	41.28	31.75	55.57	1 3/8-18 UNEF	1 3/16-18 UNEF
24	44.45	34.93	58.72	1 1/2-18 UNEF	1 7/16-18 UNEF
28	50.80	39.67	58.72	1 3/4-18 UNEF	1 7/16-18 UNEF
32	57.15	44.45	61.92	2-18 UNS	1 3/4-18 UNS
36	63.50	49.23	61.92	2 1/4-16 UN	2-18 UNS

MIL-C-5015 connectors

'A' class Dimension

Right Angle Plug

Solid Endbell

MS3108A

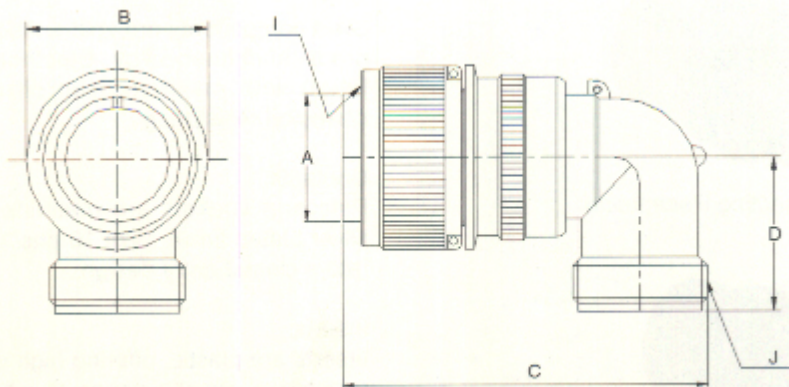

勝特力材料 886-3-5753170
 勝特力电子(上海) 86-21-54151736
 勝特力电子(深圳) 86-755-83298787
[Http://www.100y.com.tw](http://www.100y.com.tw)

MS3108A Right Angle plugs, have a solid endbell and are used where wire must be brought at an abrupt angle.

Either the split or solid endbells on the 3108 are capable of being rotated and locked.

(mm)

Shell Size	$\varnothing A$ +0.00 -0.38	$\varnothing B$ Max	C Max	D Max	I Thread-2B	J Thread-2A
10SL	11.33	24.61	46.02	25.4	5/8-24 UNEF	5/8-24 UNEF
12S*	14.10	26.97	50.80	26.9	3/4-20 UNEF	5/8-24 UNEF
12	14.10	26.97	57.15	26.9	3/4-20 UNEF	5/8-24 UNEF
14S	17.15	29.36	53.97	28.5	7/8-20 UNEF	3/4-20 UNEF
14	17.15	29.36	58.72	28.5	7/8-20 UNEF	3/4-20 UNEF
16S	20.45	31.75	60.32	30.1	1-20 UNEF	7/8-20 UNEF
16	20.45	31.75	65.07	30.1	1-20 UNEF	7/8-20 UNEF
18	23.62	34.13	68.27	33.3	1 1/8-18 UNEF	1-20 UNEF
20	26.67	37.71	76.98	34.9	1 1/4-18 UNEF	1 3/16-18 UNEF
22	29.85	40.48	76.98	34.9	1 3/8-18 UNEF	1 3/16-18 UNEF
24	33.02	43.66	86.51	39.6	1 1/2-18 UNEF	1 7/16-18 UNEF
28	38.61	50.01	86.51	39.6	1 3/4-18 UNEF	1 7/16-18 UNEF
32	44.96	56.36	95.25	47.6	2-18 UNS	1 3/4-18 UNS
36	50.29	62.71	100.02	52.3	2 1/4-16 UN	2-18 UNS

MIL-C-5015 connectors

MS/DS Series

'B' class



Cable Connecting Receptacle

MS-B class connector is a general duty standard cylindrical connector. It is a widely used for the automotive, machine tool & welding industries, as well as numerous other commercial applications, where mechanical forces and physical parameters are not subject to extreme or rapid environmental changes. UL, approved

Shells:

Shell components are split endbell and fabricated from high grade aluminum alloy. Electrically conductive Zinc plate finish with an olive drab chromate after-treat offers corrosion resistance.

Contacts:

Pins and sockets are machined from copper alloy with silver plated finish. Size 16 and 12 socket contacts incorporate a closed entry design.

Inserts:

Inserts are plastic, offering high dielectric strength, high arc resistance arc resistance to vibration. Proprietary design permits pressurization of either pin or socket.



Straight Plug



Right Angle Plug

勝特力材料 886-3-5753170
勝特力电子(上海) 86-21-54151736
勝特力电子(深圳) 86-755-83298787
[Http://www.100y.com.tw](http://www.100y.com.tw)

MIL-C-5015 connectors

'B' class Dimension

Cable Connecting Receptacle

Split Endbell

MS3101B

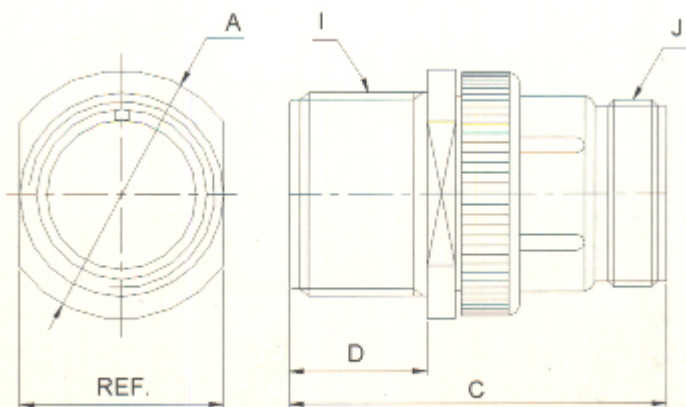

勝特力材料 886-3-5753170
 勝特力电子(上海) 86-21-54151736
 勝特力电子(深圳) 86-755-83298787
[Http://www.100y.com.tw](http://www.100y.com.tw)

MS3101B split endbell cable connecting receptacles are used for cable extension requirements where mounting provisions are unnecessary.

(mm)

Shell Size	ØA Max	C Max	D +0.79 -0.00	I Thread-2A	J Thread-2A
10SL	24.61	38.88	14.28	5/8-24 UNEF	5/8-24 UNEF
12S*	26.97	42.87	14.28	3/4-20 UNEF	5/8-24 UNEF
12*	26.97	52.37	19.05	3/4-20 UNEF	5/8-24 UNEF
14S	29.36	42.87	14.28	7/8-20 UNEF	3/4-20 UNEF
14	29.36	52.37	19.05	7/8-20UNEF	3/4-20 UNEF
16S	31.75	42.87	14.28	1-20UNEF	7/8-20 UNEF
16	31.75	52.37	19.05	1-20UNEF	7/8-20 UNEF
18	34.13	52.37	19.05	1 1/8-18 UNEF	1-20UNEF
20	37.31	55.57	19.05	1 1/4-18 UNEF	1 3/16-18 UNEF
22	40.48	55.57	19.05	1 3/8-18 UNEF	1 3/16-18 UNEF
24	43.66	58.72	20.63	1 1/2-18 UNEF	1 7/16-18 UNEF
28	50.01	58.72	20.63	1 3/4-18 UNEF	1 7/16-18 UNEF
32	56.36	61.92	22.23	2-18 UNS	1 3/4-18 UNS
36	62.71	61.92	22.23	2 1/4-16 UN	2-18 UNS

MIL-C-5015 connectors

'B' class Dimension

Straight Plug

Split Endbell

MS3106B

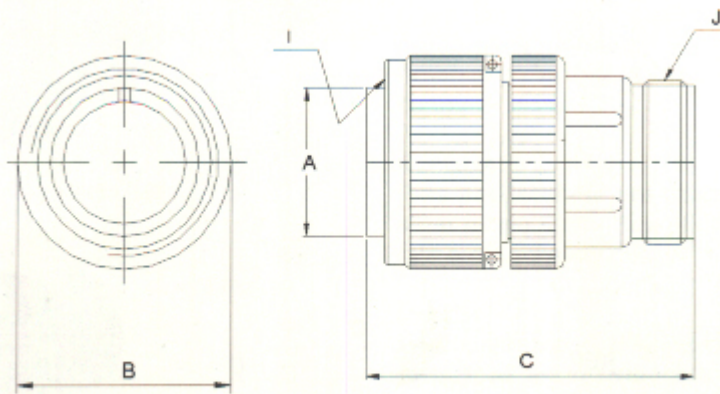

勝特力材料 886-3-5753170
 勝特力电子(上海) 86-21-54151736
 勝特力电子(深圳) 86-755-83298787
[Http://www.100y.com.tw](http://www.100y.com.tw)

MS3106B straight plugs with split endbell are used with 3100,3101 and 3102 receptacles. (mm)

Shell Size	ØA +0.00 -0.38	ØB Max	C Max	I Thread-2B	J Thread-2A
10SL	11.33	24.61	38.88	5/8-24 UNEF	5/8-24 UNEF
12S*	14.10	26.97	42.87	3/4-20 UNEF	5/8-24 UNEF
12*	14.10	26.97	52.37	3/4-20 UNEF	5/8-24 UNEF
14S	17.15	29.36	42.87	7/8-20 UNEF	3/4-20 UNEF
14	17.15	29.36	52.37	7/8-20UNEF	3/4-20 UNEF
16S	20.45	31.75	42.87	1-20UNEF	7/8-20 UNEF
16	20.45	31.75	52.37	1-20UNEF	7/8-20 UNEF
18	23.62	34.13	52.37	1 1/8-18 UNEF	1-20UNEF
20	26.67	37.31	55.57	1 1/4-18 UNEF	1 3/16-18 UNEF
22	29.85	40.48	55.57	1 3/8-18 UNEF	1 3/16-18 UNEF
24	33.02	43.66	58.72	1 1/2-18 UNEF	1 7/16-18 UNEF
28	38.61	50.01	58.72	1 3/4-18 UNEF	1 7/16-18 UNEF
32	44.96	56.36	61.92	2-18 UNS	1 3/4-18 UNS
36	50.29	62.71	61.92	2 1/4-16 UN	2-18 UNS

MIL-C-5015 connectors

'B' class Dimension

Right Angle Plug

Split Endbel

MS3108B

勝特力材料 886-3-5753170
 勝特力电子(上海) 86-21-54151736
 勝特力电子(深圳) 86-755-83298787
[Http://www.100y.com.tw](http://www.100y.com.tw)

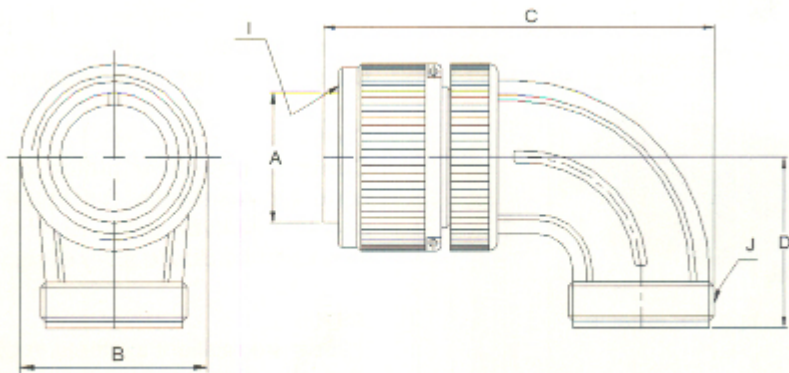

MS3108B Right angle plugs, have a split endbell and are used where wires must be brought at an abrupt angle.

Either the split or solid endbells on the 3108 are capable of being rotated and locked.(mm)

Shell Size	ØA +0.00 -0.38	ØB Max	C Max	D Max	I Thread-2B	J Thread-2A
10SL	11.33	24.61	46.02	25.4	5/8-24 UNEF	5/8-24 UNEF
12S*	14.10	26.97	50.80	26.9	3/4-20 UNEF	5/8-24 UNEF
12*	14.10	26.97	57.15	26.9	3/4-20 UNEF	5/8-24 UNEF
14S	17.15	29.36	53.97	28.5	7/8-20 UNEF	3/4-20 UNEF
14	17.15	29.36	58.72	28.5	7/8-20UNEF	3/4-20 UNEF
16S*	20.45	31.75	60.32	30.1	1-20UNEF	7/8-20 UNEF
16*	20.45	31.75	65.07	30.1	1-20UNEF	7/8-20 UNEF
18	23.62	34.13	68.27	33.3	1 1/8-18 UNEF	1-20UNEF
20	26.67	37.31	76.98	34.9	1 1/4-18 UNEF	1 3/16-18 UNEF
22	29.85	40.48	76.98	34.9	1 3/8-18 UNEF	1 3/16-18 UNEF
24	33.02	43.66	86.51	39.6	1 1/2-18 UNEF	1 7/16-18 UNEF
28	38.61	50.01	86.51	39.6	1 3/4-18 UNEF	1 7/16-18 UNEF
32	44.96	56.36	95.25	47.6	2-18 UNS	1 3/4-18 UNS
36	50.29	62.71	100.02	52.3	2 1/4-16 UN	2-18 UNS

MIL-C-5015 connectors

MS/DS Series

'E/F' class



Wall Mounting Receptacle

These MS connectors satisfy all the performance requirements of MIL-C-5015 and are recommended for conditions where vibration, moisture, pressure and/or temperature and extreme. Strain relief is supplied on most shell sizes.

Shells:

Shell components are fabricated from high grade aluminum alloy. The standard hardware plating is electrically conductive Zinc plated finish with an olive drab chromate after treatment for corrosion resistance. Consult Amphenol Daeshin for other plating options.

Contacts:

Contacts are silver plated copper alloy for maximum corrosion resistance, maximum current carrying capacity and low millivolt drop. Size 16 and 12 socket contacts incorporate a closed entry design.



Cable Connecting Receptacle

Inserts:

Inserts are resilient synthetic rubber, offering high dielectric strength, high arc resistance arc resistance to vibration. Proprietary design permits pressurization of either pin or socket insert.

Strain Relief Clamp:

Strain relief clamp minimizes tension at the solder well connection and provides a positive mechanical moisture seal. Complete field serviceability is possible with the strain relief clamp.



Box Mounting Receptacle

勝特力材料 886-3-5753170
勝特力电子(上海) 86-21-54151736
勝特力电子(深圳) 86-755-83298787
[Http://www.100y.com.tw](http://www.100y.com.tw)



Straight Plug



Right Angle Plug

MIL-C-5015 connectors

'E/F' class Dimension

Wall Mounting Receptacle

Integral Cable Clamp

MS3100E/MS3100F

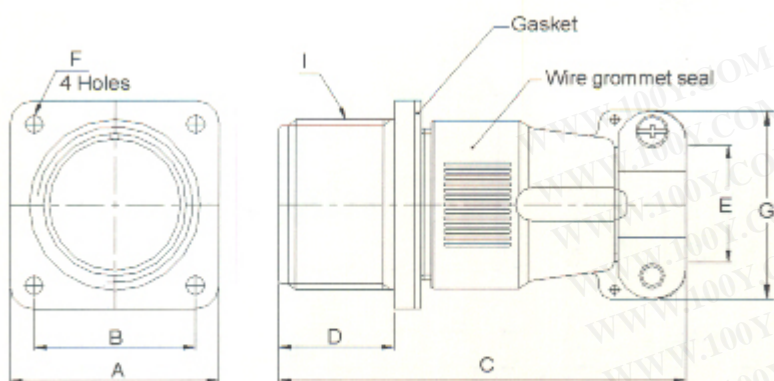

勝特力材料 886-3-5753170
 勝特力电子(上海) 86-21-54151736
 勝特力电子(深圳) 86-755-83298787
[Http://www.100y.com.tw](http://www.100y.com.tw)

MS3100E/F wall mounting receptacles are used to carry wires thru walls or bulkheads, or to provide a means of disconnection at a bulkhead. MS 3100E/F receptacles mate with 3106 and 3108 plugs.

(mm)

Shell Size	± A ± 0.79	± B ± 0.12	C Max	D +0.79 -0.00	ØE Max	ØF +0.25 -0.12	ØG Max	I Thread-2A
10SL	25.40	18.26	57.15	14.28	7.9	3.05	23.0	5/8-24 UNEF
12S	27.79	20.62	57.15	14.28	7.9	3.05	23.0	3/4-20 UNEF
12	27.79	20.62	66.67	19.05	7.9	3.05	23.0	3/4-20 UNEF
14S	30.18	23.01	57.15	14.28	11.2	3.05	26.0	7/8-20 UNEF
14	30.18	23.01	66.67	19.05	11.2	3.05	26.0	7/8-20 UNEF
16S	32.54	24.61	57.15	14.28	14.2	3.05	29.0	1-20 UNEF
16	32.54	24.61	66.67	19.05	14.2	3.05	29.0	1-20 UNEF
18	34.93	26.97	68.27	19.05	16.0	3.05	31.6	1 1/8-18 UNEF
20	38.10	29.36	69.85	19.05	19.1	3.05	37.5	1 1/4-18 UNEF
22	41.28	31.75	69.85	19.05	19.1	3.05	37.5	1 3/8-18 UNEF
24	44.45	34.93	75.41	20.63	23.8	3.73	43.0	1 1/2-18 UNEF
28	50.80	39.67	76.98	20.63	23.8	3.73	43.0	1 3/4-18 UNEF

32	57.15	44.45	76.98	22.23	32.0	4.39	52.0	2-18 UNS
36	63.50	49.23	83.33	22.23	35.0	4.39	58.0	2 1/4-16 UN

MIL-C-5015 connectors

'E/F' class Dimension

Cable Connecting Receptacle

Integral Cable Clamp

MS3101E/MS3101F

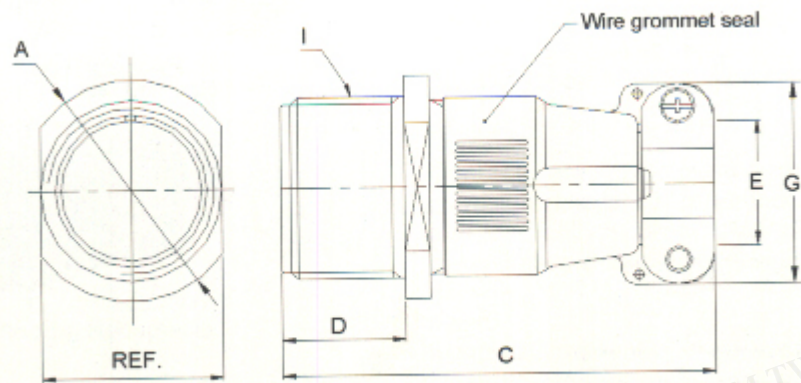

勝特力材料 886-3-5753170
 勝特力电子(上海) 86-21-54151736
 勝特力电子(深圳) 86-755-83298787
[Http://www.100y.com.tw](http://www.100y.com.tw)

MS3101E/F cable connecting receptacles are used for cable extension requirements, where mounting provisions are unnecessary.

MS3101E/F receptacles mate with 3106 and 3108 plugs.

(mm)

Shell Size	A Max	C Max	D +0.79 -0.00	Ø E Max	Ø G Max	I Thread-2A
10SL	25.40	57.15	14.28	7.9	23.0	5/8-24 UNEF
12S	27.79	57.15	14.28	7.9	23.0	3/4-20 UNEF
12	27.79	66.67	19.05	7.9	23.0	3/4-20 UNEF
14S	30.18	57.15	14.28	11.2	26.0	7/8-20 UNEF
14	30.18	66.67	19.05	11.2	26.0	7/8-20UNEF
16S	32.54	57.15	14.28	14.2	29.0	1-20UNEF
16	32.54	66.67	19.05	14.2	29.0	1-20UNEF
18	34.93	68.27	19.05	16.0	31.6	1 1/8-18 UNEF
20	38.10	69.85	19.05	19.1	37.5	1 1/4-18 UNEF
22	41.28	69.85	19.05	19.1	37.5	1 3/8-18 UNEF
24	44.45	75.41	20.63	23.8	43.0	1 1/2-18 UNEF
28	50.80	76.98	20.63	23.8	43.0	1 3/4-18 UNEF
32	57.15	76.98	22.23	32.0	52.0	2-18 UNS
36	63.50	83.33	22.23	35.0	58.0	2 1/4-16 UN

MIL-C-5015 connectors

'E/F' class Dimension

Box Mounting Receptacle

MS3102E

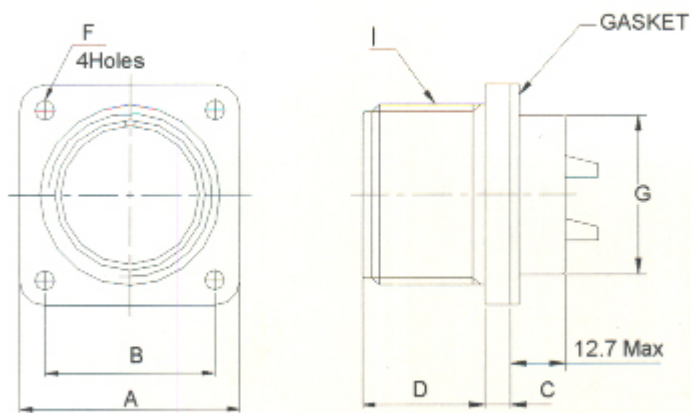

勝特力材料 886-3-5753170
 勝特力电子(上海) 86-21-54151736
 勝特力电子(深圳) 86-755-83298787
[Http://www.100y.com.tw](http://www.100y.com.tw)

MS3102E box mounting receptacles are used in junction boxes or as an integral part of equipment.

These connectors are identical with 3102A in construction.

(mm)

Shell Size	±A ± 0.79	±B ±0.12	C ± 0.3	D +0.79 -0.00	ØF +0.25 -0.12	ØG Max	I Thread-2A
10SL	25.40	18.26	3.0	14.28	3.05	16.0	5/8-24 UNEF
12S	27.79	20.62	3.0	14.28	3.05	16.5	3/4-20 UNEF
12	27.79	20.62	3.0	19.05	3.05	16.5	3/4-20 UNEF
14S	30.18	23.01	3.0	14.28	3.05	20.0	7/8-20 UNEF
14	30.18	23.01	3.0	19.05	3.05	20.0	7/8-20UNEF
16S	32.54	24.61	3.0	14.28	3.05	23.0	1-20UNEF
16	32.54	24.61	3.0	19.05	3.05	23.0	1-20UNEF
18	34.93	26.97	4.0	19.05	3.05	26.0	1 1/8-18 UNEF
20	38.10	29.36	4.0	19.05	3.05	29.0	1 1/4-18 UNEF
22	41.28	31.75	4.0	19.05	3.05	32.5	1 3/8-18 UNEF
24	44.45	34.93	4.0	20.63	3.73	35.5	1 1/2-18 UNEF
28	50.80	39.67	4.0	20.63	3.73	42.0	1 3/4-18 UNEF
32	57.15	44.45	4.0	22.23	4.39	48.0	2-18 UNS
36	63.50	49.23	4.0	22.23	4.39	54.5	2 1/4-16 UN

MIL-C-5015 connectors

'E/F' class Dimension

Straight Plug

Integral Cable Clamp

MS3106E/MS3106F

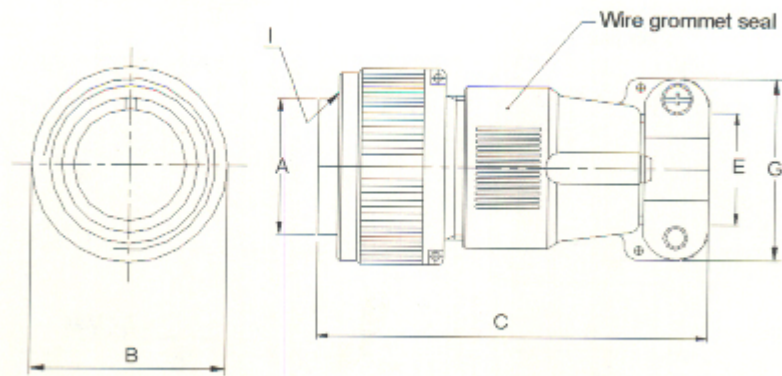

勝特力材料 886-3-5753170
 勝特力电子(上海) 86-21-54151736
 勝特力电子(深圳) 86-755-83298787
[Http://www.100y.com.tw](http://www.100y.com.tw)

MS3106E/F straight plugs mate with 3100,3101 and 3102 receptacles

(mm)

Shell Size	A +0.00 -0.38	B MAX	C Max	Ø E Max	Ø G Max	I Thread-2B
10SL	11.33	24.61	57.15	7.9	23.0	5/8-24 UNEF
12S	14.10	26.97	57.15	7.9	23.0	3/4-20 UNEF
12	14.10	26.97	66.67	7.9	23.0	3/4-20 UNEF
14S	17.15	29.36	57.15	11.2	26.0	7/8-20 UNEF
14	17.15	29.36	66.67	11.2	26.0	7/8-20UNEF
16S	20.45	31.75	57.15	14.2	29.0	1-20UNEF
16	20.45	31.75	66.67	14.2	29.0	1-20UNEF
18	23.62	34.13	68.27	16.0	31.6	1 1/8-18 UNEF
20	26.67	37.31	69.85	19.1	37.5	1 1/4-18 UNEF
22	29.85	40.48	69.85	19.1	37.5	1 3/8-18 UNEF
24	33.02	43.66	75.41	23.8	43.0	1 1/2-18 UNEF
28	38.61	50.01	76.98	23.8	43.0	1 3/4-18 UNEF
32	44.96	56.36	76.98	32.0	52.0	2-18 UNS
36	50.29	62.71	83.33	35.0	58.0	2 1/4-16 UN

MIL-C-5015 connectors

'E/F' class Dimension

Right Angle Plug

MS3108E

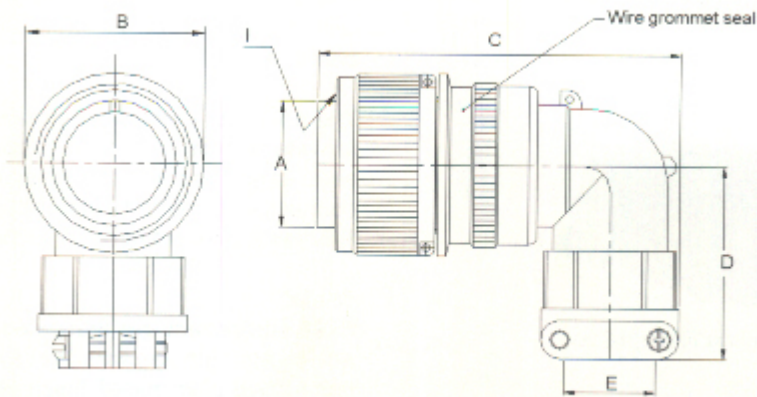

勝特力材料 886-3-5753170
 勝特力电子(上海) 86-21-54151736
 勝特力电子(深圳) 86-755-83298787
[Http://www.100y.com.tw](http://www.100y.com.tw)

MS3108E Right angle plugs are used where there is limited space and where wires must be brought at abrupt angles.

This plugmate with 3100,3101 and 3102 receptacles.

(mm)

Shell Size	A +0.00 -0.38	B MAX	C Max	D Max	Ø E Max	I Thread-2B
10SL	11.33	24.61	55.57	38.1	7.9	5/8-24 UNEF
12S*	14.10	26.97	55.57	38.1	7.9	3/4-20 UNEF
12*	14.10	26.97	64.28	38.1	7.9	3/4-20 UNEF
14S	17.15	29.36	58.72	40.4	11.2	7/8-20 UNEF
14	17.15	29.36	68.27	40.4	11.2	7/8-20UNEF
16S	20.45	31.75	61.11	42.8	14.2	1-20UNEF
16	20.45	31.75	70.63	42.8	14.2	1-20UNEF
18	23.62	34.13	72.23	45.2	16.0	1 1/8-18 UNEF
20	26.67	37.31	82.55	50.0	19.1	1 1/4-18 UNEF
22	29.85	40.48	82.55	50.8	19.1	1 3/8-18 UNEF
24	33.02	43.66	94.46	53.9	23.8	1 1/2-18 UNEF
28	38.61	50.01	94.46	55.5	23.8	1 3/4-18 UNEF
32	44.96	56.36	106.37	65.8	32.0	2-18 UNS
36	50.29	62.71	109.14	69.0	35.0	2 1/4-16 UN

MIL-C-5015 connectors

MS/DS Series

'R' class



Wall Mounting Receptacle

Specification requirements for greater reliability in a shorter, lighter weight environmental resistant connector led to the design of the MS-R.

This low profile assembly was attained by moving the axial compression nut and grommet assembly forward and flash with the rear of the insert. The silicon rubber grommet, with its low coefficient of friction, assures easier threading of wire bundles and quicker assembly and serviceability of the unit. Molded webs in each wire hole insure a moisture barrier around each wire.

The addition 'O'ring at the main joint of all MS3106R plugs provide a main joint seal supplementary to the interfacial seal, thus insuring of higher degree of reliability when connector halves from different sources are employed. MS-R types are recommended for new design applications.



Cable Connecting Receptacle

Shells:

Shell component are fabricated from high grade aluminum alloy. All components have the standard electrically conductive zinc plated finish with an olive drab chromate after treatment for corrosion resistance. Consult Amphenol Daeshin for other plating options.

Contacts:

Contacts are machined from copper alloy for maximum current carrying capacity and low millivolt drop.

Inserts:

Resilient synthetic rubber insert provide an outstanding moisture barrier, maximum vibration resistance and high dielectric strength. Either pin or socket insert can be pressurized.



Box Mounting Receptacle



Straight Plug

勝特力材料 886-3-5753170
勝特力电子(上海) 86-21-54151736
勝特力电子(深圳) 86-755-83298787
[Http://www.100y.com.tw](http://www.100y.com.tw)



Right Angle Plug

MIL-C-5015 connectors

'R' class Dimension

Wall Mounting Receptacle

MS3100R

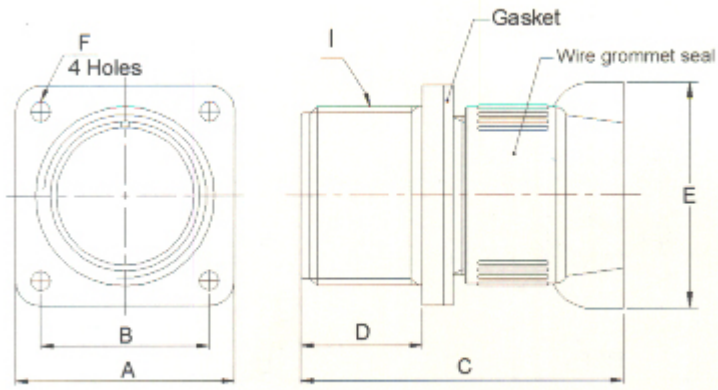

勝特力材料 886-3-5753170
 勝特力电子(上海) 86-21-54151736
 勝特力电子(深圳) 86-755-83298787
[Http://www.100y.com.tw](http://www.100y.com.tw)

MS3100R receptacles are identical in purpose to the MS3100F.

The MS3100R features a shorter lightweight endbell.

(mm)

Shell Size	±A ±0.79	±B ±0.12	C Max	D +0.79 -0.00	ØE Max	ØF +0.25 -0.12	I Thread-2A
10SL	25.40	18.26	46.68	14.28	24.0	3.05	5/8-24 UNEF
12S	27.79	20.62	46.68	14.28	24.0	3.05	3/4-20 UNEF
12	27.79	20.62	55.39	19.05	24.0	3.05	3/4-20 UNEF
14S	30.18	23.01	46.68	14.28	27.6	3.05	7/8-20 UNEF
14	30.18	23.01	66.67	19.05	11.2	3.05	7/8-20UNEF
16S	32.54	24.61	46.68	14.28	31.2	3.05	1-20UNEF
16	32.54	24.61	55.39	19.05	31.2	3.05	1-20UNEF
18	34.93	26.97	57.93	19.05	36.2	3.05	1 1/8-18 UNEF
20	38.10	29.36	57.93	19.05	39.8	3.05	1 1/4-18 UNEF
22	41.28	31.75	57.93	19.05	39.8	3.05	1 3/8-18 UNEF
24	44.45	34.93	57.93	20.63	46.0	3.73	1 1/2-18 UNEF
28	50.80	39.67	57.93	20.63	46.0	3.73	1 3/4-18 UNEF
32	57.15	44.45	57.93	22.23	53.5	4.39	2-18 UNS
36	63.50	49.23	58.97	22.23	60.0	4.39	2 1/4-16 UN

MIL-C-5015 connectors

'R' class Dimension

Cable Connecting Receptacle

MS3101R

(Receptacle with no mounting flange)

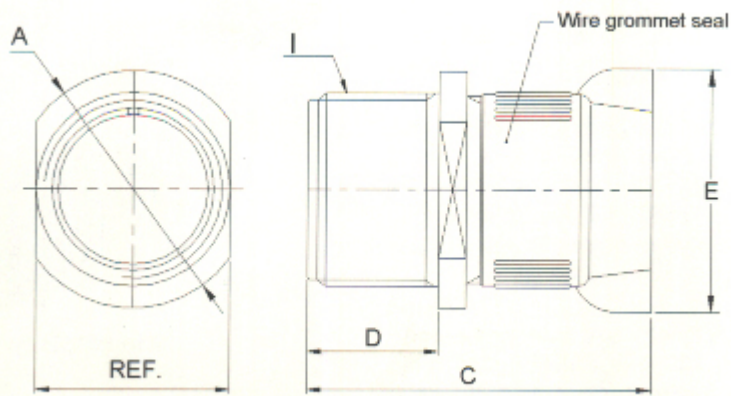

勝特力材料 886-3-5753170
 勝特力电子(上海) 86-21-54151736
 勝特力电子(深圳) 86-755-83298787
[Http://www.100y.com.tw](http://www.100y.com.tw)

MS3101R cable connecting receptacles are identical in purpose to the MS3101E.

The MS3101R features a shorter lightweight endbell.(mm)

Shell Size	A MAX	C Max	D +0.79 -0.00	Ø E Max	I Thread-2A
10SL	24.61	46.68	14.28	24.0	5/8-24 UNEF
12S	26.97	46.68	14.28	24.0	3/4-20 UNEF
12	26.97	55.39	19.05	24.0	3/4-20 UNEF
14S	29.36	46.68	14.28	27.6	7/8-20 UNEF
14	29.36	55.39	19.05	27.6	7/8-20UNEF
16S	31.75	46.68	14.28	31.2	1-20UNEF
16	31.75	55.39	19.05	31.2	1-20UNEF
18	34.13	57.93	19.05	36.2	1 1/8-18 UNEF
20	37.31	57.93	19.05	39.8	1 1/4-18 UNEF
22	40.48	57.93	19.05	39.8	1 3/8-18 UNEF
24	43.66	57.93	20.63	46.0	1 1/2-18 UNEF
28	50.01	57.93	20.63	46.0	1 3/4-18 UNEF
32	56.36	57.93	22.23	53.5	2-18 UNS
36	62.71	58.97	22.23	60.0	2 1/4-16 UN

MIL-C-5015 connectors

'R' class Dimension

Box Mounting Receptacle

MS3102R

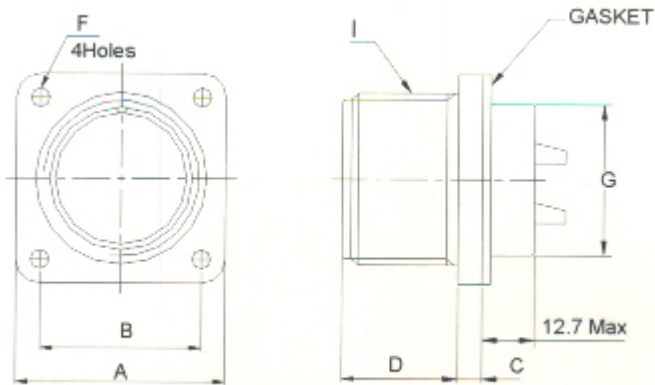

勝特力材料 886-3-5753170
 勝特力电子(上海) 86-21-54151736
 勝特力电子(深圳) 86-755-83298787
[Http://www.100y.com.tw](http://www.100y.com.tw)

MS3102R box mounting receptacles are used in junction boxes or as an integral part of equipment. These connectors are identical with 3102A in construction.

(mm)

Shell Size	± A ± 0.79	± B ± 0.12	C ± 0.3	D +0.79 -0.00	Ø F +0.25 -0.12	Ø G Max	I Thread-2A
10SL	25.40	18.26	3.0	14.28	3.05	16.0	5/8-24 UNEF
12S	27.79	20.62	3.0	14.28	3.05	16.5	3/4-20 UNEF
12	27.79	20.62	3.0	19.05	3.05	16.5	3/4-20 UNEF
14S	30.18	23.01	3.0	14.28	3.05	20.0	7/8-20 UNEF
14	30.18	23.01	3.0	19.05	3.05	20.0	7/8-20 UNEF
16S	32.54	24.61	3.0	14.28	3.05	23.0	1-20 UNEF
16	32.54	24.61	3.0	19.05	3.05	23.0	1-20 UNEF
18	34.93	26.97	4.0	19.05	3.05	26.0	1 1/8-18 UNEF
20	38.10	29.36	4.0	19.05	3.05	29.0	1 1/4-18 UNEF
22	41.28	31.75	4.0	19.05	3.05	32.0	1 3/8-18 UNEF
24	44.45	34.93	4.0	20.63	3.73	35.5	1 1/2-18 UNEF
28	50.80	39.67	4.0	20.63	3.73	42.0	1 3/4-18 UNEF
32	57.15	44.45	4.0	22.23	4.39	48.0	2-18 UNS
36	63.50	49.23	4.0	22.23	4.39	55.0	2 1/4-16 UN

MIL-C-5015 connectors

'R' class Dimension

Straight Plug

MS3106R

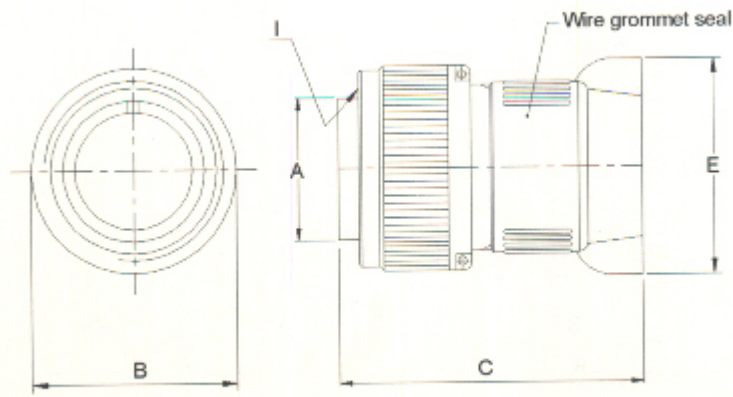

勝特力材料 886-3-5753170
 勝特力电子(上海) 86-21-54151736
 勝特力电子(深圳) 86-755-83298787
[Http://www.100y.com.tw](http://www.100y.com.tw)

MS3106R straight plugs are identical in purpose to the MS3106F.

The MS3106R has the shorter endbell.(mm)

Shell Size	A +0.00 -0.38	B MAX	C Max	Ø E Max	I Thread-2B
10SL	11.33	24.61	46.68	24.0	5/8-24 UNEF
12S	14.10	26.97	46.68	24.0	3/4-20 UNEF
12	14.10	26.97	55.39	24.0	3/4-20 UNEF
14S	17.15	29.36	46.68	27.6	7/8-20 UNEF
14	17.15	29.36	55.39	27.6	7/8-20 UNEF
16S	20.45	31.75	46.68	31.2	1-20 UNEF
16	20.45	31.75	55.39	31.2	1-20 UNEF
18	23.62	34.13	57.93	36.2	1 1/8-18 UNEF
20	26.67	37.31	57.93	39.8	1 1/4-18 UNEF
22	29.85	40.48	57.93	39.8	1 3/8-18 UNEF
24	33.02	43.66	57.93	46.0	1 1/2-18 UNEF
28	38.61	50.01	57.93	46.0	1 3/4-18 UNEF
32	44.96	56.36	57.93	53.5	2-18 UNS
36	50.29	62.71	58.97	60.0	2 1/4-16 UN

MIL-C-5015 connectors

'R' class Dimension

Right Angle Plug

MS3108R

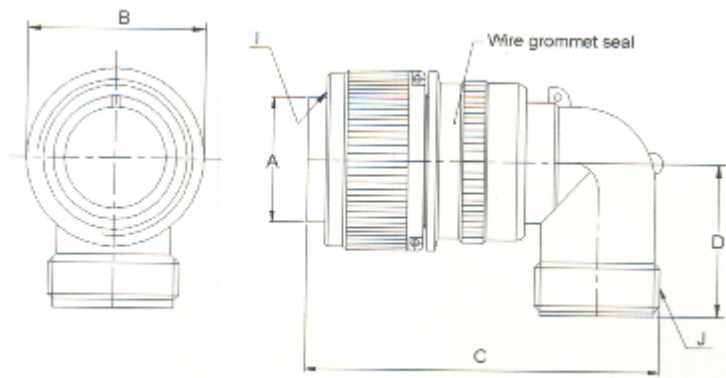

勝特力材料 886-3-5753170
 勝特力电子(上海) 86-21-54151736
 勝特力电子(深圳) 86-755-83298787
[Http://www.100y.com.tw](http://www.100y.com.tw)

MS3108R Right angle plugs are used where there is limited space and where wires must be brought at abrupt angles.

(mm)

Shell Size	ØA +0.00 -0.38	ØB +0.00 -0.38	C Max	D Max	I Thread-2B	J Thread-2A
10SL	11.33	24.61	46.02	25.4	5/8-24 UNEF	5/8-24 UNEF
12S*	14.10	26.97	50.80	26.9	3/4-20 UNEF	5/8-24 UNEF
12*	14.10	26.97	57.15	26.9	3/4-20 UNEF	5/8-24 UNEF
14S	17.15	29.36	53.97	28.5	7/8-20 UNEF	3/4-20 UNEF
14	17.15	29.36	58.72	28.5	7/8-20UNEF	3/4-20 UNEF
16S	20.45	31.75	60.32	30.1	1-20UNEF	7/8-20 UNEF
16	20.45	31.75	65.07	30.1	1-20UNEF	7/8-20 UNEF
18	23.62	34.13	68.27	33.3	1 1/8-18 UNEF	1-20UNEF
20	26.67	37.31	76.98	34.9	1 1/4-18 UNEF	1 3/16-18 UNEF
22	29.85	40.48	76.98	34.9	1 3/8-18 UNEF	1 3/16-18 UNEF
24	33.02	43.66	86.51	39.6	1 1/2-18 UNEF	1 7/16-18 UNEF
28	38.61	50.01	86.51	39.6	1 3/4-18 UNEF	1 7/16-18 UNEF
32	44.96	56.36	95.25	47.6	2-18 UNS	1 3/4-18 UNS
36	50.29	62.71	100.02	52.3	2 1/4-16 UN	2-18 UNS

MIL-C-5015 connectors

Accessories



Plug Protection Cap

These metal dust caps are used to protect the plugs and receptacles. They are furnished with sash chains and are available with bead chains.

MS3057 style cable clamp was designed for use with jacketed cable or wire protected by tubing. Both clamping halves float maximum strain relief. For unjacketed cable or wires, Use corresponding MS3420 telescoping bushing.

Telescoping bushings keep dirt, oil and moisture out of end bell.

Sealing Gasket is being supplied separately.



Receptacle Protection Cap

勝特力材料 886-3-5753170
勝特力电子(上海) 86-21-54151736
勝特力电子(深圳) 86-755-83298787
[Http://www.100y.com.tw](http://www.100y.com.tw)



Cable Clamp

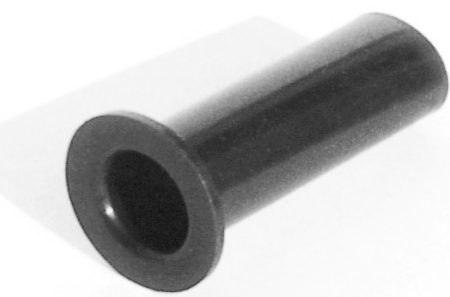

Telescoping Bushing



Sealing Gasket

MIL-C-5015 connectors

Accessories Dimension

Plug Protection Cap

MS25042

勝特力材料 886-3-5753170
 勝特力电子(上海) 86-21-54151736
 勝特力电子(深圳) 86-755-83298787
[Http://www.100y.com.tw](http://www.100y.com.tw)

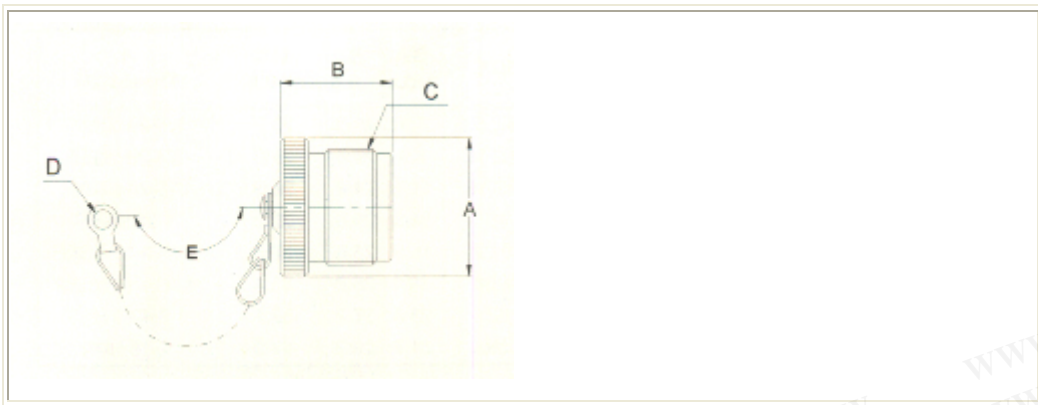

PART NUMBER	SIZE	ØA Max	B Max	C Thread 2A	ØD -0.3	E Approx
MS25042-10D	10S,10SL	18.5	17.2	5/8-24 UNEF	4.2	102
MS25042-12D	12S,12	20.4	21.4	3/4-20 UNEF	4.2	114
MS25042-14D	14S,14	23.6	21.4	7/8-20 UNEF	4.2	114
MS25042-16D	16S,16	26	21.4	1-20 UNEF	4.2	114
MS25042-18D	18	29.9	21.4	1 1/8-18 UNEF	4.2	114
MS25042-20D	20	33.1	21.4	1 1/4-18 UNEF	4.2*	127
MS25042-22D	22	36.2	21.4	1 3/8-18 UNEF	4.2*	127
MS25042-24D	24	39.4	21.4	1 1/2-18 UNEF	4.2*	140
MS25042-28D	28	45.7	21.4	1 3/4-18 UNEF	4.2*	197
MS25042-32D	32	52	21.4	2-18 UNS	4.2**	197
MS25042-36D	36	59	21.4	2 1/4-16 UN	4.2**	197

These externally threaded metal dust caps are used to protect the MS3106 and MS3108 plugs.

Material is aluminum alloy. They are furnished with sash chains and are available with bead chains.

Optional termination holes are also available. (*5.0)(**5.8)

Receptacle Protection Cap

MS25043

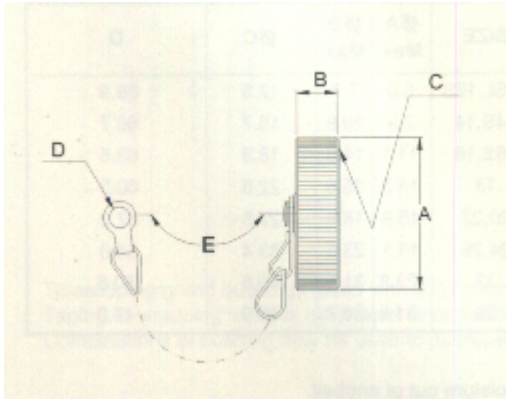

勝特力材料 886-3-5753170
 勝特力电子(上海) 86-21-54151736
 勝特力电子(深圳) 86-755-83298787
[Http://www.100y.com.tw](http://www.100y.com.tw)

PART NUMBER	SIZE	ØA Max	B Max	C Thread 2A	ØD -0.3	E Approx
MS25043-10D	10S,10SL	20.2	15.8	5/8-24 UNEF	4.2	102
MS25043-12D	12S,12	23.4	15.8	3/4-20 UNEF	4.2	114
MS25043-14D	14S,14	27.9	15.8	7/8-20 UNEF	4.2	114
MS25043-16D	16S,16	29.8	15.8	1-20 UNEF	4.2	114
MS25043-18D	18	32.2	15.8	1 1/8-18 UNEF	4.2	114
MS25043-20D	20	36.3	15.8	1 1/4-18 UNEF	4.2	127
MS25043-22D	22	39.9	15.8	1 3/8-18 UNEF	4.2	127
MS25043-24D	24	43.7	15.8	1 1/2-18 UNEF	4.2*	140
MS25043-28D	28	50	15.8	1 3/4-18 UNS	4.2*	197
MS25043-32D	32	56.5	15.8	2-18 UNS	4.2**	197
MS25043-36D	36	61.5	15.8	2 1/4-16 UN	4.2**	197

These internally threaded metal dust caps are used to protect MS3100, MS3101 and MS3102 receptacles.

Metal Is aluminum alloy. They are furnished with sash chains and are available with bead chains.

Optional termination holes are also available.(*4.58)(**5.00)

MIL-C-5015 connectors

Accessories Dimension

Cable Clamp

MS3057

勝特力材料 886-3-5753170
 勝特力电子(上海) 86-21-54151736
 勝特力电子(深圳) 86-755-83298787
 Http://www.100y.com.tw

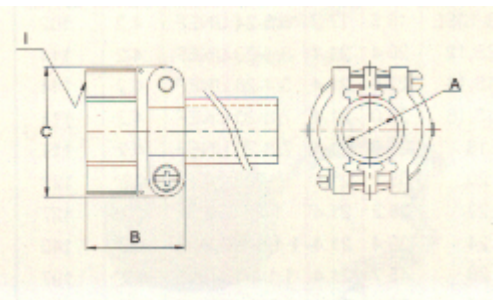

PART NUMBER	SIZE	ØA ±0.4	B ±0.8	ØC ±0.8	I Thread-2B
MS3057-4A	10SL,12S	5.6	20.3	23.3	5/8-24 UNEF
MS3057-6A	14S,14	7.9	22.5	25.9	3/4-20 UNEF
MS3057-8A	16S,16	11.1	24.4	28.9	7/8-20 UNEF
MS3057-10A	18	14.3	23.6	32.2	1-20 UNEF
MS3057-12A	20,22	15.9	23.6	37.8	1 3/16-18 UNEF
MS3057-16A	24,28	19.1	26.0	43.4	1 7/16-18 UNEF
MS3057-20A	32	23.8	27.7	52.1	1 3/4-18 UNS
MS3057-24A	36	31.8	29.2	57.3	2-18 UNS

MS3057 style cable clamp was designed for use with jacketed cable or wire protected by tubing.

Both clamping halves float maximum strain relief. for unjacketed cable or wires, use corresponding

MS3420 telescoping bushing. To order clamp without bushing, add -1 to the P/N.

Telescoping Bushing

MS3420

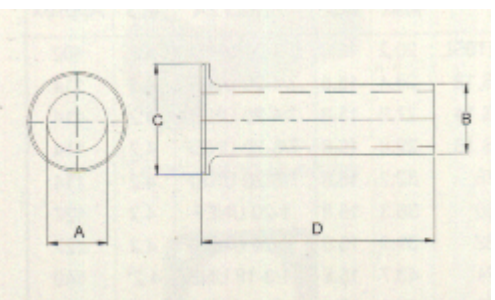

PART NUMBER	SIZE	ØA Max	ØB Max	ØC	D
MS3420-4	10SL,12S	5.6	7.7	12.8	69.9
MS3420-6	14S,14	7.9	10.9	15.7	66.7
MS3420-8	16S,16	11.1	14.0	18.9	63.5
MS3420-10	18	14.3	15.6	22.6	60.3
MS3420-12	20,22	15.9	18.8	27.5	57.2
MS3420-16	24,28	19.1	23.6	33.4	54.0
MS3420-20	32	23.8	31.5	40.6	50.8
MS3420-24	36	31.8	34.7	46.9	47.6

Telescoping grand bushings (used with 3057 clamp) keep dirt, oil and moisture out of endbell.

Taping or wrapping wires is eliminated since bushing protects wires going thru clamp.

Combinations of bushing may be used to decrease cable entry diameter to improve sealing.

MIL-C-5015 connectors

Accessories Dimension

Cable Clamp

DL3057

PART NUMBER	SIZE	ØA	B	ØC	D	I Thread - 2B
DL3057-4A	10SL	6.0	20.3	23.3	53.3	5/8-24 UNEF
DL3057-10A	18	14.0	23.6	32.2	54.4	1-20 UNEF
DL3057-12A	20, 22	15.9	23.6	37.8	57.3	1 3/16-18 UNEF
DL3057-16A	24	18.0	26.0	43.4	56.4	1 7/16-18 UNEF

DL3057 style cable clamp was designed for use with jacketed cable or wire protected by tubing.

Both clamping halves float maximum strain relief. for unjacketed cable or wires, use corresponding DL3420 telescoping bushing. To order clamp without busing, add -1 to the P/N.

勝特力材料 886-3-5753170
勝特力电子(上海) 86-21-54151736
勝特力电子(深圳) 86-755-83298787
[Http://www.100y.com.tw](http://www.100y.com.tw)

Telescoping Bushing

DL3420

PART NUMBER	SIZE	ØA Max	ØB Max	ØC	D
DL3420-4	10SL	6.0	7.7	12.0	47.5
DL3420-10	18	14.0	15.6	20.7	52.2
DL3420-12	20,22	15.9	18.8	24.5	52.3
DL3420-16	24	18.0	23.6	30.0	56.0

Telescoping grand bushings (used with 3057 clamp) keep dirt, oil and moisture out of endbell.

Taping or wrapping wires is eliminated since bushing protects wires going thru clamp.

Combinations of bushing may be used to decrease cable entry diameter to improve sealing.

MIL-C-5015 connectors

Accessories Dimension

Sealing Gasket

BMA 31

PART NUMBER	Shell Size	±A	±B	ØC	D +0.2
BMA31-10	10S,10SL	25.40	18.26	14.9	3.2
BMA31-12	12S,12	27.79	20.62	16.4	3.2
BMA31-14	14S,14	30.18	23.01	20.4	3.2
BMA31-16	16S,16	32.54	24.61	23.0	3.2
BMA31-18	18	34.94	26.97	25.9	3.2
BMA31-20	20	38.10	29.36	29.1	3.2
BMA31-22	22	41.28	31.75	32.0	3.2
BMA31-24	24	44.45	34.93	35.3	3.8
BMA31-28	28	50.80	39.67	41.5	3.8

BMA31-32	32	57.15	44.45	47.5	4.6
BMA31-36	36	63.50	49.23	54.7	4.6

The flat gasket of synthetic rubber material is provided to take complete advantage of waterproof and pressure sealing features. It is use with the flange mounted receptacle.

勝特力材料 886-3-5753170
 勝特力电子(上海) 86-21-54151736
 勝特力电子(深圳) 86-755-83298787
[Http://www.100y.com.tw](http://www.100y.com.tw)

Panel Mounting Hole(Reference)

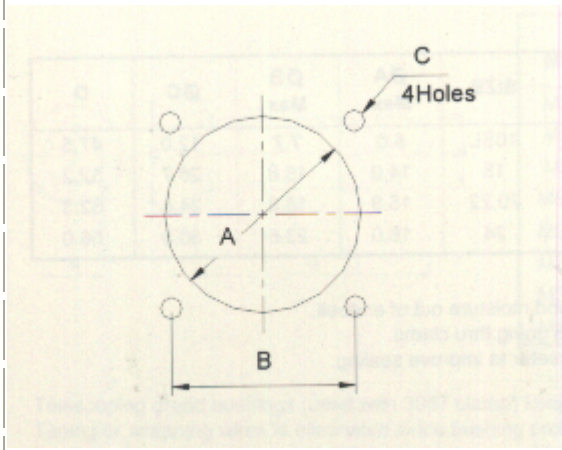

Shell Size	ØA ± 0.5	∓B ± 0.12	C +0.2
10SL	17.5	18.26	3.2
12S	18.5	20.62	3.2
12	18.5	20.62	3.2
14S	22.0	23.01	3.2
14	22.0	23.01	3.2
16S	25.0	24.61	3.2
16	25.0	24.61	3.2
18	30.0	26.97	3.2
20	33.0	29.36	3.2
22	35.0	31.75	3.2
24	39.0	34.93	3.8
28	45.0	39.67	3.8
32	52.0	44.45	4.6
36	59.0	49.23	4.6

勝特力材料 886-3-5753170
 勝特力电子(上海) 86-21-54151736
 勝特力电子(深圳) 86-755-83298787
 Http://www.100y.com.tw

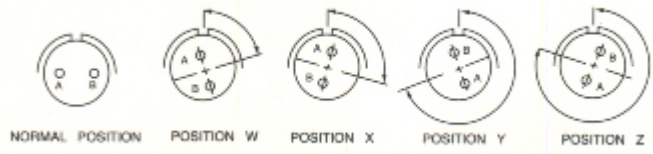

Contact Arrange-ment	Service Rating	Total Cont-acts	Contact Size					Alternate Position-Degrees			
			0	4	8	12	16	W	X	Y	Z
10S-2	A	1					1	-	-	-	-
10SL-3	A	3					3	-	-	-	-
10SL-4	A	2					2	-	-	-	-
12S-1	A	2					2	-	-	-	-
12S-3	A	2					2	4	145	215	290
12S-4	D	1					1	-	-	-	-
12-5	D	1				1		-	-	-	-
14S-1	A	3					3	-	-	-	-
14S-2	INST	4					4	-	120	240	-
14S-4	D	1					1				
14S-5	INST	5					5	-	110	-	-
14S-6	INST	6					6	-	-	-	-
14S-7	A	3					3	90	180	270	-
14S-9	A	2					2	70	145	215	290
14S-10	INST	4					4	-	-	-	-
14S-12	A	3					3	-	-	-	-
14-3	A	1			1			-	-	-	-
16S-1	A	7					7	80	-	-	280
16S-3	B	1					1	-	-	-	-
16S-4	D	2					2	35	110	250	325
16S-5	A	3					3	70	145	215	290
16S-6	A	3					3	90	180	270	-
16S-8	A	5					5	-	170	265	-
16-2	E	1				1		-	-	-	-
16-7	A	3			1		2		-	-	
16-9	A	4				2	2	35	110	250	325
16-10	A	3				3		90	180	270	-
16-11	A	2				2		35	110	250	325
16-12	A	1			1			-	-	-	-
16-13	A	2				2		35	110	250	325
18-1	A/Inst	10					10	70	145	215	290
18-3	D	2				2		35	110	250	325
18-4	D	4					4	35	110	250	325

Contact Arrange-ment	Service Rating	Total Cont-acts	Contact Size					Alternate Position-Degrees			
			0	4	8	12	16	W	X	Y	Z
18-22	D	3					3	70	145	215	290
18-24	A/Inst	10					10	-	-	-	-
18-29	A	5					5	-	-	-	-
18-30	A	5					5	-	-	-	-
18-31	A	5					5	-	-	-	-
20-2	D	1	1					-	-	-	-
20-3	D	3				3		40	145	215	290
20-4	D	4				4		45	110	250	-
20-6	D	3					3				
20-7	D/A	8					8	80	110	250	280
20-8	Inst.	6			2		4	80	110	250	280
20-9	D/A	8				1	7				
20-11	Inst.	13					12	-	-	-	-
20-12	A	2		1			1	-	-	-	-
20-14	A	5			2	3		-	-	-	-
20-15	A	7				7		80	-	-	280
20-16	A	9				2	7	80	110	250	280
20-17	A	6				5	1	90	180	270	-
20-18	A	9				3	6	35	110	250	325
20-19	A	3				3		90	180	270	-
20-20	A	4		1		3		-	-	-	-
20-21	A	9				1	8	-	-	-	-
20-22	A	6			3		3	80	110	250	280
20-23	A	2			2			35	110	250	325
20-24	A	4			2		2	-	-	-	-
20-25	Inst.	13					13	-	-	-	-
20-27	A	14					14	35	110	250	325
20-29	A	17					17	80	-	-	20
20-30	Inst.	13					13	-	-	-	-
20-33	A	11					11	-	-	-	-
22-1	D	2			2			35	110	250	325
22-2	D	3			3			70	145	215	290
22-4	A	4			2	2		35	110	250	325

18-5	D	3			2	1	80	110	250	280
18-6	D	1	1				-	-	-	-
18-7	B	1		1			-	-	-	-
18-8	A	8			1	7	70	-	-	290
18-9	Inst.	7			2	5	80	110	250	280
18-10	A	4			4		-	120	240	-
18-11	A	5			5		-	170	265	
18-12	A	6				6	80	-	-	280
18-13	A	4		1	3		80	110	250	280
18-14	A	2	1		1		-	-	-	-
18-15	A	4			4		-	120	240	-
18-16	C	1			1		-	-	-	-
18-17	Inst.	7			2	5	-	-	-	-
18-19	A	10				10	-	120	240	-
18-20	A	5				5	90	180	270	-
18-21	A1	3			3		-	-	-	-

22-5	D	6				2	4	-	-	-	-
22-6	D	3			2		1	-	-	-	-
22-7	E	1	1					-	-	-	-
22-8	E	2				2		35	110	250	325
22-9	E	3				3		70	145	215	290
22-10	E	4					4	35	110	250	325
22-11	B	2					2	35	110	250	325
22-12	D	5			2		3	80	110	250	280
22-13	D/A	5				4	1	34	110	250	325
22-14	A	19					19	80	110	250	280
22-15	E/A	6				5	1	80	110	250	280
22-16	A	9				3	6	-	-	-	-
22-17	D/A	9				1	8	-	-	-	-
22-18	A/D	8					8	80	110	250	280
22-19	A	14					14	80	110	250	280
22-20	A	9					9	35	110	250	325

MIL-C-5015 Connectors

MS/DS Series

Insert Arrangement & Alternate Positioning

勝特力材料 886-3-5753170
 勝特力电子(上海) 86-21-54151736
 勝特力电子(深圳) 86-755-83298787
[Http://www.100y.com.tw](http://www.100y.com.tw)

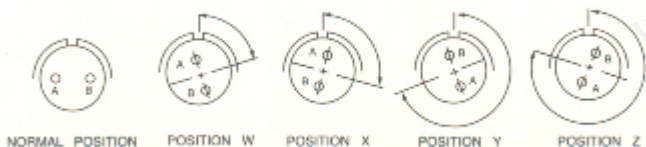

Contact Arrange-ment	Service Rating	Total Cont-acts	Contact Size					Alternate Position-Degrees			
			0	4	8	12	16	W	X	Y	Z
22-21	A	3					2	-	-	-	-
22-22	A	4			4			-	110	250	-
22-23	D/A	8				8		35	-	250	-
22-27	D/A	6				2	4	80	-	250	280
22-28	A	9			1		8	80	-	-	280
22-33	D/A	7					7	-	-	-	-
22-34	D	5				3	2	-	-	-	-
24-2	D	7				7		80	-	-	280
24-3	D	7				2	5	-	-	-	-
24-5	A	16					16	80	110	250	280
24-6	D/A	8				8		80	110	250	280
24-7	A	16				2	14	80	110	250	280
24-9	A	2	2					35	110	250	325
24-10	A	7			7			80	-	-	280
24-11	A	9			3	6		35	110	250	325

Contact Arrange-ment	Service Rating	Total Cont-acts	Contact Size					Alternate Position-Degrees			
			0	4	8	12	16	W	X	Y	Z
28-19	B/D/A	10			4	6		80	110	250	280
28-20	A	14			10	4		80	110	250	280
28-21	A	37				37		80	110	250	280
28-22	D	6	3			3		70	145	215	290
32-1	E/D	5	2			3		80	110	250	280
32-2	E	5		3			2	-	-	-	-
32-3	D	9	1	2		2	4	-	-	-	-
32-4	A/D	14				2	12	-	-	-	-
32-5	D	2	2					35	110	250	325
32-6	A	23		2	3	2	16	80	110	250	325
32-7	INST/A	35				7	28	80	125	235	280
32-8	A	30				6	24	80	125	235	280
32-9	D	14		2			12	80	110	250	280
32-10	E/B/D/A	7		2	2		3	-	-	-	-
32-12	A/D	15				5	10	-	-	-	-

24-12	A	5		2	3		80	110	250	280
24-16	D/A	7			1	3	3	-	-	-
24-17	D	5			2	3	-	-	-	-
24-20	D	11			2	9	80	110	250	280
24-21	D	10		1		9	-	-	-	-
24-22	D	4		4			45	110	250	-
24-27	E	7				7	-	-	-	-
24-28	INST	24				24	80	110	250	280
28-1	D/A	9		3	6		80	110	250	280
28-2	D	14			2	12	-	-	-	-
28-3	E	3		3			70	145	215	290
28-4	E/D	9			2	7	-	-	-	-
28-5	D	5	2		1	2	-	-	-	-
28-6	D	3	3				70	145	215	290
28-7	D	2	2				35	110	250	325
28-8	E/D/A	12			2	10				
28-9	D	12			6	6	80	110	250	280
28-10	D/A	7	2	2	3		80	110	250	280
28-11	A	22			4	18	80	110	250	280
28-12	A	26				26	90	180	270	
28-13	A	26				26	-	-	-	-
28-15	A	35				35	80	110	250	280
28-16	A	20				20	80	110	250	280
28-17	B/D/A	15				15	-	-	-	-
28-18	C/D/A/Inst.	12				12	-	-	-	-

32-13	D	23				5	18	-	-	-	-
32-15	D	8	2			6		35	110	250	280
32-16	A	23		2	3	2	16	-	-	-	-
32-17	D	4		4				45	110	250	280
32-22	A/U/V	54					54	80	110	250	280
36-1	D	22				4	18	80	110	250	280
36-3	D	6	3			3		70	145	215	290
36-4	D/A	3	3					70	145	215	290
36-5	A	4	4					-	120	240	-
36-6	A	6	2	4				35	110	250	325
36-7	A	47				7	40	80	110	250	280
36-8	A	47				1	46	80	110	250	280
36-9	A	31		1	2	14	14	80	125	235	280
36-10	A	48					48	80	125	235	280
36-11	A	48					48	-	-	-	-
36-12	A	48					48	-	-	-	-
36-13	E/A	17				2	15	80	110	250	280
36-14	D	16				5	5	6	90	180	270
36-15	D/A	35					35	60	125	245	305
36-16	A	47				7	40	-	-	-	-
36-17	A	47				7	40	-	-	-	-
36-18	A	31		1	2	14	14	-	-	-	-
36-20	A	34			2	2	30	-	-	-	-
36-52	A	52					52	72	144	216	288

MIL-C-5015 Connectors

MS/DS Series

Contact Arrangement

勝特力材料 886-3-5753170
 勝特力电子(上海) 86-21-54151736
 勝特力电子(深圳) 86-755-83298787
[Http://www.100y.com.tw](http://www.100y.com.tw)

1 CONTACT

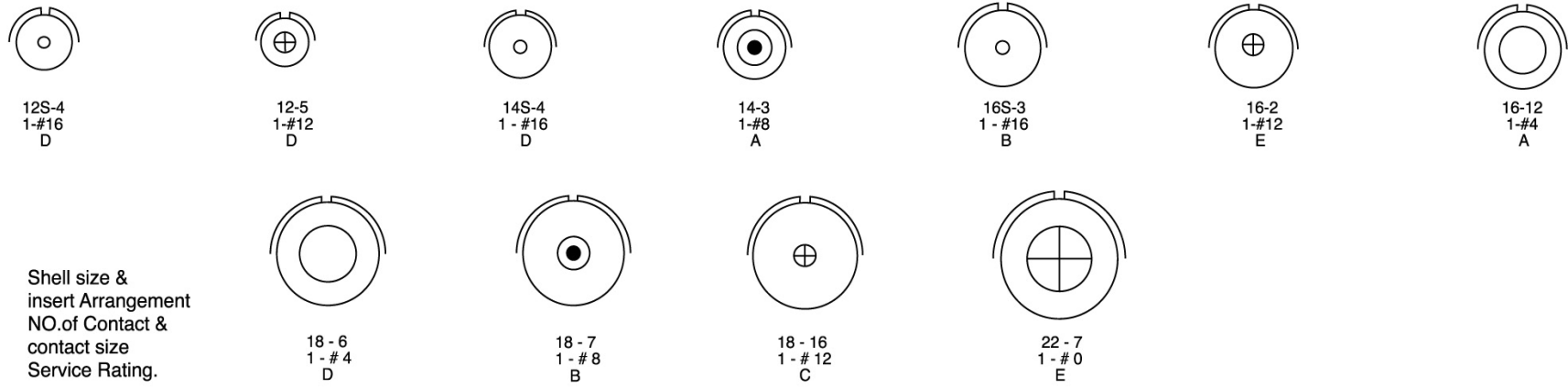

2 CONTACTS

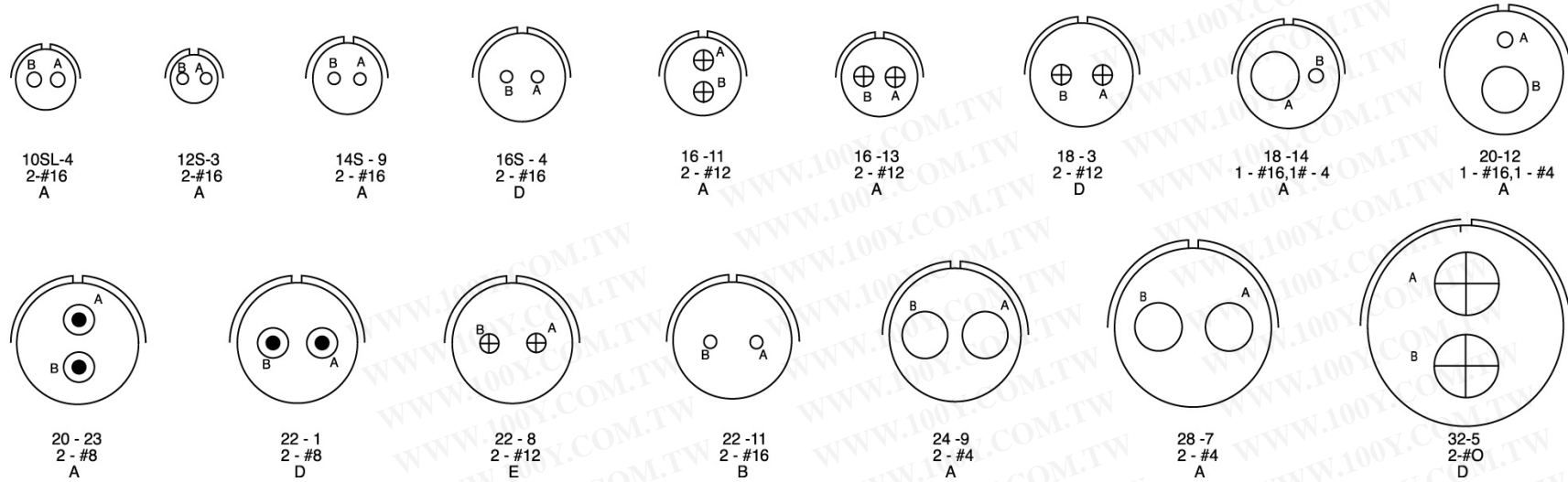

3 CONTACTS

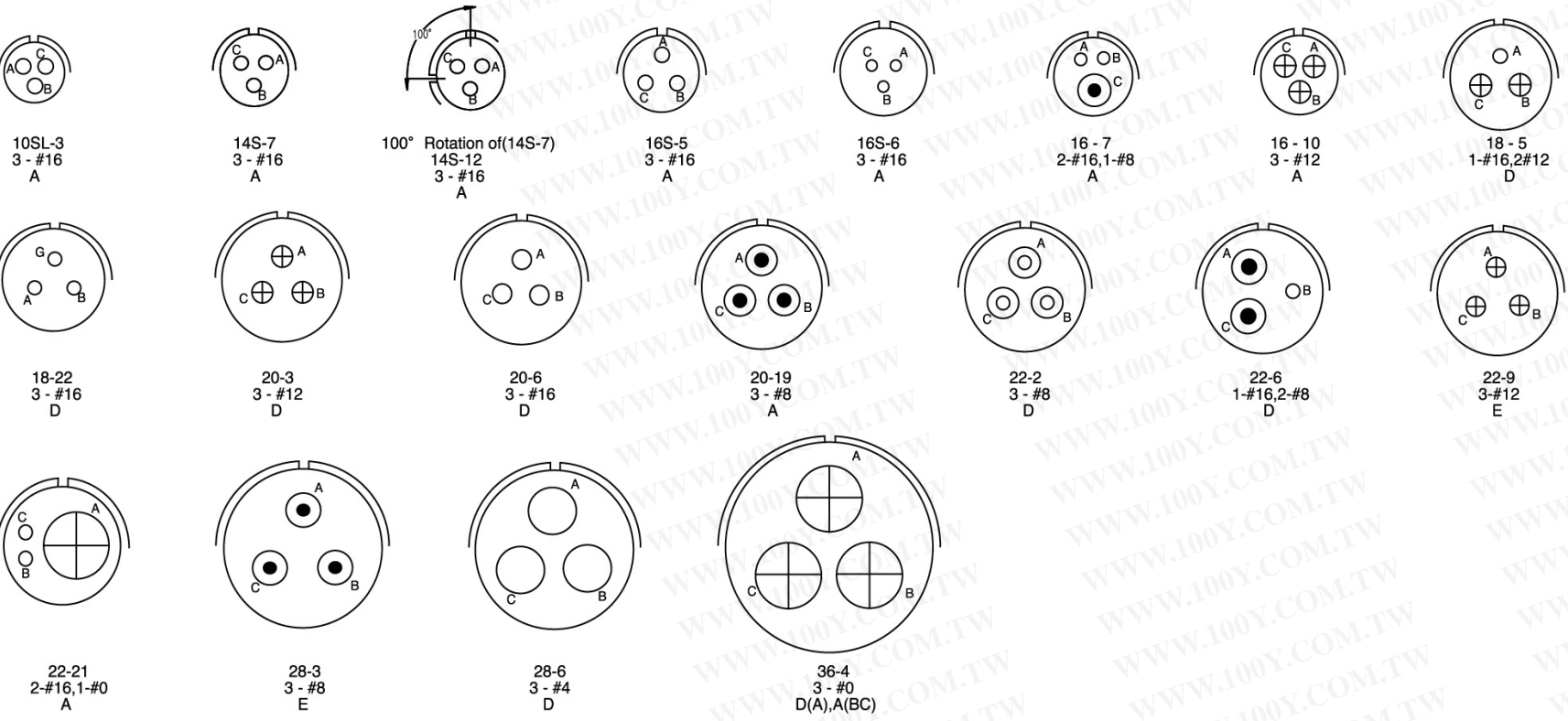

MIL-C-5015 Connectors

MS/DS Series

Contact Arrangement

勝特力材料 886-3-5753170
 勝特力电子(上海) 86-21-54151736
 勝特力电子(深圳) 86-755-83298787
[Http://www.100y.com.tw](http://www.100y.com.tw)

4 CONTACTS

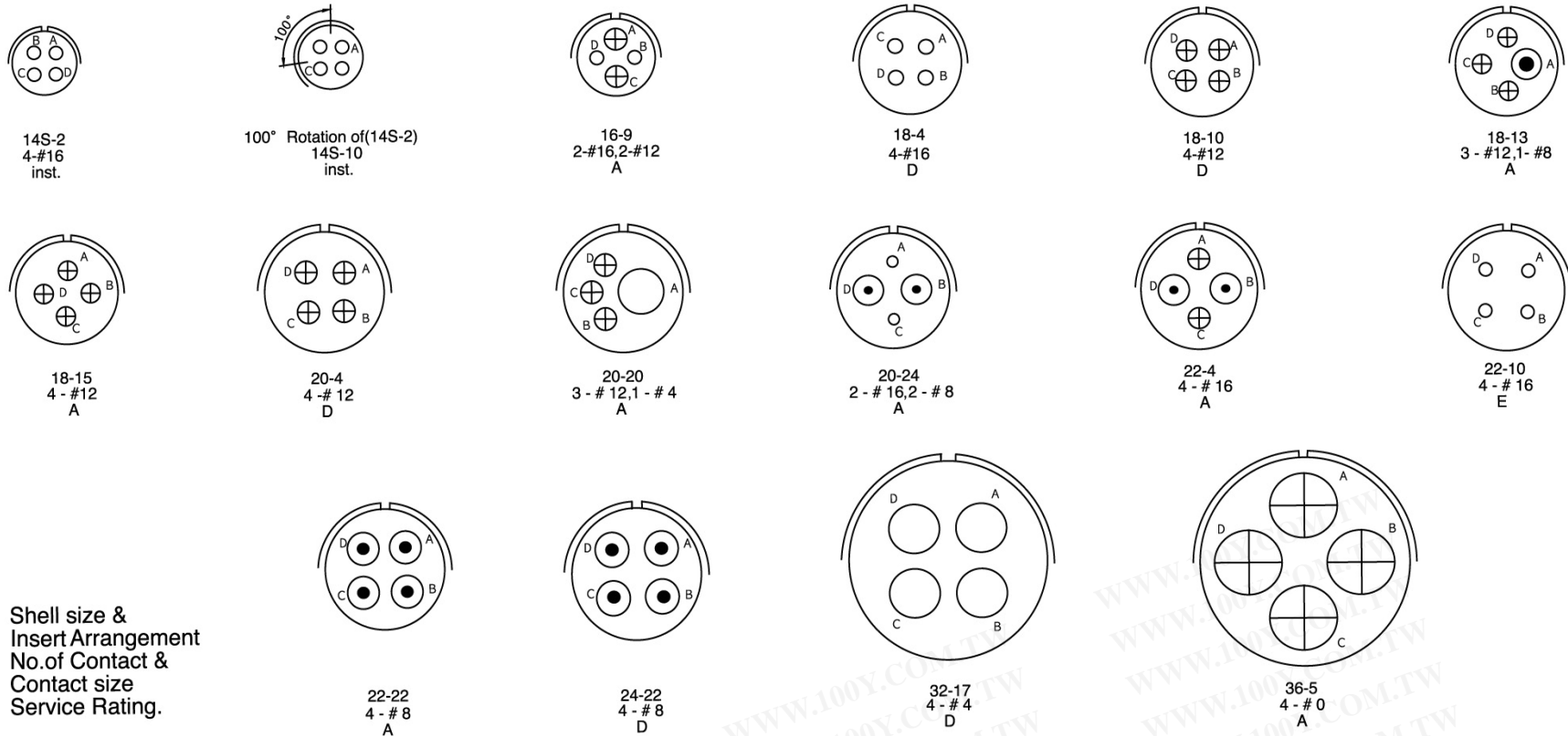

5 CONTACTS

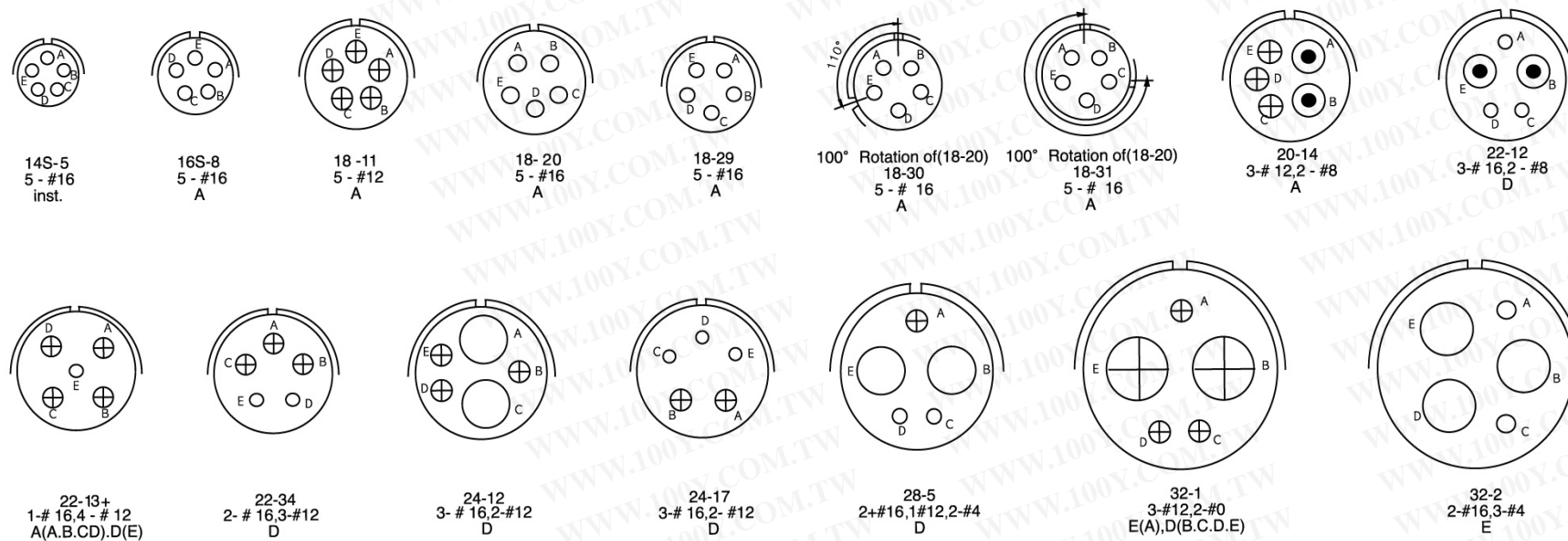

6 CONTACTS

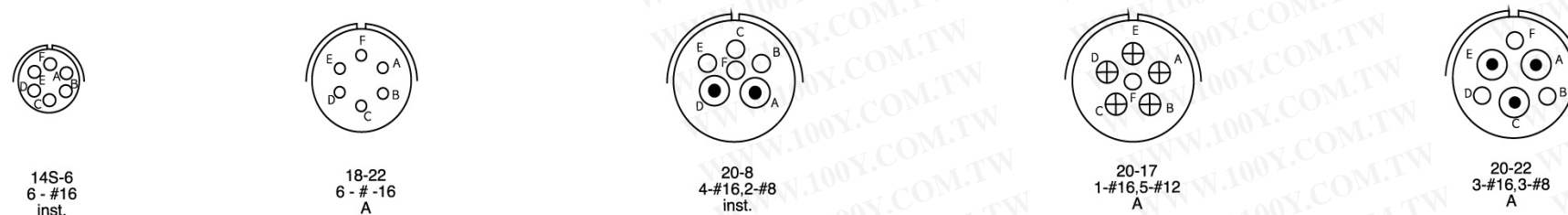

MIL-C-5015 Connectors

MS/DS Series

Contact Arrangement

勝特力材料 886-3-5753170
 勝特力电子(上海) 86-21-54151736
 勝特力电子(深圳) 86-755-83298787
[Http://www.100y.com.tw](http://www.100y.com.tw)

Shell size &
Insert Arrangement
No. of Contact &
Contact size
Service Rating

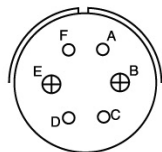

22-5
4 - #16,2-#12
D

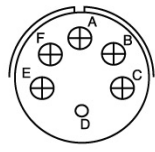

22-15
1-#16,5-#12
A(A,B,C,E,F),E(D)

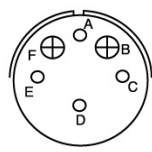

22-24
4-#16,5-#12
A(A,B,F),D(C,D,E)

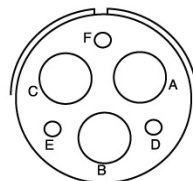

28-22
3-#16,3-#4
D

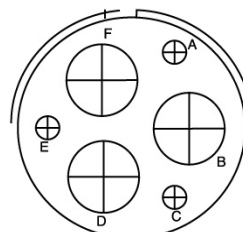

36-3
3-#12,3-#0
D

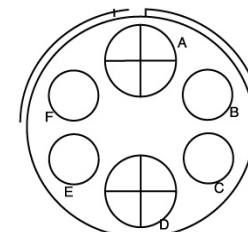

36-3
4-#4,2-#0
A

7 CONTACTS

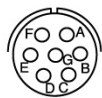

16S-1
7-#16
A

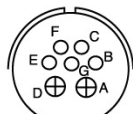

18-9
5-#16,2-12
inst.

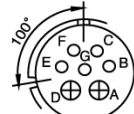

100° Rotation of (18-9)
18-17
5 - # 16,2 - #12
Inst.

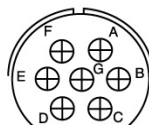

20-15
7-#12
A

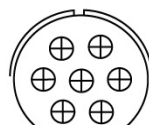

22-28
7-#12
A



22-33
7-#16
D(A~D),A(E~G)

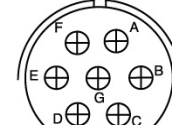

24-2
7-#12
D

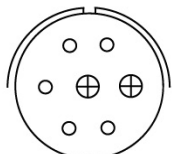

24-3
5-#16,2-#12
D

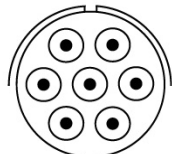

24-10
7-#8
A

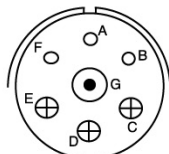

24-16
3-#16,3-#12,1-#8
D(A,B,G)A(C,D,E)

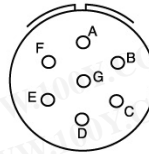

24-27
7-#16
E

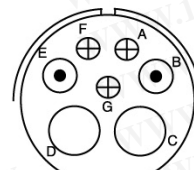

28-10
3-#12,2-#8,2-#4
D(G)BAL=A

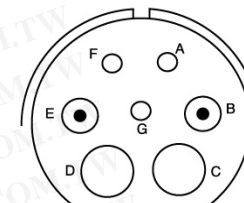

32-10
3-#16,2-#8,2-#4
E(A,F),A(C,D),D(B,E)

8 CONTACTS

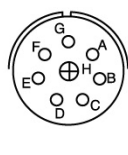

18-8
7-#16,1-#12
A

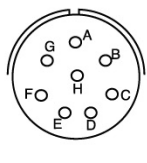

20-7
8-#16
D(A,B,G,H)A(C,D,E,F)

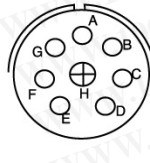

20-9
7-#16,1-#12
BAL=A



22-18
8-#16
D(A,B,F,G,H),A(C,D,E)

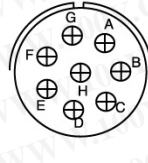

22-23
8-#16
D(H),BAL=A

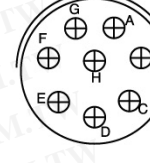

24-6
8-#12
D(A,G,H)BAL=A

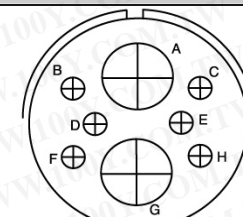

32-15
6-#12,2-#0
D

9 CONTACTS

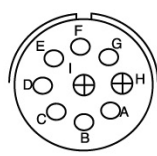

20-16
7-#16,1-#12
A

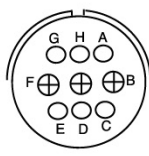

20-18
6-#16,3-#12
A

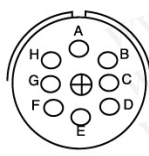

20-21
B-#16,1-#12
A

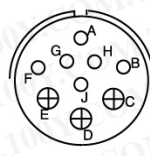

22-16
6-#16,3-#12
A

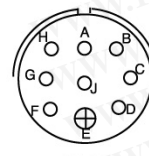

22-17
8-#16,1-#12
D(A),BAL=A

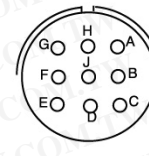

22-20
9-#16
A

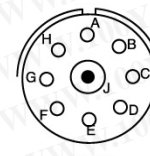

22-27
8-#16,1-#8
D(J),BAL=A

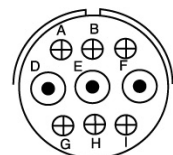

24-11
6-#12,3-#8
A

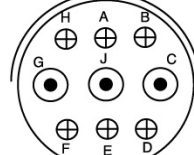

28-1
6-#12,3-#8
D(A,J,E),BAL=A

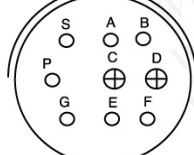

28-4
7-#16,2-#12
E(G,P,S),BAL=D

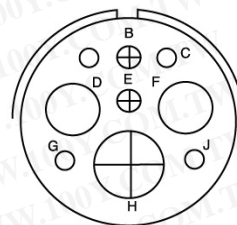

32-3
4-#16,2-#4,2-#12,1-#0
D

MIL-C-5015 Connectors

MS/DS Series

Contact Arrangement

勝特力材料 886-3-5753170
勝特力电子(上海) 86-21-54151736
勝特力电子(深圳) 86-755-83298787
[Http://www.100y.com.tw](http://www.100y.com.tw)

10 CONTACTS

Shell size &
Insert Arrangement
No. of Contact &
Contact size
Service Rating.

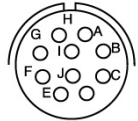

18-19
10-#16
A.B.C.G=Inst..BAL.



18-19
10-#16
A

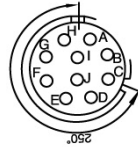

250° Rotation of(18-1)
18-24
10-#16
A(B.C.F.G)Inst..BAL.

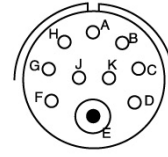

24-21
9-#16,1-#8
D

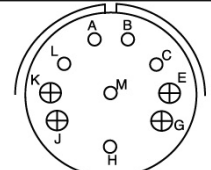

28-19
6-#16,4-#12
B(H.M),D,B,BAL.=A

11 CONTACTS

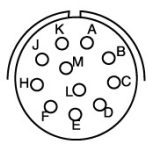

20-33
11-#16
A

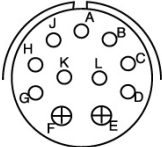

24-20
9-#16,2-#12
D

12 CONTACTS

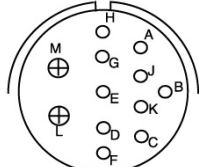

28-8
10-#16,2-#12
E(L.M), D.B,BAL.=A

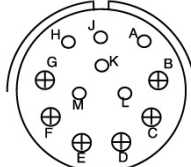

28-9
6-#16,6-#12
D

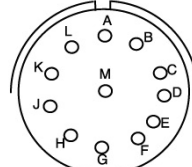

28-18
12-#16
C.M.D(G.H.J.K.L),A(A.B)=Inst..BAL.

13 CONTACTS

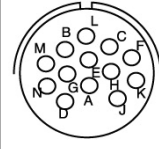

20-11
13-#16
Inst.

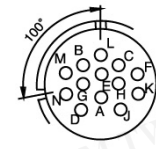

100° Rotation of(20-11)
20-25
13-#16
Inst.

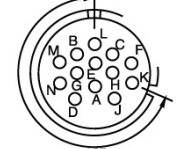

250° Rotation of(20-11)
20-30
13-#16
Inst.

14 CONTACTS



20-27
14-#16
A

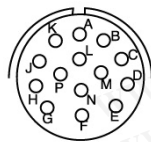

22-19
14-#16
A

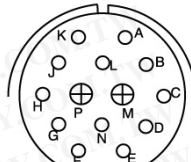

28-20
12-#16,10-#12
D

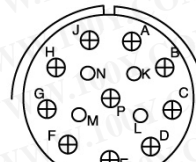

28-20
4-#16,10-#12
A

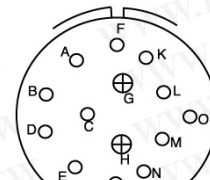

32-4
12-#16,2-#12
A.F(J.K.N),D.B,BAL.=D

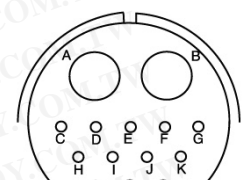

32-9
12-#16,2-#4
D

15 CONTACTS

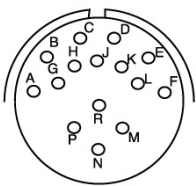

28-17
15-#16
B(R),O(M.N.P),A(A-L)

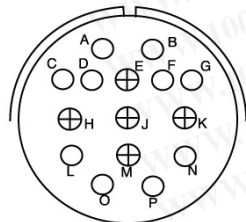

32-12
10-#16,5-#12
A(C.D.E.F.G)BAL.=D

16 CONTACTS

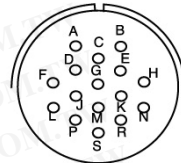

24-5
16-#16
A

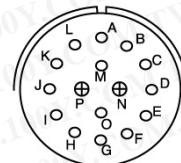

24-7
4-#16,2-#12
A

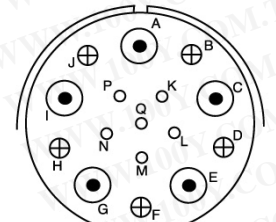

36-14
6-#16,5-#8,5-#12
D

17 CONTACTS



20-29
17-#16
A

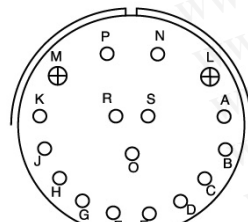

36-13
15-#16,2-#12
E(N.P.O), BAL.=A

19 CONTACTS



22-14
19-#16
A

20 CONTACTS

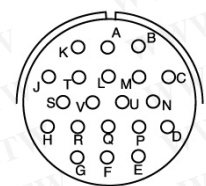

28-16
20-#16
A

MIL-C-5015 Connectors

MS/DS Series

Contact Arrangement

勝特力材料 886-3-5753170
勝特力电子(上海) 86-21-54151736
勝特力电子(深圳) 86-755-83298787
[Http://www.100y.com.tw](http://www.100y.com.tw)

22 CONTACTS

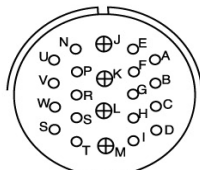

Shell size &
Insert Arrangement
No. of Contact &
Contact size
Service Rating.

28-11
18-#16,4-#12
A

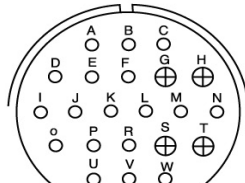

36-1
18-#16,4-#12
D

23 CONTACTS

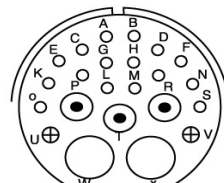

32-6
16-#16,3-#8,2-#12,2-#4
A

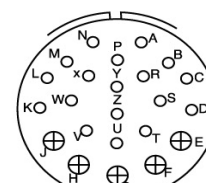

32-13
18-#16,5-#12
D

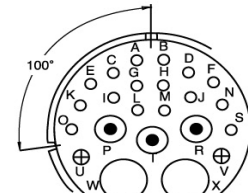

100° Rotation of(32-6)
32-16
16 - # 16,3-#8,2-#12,2-#4
A

24 CONTACTS



24-28
24 - # 16
Inst.

26 CONTACTS

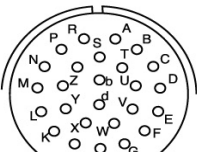

28-12
26 - # 16
A

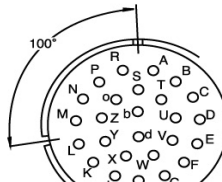

100° Rotation of(28-12)
28-13
26 - #16
A

30 CONTACTS

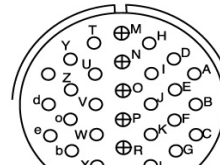

32-8
24-#16,6-#12
A

31 CONTACTS

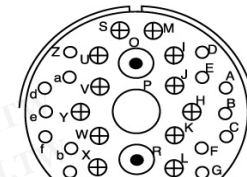

36-9
14-#16,2-#8,14-#12,1-#4
A

31 CONTACTS

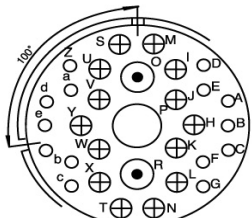

100° Rotation of(36-9)
36-18
14-#16,2-#8,14-#12,1-#4
A

34 CONTACTS

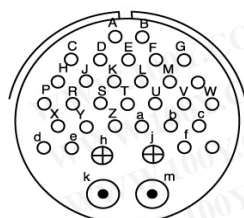

36-20
30-#16,2-#12,2-#8
A

35 CONTACTS

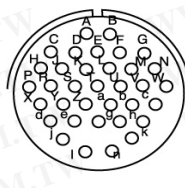

28-15
35-#16
A

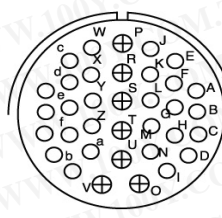

32-7
28-#16,7-#12
a.b.h.j=Inst.,BAL.=A

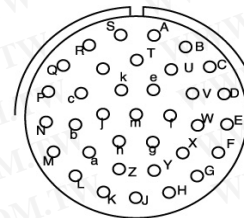

36-15
35-#16
D(M).BAL.=A

37 CONTACTS

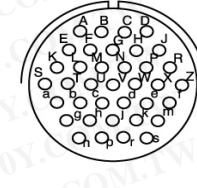

28-21
37-#16
A

47 CONTACTS

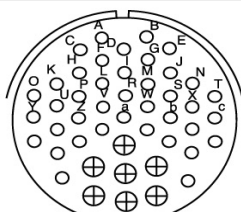

36-7
40 - # 16,7-#12
A

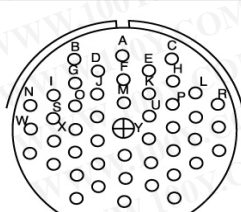

36-8
46 - # 16,1-#12
A

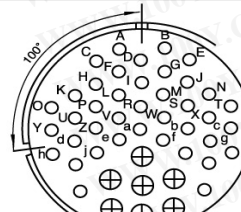

100° Rotation of(36-7)
36-16
40 - # 16,7-#12
A

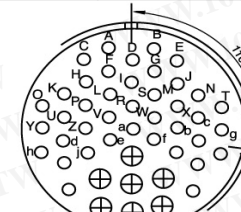

110° Rotation of(36-7)
36-17
40 - # 16,7-#12
A

48 CONTACTS

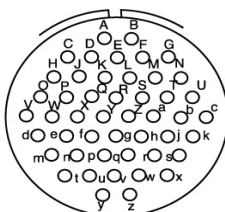

36-10
48 - # 16
A

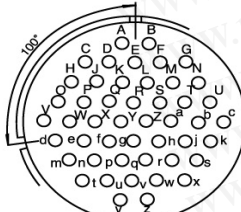

100° Rotation of(36-10)
36-11
48 - # 16
A

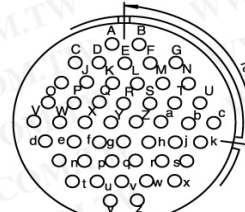

100° Rotation of(36-10)
36-12
48 - # 16
A

52 CONTACTS

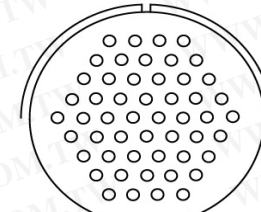

36-52
52 - # 16
A

勝特力材料 886-3-5753170
勝特力电子(上海) 86-21-54151736
勝特力电子(深圳) 86-755-83298787
[Http://www.100y.com.tw](http://www.100y.com.tw)