

MPC100

Wide Bandwidth 4 x 1 VIDEO MULTIPLEXER

FEATURES

- **BANDWIDTH: 250MHz (1.4Vp-p)**
- **LOW INTERCHANNEL CROSSTALK:**
 $\leq 60\text{dB}$ (30MHz, DIP); $\leq 70\text{dB}$ (30MHz, SO)
- **LOW SWITCHING TRANSIENTS:**
 $+2.5/-1.2\text{mV}$
- **LOW DIFFERENTIAL GAIN/PHASE ERRORS: 0.05%, 0.01°**
- **LOW QUIESCENT CURRENT:**
 One Channel Selected: $\pm 4.6\text{mA}$
 No Channel Selected: $\pm 230\mu\text{A}$

APPLICATIONS

- VIDEO ROUTING AND MULTIPLEXING (CROSSPOINTS)
- RADAR SYSTEMS
- DATA ACQUISITION
- INFORMATION TERMINALS
- SATELLITE OR RADIO LINK IF ROUTING

DESCRIPTION

The MPC100 is a very wide bandwidth 4-to-1 channel video signal multiplexer which can be used in a wide variety of applications.

MPC100 is designed for wide-bandwidth systems, including high-definition television and broadcast equipment. Although it is primarily used to route video signals, the harmonic and dynamic attributes of the MPC100 make it appropriate for other analog signal routing applications such as radar, communications, computer graphics, and data acquisition systems.

The MPC100 consists of four identical monolithic integrated open-loop buffer amplifiers, which are connected internally at the output. The unidirectional transmission path consists of bipolar complementary buffers, which offer extremely high output-to-input isolation. The MPC100 multiplexer enables one of the four input channels to connect to the output. The output of the multiplexer is in a high-impedance state when no channel is selected. When one channel is selected with a digital "1" at the corresponding SEL-input, the component acts as a buffer with high input impedance and low output impedance.

The wide bandwidth of over 250MHz at 1.4Vp-p signal level, high linearity and low distortion, and low input voltage noise of $4\text{nV}/\sqrt{\text{Hz}}$ make this crosspoint switch suitable for RF and video applications. All performance is specified with $\pm 5\text{V}$ supply voltage, which reduces power consumption in comparison with $\pm 15\text{V}$ designs. The multiplexer is available in space-saving SO-14 and DIP packages. Both are designed and specified for operation over the industrial temperature range (-40°C to $+85^\circ\text{C}$).

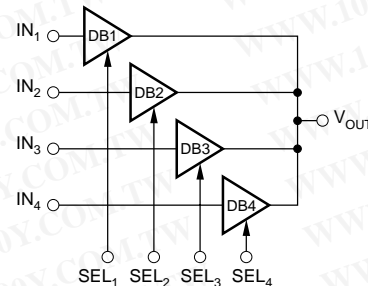

TRUTH TABLE

SEL ₁	SEL ₂	SEL ₃	SEL ₄	V _{OUT}
0	0	0	0	HI-Z
1	0	0	0	IN ₁
0	1	0	0	IN ₂
0	0	1	0	IN ₃
0	0	0	1	IN ₄

SPECIFICATIONS

At $V_{CC} = \pm 5V$, $R_L = 10k\Omega$, $R_{SOURCE} = 50\Omega$, and $T_A = +25^\circ C$, unless otherwise noted.

PARAMETER	CONDITIONS	MPC100AP, AU			UNITS
		MIN	TYP	MAX	
DC CHARACTERISTICS					
INPUT OFFSET VOLTAGE Initial vs Temperature vs Supply (Tracking) vs Supply (Non-tracking) vs Supply (Non-tracking) Initial Matching	$R_{IN} = 0$, $R_{SOURCE} = 0$ $V_{CC} = \pm 4.5V$ to $\pm 5.5V$ $V_{CC} = +4.5V$ to $+5.5V$ $V_{CC} = -4.5V$ to $-5.5V$ Between the Four Channels	-40	+10 ±30 -80 -50 -50 ±3	±30	mV $\mu V/^\circ C$ dB dB dB mV
INPUT BIAS CURRENT Initial vs Temperature vs Supply (Tracking) vs Supply (Non-tracking) vs Supply (Non-tracking)	$V_{CC} = \pm 4.5V$ to $\pm 5.5V$ $V_{CC} = +4.5V$ to $+5.5V$ $V_{CC} = -4.5V$ to $-5.5V$		+4 20 ±380 +1.0 -11.0	±10	μA $nA/^\circ C$ nA/V $\mu A/V$ $\mu A/V$
INPUT IMPEDANCE Resistance Capacitance Capacitance	Channel On Channel On Channel Off		0.88 1.0 1.0		M Ω pF pF
INPUT NOISE Voltage Noise Density Signal-to-Noise Ratio	$f_B = 20kHz$ to $10MHz$ $S/N = 0.7/V_N \cdot \sqrt{5MHz}$		4.0 98		nV/\sqrt{Hz} dB
INPUT VOLTAGE RANGE	Gain Error $\leq 10\%$		±4.2		V
TRANSFER CHARACTERISTICS	Voltage Gain $R_L = 1k\Omega$, $V_{IN} = \pm 2V$ $R_L = 10k\Omega$, $V_{IN} = \pm 2.8V$	0.98	0.982 0.992		V/V V/V
CHANNEL SELECTION INPUTS Logic 1 Voltage Logic 0 Voltage Logic 1 Current Logic 0 Current	$V_{SEL} = 5.0V$ $V_{SEL} = 0.8V$	+2.0 0	100 0.002	V_{CC} +0.8 150 5	V V μA μA
SWITCHING CHARACTERISTICS SEL to Channel ON Time SEL to Channel OFF Time Switching Transient, Positive Switching Transient, Negative	$V_I = -0.3V$ to $+0.7V$, $f = 5MHz$ 90% Point of $V_O = 1Vp-p$ 10% Point of $V_O = 1Vp-p$ Measured While Switching Between Two Grounded Channels		0.25 0.25 +2.5 -1.2		μs μs mV mV
OUTPUT Voltage Resistance Resistance Capacitance	$V_{IN} = \pm 3V$, $R_L = 5k\Omega$ One Channel Selected No Channel Selected No Channel Selected	±2.8	±2.98 11 900 1.5		V Ω M Ω pF
POWER SUPPLY Rated Voltage Derated Performance Quiescent Current	One Channel Selected No Channel Selected	±4.5	±5 ±4.6 ±230	±5.5 ±5 ±350	V V mA μA
TEMPERATURE RANGE Operating, AP, AU Storage, AP, AU Thermal Resistance, θ_{JA} AP, AU		-40 -40		+85 +125	$^\circ C$ $^\circ C$ $^\circ C/W$

勝特力材料 886-3-5753170
 勝特力电子(上海) 86-21-54151736
 勝特力电子(深圳) 86-755-83298787
[Http://www.100y.com.tw](http://www.100y.com.tw)

The information provided herein is believed to be reliable; however, BURR-BROWN assumes no responsibility for inaccuracies or omissions. BURR-BROWN assumes no responsibility for the use of this information, and all use of such information shall be entirely at the user's own risk. Prices and specifications are subject to change without notice. No patent rights or licenses to any of the circuits described herein are implied or granted to any third party. BURR-BROWN does not authorize or warrant any BURR-BROWN product for use in life support devices and/or systems.

SPECIFICATIONS

At $V_{CC} = \pm 5V$, $R_L = 10k\Omega$, $R_{SOURCE} = 50\Omega$, and $T_A = +25^\circ C$, unless otherwise noted.

PARAMETER	CONDITIONS	MPC100AP, AU			UNITS
		MIN	TYP	MAX	
AC CHARACTERISTICS					
FREQUENCY DOMAIN					
LARGE SIGNAL BANDWIDTH (-3dB)	$V_O = 5.0V_{p-p}$, $C_{OUT} = 1pF$		70		MHz
	$V_O = 2.8V_{p-p}$, $C_{OUT} = 1pF$		140		MHz
	$V_O = 1.4V_{p-p}$, $C_{OUT} = 1pF$		250		MHz
SMALL SIGNAL BANDWIDTH	$V_O = 0.2V_{p-p}$, $C_{OUT} = 1pF$		450		MHz
GROUP DELAY TIME			450		ps
DIFFERENTIAL GAIN	$f = 4.43MHz$, $V_{IN} = 0.3V_{p-p}$ VDC = 0 to 0.7V VDC = 0 to 1.4V		0.05		%
			0.06		%
DIFFERENTIAL PHASE	$f = 4.43MHz$, $V_{IN} = 0.3V_{p-p}$ VDC = 0 to 0.7V VDC = 0 to 1.4V		0.01		Degrees
			0.02		Degrees
GAIN FLATNESS PEAKING	$V_O = 0.2V_{p-p}$, DC to 30MHz $V_O = 0.2V_{p-p}$, DC to 100MHz		0.04		dB
			0.05		dB
HARMONIC DISTORTION Second Harmonic Third Harmonic	$f = 30MHz$, $V_O = 1.4V_{p-p}$, $R_L = 1k\Omega$		-53		dBc
			-67		dBc
CROSSTALK MPC100AP All Hostile Off Isolation MPC100AU All Hostile Off Isolation	$V_I = 1.4V_{p-p}$, Figures 4 and 8 $f = 5MHz$, $f = 30MHz$, $f = 5MHz$, $f = 30MHz$, $f = 5MHz$, $f = 30MHz$, $f = 5MHz$, $f = 30MHz$		-82		dB
			-60		dB
			-70		dB
			-71		dB
			-78		dB
			-70		dB
			-75		dB
			-76		dB
TIME DOMAIN					
RISE TIME	$V_O = 1.4V_{p-p}$, Step 10% to 90% $C_{OUT} = 1pF$, $R_{OUT} = 22\Omega$		3.3		ns
SLEW RATE	$V_O = 2V_{p-p}$ $C_{OUT} = 1pF$ $C_{OUT} = 22pF$ $C_{OUT} = 47pF$		650		V/ μs
			460		V/ μs
			320		V/ μs

勝特力材料 886-3-5753170
 勝特力电子(上海) 86-21-54151736
 勝特力电子(深圳) 86-755-83298787
[Http://www.100y.com.tw](http://www.100y.com.tw)

CONNECTION DIAGRAM

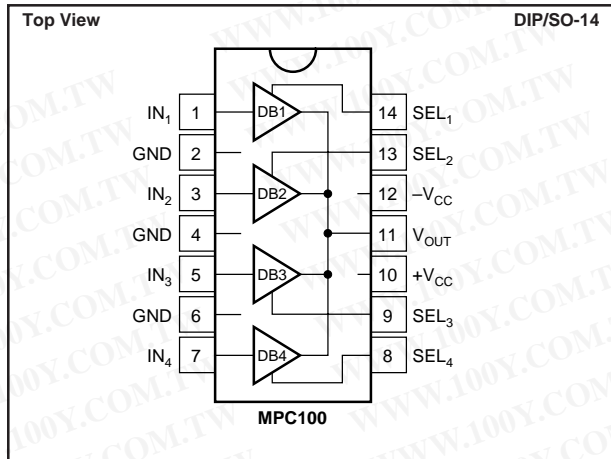

FUNCTIONAL DESCRIPTION

IN ₁ -IN ₄	Four analog input channels
GND	Analog input shielding grounds, connect to system ground
SEL ₁ - SEL ₄	Channel selection inputs
V _{OUT}	Analog output; tracks selected channel
-V _{CC}	Negative supply voltage; typical -5VDC
+V _{CC}	Positive supply voltage; typical +5VDC



ELECTROSTATIC DISCHARGE SENSITIVITY

Electrostatic discharge can cause damage ranging from performance degradation to complete device failure. Burr-Brown Corporation recommends that all integrated circuits be handled and stored using appropriate ESD protection methods.

ESD damage can range from subtle performance degradation to complete device failure. Precision integrated circuits may be more susceptible to damage because very small parametric changes could cause the device not to meet published specifications.

ABSOLUTE MAXIMUM RATINGS

Power Supply Voltage ($\pm V_{CC}$)	$\pm 6V$
Analog Input Voltage (IN ₁ through IN ₄) ⁽¹⁾	$\pm V_{CC}, \pm 0.7V$
Logic Input Voltage	-0.6V to +V _{CC} +0.6V
Operating Temperature	-40°C to +85°C
Storage Temperature	-40°C to +125°C
Output Current	$\pm 6mA$
Junction Temperature	+175°C
Lead Temperature (soldering, 10s)	+300°C
Digital Input Voltages (SEL ₁ through SEL ₄) ⁽¹⁾	-0.5V to +V _{CC} +0.7V

NOTE: (1) Inputs are internally diode-clamped to $\pm V_{CC}$.

PACKAGE/ORDERING INFORMATION

PRODUCT	TEMPERATURE RANGE	PACKAGE	PACKAGE DRAWING NUMBER ⁽¹⁾
MPC100AP	-40°C to +85°C	14-Pin Plastic DIP	010
MPC100AU	-40°C to +85°C	SO-14 Surface Mount	235

NOTE: (1) For detailed drawing and dimension table, please see end of data sheet, or Appendix C of Burr-Brown IC Data Book.

勝特力材料 886-3-5753170
 勝特力电子(上海) 86-21-54151736
 勝特力电子(深圳) 86-755-83298787
[Http://www.100y.com.tw](http://www.100y.com.tw)

TYPICAL PERFORMANCE CURVES

At $V_{CC} = \pm 5V$, $R_{LOAD} = 10k\Omega$, $R_{SOURCE} = 50\Omega$, and $T_A = +25^\circ C$, unless otherwise noted.

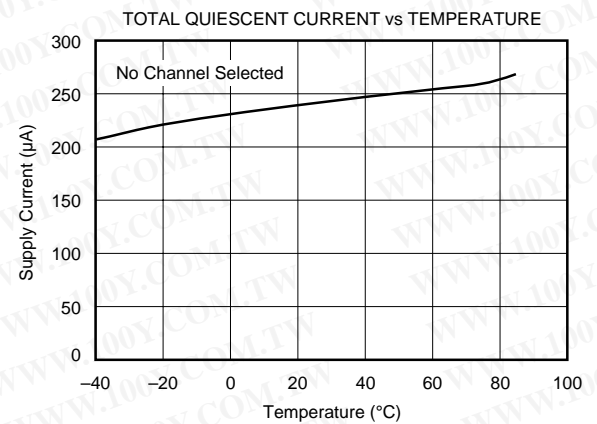
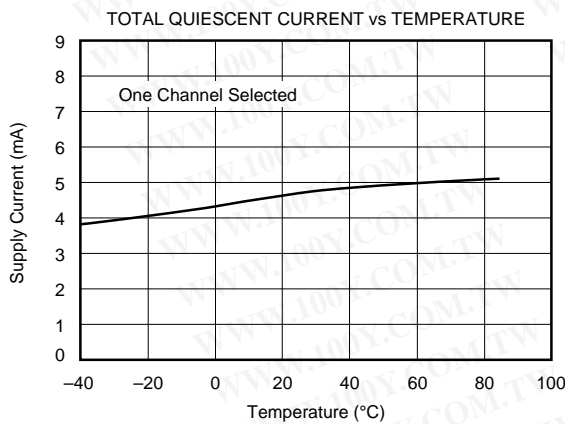
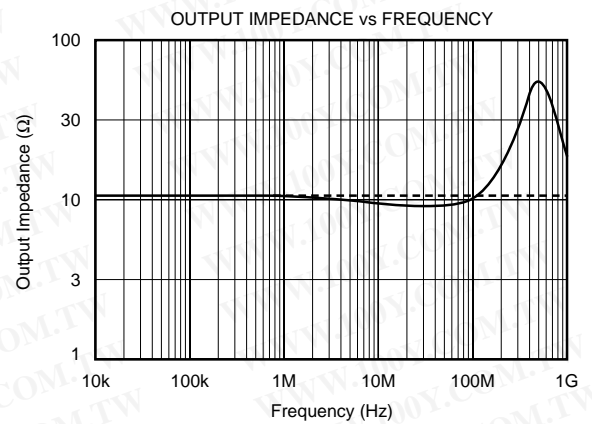
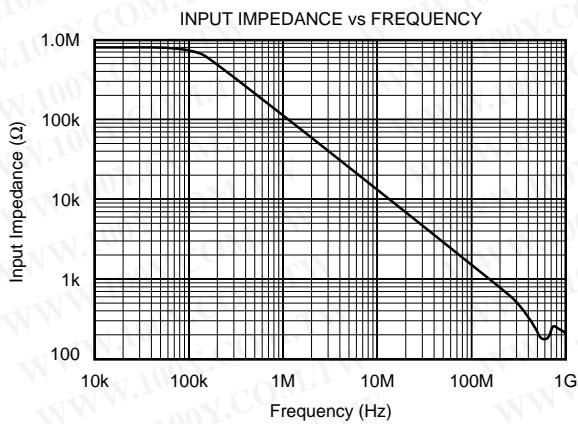
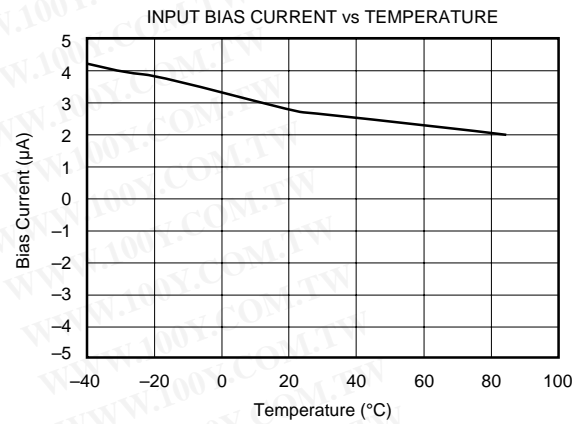
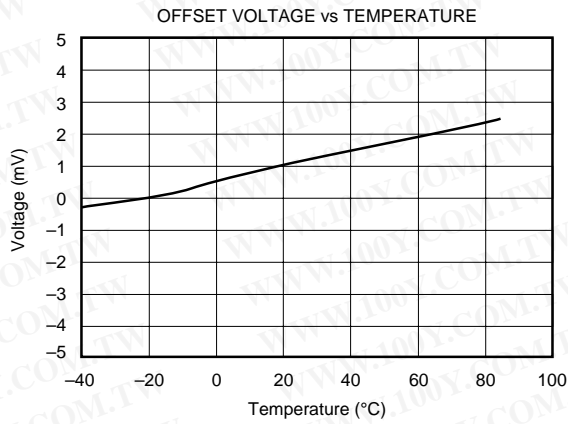

勝特力材料 886-3-5753170
 勝特力电子(上海) 86-21-54151736
 勝特力电子(深圳) 86-755-83298787
[Http://www.100y.com.tw](http://www.100y.com.tw)

TYPICAL PERFORMANCE CURVES (CONT)

At $V_{CC} = \pm 5V$, $R_{LOAD} = 10k\Omega$, $R_{SOURCE} = 50\Omega$, and $T_A = +25^\circ C$, unless otherwise noted.

TRANSFER FUNCTION

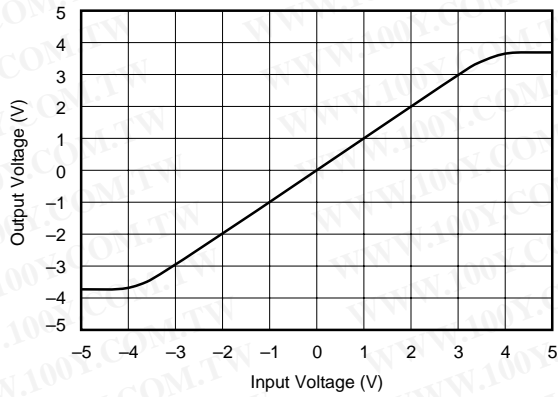

INPUT VOLTAGE NOISE SPECTRAL DENSITY

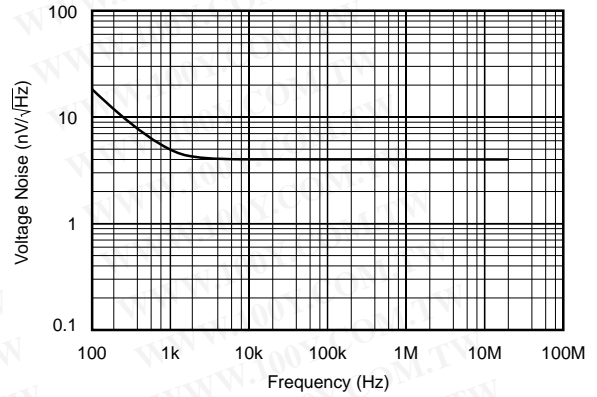

SWITCHING ENVELOPE (Video Signal)

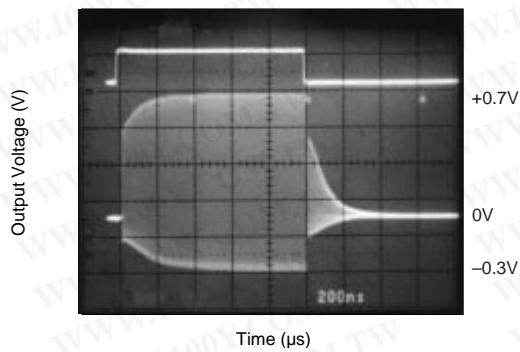

SWITCHING TRANSIENTS (Channel To Channel)

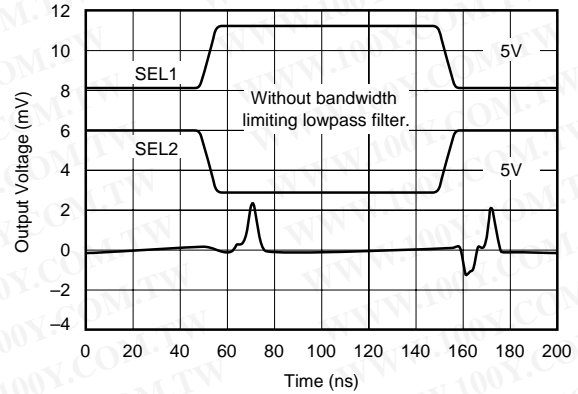

SWITCHING TRANSIENTS (Channel To Channel)

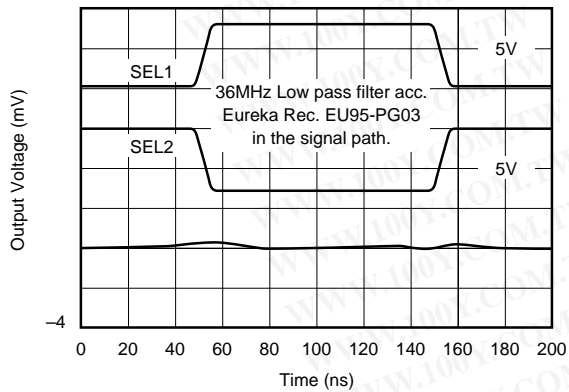

SMALL SIGNAL PULSE RESPONSE

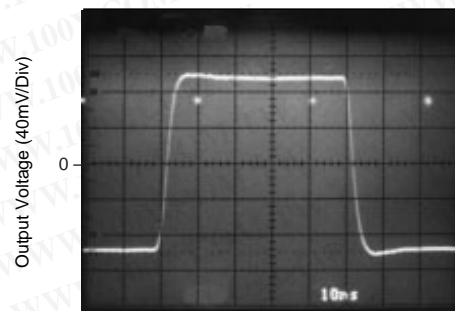

Time (ns)
 $C_{OUT} = 1pF$, $t_{RISE} = t_{FALL} = 2ns$
 (Generator) $V_I = 0.2V_{p-p}$

TYPICAL PERFORMANCE CURVES (CONT)

At $V_{CC} = \pm 5VDC$, $R_{LOAD} = 10k\Omega$, $R_{SOURCE} = 50\Omega$, and $T_A = +25^\circ C$, unless otherwise noted.

勝特力材料 886-3-5753170
 勝特力电子(上海) 86-21-54151736
 勝特力电子(深圳) 86-755-83298787
[Http://www.100y.com.tw](http://www.100y.com.tw)

SMALL SIGNAL PULSE RESPONSE

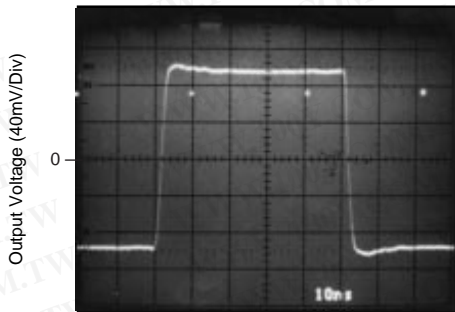

Time (ns)
 $C_{OUT} = 47pF$, $t_{RISE} = t_{FALL} = 2ns$
 (Generator) $V_I = 0.2Vp-p$

LARGE SIGNAL PULSE RESPONSE

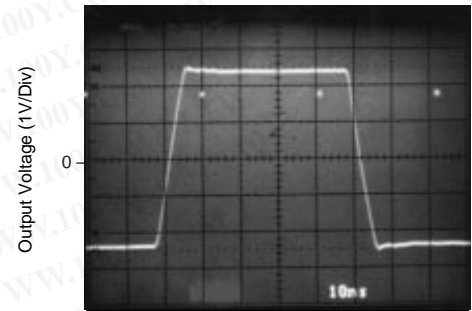

Time (ns)
 $C_{OUT} = 1pF$, $t_{RISE} = t_{FALL} = 5ns$
 (Generator) $V_I = 5Vp-p$

LARGE SIGNAL PULSE RESPONSE

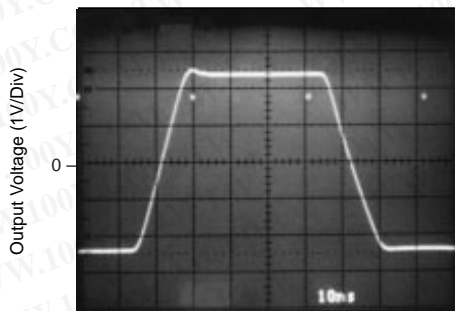

Time (ns)
 $C_{OUT} = 47pF$, $t_{RISE} = t_{FALL} = 5ns$
 (Generator) $V_I = 5Vp-p$

GROUP DELAY TIME vs FREQUENCY

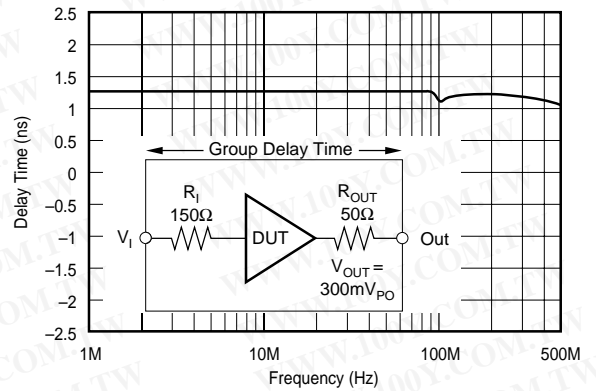

BANDWIDTH vs C_{OUT} WITH RECOMMENDED R_{OUT}

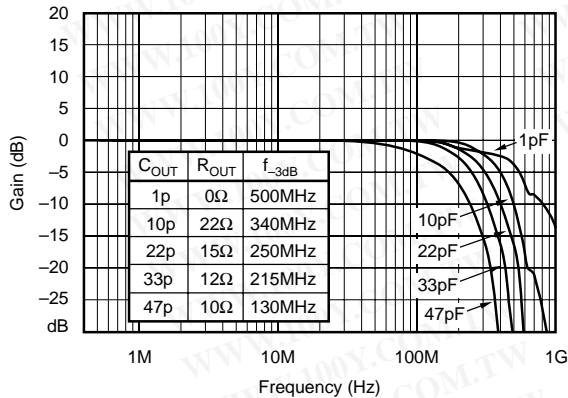

GAIN FLATNESS

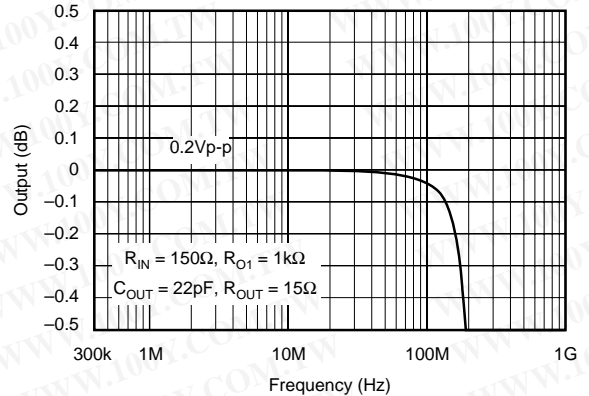

TYPICAL PERFORMANCE CURVES (CONT)

At $V_{CC} = \pm 5V$, $R_{LOAD} = 10k\Omega$, $R_{SOURCE} = 50\Omega$, and $T_A = +25^\circ C$, unless otherwise noted.

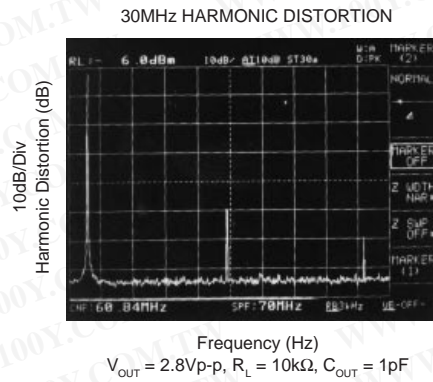
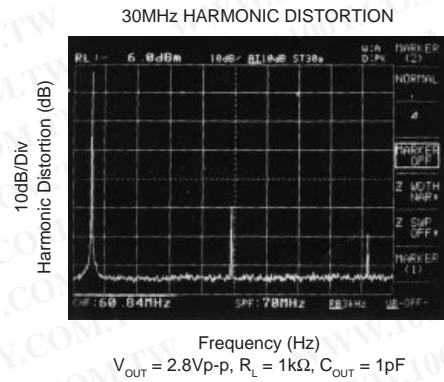
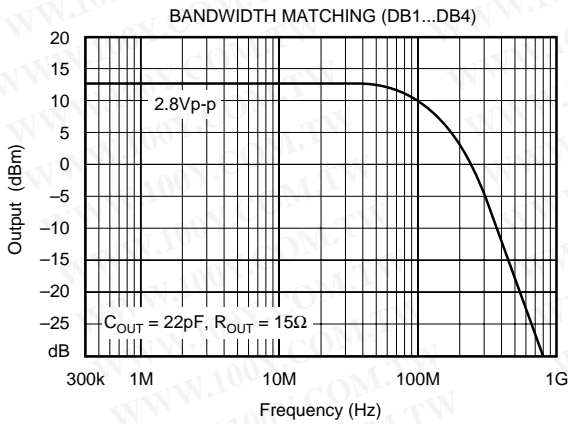
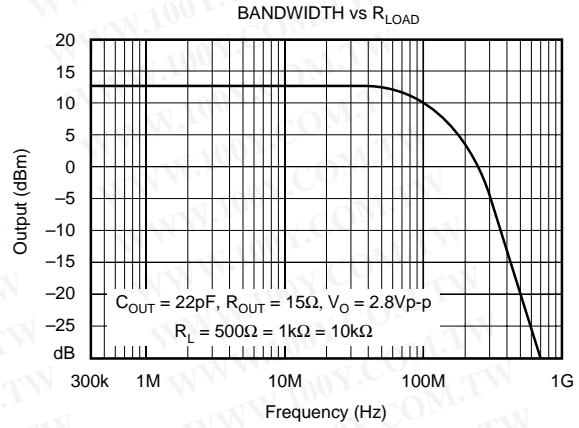
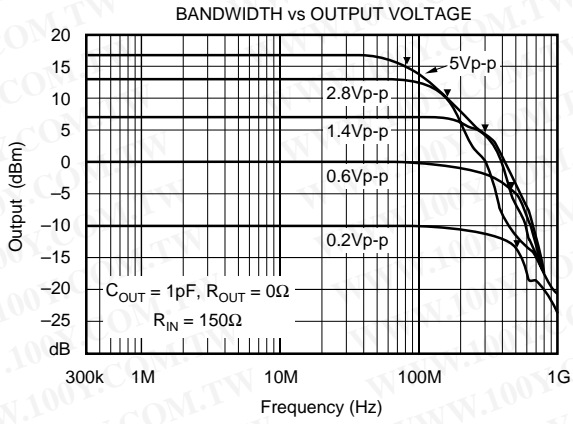

APPLICATIONS INFORMATION

The MPC100 operates from $\pm 5V$ power supplies ($\pm 6V$ maximum). Do not attempt to operate with larger power supply voltages or permanent damage may occur. The buffer outputs are not current-limited or protected. If the output is shorted to ground, currents up to 18mA could flow. Momentary shorts to ground (a few seconds) should be avoided, but are unlikely to cause permanent damage.

INPUT PROTECTION

All pins on the MPC100 are internally protected from ESD by means of a pair of back-to-back reverse-biased diodes to either power supply as shown in Figure 1. These diodes will begin to conduct when the input voltage exceeds either power supply by about 0.7V. This situation can occur with loss of the amplifier's power supplies while a signal source is still present. The diodes can typically withstand a continuous current of 30mA without destruction. To insure long term reliability, however, diode current should be externally limited to 10mA or less whenever possible.

The internal protection diodes are designed to withstand 2.5kV (using Human Body Model) and will provide adequate ESD protection for most normal handling procedures. However, static damage can cause subtle changes in amplifier input characteristics without necessarily destroying the device. In precision buffer amplifiers, this may cause a noticeable degradation of offset voltage and drift. Therefore, static protection is strongly recommended when handling the MPC100.

Static damage has been well recognized for MOSFET devices, but any semiconductor device deserves protection from this potentially damaging source. The MPC100 incorporates on-chip ESD protection diodes as shown in Figure 1. This eliminates the need for the user to add external protection diodes, performance.

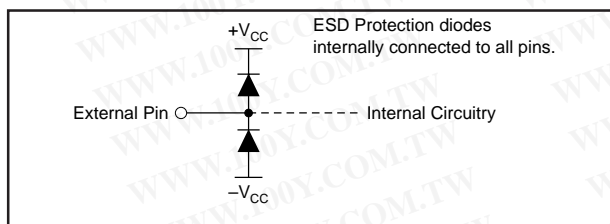

FIGURE 1. Internal ESD Protection.

DISCUSSION OF PERFORMANCE

The MPC100 video multiplexer allows the user to connect any one of four analog input channels (IN_1 - IN_4) to the output of the component and to switch between channels within less than 0.5 μs . It consists of four identical unity-gain buffer amplifiers, which are connected together internally at the output. The open loop buffers consisting of complementary

emitter followers applies no feedback, so their low frequency gain is slightly less than unity and somewhat dependent on loading. Unlike devices using MOS bilateral switching elements, the bipolar complementary buffers form an unidirectional transmission path and thus provide high output-to-input isolation. Switching stages compatible to TTL level digital signals are provided for each buffer to select the input channel. When no channel is selected, the output of the device is high-impedance and allows the user to wire more MPC100s together to form switch multi-channel matrices.

If one channel is selected with a digital "1" at the corresponding SEL-input, the MPC100 acts as a buffer amplifier with high input impedance and low output impedance. The truth table on the front page describes the relationship between the digital inputs (SEL_1 to SEL_4) and the analog inputs (IN_1 to IN_4), and which signal is selected at the output.

The 2-4 address decoder and chip select logic is not integrated. The selected design increases the flexibility of address decoding in complex distribution fields, eases BUS-controlled channel selection, simplifies channel selection monitoring for the user, and lowers transient peaks. All of these characteristics make the multiplexer, in effect, a quad switchable high-speed buffer. It requires DC coupling and termination resistors when directly driven from a low impedance cable. High-current output amplifiers are recommended when driving low-impedance transmission lines or inputs.

An advanced complementary bipolar process, consisting of pn-junction isolated high-frequency NPN and PNP transistors, provides wide bandwidth while maintaining low crosstalk and harmonic distortion. The single chip bandwidth of over 250MHz at an output voltage of 1.4Vp-p allows the design of large crosspoint or distribution fields in HDTV-quality with an overall system bandwidth of 36MHz. The buffer amplifiers also offer low differential gain (0.05%) and phase (0.01 $^\circ$) errors. These parameters are essential for video applications and demonstrate how well the signal path maintains a constant small-signal gain and phase for the low-level color subcarrier at 4.43MHz (PAL) or 3.58MHz (NSTC) as the brightness (luminance) signal is ramped through its specified range. The bipolar construction also ensures that the input impedance remains high and constant between ON and OFF states. The ON/OFF input capacitance ratio is near unity, and does not vary with power supply voltage variations. The low output capacitance of 1.5pF when no channel is selected is a very important parameter for large distribution fields. Each parallel output capacitance is an additional load and reduces the overall system bandwidth.

Bipolar video crosspoint switches are virtually glitch-free when compared to signal switches using CMOS or DMOS devices. The MPC100 operates with a fast make-before-break switching action to keep the output switching transients small and short. Switching from one channel to another causes the signal to mix at the output for a short time, but it interferes only minimally with the input signals.

The transient peaks remain less than +2.5mV and -1.2mV. Subsequent equipment might interpret large negative output glitches as synchronization pulses. To remove this problem, the output must be clamped during the switching dead time. With the MPC100, the generated output transients are extremely small and clamping is unnecessary. The switching time between two channels is less than 0.5μs. This short time period allows easy switching during the vertical blanking time. The signal envelope during the transition from one channel to another rises and falls symmetrically and shows less overshooting or DC settling transients.

Power consumption is a serious problem when designing large crosspoint fields with high component density. Most of the buffers are always in off-state. One important design goal was to attain low off-state quiescent current when no channel is selected. The low supply current of ±230μA in off-state and ±4.6mA when one channel is selected, as well as the reduced ±5V supply voltage, conserves power, simplifies the power supply design, and results in cooler, more reliable operation.

CIRCUIT LAYOUT

The high-frequency performance of the MPC100 can be greatly affected by the physical layout of the circuit. The following tips are offered as suggestions, not as absolutes. Oscillations, ringing, poor bandwidth and settling, higher crosstalk, and peaking are all typical problems which plague high-speed components when they are used incorrectly.

- Bypass power supplies very close to the device pins. Use tantalum chip capacitors (approximately 2.2μF), a parallel 470pF ceramic chip capacitor may be added if desired. Surface-mount types are recommended due to their low lead inductance.
- PC board traces for signal and power lines should be wide to reduce impedance or inductance.
- Make short and low inductance traces. The entire physical circuit layout should be as small as possible.
- Use a low-impedance ground plane on the component side to ensure that low-impedance ground is available throughout the layout. Grounded traces between the input traces are essential to achieve high interchannel crosstalk rejection. Refer to the suggested layout shown in Figure 6.
- Do not extend the ground plane under high-impedance nodes sensitive to stray capacitances, such as the buffer's input terminals.
- Sockets are not recommended because they add significant inductance and parasitic capacitance. If sockets are required, use zero-profile solderless sockets.
- Use low-inductance and surface-mounted components to achieve the best AC-performance.
- A resistor (100Ω to 200Ω) in series with the input of the buffers may help to reduce peaking. Place the resistor as close as possible to the pin.
- Plug-in prototype boards and wire-wrap boards will not function well. A clean layout using RF techniques is essential.

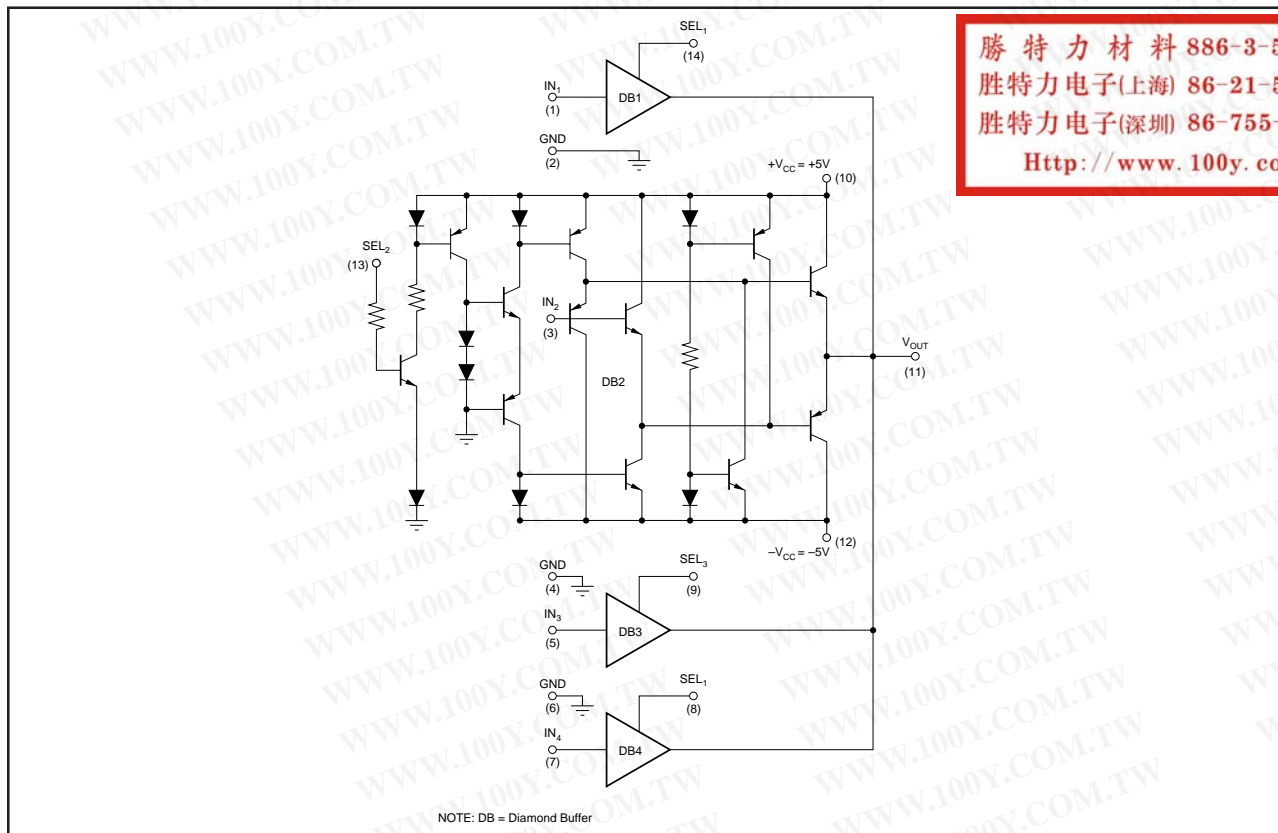

勝特力材料 886-3-5753170
勝特力电子(上海) 86-21-54151736
勝特力电子(深圳) 86-755-83298787
[Http://www.100y.com.tw](http://www.100y.com.tw)

FIGURE 2. Simplified Circuit Diagram.

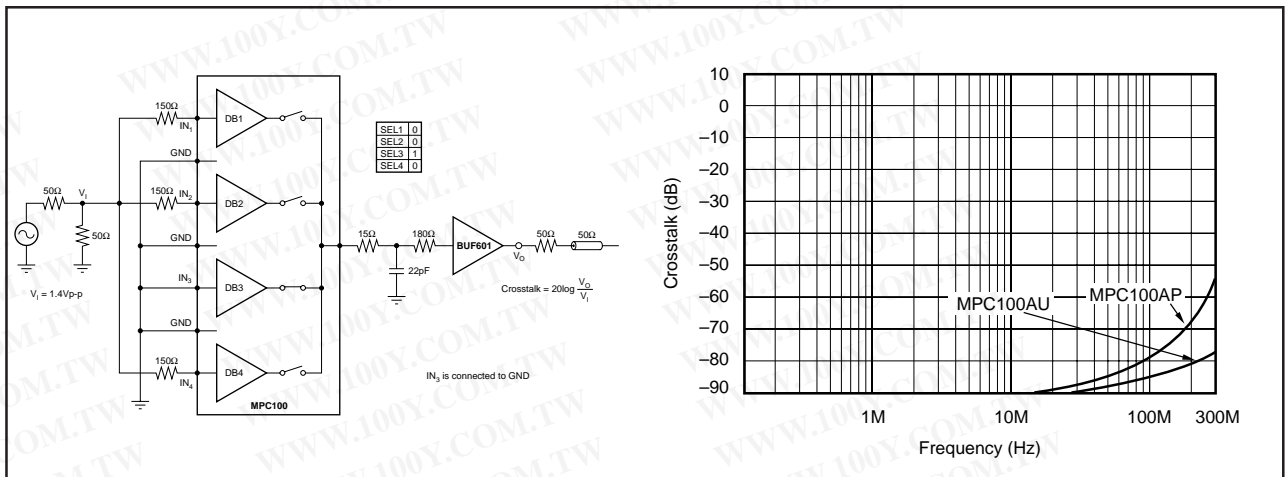

FIGURE 3. Channel Crosstalk—Grounded Input.

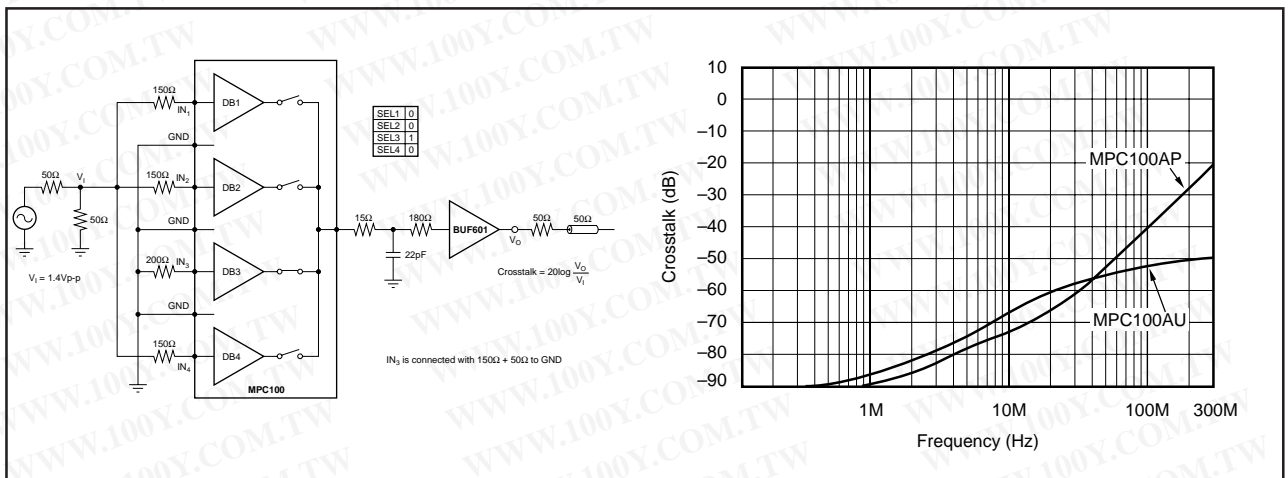

FIGURE 4. Channel Crosstalk—150Ω Input Resistor.

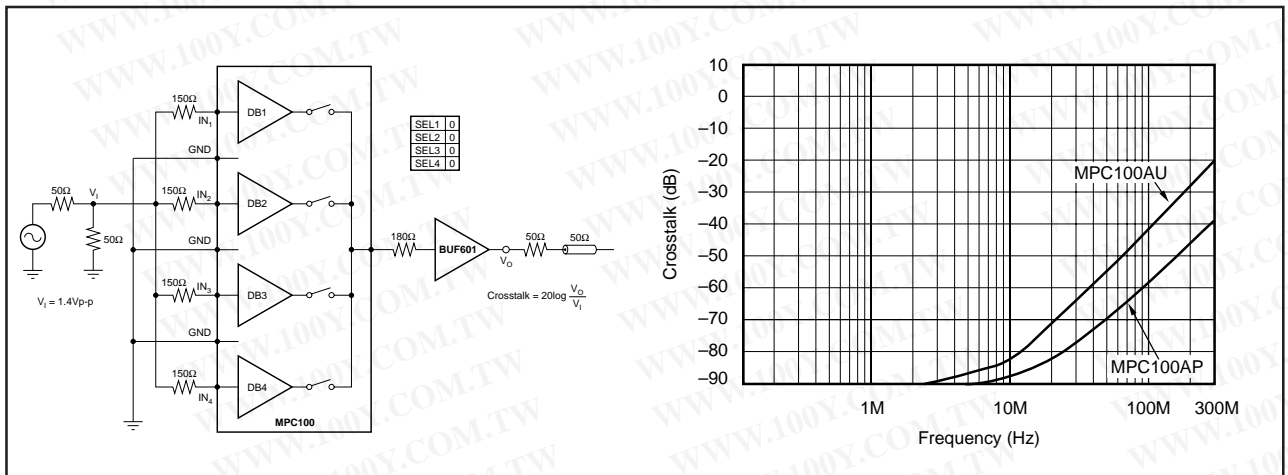

FIGURE 5. Off Isolation.

勝特力材料 86-3-5753170
 勝特力电子(上海) 86-21-54151736
 勝特力电子(深圳) 86-755-83298787
[Http://www.100y.com.tw](http://www.100y.com.tw)

勝特力材料 886-3-5753170
 勝特力电子(上海) 86-21-54151736
 勝特力电子(深圳) 86-755-83298787
[Http://www.100y.com.tw](http://www.100y.com.tw)

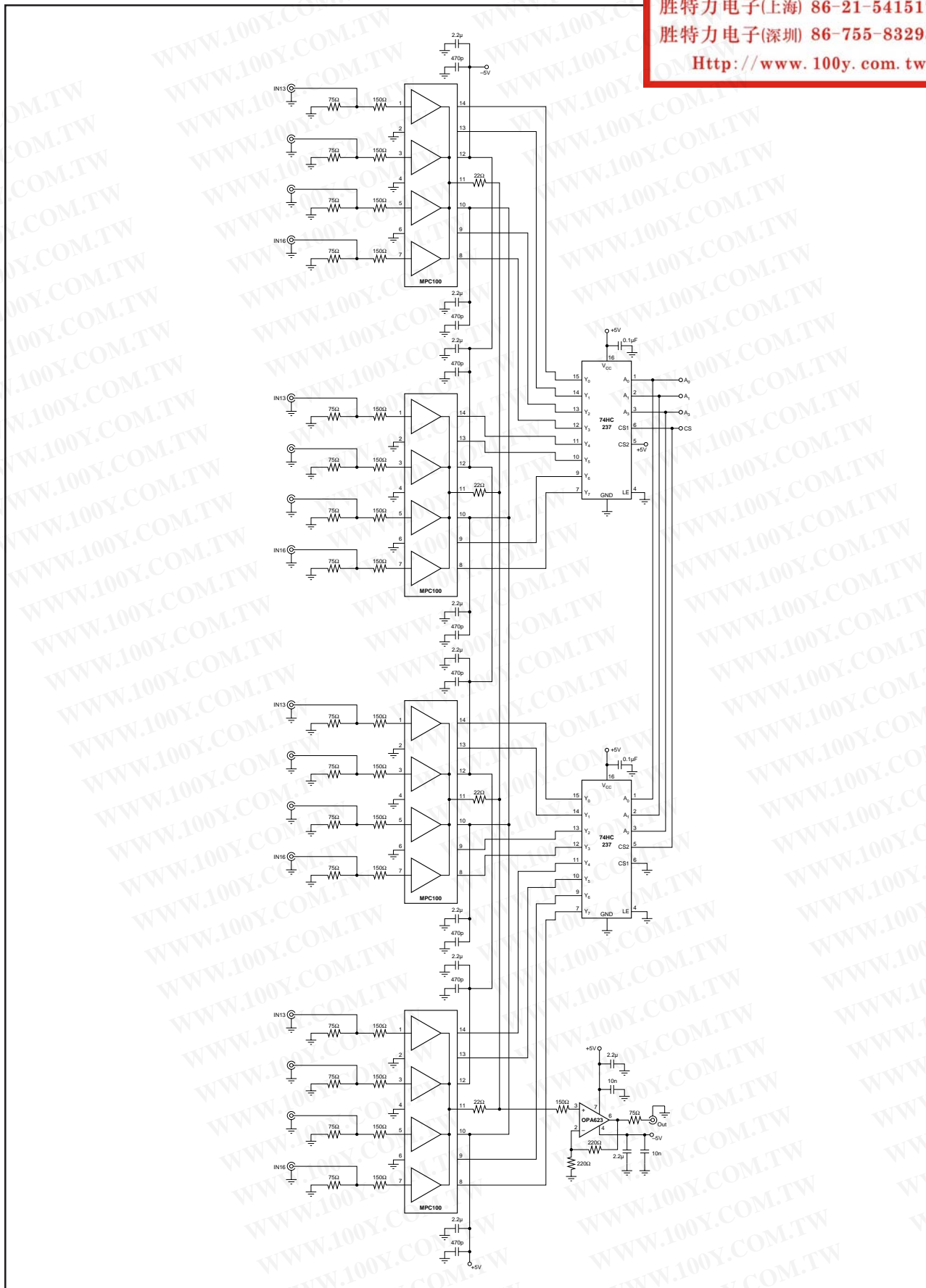

FIGURE 6. Video Distribution Field.

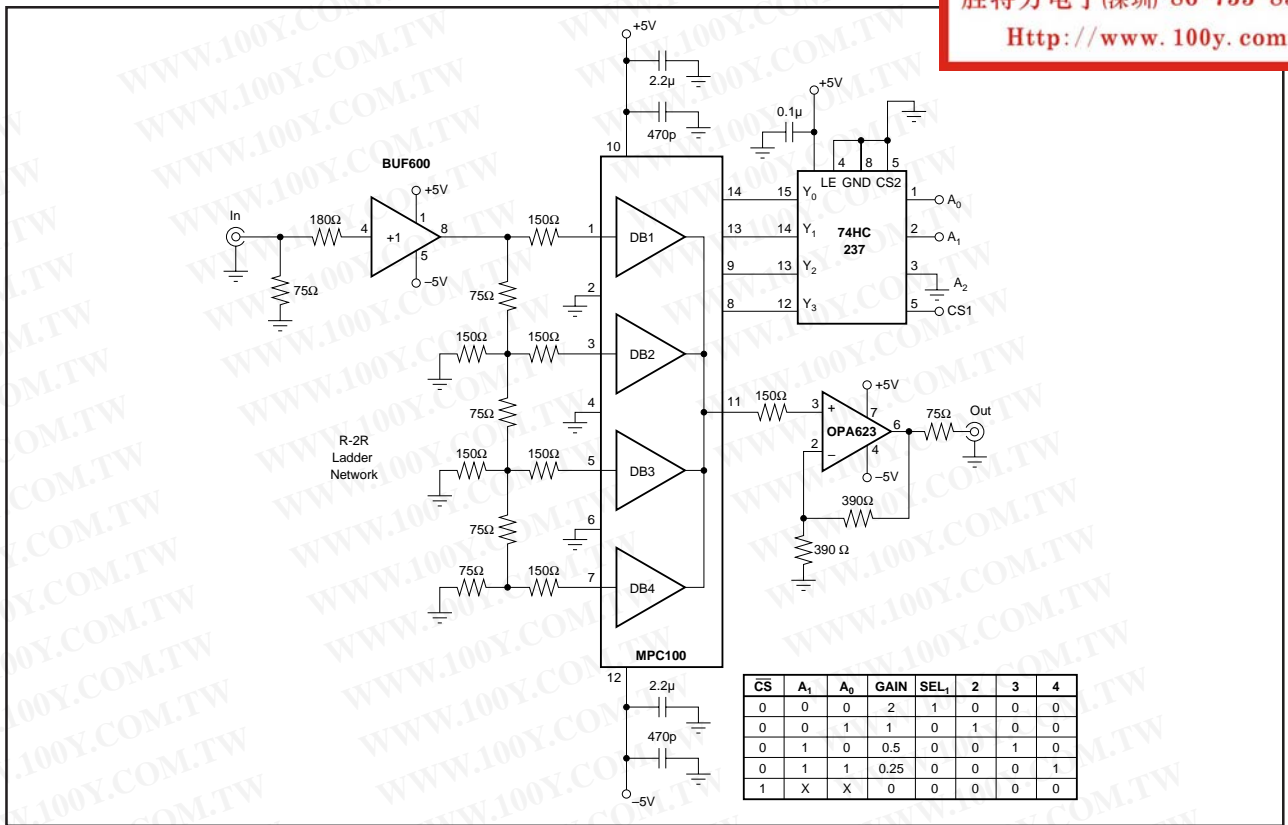

FIGURE 7. Digital Gain Control.

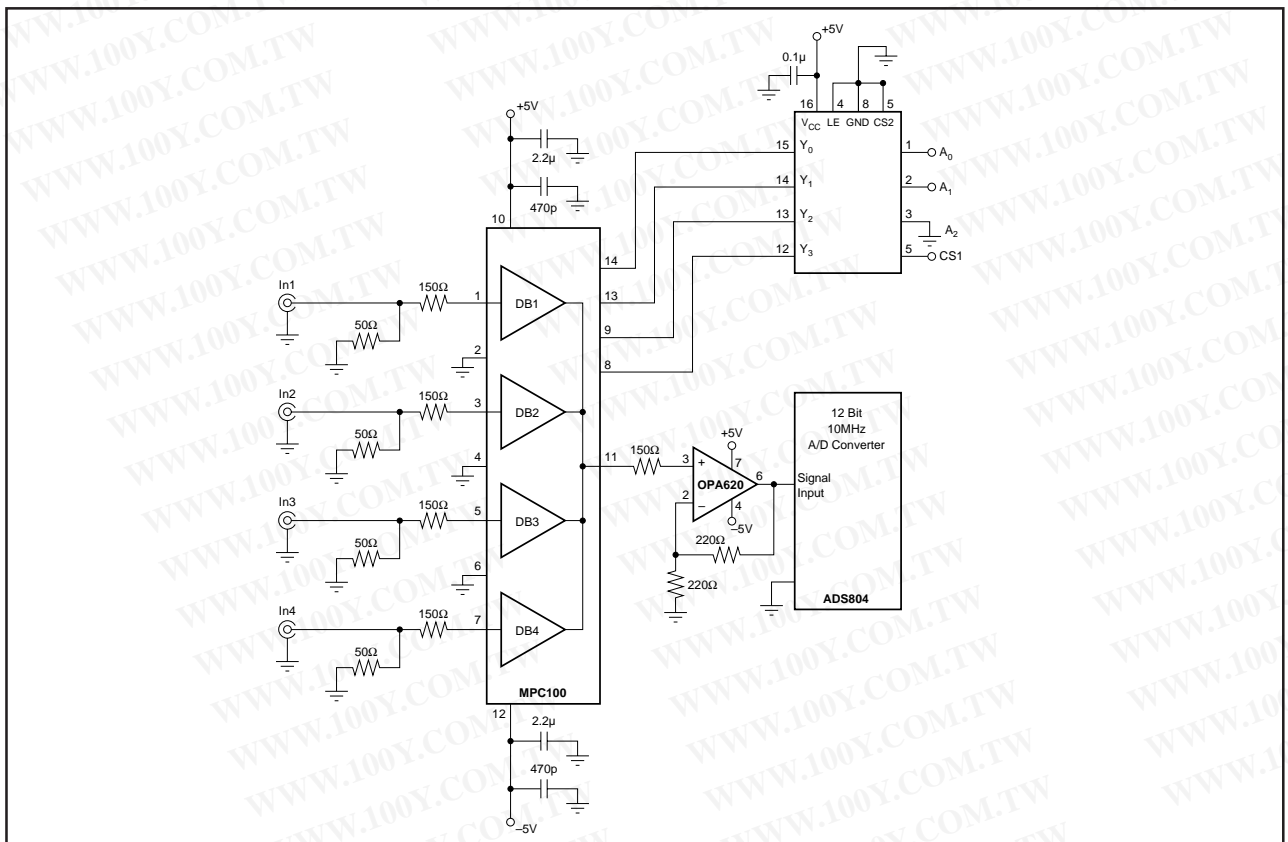

FIGURE 8. High Speed Data Acquisition System.

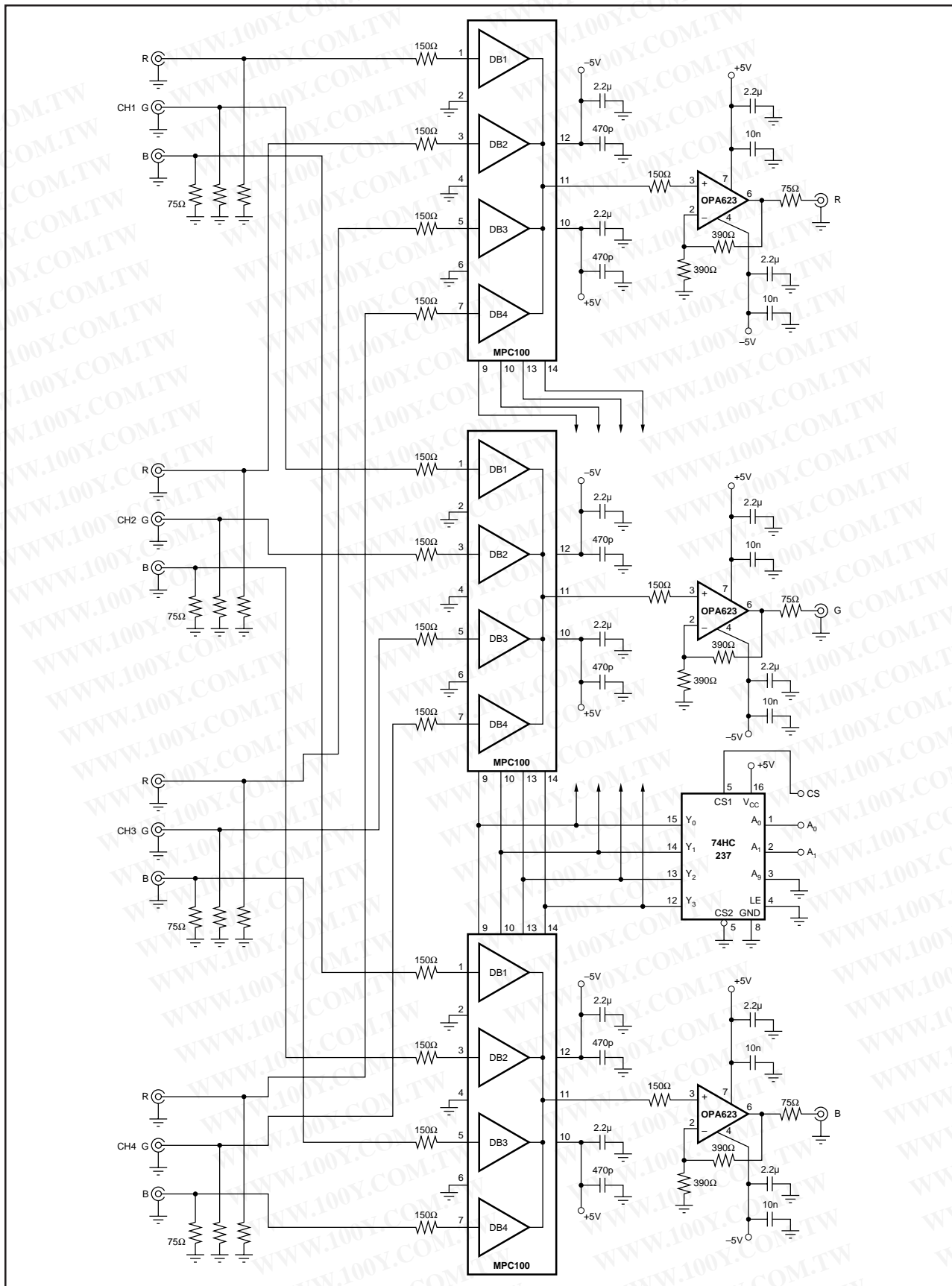

FIGURE 9. Distribution Field for High Resolution Graphic Cards, Cameras.

勝特力材料 886-3-5753170
 勝特力电子(上海) 86-21-54151736
 勝特力电子(深圳) 86-755-83298787
[Http://www.100y.com.tw](http://www.100y.com.tw)

PACKAGING INFORMATION

Orderable Device	Status ⁽¹⁾	Package Type	Package Drawing	Pins	Package Qty	Eco Plan ⁽²⁾	Lead/Ball Finish	MSL Peak Temp ⁽³⁾
MPC100AP	OBSOLETE	PDIP	N	14		TBD	Call TI	Call TI
MPC100AU	OBSOLETE	SOIC	D	14		TBD	Call TI	Call TI
MPC100AU/2K5	OBSOLETE	SOIC	D	14		TBD	Call TI	Call TI

⁽¹⁾ The marketing status values are defined as follows:

ACTIVE: Product device recommended for new designs.

LIFEBUY: TI has announced that the device will be discontinued, and a lifetime-buy period is in effect.

NRND: Not recommended for new designs. Device is in production to support existing customers, but TI does not recommend using this part in a new design.

PREVIEW: Device has been announced but is not in production. Samples may or may not be available.

OBSOLETE: TI has discontinued the production of the device.

⁽²⁾ Eco Plan - The planned eco-friendly classification: Pb-Free (RoHS) or Green (RoHS & no Sb/Br) - please check <http://www.ti.com/productcontent> for the latest availability information and additional product content details.

TBD: The Pb-Free/Green conversion plan has not been defined.

Pb-Free (RoHS): TI's terms "Lead-Free" or "Pb-Free" mean semiconductor products that are compatible with the current RoHS requirements for all 6 substances, including the requirement that lead not exceed 0.1% by weight in homogeneous materials. Where designed to be soldered at high temperatures, TI Pb-Free products are suitable for use in specified lead-free processes.

Green (RoHS & no Sb/Br): TI defines "Green" to mean Pb-Free (RoHS compatible), and free of Bromine (Br) and Antimony (Sb) based flame retardants (Br or Sb do not exceed 0.1% by weight in homogeneous material)

⁽³⁾ MSL, Peak Temp. -- The Moisture Sensitivity Level rating according to the JEDEC industry standard classifications, and peak solder temperature.

Important Information and Disclaimer:The information provided on this page represents TI's knowledge and belief as of the date that it is provided. TI bases its knowledge and belief on information provided by third parties, and makes no representation or warranty as to the accuracy of such information. Efforts are underway to better integrate information from third parties. TI has taken and continues to take reasonable steps to provide representative and accurate information but may not have conducted destructive testing or chemical analysis on incoming materials and chemicals. TI and TI suppliers consider certain information to be proprietary, and thus CAS numbers and other limited information may not be available for release.

In no event shall TI's liability arising out of such information exceed the total purchase price of the TI part(s) at issue in this document sold by TI to Customer on an annual basis.

勝特力材料 886-3-5753170
 勝特力电子(上海) 86-21-54151736
 勝特力电子(深圳) 86-755-83298787
 Http://www.100y.com.tw

IMPORTANT NOTICE

Texas Instruments Incorporated and its subsidiaries (TI) reserve the right to make corrections, modifications, enhancements, improvements, and other changes to its products and services at any time and to discontinue any product or service without notice. Customers should obtain the latest relevant information before placing orders and should verify that such information is current and complete. All products are sold subject to TI's terms and conditions of sale supplied at the time of order acknowledgment.

TI warrants performance of its hardware products to the specifications applicable at the time of sale in accordance with TI's standard warranty. Testing and other quality control techniques are used to the extent TI deems necessary to support this warranty. Except where mandated by government requirements, testing of all parameters of each product is not necessarily performed.

TI assumes no liability for applications assistance or customer product design. Customers are responsible for their products and applications using TI components. To minimize the risks associated with customer products and applications, customers should provide adequate design and operating safeguards.

TI does not warrant or represent that any license, either express or implied, is granted under any TI patent right, copyright, mask work right, or other TI intellectual property right relating to any combination, machine, or process in which TI products or services are used. Information published by TI regarding third-party products or services does not constitute a license from TI to use such products or services or a warranty or endorsement thereof. Use of such information may require a license from a third party under the patents or other intellectual property of the third party, or a license from TI under the patents or other intellectual property of TI.

Reproduction of information in TI data books or data sheets is permissible only if reproduction is without alteration and is accompanied by all associated warranties, conditions, limitations, and notices. Reproduction of this information with alteration is an unfair and deceptive business practice. TI is not responsible or liable for such altered documentation.

Resale of TI products or services with statements different from or beyond the parameters stated by TI for that product or service voids all express and any implied warranties for the associated TI product or service and is an unfair and deceptive business practice. TI is not responsible or liable for any such statements.

Following are URLs where you can obtain information on other Texas Instruments products and application solutions:

Products

Amplifiers	amplifier.ti.com
Data Converters	dataconverter.ti.com
DSP	dsp.ti.com
Interface	interface.ti.com
Logic	logic.ti.com
Power Mgmt	power.ti.com
Microcontrollers	microcontroller.ti.com

Applications

Audio	www.ti.com/audio
Automotive	www.ti.com/automotive
Broadband	www.ti.com/broadband
Digital Control	www.ti.com/digitalcontrol
Military	www.ti.com/military
Optical Networking	www.ti.com/opticalnetwork
Security	www.ti.com/security
Telephony	www.ti.com/telephony
Video & Imaging	www.ti.com/video
Wireless	www.ti.com/wireless

Mailing Address: Texas Instruments
Post Office Box 655303 Dallas, Texas 75265

Copyright © 2005, Texas Instruments Incorporated

勝特力材料 886-3-5753170
勝特力电子(上海) 86-21-54151736
勝特力电子(深圳) 86-755-83298787
[Http://www.100y.com.tw](http://www.100y.com.tw)