

MINI USB/10P FEMALE/SMT B TYPE

MATERIAL SPECIFICATION

SHELL	COPPER ALLOY
HOUSING	THERMOPLASTIC, UL94V-0
COLOR	BLACK
CONTACT	COPPER ALLOY

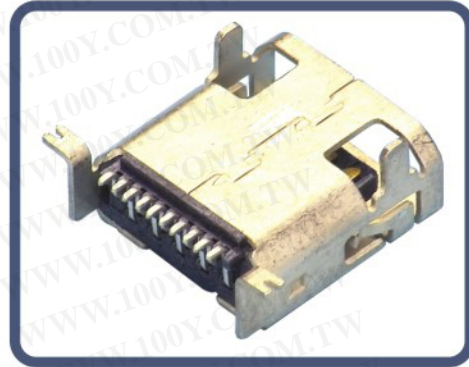

ELECTRICAL CHARACTERISTIC

VOLTAGE CURRENT RATING	1.5AMP, 250V AC
INSULATION RESISTANCE	100 mΩ Min.
CONTACT RESISTANCE	30mΩ Max.
DIELECTRIC WITHSTANDING VOLTAGE	AC 500V R.M.S.
TEMPERATURE RANGE	-50°C TO +85°C

PART NO. SPECIFICATION

MUNF-10*T-BV40



勝特力材料 886-3-5753170
 勝特力电子(上海) 86-21-54151736
 勝特力电子(深圳) 86-755-83298787
[Http://www.100y.com.tw](http://www.100y.com.tw)

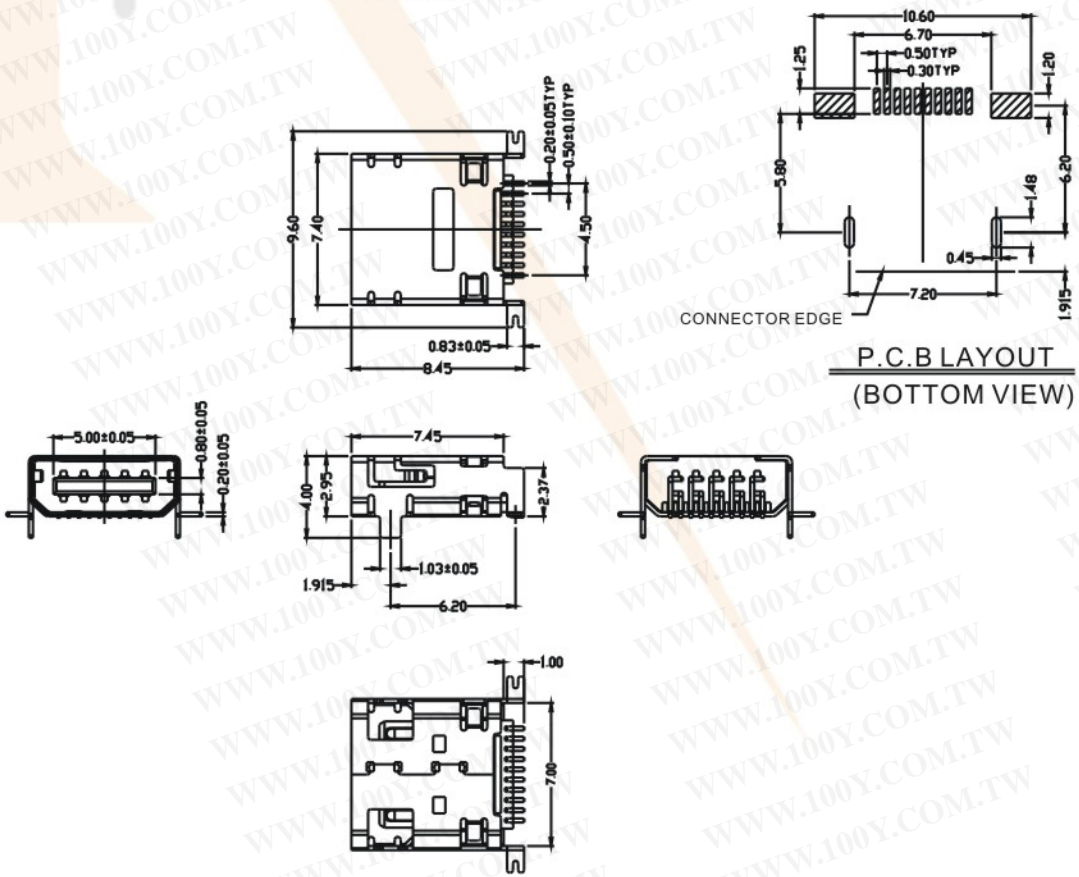

MINI USB CONNECTOR



MINI USB/12P FEMALE/SMT B TYPE

MATERIAL SPECIFICATION

SHELL	COPPER ALLOY
HOUSING	THERMOPLASTIC, UL94V-0
COLOR	BLACK
CONTACT	COPPER ALLOY

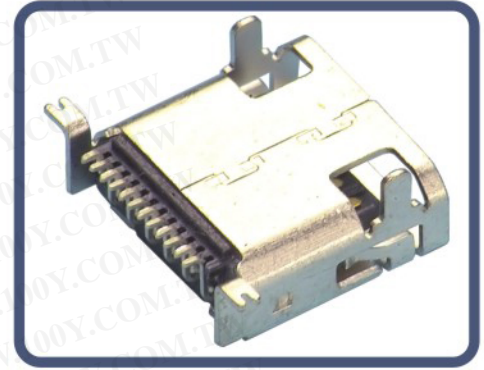

ELECTRICAL CHARACTERISTIC

VOLTAGE CURRENT RATING	1.5AMP, 250V AC
INSULATION RESISTANCE	100 mΩ Min.
CONTACT RESISTANCE	30mΩ Max.
DIELECTRIC WITHSTANDING VOLTAGE	AC500V R.M.S.
TEMPERATURE RANGE	-50°C TO +85°C

PART NO. SPECIFICATION

MUNF-12*T-BV00

勝特力材料 886-3-5753170
 勝特力电子(上海) 86-21-54151736
 勝特力电子(深圳) 86-755-83298787
[Http://www.100y.com.tw](http://www.100y.com.tw)

1 : Au 1U"
 6 : Au 30U"

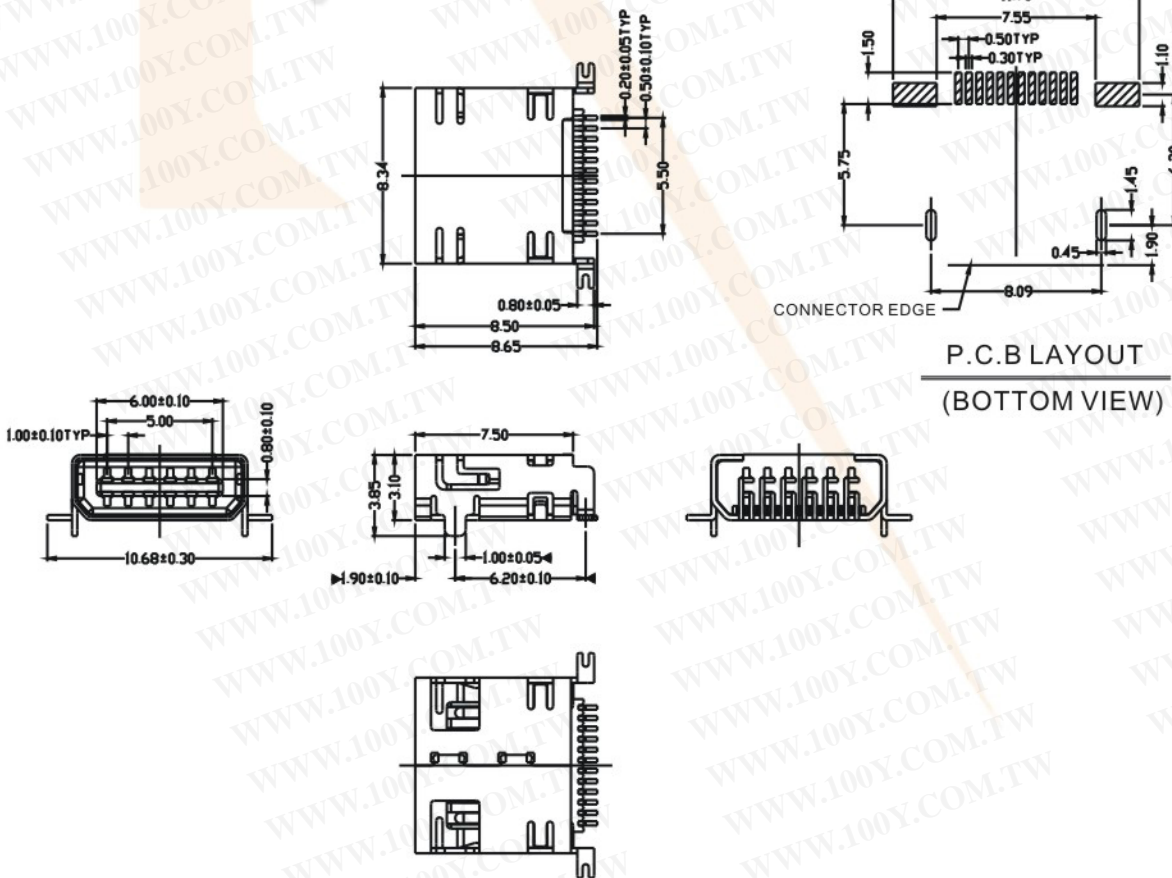

MINI USB/14P FEMALE/SMT B TYPE

MATERIAL SPECIFICATION

SHELL	COPPER ALLOY
HOUSING	THERMOPLASTIC, UL94V-0
COLOR	BLACK
CONTACT	COPPER ALLOY

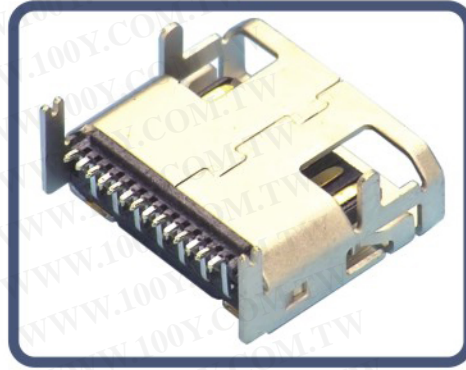

ELECTRICAL CHARACTERISTIC

VOLTAGE CURRENT RATING	1.5AMP, 250V AC
INSULATION RESISTANCE	100 mΩ Min.
CONTACT RESISTANCE	30mΩ Max.
DIELECTRIC WITHSTANDING VOLTAGE	AC 500V R.M.S.
TEMPERATURE RANGE	-50°C TO +85°C

PART NO. SPECIFICATION

MUNF-14*T-BV00

勝特力材料 886-3-5753170
 勝特力电子(上海) 86-21-54151736
 勝特力电子(深圳) 86-755-83298787
[Http://www.100y.com.tw](http://www.100y.com.tw)

1 : Au 1U"
 6 : Au 30U"

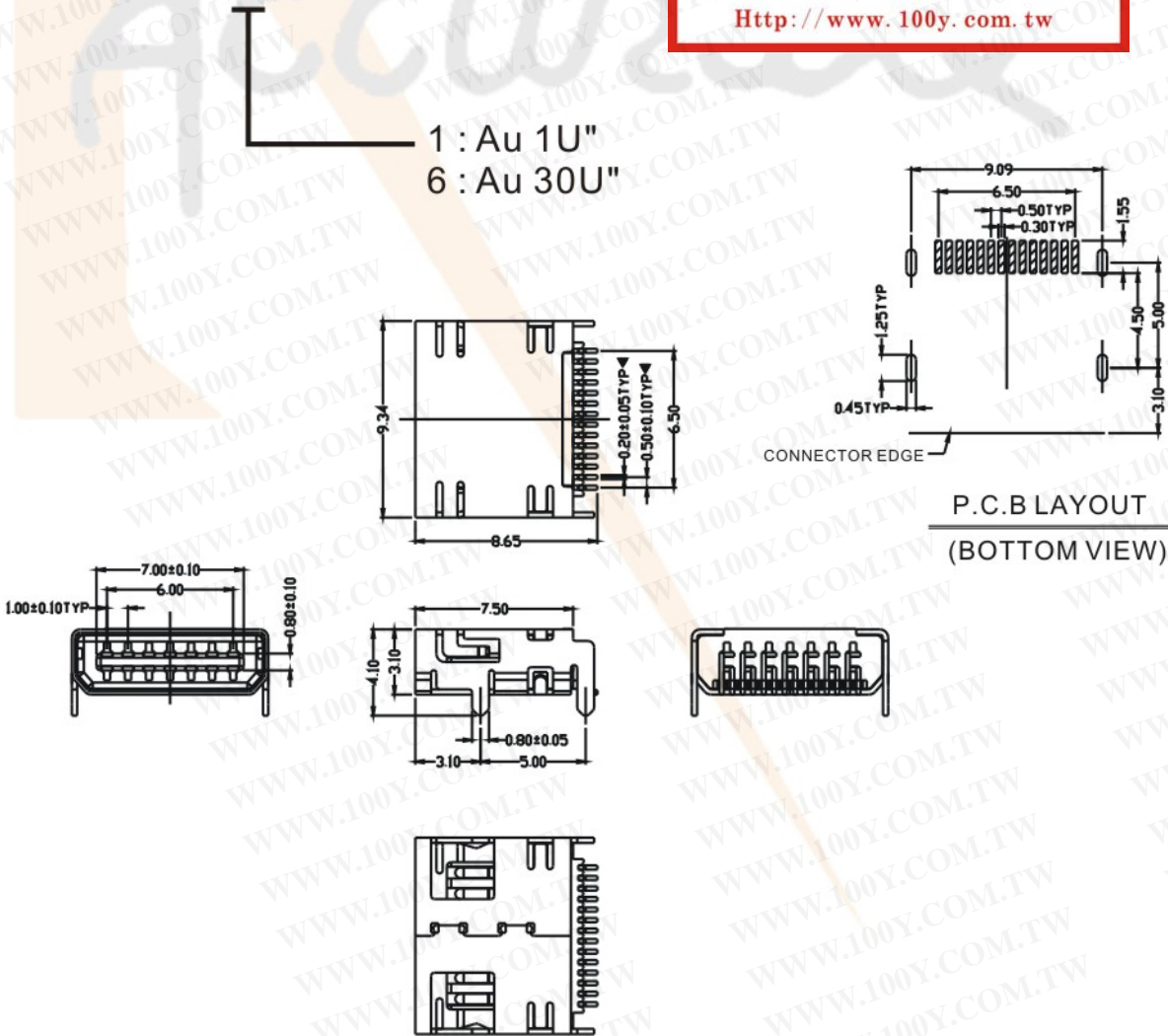

MINI USB CONNECTOR



MINI USB/14P FEMALE/SMT B TYPE

MATERIAL SPECIFICATION

SHELL	COPPER ALLOY
HOUSING	THERMOPLASTIC, UL94V-0
COLOR	BLACK
CONTACT	COPPER ALLOY

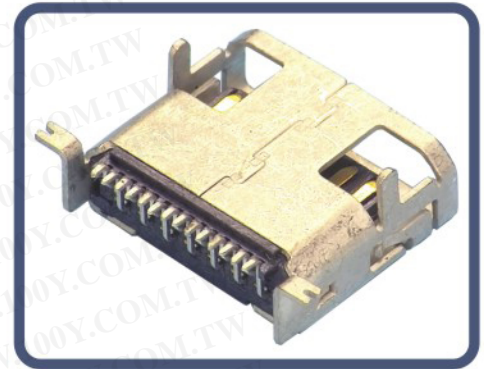

ELECTRICAL CHARACTERISTIC

VOLTAGE CURRENT RATING	1.5AMP, 250V AC
INSULATION RESISTANCE	100 mΩ Min.
CONTACT RESISTANCE	30mΩ Max.
DIELECTRIC WITHSTANDING VOLTAGE	AC 500V R.M.S.
TEMPERATURE RANGE	-50°C TO +85°C

PART NO. SPECIFICATION

MUNF-14*T-BV50

勝特力材料 886-3-5753170
 勝特力电子(上海) 86-21-54151736
 勝特力电子(深圳) 86-755-83298787
[Http://www.100y.com.tw](http://www.100y.com.tw)

1 : Au 1U"
 6 : Au 30U"

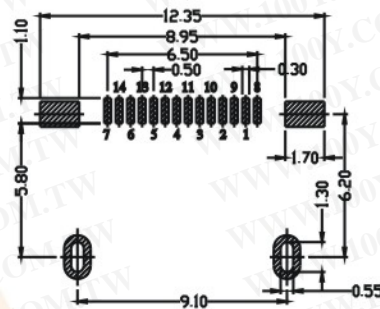
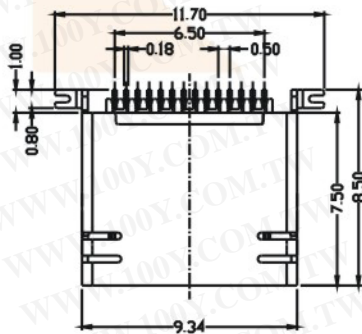

P.C.B LAYOUT
(TOP VIEW)

