

MINI USB/8P FEMALE/SMT B TYPE



MINI USB CONNECTOR

MATERIAL SPECIFICATION

SHELL	COPPER ALLOY
HOUSING	THERMOPLASTIC, UL94V-0
COLOR	BLACK
CONTACT	COPPER ALLOY

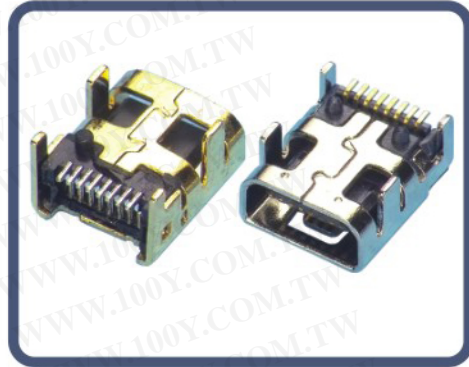

ELECTRICAL CHARACTERISTIC

VOLTAGE CURRENT RATING	0.5AMP, 30V AC
INSULATION RESISTANCE	100 mΩ Min.
CONTACT RESISTANCE	50mΩ Max.
DIELECTRIC WITHSTANDING VOLTAGE	AC 500V R.M.S.
TEMPERATURE RANGE	-40°C TO +85°C

PART NO. SPECIFICATION

MUBF-08* *-BV40



勝特力材料 886-3-5753170
 勝特力电子(上海) 86-21-54151736
 勝特力电子(深圳) 86-755-83298787
[Http://www.100y.com.tw](http://www.100y.com.tw)

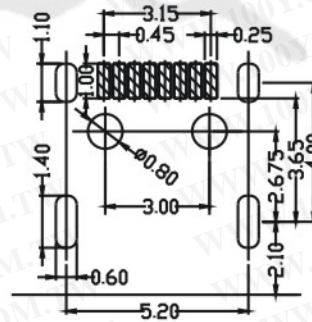

P.C.B LAYOUT

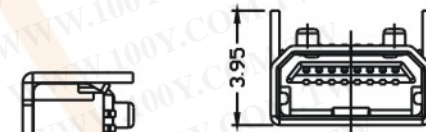
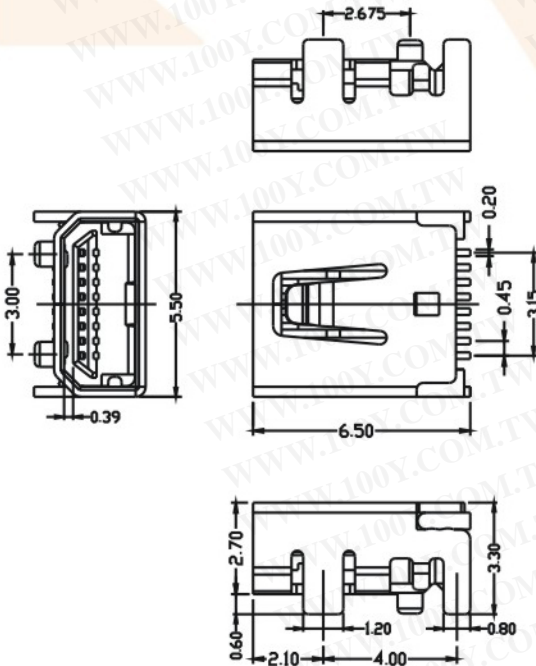

MUBF-08* *-BV02

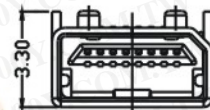

MUBF-08* *-BV41

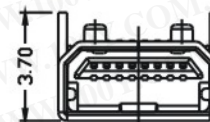

MUBF-08* *-BV42



MINI USB/8P FEMALE/SMT B TYPE

MATERIAL SPECIFICATION

SHELL	COPPER ALLOY
HOUSING	THERMOPLASTIC, UL94V-0
COLOR	BLACK
CONTACT	COPPER ALLOY

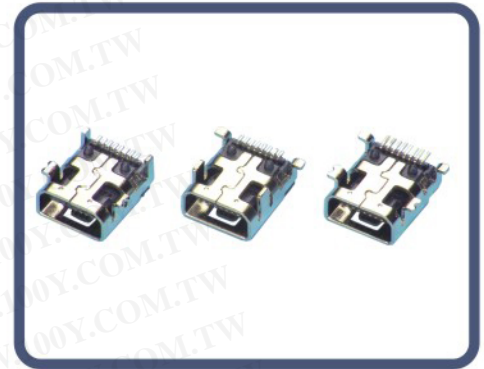

ELECTRICAL CHARACTERISTIC

VOLTAGE CURRENT RATING	0.5AMP, 30V AC
INSULATION RESISTANCE	100 mΩ Min.
CONTACT RESISTANCE	50mΩ Max.
DIELECTRIC WITHSTANDING VOLTAGE	AC 500V R.M.S.
TEMPERATURE RANGE	-40°C TO +85°C

PART NO. SPECIFICATION

MUBF-08* *-BH40



勝特力材料 886-3-5753170
勝特力电子(上海) 86-21-54151736
勝特力电子(深圳) 86-755-83298787
[Http://www.100y.com.tw](http://www.100y.com.tw)

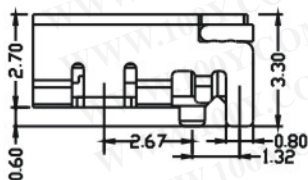
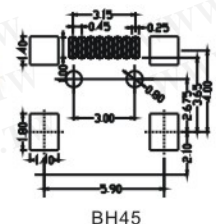
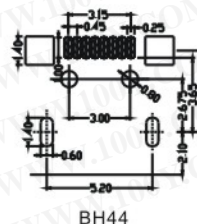
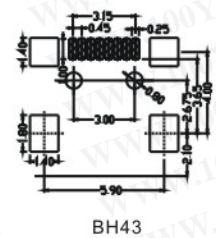
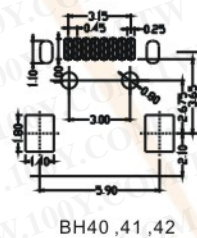
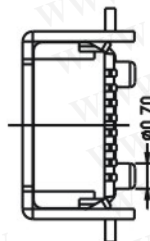
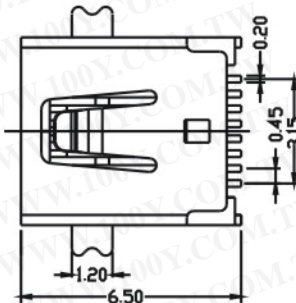
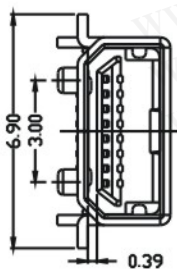
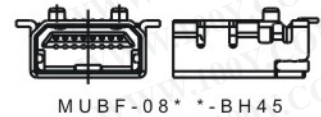
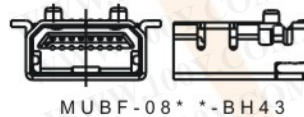
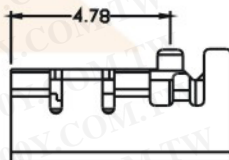
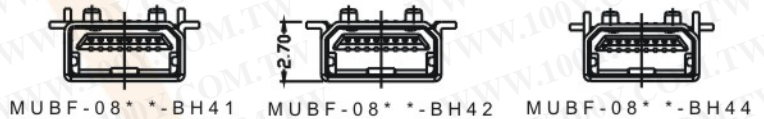

P.C.B LAYOUT