



# MIC2940A/2941A

## 1.25A Low-Dropout Voltage Regulator

### Preliminary Information

### General Description

The MIC2940A and MIC2941A are “bulletproof” efficient voltage regulators with very low dropout voltage (typically 40mV at light loads and 350mV at 1A), and low quiescent current (240 $\mu$ A typical). The quiescent current of the MIC2940A increases only slightly in dropout, thus prolonging battery life. Key MIC2940A features include protection against reversed battery, fold-back current limiting, and automotive “load dump” protection (60V positive transient).

The MIC2940 is available in both fixed voltage (3.3V, 5V, and 12V) and adjustable voltage configurations. The MIC2940A-xx devices are three pin fixed voltage regulators. A logic-compatible shutdown input is provided on the adjustable MIC2941A, which enables the regulator to be switched on and off.

勝特力材料 886-3-5753170  
勝特力电子(上海) 86-21-54151736  
勝特力电子(深圳) 86-755-83298787  
[Http://www.100y.com.tw](http://www.100y.com.tw)

### Features

- High output voltage accuracy
- Guaranteed 1.25A output
- Low quiescent current
- Low dropout voltage
- Extremely tight load and line regulation
- Very low temperature coefficient
- Current and thermal limiting
- Input can withstand -20V reverse battery and +60V positive transients
- Logic-controlled electronic shutdown
- Output programmable from 1.24V to 26V(MIC2941A)
- Available in TO-220, TO-263, TO-220-5, and TO-263-5 packages.

### Applications

- Battery Powered Equipment
- Cellular Telephones
- Laptop, Notebook, and Palmtop Computers
- PCMCIA  $V_{CC}$  and  $V_{PP}$  Regulation/Switching
- Bar Code Scanners
- Automotive Electronics
- SMPS Post-Regulator/ DC to DC Modules
- Voltage Reference
- High Efficiency Linear Power Supplies

### Pin Configuration

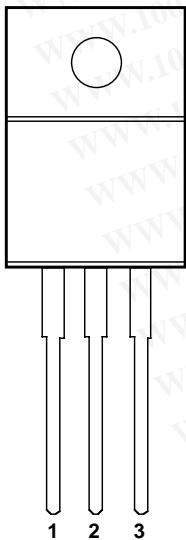

INPUT GROUND OUTPUT  
TO-220 Package  
(MIC2940A-xxBT)

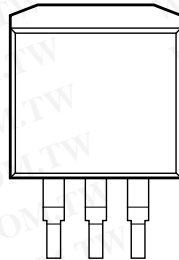

INPUT GROUND OUTPUT  
TO-263 Package  
(MIC2940A-xxBU)

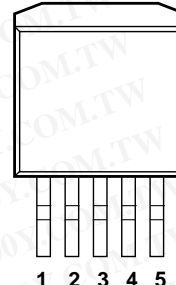

TO-263-5 Package  
(MIC2941ABU)

#### MIC2941A Pinout

- 1) Adjust
- 2) Shutdown
- 3) Ground
- 4) Input
- 5) Output

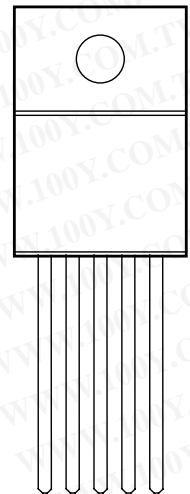

TO-220-5 Package  
(MIC2941ABT)

The Tab is Ground on TO-220 and TO-263 packages

### Absolute Maximum Ratings

If Military/Aerospace specified devices are required, contact your local Micrel representative/distributor for availability and specifications.

Power Dissipation (Note 1) ..... Internally Limited  
 Lead Temperature (Soldering, 5 seconds) ..... 260°C  
 Storage Temperature Range ..... -65°C to +150°C  
 Operating Junction Temperature Range ..... -40°C to +125°C  
 TO-220  $\theta_{JC}$  ..... 2 °C/W  
 TO-263  $\theta_{JC}$  ..... 2 °C/W  
 Input Supply Voltage ..... -20V to +60V  
 Operating Input Supply Voltage ..... 2V<sup>†</sup> to 26V  
 Adjust Input Voltage (Notes 9 and 10) ..... -1.5V to +26V  
 Shutdown Input Voltage ..... -0.3V to +30V  
 Error Comparator Output Voltage ..... -0.3V to +30V

Ordering Information			
Part Number	Voltage	Temperature Range*	Package
MIC2940A-3.3BT	3.3	-40°C to +125°C	TO-220
MIC2940A-3.3BU	3.3	-40°C to +125°C	TO-263
MIC2940A-5.0BT	5.0	-40°C to +125°C	TO-220
MIC2940A-5.0BU	5.0	-40°C to +125°C	TO-263
MIC2940A-12BT	12	-40°C to +125°C	TO-220
MIC2940A-12BU	12	-40°C to +125°C	TO-263
MIC2941ABT	Adj	-40°C to +125°C	TO-220-5
MIC2941ABU	Adj	-40°C to +125°C	TO-263-5

\* Junction temperatures

<sup>†</sup> Across the full operating temperature, the minimum input voltage range for full output current is 4.3V to 26V. Output will remain in-regulation at lower output voltages and low current loads down to an input of 2V at 25°C.

勝特力材料 886-3-5753170  
 勝特力电子(上海) 86-21-54151736  
 勝特力电子(深圳) 86-755-83298787  
[Http://www.100y.com.tw](http://www.100y.com.tw)

### Schematic Diagram

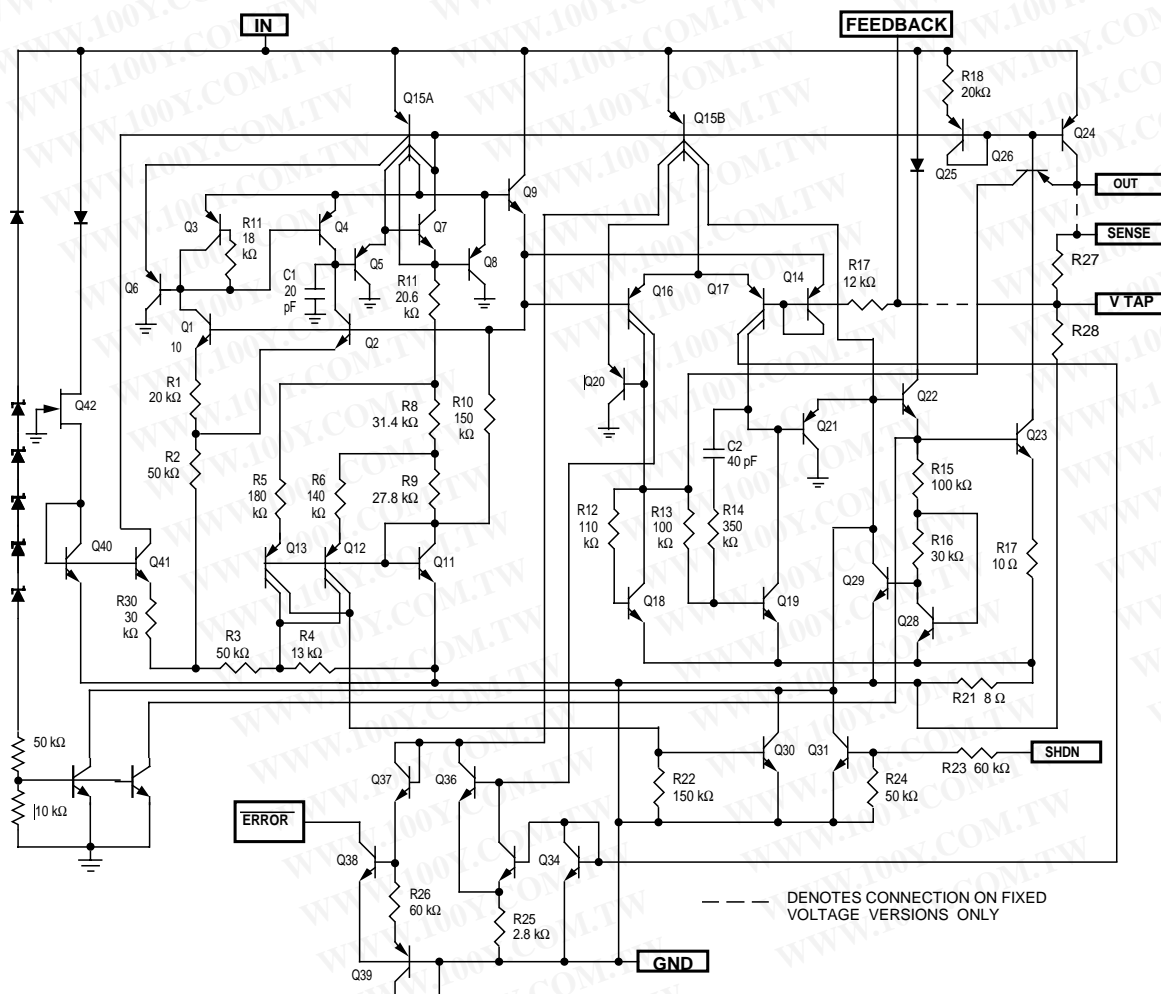

## Electrical Characteristics

Limits in standard typeface are for  $T_J = 25^\circ\text{C}$  and limits in **boldface** apply over the full operating temperature range. Unless otherwise specified,  $V_{IN} = V_{OUT} + 1\text{V}$ ,  $I_L = 1000\text{mA}$ ,  $C_L = 10\mu\text{F}$ . The MIC2941A is programmed to output 5V and has  $V_{SHUTDOWN} \leq 0.6\text{V}$ .

Symbol	Parameter	Conditions	Min	Typical	Max	Units
$V_o$	Output Voltage Accuracy		-1		1	%
			-2		2	
		$5\text{ mA} \leq I_L \leq 1\text{A}$	-2.5		2.5	
$\frac{\Delta V_o}{\Delta T}$	Output Voltage Temperature Coef.	(Note 2)		20	100	ppm/ $^\circ\text{C}$
$\frac{\Delta V_o}{V_o}$	Line Regulation	$V_{IN} = V_{OUT} + 1\text{V}$ to 26V		0.03	0.10	%
					<b>0.40</b>	
$\frac{\Delta V_o}{V_o}$	Load Regulation	$I_L = 5\text{mA}$ to 1.25A		0.04	0.16	%
		$I_L = 5\text{mA}$ to 1A (Note 3)			<b>0.20</b>	%
$V_{IN} - V_o$	Dropout Voltage (Note 4)	$I_L = 5\text{mA}$		60	150	mV
		$I_L = 250\text{mA}$		200	250	
		$I_L = 1000\text{mA}$		350	450	
		$I_L = 1250\text{mA}$		400	600	
$I_{GND}$	Ground Pin Current (Note 5)	$I_L = 5\text{mA}$		240	350	$\mu\text{A}$
		$I_L = 250\text{mA}$		3	4.5	mA
		$I_L = 1000\text{mA}$		22	35	
		$I_L = 1250\text{mA}$		35	70	
$I_{GNDDO}$	Ground Pin Current at Dropout (Note 5)	$V_{IN} = 0.5\text{V}$ less than designed $V_{OUT}$ ( $V_{OUT} \geq 3.3\text{V}$ ) $I_L = 5\text{mA}$		330	<b>600</b>	$\mu\text{A}$
$I_{LIMIT}$	Current Limit	$V_{OUT} = 0\text{V}$ (Note 6)		1.6	2.4	A
$\frac{\Delta V_o}{\Delta P_D}$	Thermal Regulation	(Note 7)		0.05	0.2	%/W
$e_n$	Output Noise Voltage (10Hz to 100kHz) $I_L = 100\text{mA}$	$C_L = 10\mu\text{F}$		400		$\mu\text{V RMS}$
		$C_L = 33\mu\text{F}$		260		

**Electrical Characteristics (MIC2941A Only)**

Parameter	Conditions	Min	Typical	Max	Units
Reference Voltage		1.223 <b>1.210</b>	1.235	1.247 <b>1.260</b>	V V max
Reference Voltage	(Note 8)	<b>1.204</b>		<b>1.266</b>	V
Adjust Pin Bias Current			20	40 <b>60</b>	nA
Reference Voltage Temperature Coefficient			20		ppm/°C
Adjust Pin Bias Current Temperature Coefficient			0.1		nA/°C

勝特力材料 886-3-5753170  
 勝特力电子(上海) 86-21-54151736  
 勝特力电子(深圳) 86-755-83298787  
[Http://www.100y.com.tw](http://www.100y.com.tw)

**Shutdown Input**

Input Logic Voltage	Low (ON) High (OFF)	<b>2.0</b>	1.3	<b>0.7</b>	V
Shutdown Pin Input Current	$V_{SHUTDOWN} = 2.4V$		30	50 <b>100</b>	$\mu A$
	$V_{SHUTDOWN} = 26V$		450	600 <b>750</b>	$\mu A$
Regulator Output Current in Shutdown	(Note 10)		3	30 <b>60</b>	$\mu A$

**Note 1:** Absolute maximum ratings indicate limits beyond which damage to the component may occur. Electrical specifications do not apply when operating the device outside of its rated operating conditions. The maximum allowable power dissipation is a function of the maximum junction temperature,  $T_{J(MAX)}$ , the junction-to-ambient thermal resistance,  $\theta_{JA}$ , and the ambient temperature,  $T_A$ . The maximum allowable power dissipation at any ambient temperature is calculated using:  $P_{J(MAX)} = (T_{J(MAX)} - T_A) / \theta_{JA}$ . Exceeding the maximum allowable power dissipation will result in excessive die temperature, and the regulator will go into thermal shutdown.

**Note 2:** Output voltage temperature coefficient is defined as the worst case voltage change divided by the total temperature range.

**Note 3:** Regulation is measured at constant junction temperature using low duty cycle pulse testing. Changes in output voltage due to heating effects are covered by the thermal regulation specification.

**Note 4:** Dropout Voltage is defined as the input to output differential at which the output voltage drops 100 mV below its nominal value measured at 1V differential. At low values of programmed output voltage, the minimum input supply voltage of 4.3V over temperature must be taken into account.

**Note 5:** Ground pin current is the regulator quiescent current. The total current drawn from the source is the sum of the load current plus the ground pin current.

**Note 6:** The MIC2940A features fold-back current limiting. The short circuit ( $V_{OUT} = 0V$ ) current limit is less than the maximum current with normal output voltage.

**Note 7:** Thermal regulation is defined as the change in output voltage at a time T after a change in power dissipation is applied, excluding load or line regulation effects. Specifications are for a 200mA load pulse at  $V_{IN} = 20V$  (a 4W pulse) for  $T = 10ms$ .

**Note 8:**  $V_{REF} \leq V_{OUT} \leq (V_{IN} - 1V)$ ,  $4.3V \leq V_{IN} \leq 26V$ ,  $5mA < I_L \leq 1.25A$ ,  $T_J \leq T_{JMAX}$ .

**Note 9:** Circuit of Figure 3 with  $R1 \geq 150k\Omega$ .  $V_{SHUTDOWN} \geq 2V$  and  $V_{IN} \leq 26V, V_{OUT} = 0$ .

**Note 10:** When used in dual supply systems where the regulator load is returned to a negative supply, the output voltage must be diode clamped to ground.

**Note 11:** Maximum positive supply voltage of 60 V must be of limited duration ( $< 100ms$ ) and duty cycle ( $\leq 1\%$ ). The maximum continuous supply voltage is 26V.

Typical Characteristics

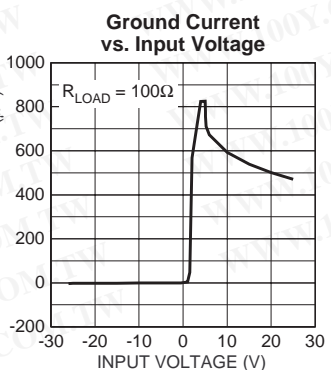
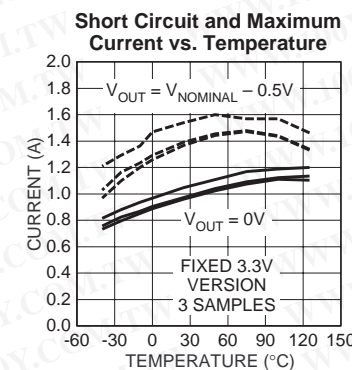
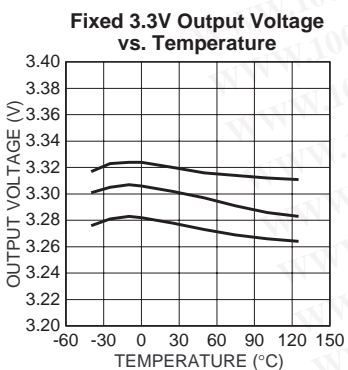
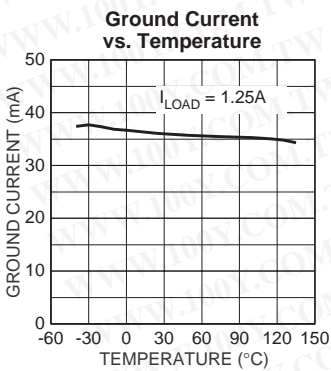
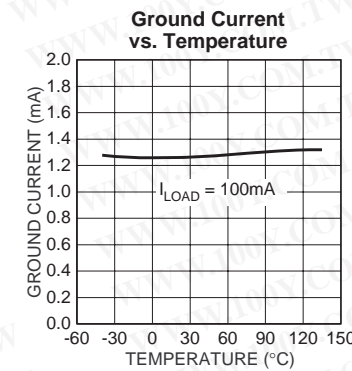
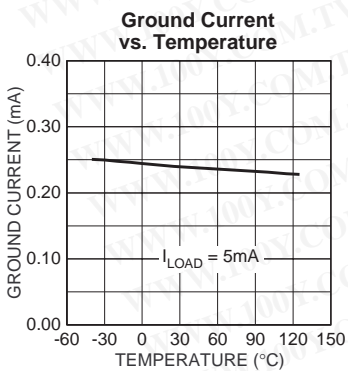
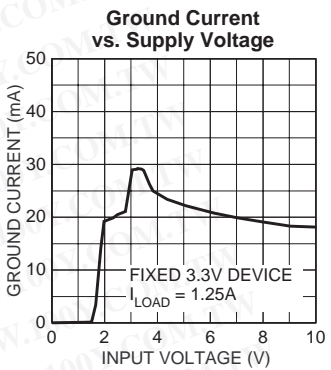
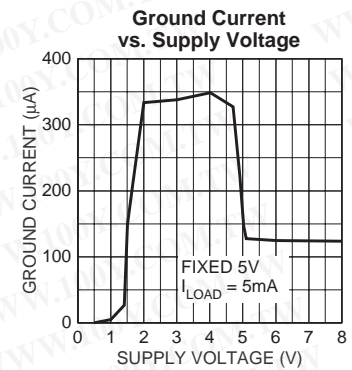
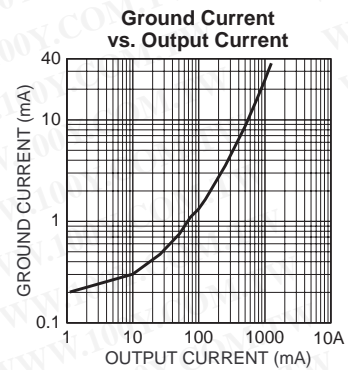
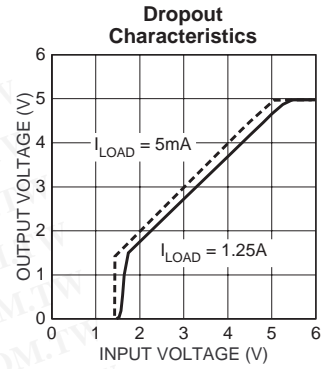
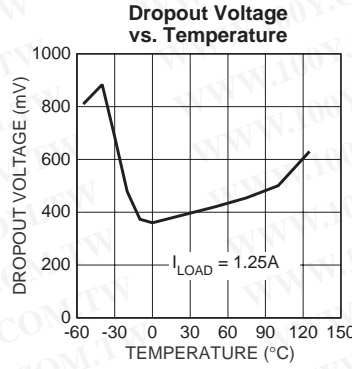
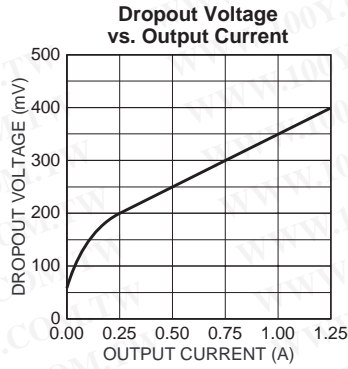

**MIC29401/2 Shutdown Current vs. Temperature**

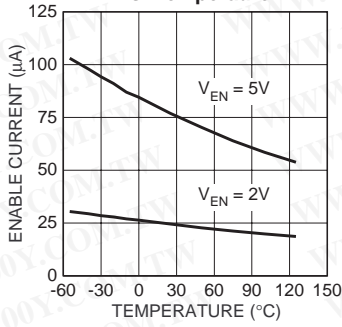

**Load Transient**

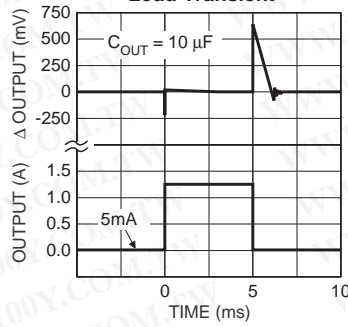

**Load Transient**

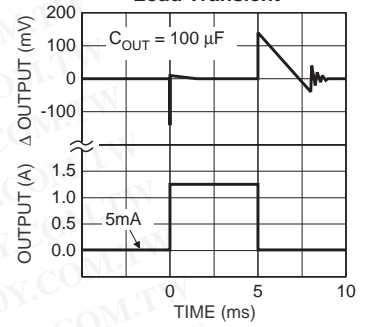

**MIC29402/3 Adjust Pin Current vs. Temperature**

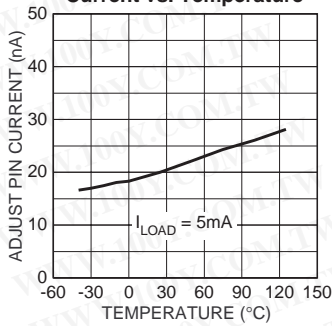

**Line Transient**

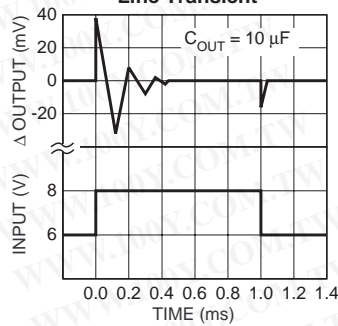

**Line Transient**

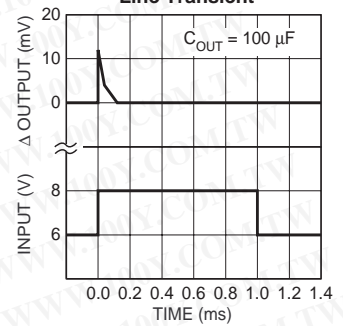

**Output Impedance vs. Frequency**

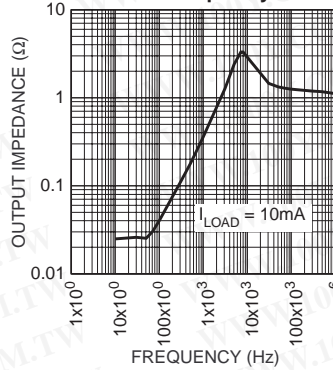

勝特力材料 886-3-5753170  
 勝特力电子(上海) 86-21-54151736  
 勝特力电子(深圳) 86-755-83298787  
[Http://www.100y.com.tw](http://www.100y.com.tw)

## Applications Information

### External Capacitors

A 10 $\mu$ F (or greater) capacitor is required between the MIC2940A output and ground to prevent oscillations due to instability. Most types of tantalum or aluminum electrolytics will be adequate; film types will work, but are costly and therefore not recommended. Many aluminum electrolytics have electrolytes that freeze at about  $-30^{\circ}\text{C}$ , so solid tantalums are recommended for operation below  $-25^{\circ}\text{C}$ . The important parameters of the capacitor are an effective series resistance of about 5 $\Omega$  or less and a resonant frequency above 500kHz. The value of this capacitor may be increased without limit.

At lower values of output current, less output capacitance is required for output stability. The capacitor can be reduced to 3.3 $\mu$ F for current below 100mA or 2.2 $\mu$ F for currents below 10 mA. Adjusting the MIC2941A to voltages below 5V runs the error amplifier at lower gains so that more output capacitance is needed. For the worst-case situation of a 1.25A load at 1.23V output (Output shorted to Adjust) a 22 $\mu$ F (or greater) capacitor should be used.

The MIC2940A will remain stable and in regulation with load currents ranging from 5mA on up to the full 1.25A rating. The external resistors of the MIC2941A version may be scaled to draw this minimum load current.

A 0.22 $\mu$ F capacitor should be placed from the MIC2940A input to ground if there is more than 10 inches of wire between the input and the AC filter capacitor or if a battery is used as the input.

### Programming the Output Voltage (MIC2941A)

The MIC2941A may be programmed for any output voltage between its 1.235V reference and its 26V maximum rating. An external pair of resistors is required, as shown in Figure 3.

The complete equation for the output voltage is

$$V_{\text{OUT}} = V_{\text{REF}} \times \{ 1 + R_1/R_2 \} - |I_{\text{FB}}| R_1$$

where  $V_{\text{REF}}$  is the nominal 1.235 reference voltage and  $I_{\text{FB}}$  is the Adjust pin bias current, nominally 20nA. The minimum recommended load current of 1  $\mu$ A forces an upper limit of 1.2M $\Omega$  on the value of  $R_2$ , if the regulator must work with no load (a condition often found in CMOS in standby),  $I_{\text{FB}}$  will produce a  $-2\%$  typical error in  $V_{\text{OUT}}$  which may be eliminated at room temperature by trimming  $R_1$ . For better accuracy, choosing  $R_2 = 100\text{k}\Omega$  reduces this error to 0.17% while increasing the resistor program current to 12  $\mu$ A. Since the MIC2941A typically draws 100  $\mu$ A at no load with SHUTDOWN open-circuited, this is a negligible addition.

### Reducing Output Noise

In reference applications it may be advantageous to reduce the AC noise present at the output. One method is to reduce the regulator bandwidth by increasing the size of the output capacitor. This is relatively inefficient, as increasing the capacitor from 1  $\mu$ F to 220  $\mu$ F only decreases the noise from 430 $\mu$ V to 160 $\mu$ V<sub>RMS</sub> for a 100kHz bandwidth at 5V output. Noise can be reduced by a factor of four with the MIC2941A by adding a bypass capacitor across  $R_1$ , since it reduces the high frequency gain from 4 to unity. Pick

$$C_{\text{BYPASS}} \cong \frac{1}{2\pi R_1 \cdot 200 \text{ Hz}}$$

or about 0.01  $\mu$ F. When doing this, the output capacitor must be increased to 22  $\mu$ F to maintain stability. These changes reduce the output noise from 430  $\mu$ V to 100  $\mu$ V rms for a 100 kHz bandwidth at 5V output. With the bypass capacitor added, noise no longer scales with output voltage so that improvements are more dramatic at higher output voltages.

### Automotive Applications

The MIC2940A is ideally suited for automotive applications for a variety of reasons. It will operate over a wide range of input voltages with very low dropout voltages (40mV at light loads), and very low quiescent currents (240 $\mu$ A typical). These features are necessary for use in battery powered systems, such as automobiles. It is a "bulletproof" device with the ability to survive both reverse battery (negative transients up to 20V below ground), and load dump (positive transients up to 60V) conditions. A wide operating temperature range with low temperature coefficients is yet another reason to use these versatile regulators in automotive designs.

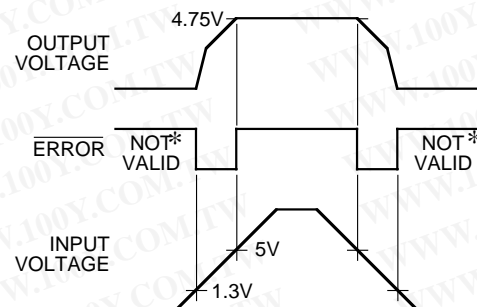

\* SEE APPLICATIONS INFORMATION

Figure 1. ERROR Output Timing

勝特力材料 886-3-5753170  
 勝特力电子(上海) 86-21-54151736  
 勝特力电子(深圳) 86-755-83298787  
 Http://www.100y.com.tw

# Typical Applications

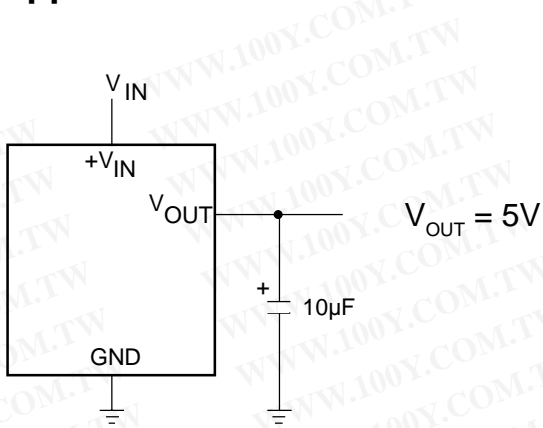

Figure 2. MIC2940A-5.0 Fixed +5V Regulator

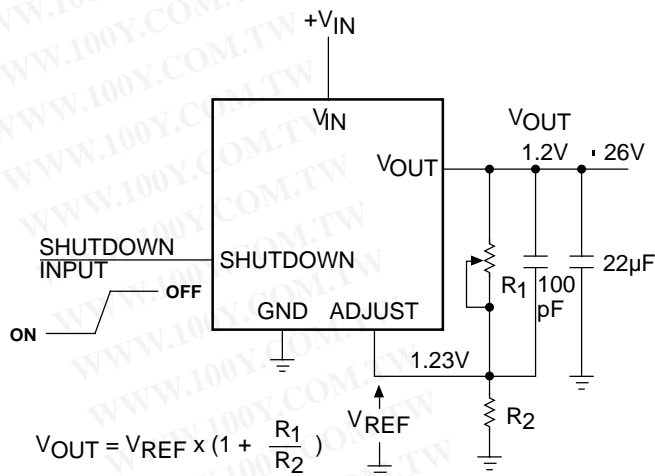
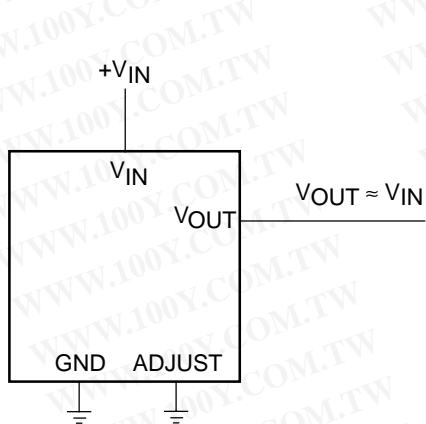
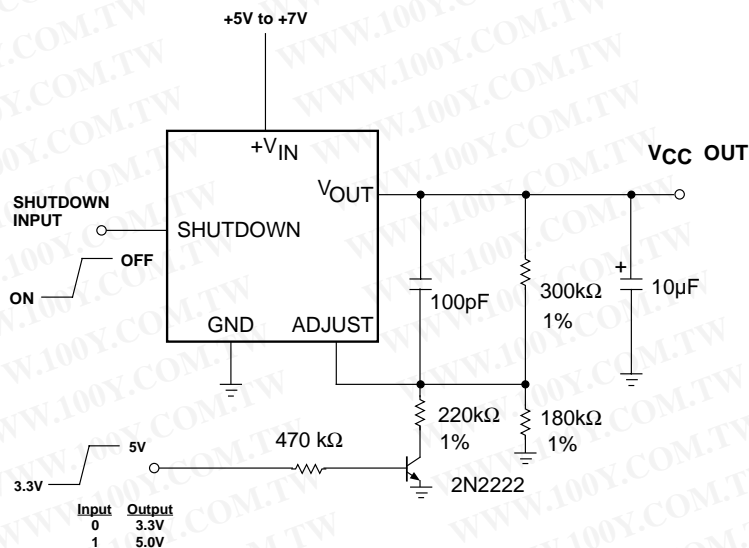

Figure 3. MIC2941A Adjustable Regulator



\*MINIMUM INPUT-OUTPUT VOLTAGE RANGES FROM 40mV TO 400mV, DEPENDING ON LOAD CURRENT.

Figure 4. MIC2941A Wide Input Voltage Range Current Limiter



ADJUST PIN LOW= ENABLE OUTPUT. Q1 ON = 3.3V, Q1 OFF = 5.0V.

Figure 5. MIC2941A 5.0V or 3.3V Selectable Regulator with Shutdown.

勝特力材料 886-3-5753170  
 勝特力电子(上海) 86-21-54151736  
 勝特力电子(深圳) 86-755-83298787  
[Http://www.100y.com.tw](http://www.100y.com.tw)