

MC14557B

1-to-64 Bit Variable Length Shift Register

The MC14557B is a static clocked serial shift register whose length may be programmed to be any number of bits between 1 and 64. The number of bits selected is equal to the sum of the subscripts of the enabled Length Control inputs (L1, L2, L4, L8, L16, and L32) plus one. Serial data may be selected from the A or B data inputs with the A/B select input. This feature is useful for recirculation purposes. A Clock Enable (CE) input is provided to allow gating of the clock or negative edge clocking capability.

The device can be effectively used for variable digital delay lines or simply to implement odd length shift registers.

- 1–64 Bit Programmable Length
- Q and \bar{Q} Serial Buffered Outputs
- Asynchronous Master Reset
- All Inputs Buffered
- No Limit On Clock Rise and Fall Times
- Supply Voltage Range = 3.0 Vdc to 18 Vdc
- Capable of Driving Two Low-power TTL Loads or one Low-power Schottky TTL Load Over the Rated Temperature Range
- Pb-Free Packages are Available

MAXIMUM RATINGS (Voltages Referenced to V_{SS})

Symbol	Parameter	Value	Unit
V_{DD}	DC Supply Voltage Range	-0.5 to +18.0	V
V_{in}, V_{out}	Input or Output Voltage Range (DC or Transient)	-0.5 to $V_{DD} + 0.5$	V
I_{in}, I_{out}	Input or Output Current (DC or Transient) per Pin	± 10	mA
P_D	Power Dissipation, per Package (Note 2)	500	mW
T_A	Ambient Temperature Range	-55 to +125	$^{\circ}\text{C}$
T_{stg}	Storage Temperature Range	-65 to +150	$^{\circ}\text{C}$
T_L	Lead Temperature (8-Second Soldering)	260	$^{\circ}\text{C}$

Maximum ratings are those values beyond which device damage can occur. Maximum ratings applied to the device are individual stress limit values (not normal operating conditions) and are not valid simultaneously. If these limits are exceeded, device functional operation is not implied, damage may occur and reliability may be affected.

1. V_{in} and V_{out} should be constrained to the range $V_{SS} \leq (V_{in} \text{ or } V_{out}) \leq V_{DD}$. Unused inputs must always be tied to an appropriate logic voltage level (e.g., either V_{SS} or V_{DD}). Unused outputs must be left open.
2. Temperature Derating:
 Plastic "P and D/DW" Packages: -7.0 mW/ $^{\circ}\text{C}$ From 65 $^{\circ}\text{C}$ To 125 $^{\circ}\text{C}$

*For additional information on our Pb-Free strategy and soldering details, please download the ON Semiconductor Soldering and Mounting Techniques Reference Manual, SOLDERRM/D.



ON Semiconductor®

http://onsemi.com

MARKING DIAGRAMS

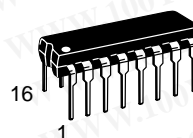

PDIP-16
 P SUFFIX
 CASE 648

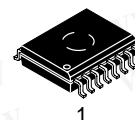
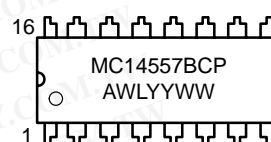

SO-16 WB
 DW SUFFIX
 CASE 751G

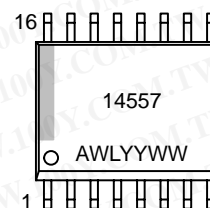

SOEIAJ-16
 F SUFFIX
 CASE 966

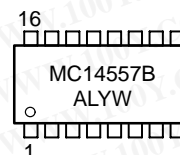

- A = Assembly Location
- WL, L = Wafer Lot
- YY, Y = Year
- WW, W = Work Week

ORDERING INFORMATION

See detailed ordering and shipping information in the package dimensions section on page 6 of this data sheet.

MC14557B

ELECTRICAL CHARACTERISTICS (Voltages Referenced to V_{SS})

Symbol	Characteristic	V_{DD} Vdc	- 55°C		25°C			125°C		Unit
			Min	Max	Min	Typ (Note 3)	Max	Min	Max	
V_{OL}	Output Voltage $V_{in} = V_{DD}$ or 0	"0" Level 5.0 10 15	-	0.05	-	0	0.05	-	0.05	Vdc
			-	0.05	-	0	0.05	-	0.05	
			-	0.05	-	0	0.05	-	0.05	
V_{OH}	$V_{in} = 0$ or V_{DD}	"1" Level 5.0 10 15	4.95	-	4.95	5.0	-	4.95	-	Vdc
			9.95	-	9.95	10	-	9.95	-	
			14.95	-	14.95	15	-	14.95	-	
V_{IL}	Input Voltage ($V_O = 4.5$ or 0.5 Vdc) ($V_O = 9.0$ or 1.0 Vdc) ($V_O = 13.5$ or 1.5 Vdc)	"0" Level 5.0 10 15	-	1.5	-	2.25	1.5	-	1.5	Vdc
			-	3.0	-	4.50	3.0	-	3.0	
			-	4.0	-	6.75	4.0	-	4.0	
V_{IH}	(V _O = 0.5 or 4.5 Vdc) (V _O = 1.0 or 9.0 Vdc) (V _O = 1.5 or 13.5 Vdc)	"1" Level 5.0 10 15	3.5	-	3.5	2.75	-	3.5	-	Vdc
			7.0	-	7.0	5.50	-	7.0	-	
			11	-	11	8.25	-	11	-	
I_{OH}	Output Drive Current ($V_{OH} = 2.5$ Vdc) ($V_{OH} = 4.6$ Vdc) ($V_{OH} = 9.5$ Vdc) ($V_{OH} = 13.5$ Vdc)	Source 5.0 5.0 10 15	-3.0	-	-2.4	-4.2	-	-1.7	-	mAdc
			-0.64	-	-0.51	-0.88	-	-0.36	-	
			-1.6	-	-1.3	-2.25	-	-0.9	-	
			-4.2	-	-3.4	-8.8	-	-2.4	-	
I_{OL}	(V _{OL} = 0.4 Vdc) (V _{OL} = 0.5 Vdc) (V _{OL} = 1.5 Vdc)	Sink 5.0 10 15	0.64	-	0.51	0.88	-	0.36	-	mAdc
			1.6	-	1.3	2.25	-	0.9	-	
			4.2	-	3.4	8.8	-	2.4	-	
I_{in}	Input Current	15	-	±0.1	-	±0.00001	±0.1	-	±1.0	μAdc
C_{in}	Input Capacitance ($V_{in} = 0$)	-	-	-	-	5.0	7.5	-	-	pF
I_{DD}	Quiescent Current (Per Package)	5.0	-	5.0	-	0.010	5.0	-	150	μAdc
		10	-	10	-	0.020	10	-	300	
		15	-	20	-	0.030	20	-	600	
I_T	Total Supply Current (Notes 4, 5) (Dynamic plus Quiescent, Per Package) ($C_L = 50$ pF on all outputs, all buffers switching)	5.0 10 15	$I_T = (1.75 \mu A/kHz) f + I_{DD}$ $I_T = (3.50 \mu A/kHz) f + I_{DD}$ $I_T = (5.25 \mu A/kHz) f + I_{DD}$							μAdc

3. Data labelled "Typ" is not to be used for design purposes but is intended as an indication of the IC's potential performance.

4. The formulas given are for the typical characteristics only at 25°C.

5. To calculate total supply current at loads other than 50 pF: $I_T(C_L) = I_T(50 \text{ pF}) + (C_L - 50) V_{fk}$ where: I_T is in μA (per package), C_L in pF, $V = (V_{DD} - V_{SS})$ in volts, f in kHz is input frequency, and $k = 0.001$.

勝特力材料 886-3-5753170
 勝特力电子(上海) 86-21-54151736
 勝特力电子(深圳) 86-755-83298787
[Http://www.100y.com.tw](http://www.100y.com.tw)

MC14557B

SWITCHING CHARACTERISTICS (Note 6) ($C_L = 50$ pF, $T_A = 25^\circ\text{C}$)

Symbol	Characteristic	V_{DD}	Min	Typ (Note 7)	Max	Unit
t_{TLH} , t_{THL}	Rise and Fall Time, Q or \bar{Q} Output $t_{TLH}, t_{THL} = (1.5 \text{ ns/pF}) C_L + 25 \text{ ns}$ $t_{TLH}, t_{THL} = (0.75 \text{ ns/pF}) C_L + 12.5 \text{ ns}$ $t_{TLH}, t_{THL} = (0.55 \text{ ns/pF}) C_L + 9.5 \text{ ns}$	5 10 15	– – –	100 50 40	200 100 80	ns
t_{PLH} , t_{PHL}	Propagation Delay, Clock or \bar{CE} to Q or \bar{Q} $t_{PLH}, t_{PHL} = (1.7 \text{ ns/pF}) C_L + 215 \text{ ns}$ $t_{PLH}, t_{PHL} = (0.66 \text{ ns/pF}) C_L + 97 \text{ ns}$ $t_{PLH}, t_{PHL} = (0.5 \text{ ns/pF}) C_L + 65 \text{ ns}$	5 10 15	– – –	300 130 90	600 260 180	ns
t_{PLH} , t_{PHL}	Propagation Delay, Reset to Q or \bar{Q} $t_{PLH}, t_{PHL} = (1.7 \text{ ns/pF}) C_L + 215 \text{ ns}$ $t_{PLH}, t_{PHL} = (0.66 \text{ ns/pF}) C_L + 97 \text{ ns}$ $t_{PLH}, t_{PHL} = (0.5 \text{ ns/pF}) C_L + 70 \text{ ns}$	5 10 15	– – –	300 130 95	600 260 190	ns
$t_{WH(cl)}$	Pulse Width, Clock	5 10 15	200 100 75	95 45 35	– – –	ns
$t_{WH(rst)}$	Pulse Width, Reset	5 10 15	300 140 100	150 70 50	– – –	ns
f_{cl}	Clock Frequency (50% Duty Cycle)	5 10 15	– – –	3.0 7.5 13.0	1.7 5.0 6.7	MHz
t_{su}	Setup Time, A or B to Clock or \bar{CE} Worst case condition: $L1 = L2 = L4 = L8 = L16 = L32 = V_{SS}$ (Register Length = 1) Best case condition: $L32 = V_{DD}$, L1 through L16 = Don't Care (Any register length from 33 to 64)	5 10 15 5 10 15	700 290 145 400 165 60	350 130 85 45 5 0	– – – – – –	ns
t_h	Hold Time, Clock or \bar{CE} to A or B Best case condition: $L1 = L2 = L4 = L8 = L16 = L32 = V_{SS}$ (Register Length = 1) Worst case condition: $L32 = V_{DD}$, L1 through L16 = Don't Care (Any register length from 33 to 64)	5 10 15 5 10 15	200 100 10 400 185 85	–150 –60 –50 50 25 22	– – – – – –	ns
t_r , t_f	Rise and Fall Time, Clock	5 10 15	No Limit			–
t_r , t_f	Rise and Fall Time, Reset or \bar{CE}	5 10 15	– – –	– – –	15 5 4	μs
t_{rem}	Removal Time, Reset to Clock or \bar{CE}	5 10 15	160 80 70	80 40 35	– – –	ns

6. The formulas given are for the typical characteristics only at 25°C .

7. Data labelled "Typ" is not to be used for design purposes but is intended as an indication of the IC's potential performance.

勝特力材料 886-3-5753170
勝特力电子(上海) 86-21-54151736
勝特力电子(深圳) 86-755-83298787
[Http://www.100y.com.tw](http://www.100y.com.tw)

MC14557B

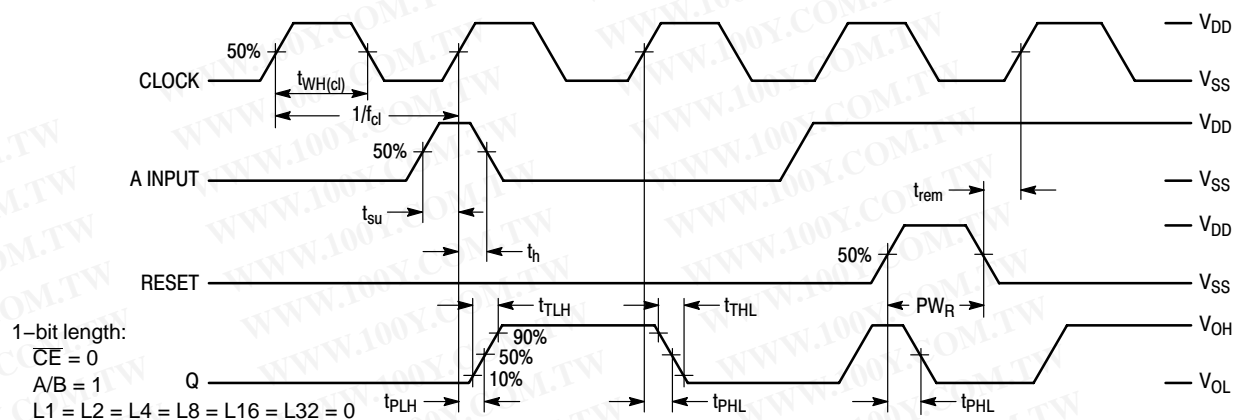

Figure 4. Timing Diagram

ORDERING INFORMATION

Device	Package	Shipping†
MC14557BF	SOEIAJ-16 (Pb-Free)	50 Units / Rail
MC14557BCP	PDIP-16	500 Units / Rail
MC14557BFEL	SOEIAJ-16 (Pb-Free)	2000 / Tape & Reel
MC14557BDWR2	SO-16 (WB)	1000 / Tape & Reel
MC14557BCPG	PDIP-16 (Pb-Free)	500 Units / Rail
MC14557BDW	SO-16 (WB)	47 Units / Rail

†For information on tape and reel specifications, including part orientation and tape sizes, please refer to our Tape and Reel Packaging Specifications Brochure, BRD8011/D.

勝特力材料 886-3-5753170
 勝特力电子(上海) 86-21-54151736
 勝特力电子(深圳) 86-755-83298787
[Http://www.100y.com.tw](http://www.100y.com.tw)

MC14557B

PACKAGE DIMENSIONS

PDIP-16
P SUFFIX
CASE 648-08
ISSUE T

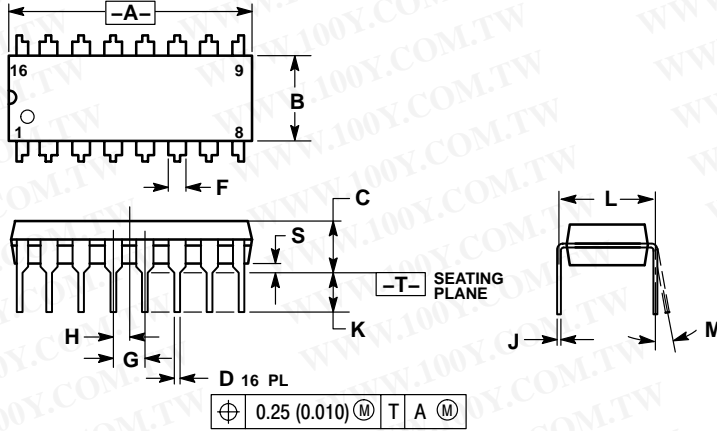

NOTES:

1. DIMENSIONING AND TOLERANCING PER ANSI Y14.5M, 1982.
2. CONTROLLING DIMENSION: INCH.
3. DIMENSION L TO CENTER OF LEADS WHEN FORMED PARALLEL.
4. DIMENSION B DOES NOT INCLUDE MOLD FLASH.
5. ROUNDED CORNERS OPTIONAL.

DIM	INCHES		MILLIMETERS	
	MIN	MAX	MIN	MAX
A	0.740	0.770	18.80	19.55
B	0.250	0.270	6.35	6.85
C	0.145	0.175	3.69	4.44
D	0.015	0.021	0.39	0.53
F	0.040	0.70	1.02	1.77
G	0.100 BSC		2.54 BSC	
H	0.050 BSC		1.27 BSC	
J	0.008	0.015	0.21	0.38
K	0.110	0.130	2.80	3.30
L	0.295	0.305	7.50	7.74
M	0° 10°		0° 10°	
S	0.020	0.040	0.51	1.01

SO-16 WB
DW SUFFIX
CASE 751G-03
ISSUE C

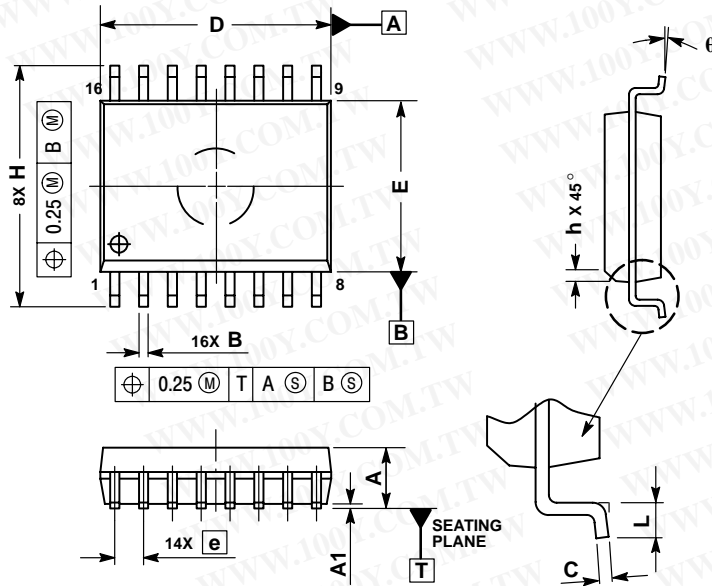

NOTES:

1. DIMENSIONS ARE IN MILLIMETERS.
2. INTERPRET DIMENSIONS AND TOLERANCES PER ASME Y14.5M, 1994.
3. DIMENSIONS D AND E DO NOT INCLUDE MOLD PROTRUSION.
4. MAXIMUM MOLD PROTRUSION 0.15 PER SIDE.
5. DIMENSION B DOES NOT INCLUDE DAMBAR PROTRUSION. ALLOWABLE DAMBAR PROTRUSION SHALL BE 0.13 TOTAL IN EXCESS OF THE B DIMENSION AT MAXIMUM MATERIAL CONDITION.

DIM	MILLIMETERS	
	MIN	MAX
A	2.35	2.65
A1	0.10	0.25
B	0.35	0.49
C	0.23	0.32
D	10.15	10.45
E	7.40	7.60
e	1.27 BSC	
H	10.05	10.55
h	0.25	0.75
L	0.50	0.90
q	0° 7°	

勝特力材料 886-3-5753170
 勝特力电子(上海) 86-21-54151736
 勝特力电子(深圳) 86-755-83298787
[Http://www.100y.com.tw](http://www.100y.com.tw)

MC14557B

PACKAGE DIMENSIONS

SOEIAJ-16
F SUFFIX
CASE 966-01
ISSUE O

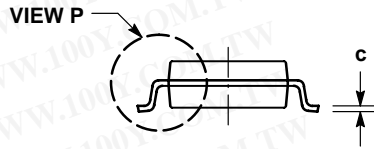
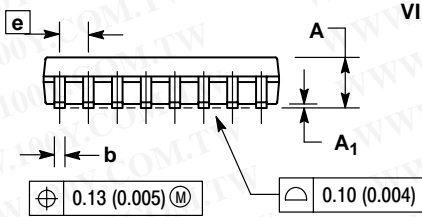
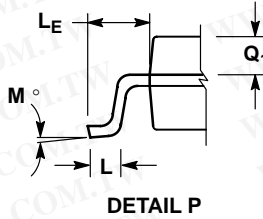
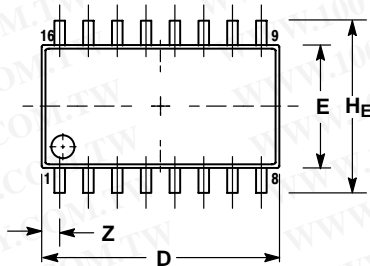

NOTES:

1. DIMENSIONING AND TOLERANCING PER ANSI Y14.5M, 1982.
2. CONTROLLING DIMENSION: MILLIMETER.
3. DIMENSIONS D AND E DO NOT INCLUDE MOLD FLASH OR PROTRUSIONS AND ARE MEASURED AT THE PARTING LINE. MOLD FLASH OR PROTRUSIONS SHALL NOT EXCEED 0.15 (0.006) PER SIDE.
4. TERMINAL NUMBERS ARE SHOWN FOR REFERENCE ONLY.
5. THE LEAD WIDTH DIMENSION (b) DOES NOT INCLUDE DAMBAR PROTRUSION. ALLOWABLE DAMBAR PROTRUSION SHALL BE 0.08 (0.003) TOTAL IN EXCESS OF THE LEAD WIDTH DIMENSION AT MAXIMUM MATERIAL CONDITION. DAMBAR CANNOT BE LOCATED ON THE LOWER RADIUS OR THE FOOT. MINIMUM SPACE BETWEEN PROTRUSIONS AND ADJACENT LEAD TO BE 0.46 (0.018).

DIM	MILLIMETERS		INCHES	
	MIN	MAX	MIN	MAX
A	---	2.05	---	0.081
A ₁	0.05	0.20	0.002	0.008
b	0.35	0.50	0.014	0.020
c	0.18	0.27	0.007	0.011
D	9.90	10.50	0.390	0.413
E	5.10	5.45	0.201	0.215
e	1.27 BSC		0.050 BSC	
HE	7.40	8.20	0.291	0.323
L	0.50	0.85	0.020	0.033
LE	1.10	1.50	0.043	0.059
M	0°	10°	0°	10°
Q ₁	0.70	0.90	0.028	0.035
Z	---	0.78	---	0.031

勝特力材料 886-3-5753170
 勝特力电子(上海) 86-21-54151736
 勝特力电子(深圳) 86-755-83298787
[Http://www.100y.com.tw](http://www.100y.com.tw)

ON Semiconductor and  are registered trademarks of Semiconductor Components Industries, LLC (SCILLC). SCILLC reserves the right to make changes without further notice to any products herein. SCILLC makes no warranty, representation or guarantee regarding the suitability of its products for any particular purpose, nor does SCILLC assume any liability arising out of the application or use of any product or circuit, and specifically disclaims any and all liability, including without limitation special, consequential or incidental damages. "Typical" parameters which may be provided in SCILLC data sheets and/or specifications can and do vary in different applications and actual performance may vary over time. All operating parameters, including "Typicals" must be validated for each customer application by customer's technical experts. SCILLC does not convey any license under its patent rights nor the rights of others. SCILLC products are not designed, intended, or authorized for use as components in systems intended for surgical implant into the body, or other applications intended to support or sustain life, or for any other application in which the failure of the SCILLC product could create a situation where personal injury or death may occur. Should Buyer purchase or use SCILLC products for any such unintended or unauthorized application, Buyer shall indemnify and hold SCILLC and its officers, employees, subsidiaries, affiliates, and distributors harmless against all claims, costs, damages, and expenses, and reasonable attorney fees arising out of, directly or indirectly, any claim of personal injury or death associated with such unintended or unauthorized use, even if such claim alleges that SCILLC was negligent regarding the design or manufacture of the part. SCILLC is an Equal Opportunity/Affirmative Action Employer. This literature is subject to all applicable copyright laws and is not for resale in any manner.

PUBLICATION ORDERING INFORMATION

LITERATURE FULFILLMENT:
 Literature Distribution Center for ON Semiconductor
 P.O. Box 61312, Phoenix, Arizona 85082-1312 USA
Phone: 480-829-7710 or 800-344-3860 Toll Free USA/Canada
Fax: 480-829-7709 or 800-344-3867 Toll Free USA/Canada
Email: orderlit@onsemi.com

N. American Technical Support: 800-282-9855 Toll Free USA/Canada
Japan: ON Semiconductor, Japan Customer Focus Center
 2-9-1 Kamimeguro, Meguro-ku, Tokyo, Japan 153-0051
Phone: 81-3-5773-3850

ON Semiconductor Website: <http://onsemi.com>
Order Literature: <http://www.onsemi.com/litorder>
 For additional information, please contact your local Sales Representative.