

MAXIM

USB Current-Limited Switch in Pin-Compatible Package

MAX1607

General Description

The MAX1607 is a current-limited 60mΩ switch with built-in fault blanking. Its accurate, preset 0.7A to 1.0A current limit makes it ideal for USB applications. Its low quiescent supply current (14μA) and standby current (1μA) conserve battery power in portable applications. The MAX1607 operates with inputs from +2.7V to +5.5V, making it ideal for both 3V and 5V systems.

An overcurrent signal (\overline{OC}) notifies the microprocessor that the internal current limit has been reached. A 10ms overcurrent-blanking feature allows momentary faults (such as those caused when hot-swapping into a capacitive load) to be ignored, thus preventing false alarms to the host system. This blanking also prevents an \overline{OC} signal from being issued when the device is powering up.

The MAX1607 has several safety features to ensure that the USB port is protected. Built-in thermal-overload protection limits power dissipation and junction temperature. The device also has accurate internal current-limiting circuitry to protect the input supply against overload.

The MAX1607 is a pin-compatible upgrade to Texas Instruments' TPS2014, TPS2015, and TPS2041 for USB applications. The same die is available in a space-saving 10-pin μ MAX package (MAX1693) and can be used for next-generation designs. The MAX1694 is similar to the MAX1693, but it has a built-in latch that turns off the power switch in case of a long-term short-circuit condition.

Applications

Notebook Computers
 USB Ports
 USB Hubs
 Docking Stations

Pin Configuration

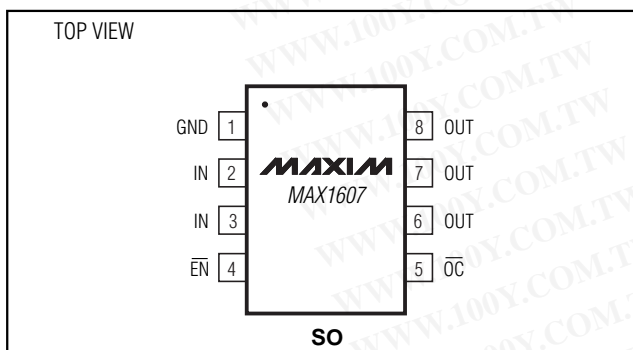

Features

- ◆ Pin Compatible with TPS2014, TPS2015, and TPS2041
- ◆ Accurate Current Limit (0.7A min, 1.0A max)
- ◆ Guaranteed 0.75A Short-Circuit Protection
- ◆ 10ms Internal \overline{OC} Blanking Timeout
- ◆ No Overcurrent (\overline{OC}) Signal During Power-Up
- ◆ 125mΩ max High-Side MOSFET
- ◆ 500mA Continuous Current
- ◆ Short-Circuit and Thermal Protection with Overcurrent Logic Output
- ◆ 1ms Start-Up Time
- ◆ Undervoltage Lockout
- ◆ 14μA Quiescent Supply Current
- ◆ 1μA max Standby Supply Current
- ◆ +2.7V to +5.5V Supply Range
- ◆ UL Recognition Pending

Ordering Information

PART	TEMP. RANGE	PIN-PACKAGE
MAX1607ESA	-40°C to +85°C	8 SO

Typical Operating Circuit

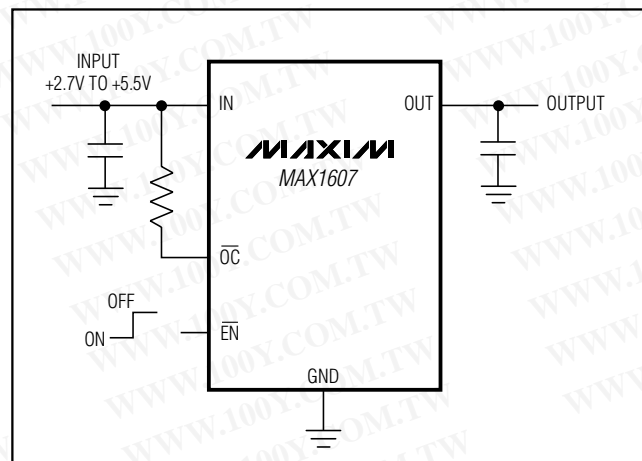

MAXIM

Maxim Integrated Products 1

For free samples & the latest literature: <http://www.maxim-ic.com>, or phone 1-800-998-8800.
 For small orders, phone 1-800-835-8769.

USB Current-Limited Switch in Pin-Compatible Package

MAX1607

ABSOLUTE MAXIMUM RATINGS

IN, \overline{EN} , \overline{OC} to GND	-0.3 to +6V	Continuous Power Dissipation ($T_A = +70^\circ\text{C}$)	
OUT to GND	-0.3V to ($V_{IN} + 0.3V$)	8-Pin SO (derate 5.88mW/ $^\circ\text{C}$ above $+70^\circ\text{C}$).....	471mW
Maximum Switch Current.....	1.2A (internally limited)	Operating Temperature Range (extended).....	-40°C to $+85^\circ\text{C}$
OUT Short-Circuit to GND	Continuous	Storage Temperature Range	-65°C to $+150^\circ\text{C}$
		Lead Temperature (soldering, 10sec)	$+300^\circ\text{C}$

Stresses beyond those listed under "Absolute Maximum Ratings" may cause permanent damage to the device. These are stress ratings only, and functional operation of the device at these or any other conditions beyond those indicated in the operational sections of the specifications is not implied. Exposure to absolute maximum rating conditions for extended periods may affect device reliability.

ELECTRICAL CHARACTERISTICS

($V_{IN} = +5V$, $T_A = 0^\circ\text{C}$ to $+85^\circ\text{C}$, unless otherwise noted. Typical values are at $T_A = +25^\circ\text{C}$.)

PARAMETER	SYMBOL	CONDITIONS	MIN	TYP	MAX	UNITS
OPERATING CONDITION						
Input Voltage	V_{IN}		2.7		5.5	V
POWER SWITCH						
Switch Static Drain-Source On-State Resistance	$R_{DS(ON)}$	$T_A = +25^\circ\text{C}$ $V_{IN} = 4.4V$ to $5.5V$		60	90	m Ω
		$T_A = 0^\circ\text{C}$ to $+85^\circ\text{C}$	$V_{IN} = 4.4V$ to $5.5V$		125	
			$V_{IN} = 3V$		72	
Switch Turn-On Time	t_{ON}	$I_{LOAD} = 400mA$		80	200	μs
Switch Turn-Off Time	t_{OFF}	$I_{LOAD} = 400mA$	3	6	20	μs
ENABLE INPUT (\overline{EN})						
\overline{EN} High-Level Input Voltage	V_{IH}	$V_{IN} = 2.7V$ to $3.6V$	2.0			V
		$V_{IN} = 3.7V$ to $5.5V$	2.4			
\overline{EN} Low-Level Input Voltage	V_{IL}	$V_{IN} = 2.7V$ to $5.5V$			0.8	V
\overline{EN} Input Current		$V_{\overline{EN}} = V_{IN}$ or GND	-1		1	μA
Start-Up Time		$V_{IN} = 5V$, $C_{OUT} = 150\mu\text{F}$ from \overline{EN} driven low to 50% full V_{OUT}		1		ms
CURRENT LIMIT						
Overload Output Current	I_{LIMIT}	Force V_{OUT} to 4.5V	700	850	1000	mA
Short-Circuit Output Current	I_{SC}	OUT shorted to GND		500	700	mA
SUPPLY CURRENT						
Supply Current, Low-Level Input		$V_{\overline{EN}} = V_{IN} = V_{OUT} = 5.5V$		0.001	1	μA
Supply Current, High-Level Input	I_Q	$V_{\overline{EN}} = \text{GND}$, $I_{OUT} = 0$	Timer not running	14	25	μA
			Timer running	35		
Supply Leakage Current		$V_{\overline{EN}} = V_{IN} = 5.5V$, $V_{OUT} = \text{GND}$	$T_A = +25^\circ\text{C}$	0.01	2	μA
			$T_A = 0^\circ\text{C}$ to $+85^\circ\text{C}$			
UNDERVOLTAGE LOCKOUT						
Undervoltage Lockout	UVLO	Rising edge, 100mV hysteresis	2.0	2.4	2.6	V
OVERCURRENT (OC)						
\overline{OC} Output Low Voltage	V_{OL}	$I_{SINK} = 1mA$, $V_{IN} = 3V$			0.4	V
\overline{OC} Off-State Current		$V_{IN} = V_{\overline{OC}} = 5V$			1	μA
\overline{OC} Blanking Timeout Period	t_{BL}	From overcurrent condition to \overline{OC} assertion	7	10	13	ms
THERMAL SHUTDOWN						
Thermal Shutdown Threshold				+165		$^\circ\text{C}$

USB Current-Limited Switch in Pin-Compatible Package

MAX1607

ELECTRICAL CHARACTERISTICS

($V_{IN} = +5V$, $T_A = -40^{\circ}C$ to $+85^{\circ}C$, unless otherwise noted.) (Note 1)

PARAMETER	SYMBOL	CONDITIONS	MIN	TYP	MAX	UNITS
OPERATING CONDITION						
Input Voltage	V_{IN}		3.0		5.5	V
POWER SWITCH						
Switch Static Drain-Source On-State Resistance	$R_{DS(ON)}$	$V_{IN} = 4.4V$ to $5.5V$			125	m Ω
		$V_{IN} = 3V$			150	
Switch Turn-On Time	t_{ON}	$I_{LOAD} = 400mA$			200	μs
Switch Turn-Off Time	t_{OFF}	$I_{LOAD} = 400mA$	1		20	μs
ENABLE INPUT (\overline{EN})						
\overline{EN} High-Level Input Voltage	V_{IH}	$V_{IN} = 3.0V$ to $3.6V$	2.0			V
		$V_{IN} = 3.7V$ to $5.5V$	2.4			
\overline{EN} Low-Level Input Voltage	V_{IL}	$V_{IN} = 3.0V$ to $5.5V$			0.8	V
\overline{EN} Input Current		$V_{\overline{EN}} = V_{IN}$ or GND	-1		1	μA
CURRENT LIMIT						
Overload Output Current	I_{LIMIT}	Force V_{OUT} to $4.5V$	640		1060	mA
Short-Circuit Output Current	I_{SC}	OUT shorted to GND			750	mA
SUPPLY CURRENT						
Supply Current, Low-Level Input		$V_{\overline{EN}} = V_{IN} = V_{OUT} = 5.5V$			2	μA
Supply Current, High-Level Input	I_Q	$V_{\overline{EN}} = GND$, $I_{OUT} = 0$, timer not running			25	μA
Supply Leakage Current		$V_{\overline{EN}} = V_{IN} = 5.5V$, $V_{OUT} = GND$			15	μA
UNDERVOLTAGE LOCKOUT						
Undervoltage Lockout	UVLO	Rising edge, 100mV hysteresis	2.0		2.9	V
OVERCURRENT (\overline{OC})						
\overline{OC} Output Low Voltage	V_{OL}	$I_{SINK} = 1mA$, $V_{IN} = 3V$			0.4	V
\overline{OC} Off-State Current		$V_{IN} = V_{\overline{OC}} = 5V$			1	μA
\overline{OC} Blanking Timeout Period	t_{BL}	From overcurrent condition to \overline{OC} assertion	6		14	ms

Note 1: Specifications to $-40^{\circ}C$ are guaranteed by design, not production tested.

勝特力材料 886-3-5753170
 勝特力电子(上海) 86-21-54151736
 勝特力电子(深圳) 86-755-83298787
[Http://www.100y.com.tw](http://www.100y.com.tw)

勝特力材料 886-3-5753170
 勝特力电子(上海) 86-21-54151736
 勝特力电子(深圳) 86-755-83298787
 Http://www.100y.com.tw

USB Current-Limited Switch in Pin-Compatible Package

Typical Operating Characteristics

($V_{IN} = +5V$, $T_A = +25^\circ C$, unless otherwise noted.)

QUIESCENT CURRENT vs. INPUT VOLTAGE

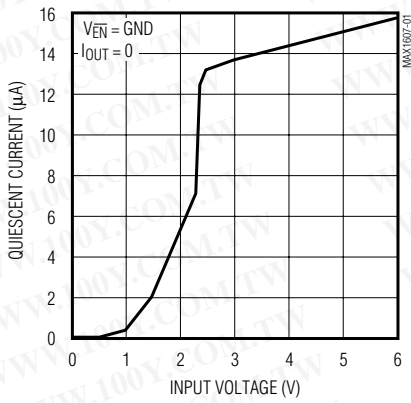

QUIESCENT CURRENT vs. TEMPERATURE

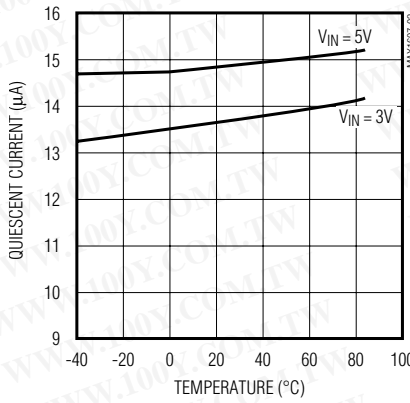

OFF SUPPLY CURRENT vs. TEMPERATURE

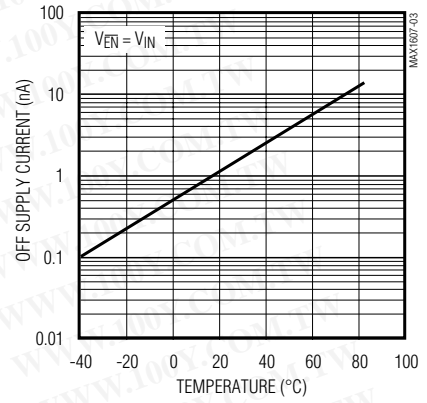

OFF SWITCH CURRENT vs. TEMPERATURE

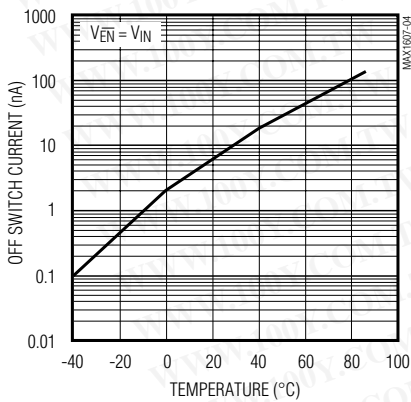

NORMALIZED ON-RESISTANCE vs. TEMPERATURE

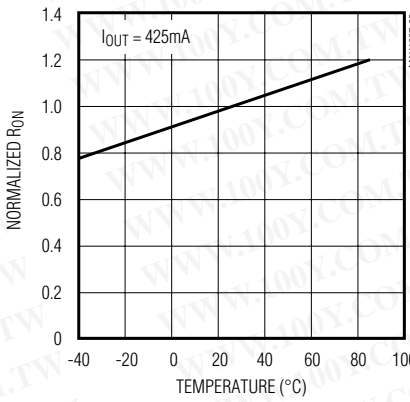

NORMALIZED OUTPUT CURRENT vs. OUTPUT VOLTAGE

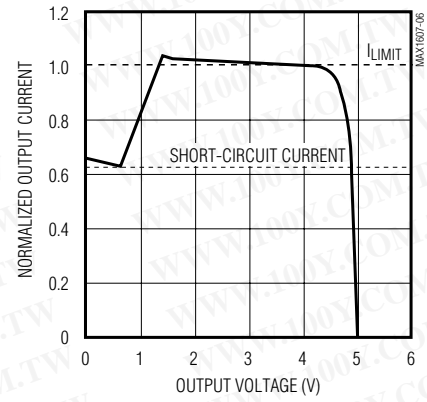

TURN-ON TIME vs. TEMPERATURE

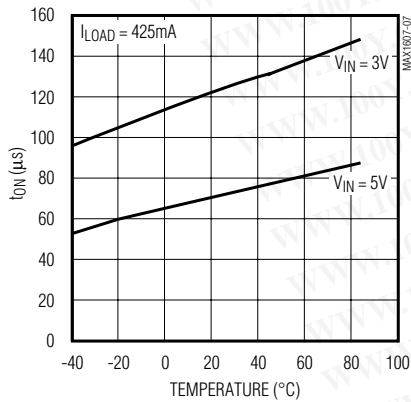

TURN-OFF TIME vs. TEMPERATURE

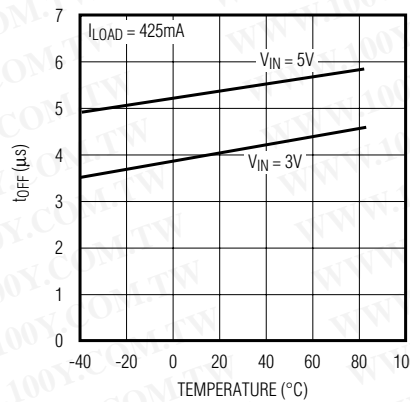

FAULT-BLANKING TIMEOUT vs. TEMPERATURE

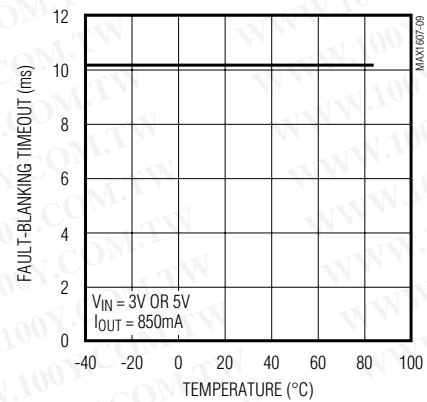

勝特力材料 886-3-5753170
 勝特力电子(上海) 86-21-54151736
 勝特力电子(深圳) 86-755-83298787
 Http://www.100y.com.tw

USB Current-Limited Switch in Pin-Compatible Package

Typical Operating Characteristics (continued)

($V_{IN} = +5V$, $T_A = +25^\circ C$, unless otherwise noted.)

MAX1607

CURRENT-LIMIT AND \overline{OC} RESPONSE

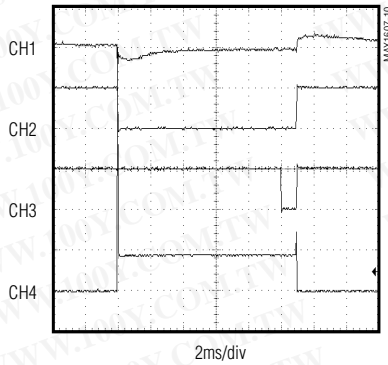

CH1 = V_{IN} , 200mV/div, AC-COUPLED
 CH2 = V_{OUT} , 5V/div
 CH3 = V_{OC} , 5V/div
 CH4 = I_{OUT} , 500mA/div

CURRENT-LIMIT RESPONSE

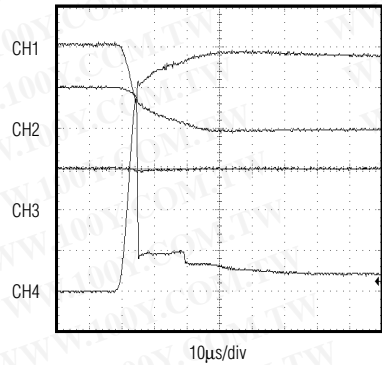

CH1 = V_{IN} , 200mV/div, AC-COUPLED
 CH2 = V_{OUT} , 5V/div
 CH3 = V_{OC} , 5V/div
 CH4 = I_{OUT} , 1A/div

SWITCH TURN-ON TIME

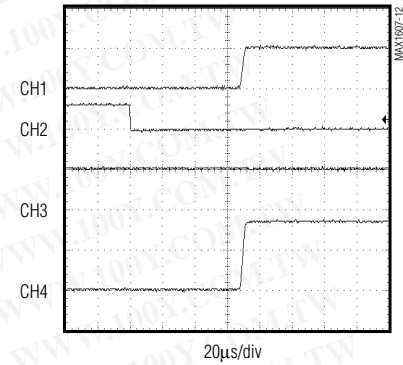

CH1 = V_{OUT} , 5V/div
 CH2 = V_{EN} , 5V/div
 CH3 = V_{OC} , 5V/div
 CH4 = I_{OUT} , 200mA/div

SWITCH TURN-OFF TIME

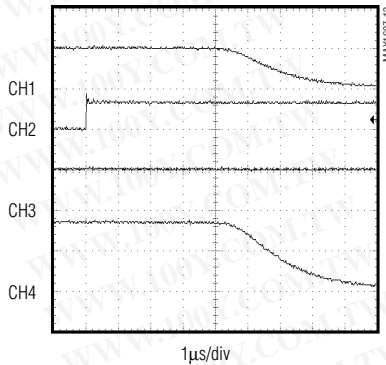

CH1 = V_{OUT} , 5V/div
 CH2 = V_{EN} , 5V/div
 CH3 = V_{OC} , 5V/div
 CH4 = I_{OUT} , 200mA/div

**START-UP TIME
(TYPICAL USB APPLICATION)**

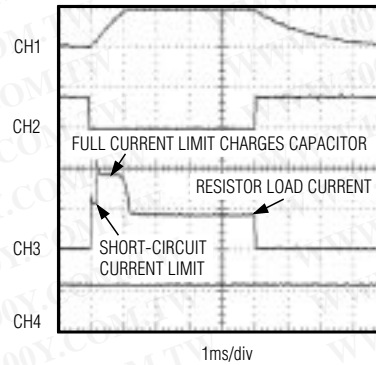

$V_{IN} = 5V$, $R_L = 15\Omega$, $C_L = 150\mu F$
 CH1 = V_{OUT} , 5V/div
 CH2 = V_{EN} , 5V/div
 CH3 = I_{IN} , 500mA/div
 CH4 = V_{OC} , 5V/div

USB Current-Limited Switch in Pin-Compatible Package

Pin Description

PIN	NAME	FUNCTION
1	GND	Ground
2, 3	IN	Input. P-channel MOSFET source—connect all IN pins together and bypass with a 1 μ F capacitor to ground.
4	$\overline{\text{EN}}$	Active-Low Switch Enable Input. A logic low turns on the switch.
5	$\overline{\text{OC}}$	Overcurrent-Indicator Output. This open-drain output goes low when the device is in thermal shutdown or undervoltage lockout, or during a sustained (>10ms) current-limit condition.
6, 7, 8	OUT	Switch Output. P-channel MOSFET drain—connect all OUT pins together and bypass with a 0.1 μ F capacitor to ground.

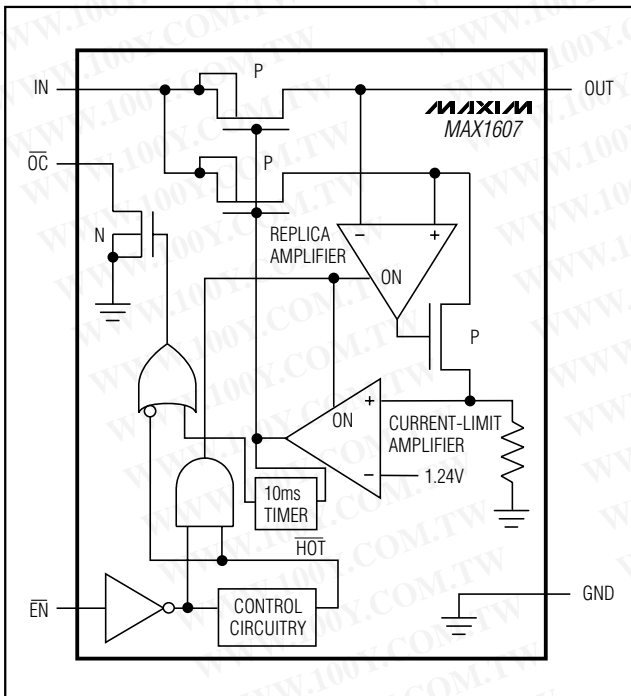

Figure 1. Functional Diagram

Detailed Description

The MAX1607 P-channel MOSFET power switch limits output current to 0.7A min and 1.0A max. When the output current is increased beyond the current limit (I_{LIMIT}), the current also increases through the replica switch ($I_{OUT} / 6500$). The current-limit error amplifier compares the voltage to the internal 1.24V reference and regulates the current back to the I_{LIMIT} (Figure 1).

These switches are not bidirectional; therefore, the input voltage must be higher than the output voltage.

Continuous Short-Circuit Protection

The MAX1607 is a short-circuit-protected switch. In the event of an output short-circuit condition, the current through the switch is foldback-current-limited to 500mA continuous.

Thermal Shutdown

The MAX1607 has a thermal shutdown feature. The switch turns off and the $\overline{\text{OC}}$ output goes low immediately (no overcurrent blanking) when the junction temperature exceeds +165°C. When the MAX1607 cools 20°C, the switch turns back on. If the fault short-circuit condition is not removed, the switch will cycle on and off, resulting in a pulsed output.

$\overline{\text{OC}}$ Indicator

The MAX1607 provides an overcurrent output ($\overline{\text{OC}}$). A 100k Ω pull-up resistor from $\overline{\text{OC}}$ to IN provides a logic control signal. This open-drain output goes low when any of the following conditions occur:

- The input voltage is below the 2.4V undervoltage-lockout (UVLO) threshold.
- The die temperature exceeds the thermal shutdown temperature limit of +165°C.
- The device is in current limit for greater than 10ms.

$\overline{\text{OC}}$ Blanking

The MAX1607 features 10ms overcurrent blanking. Blanking allows brief current-limit faults, including momentary short-circuit faults that occur when hot-swapping a capacitive load, and also ensures that no $\overline{\text{OC}}$ is issued during power-up. When a load transient causes the device to enter current limit, an internal counter starts. If the load fault persists beyond the 10ms overcurrent-blanking timeout, the $\overline{\text{OC}}$ output asserts low. Ensure that the MAX1607 input is adequately bypassed to prevent input glitches from triggering spurious $\overline{\text{OC}}$ outputs. Input voltage glitches less

USB Current-Limited Switch in Pin-Compatible Package

than 150mV will not cause a spurious \overline{OC} output. Load-transient faults less than 10ms (typ) will not cause an \overline{OC} output assertion.

Only current-limit faults are blanked. Die overtemperature faults and input voltage droops below the UVLO threshold will cause an immediate \overline{OC} output.

Applications Information

Input Capacitor

To limit the input voltage drop during momentary output short-circuit conditions, connect a capacitor from IN to GND. A 1 μ F ceramic capacitor will be adequate for most applications; however, higher capacitor values will further reduce the voltage drop at the input (Figure 2).

Output Capacitor

Connect a 0.1 μ F capacitor from OUT to GND. This capacitor helps to prevent inductive parasitics from pulling OUT negative during turn-off.

Layout and Thermal Dissipation

Important: Optimize the switch response time to output short-circuit conditions by keeping all traces as short as possible to reduce the effect of undesirable parasitic inductance. Place input and output capacitors as close as possible to the device (no more than 5mm away). All IN and OUT pins must be connected with short traces to the power bus. Wide power-bus planes will provide superior heat dissipation through the MAX1607's IN and OUT pins.

Under normal operating conditions, the package can dissipate and channel heat away. Calculate the maximum power dissipation as follows:

$$P = (I_{LIMIT})^2 \cdot R_{ON}$$

where I_{LIMIT} is the preset current limit (1.0A max) and R_{ON} is the on-resistance of the switch (125m Ω max).

When the output is short circuited, foldback-current limiting activates and the voltage drop across the switch equals the input supply. The power dissipated across the switch increases, as does the die temperature. If the fault condition is not removed, the thermal-overload-protection circuitry activates (see *Thermal Shutdown* section). Wide power-bus planes connected to IN and OUT and a ground plane in contact with the device will help dissipate additional heat.

Chip Information

TRANSISTOR COUNT: 715

勝特力材料 886-3-5753170
 勝特力电子(上海) 86-21-54151736
 勝特力电子(深圳) 86-755-83298787
[Http://www.100y.com.tw](http://www.100y.com.tw)

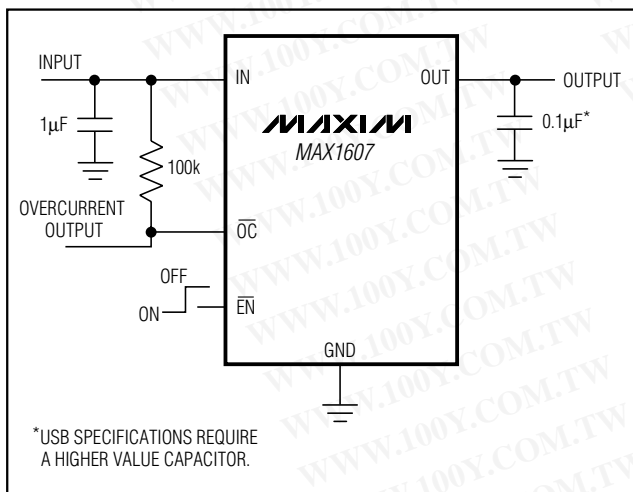

Figure 2. Typical Application Circuit

USB Current-Limited Switch in Pin-Compatible Package

勝特力材料 886-3-5753170
 勝特力电子(上海) 86-21-54151736
 勝特力电子(深圳) 86-755-83298787
[Http://www.100y.com.tw](http://www.100y.com.tw)

Package Information

	INCHES		MILLIMETERS	
	MIN	MAX	MIN	MAX
A	0.053	0.069	1.35	1.75
A1	0.004	0.010	0.10	0.25
B	0.014	0.019	0.35	0.49
C	0.007	0.010	0.19	0.25
e	0.050		1.27	
E	0.150	0.157	3.80	4.00
H	0.228	0.244	5.80	6.20
h	0.010	0.020	0.25	0.50
L	0.016	0.050	0.40	1.27

	INCHES		MILLIMETERS		N	MS012
	MIN	MAX	MIN	MAX		
D	0.189	0.197	4.80	5.00	8	A
D	0.337	0.344	8.55	8.75	14	B
D	0.386	0.394	9.80	10.00	16	C

NOTES:
 1. D&E DO NOT INCLUDE MOLD FLASH
 2. MOLD FLASH OR PROTRUSIONS NOT TO EXCEED .15mm (.006")
 3. LEADS TO BE COPLANAR WITHIN .102mm (.004")
 4. CONTROLLING DIMENSION: MILLIMETER
 5. MEETS JEDEC MS012-XX AS SHOWN IN ABOVE TABLE
 6. N = NUMBER OF PINS

MAXIM 120 SAN GABRIEL DR. SUNNYVALE, CA 94086 FAX: (408) 737-7378 PROPRIETARY INFORMATION TITLE

PACKAGE FAMILY OUTLINE: SOIC .150" 1/1

21-0041 A DOCUMENT CONTROL NUMBER REV

Maxim cannot assume responsibility for use of any circuitry other than circuitry entirely embodied in a Maxim product. No circuit patent licenses are implied. Maxim reserves the right to change the circuitry and specifications without notice at any time.

8 Maxim Integrated Products, 120 San Gabriel Drive, Sunnyvale, CA 94086 408-737-7600