

**50A, 60V, 0.022 Ohm, N-Channel Power MOSFETs**

These N-Channel power MOSFETs are manufactured using the MegaFET process. This process, which uses feature sizes approaching those of LSI integrated circuits gives optimum utilization of silicon, resulting in outstanding performance. They were designed for use in applications such as switching regulators, switching converters, motor drivers, and relay drivers. These transistors can be operated directly from integrated circuits.

Formerly developmental type TA49018.

**Ordering Information**

PART NUMBER	PACKAGE	BRAND
RFG50N06	TO-247	RFG50N06
RFP50N06	TO-220AB	RFP50N06
RF1S50N06SM	TO-263AB	F1S50N06

NOTE: When ordering, use the entire part number. Add the suffix, 9A, to obtain the TO-263AB variant in tape and reel, i.e. RF1S50N06SM9A.

**Features**

- 50A, 60V
- $r_{DS(ON)} = 0.022\Omega$
- Temperature Compensating PSPICE® Model
- Peak Current vs Pulse Width Curve
- UIS Rating Curve
- 175°C Operating Temperature

**Symbol**

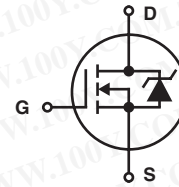

**Packaging**

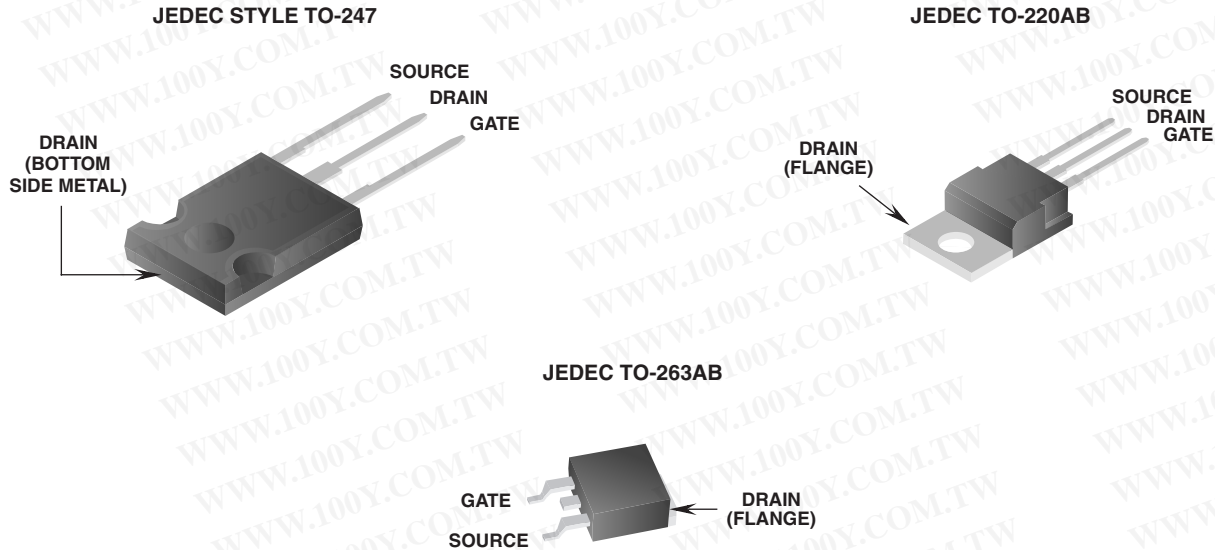

勝特力材料 886-3-5753170  
 勝特力电子(上海) 86-21-54151736  
 勝特力电子(深圳) 86-755-83298787  
[Http://www.100y.com.tw](http://www.100y.com.tw)

# RFG50N06, RFP50N06, RF1S50N06SM

## Absolute Maximum Ratings $T_C = 25^\circ\text{C}$ , Unless Otherwise Specified

	RFG50N06, RFP50N06 RF1S50N06SM	UNITS
Drain to Source Voltage (Note 1) . . . . .	$V_{DS}$ 60	V
Drain to Gate Voltage ( $R_{GS} = 20k\Omega$ ) (Note 1) . . . . .	$V_{DGR}$ 60	V
Gate to Source Voltage . . . . .	$V_{GS}$ $\pm 20$	V
Continuous Drain Current (Figure 2) . . . . .	$I_D$ 50	A
Pulsed Drain Current . . . . .	$I_{DM}$ (Figure 5)	
Pulsed Avalanche Rating . . . . .	$E_{AS}$ (Figure 6)	
Power Dissipation . . . . .	$P_D$ 131	W
Linear Derating Factor . . . . .	0.877	W/ $^\circ\text{C}$
Operating and Storage Temperature . . . . .	$T_J, T_{STG}$ -55 to 175	$^\circ\text{C}$
Maximum Temperature for Soldering		
Leads at 0.063in (1.6mm) from Case for 10s. . . . .	$T_L$ 300	$^\circ\text{C}$
Package Body for 10s, see Techbrief 334 . . . . .	$T_{pkg}$ 260	$^\circ\text{C}$

CAUTION: Stresses above those listed in "Absolute Maximum Ratings" may cause permanent damage to the device. This is a stress only rating and operation of the device at these or any other conditions above those indicated in the operational sections of this specification is not implied.

NOTE:

- $T_J = 25^\circ\text{C}$  to  $150^\circ\text{C}$ .

## Electrical Specifications $T_C = 25^\circ\text{C}$ , Unless Otherwise Specified

PARAMETER	SYMBOL	TEST CONDITIONS	MIN	TYP	MAX	UNITS	
Drain to Source Breakdown Voltage	$BV_{DS}$	$I_D = 250\mu\text{A}, V_{GS} = 0\text{V}$ (Figure 11)	60	-	-	V	
Gate to Source Threshold Voltage	$V_{GS(TH)}$	$V_{GS} = V_{DS}, I_D = 250\mu\text{A}$ (Figure 10)	2	-	4	V	
Zero Gate Voltage Drain Current	$I_{DSS}$	$V_{DS} = 60\text{V}, V_{GS} = 0\text{V}$	$T_C = 25^\circ\text{C}$	-	-	1	$\mu\text{A}$
			$T_C = 150^\circ\text{C}$	-	-	50	$\mu\text{A}$
Gate to Source Leakage Current	$I_{GSS}$	$V_{GS} = \pm 20\text{V}$	-	-	$\pm 100$	nA	
Drain to Source On Resistance	$r_{DS(ON)}$	$I_D = 50\text{A}, V_{GS} = 10\text{V}$ (Figures 9)	-	-	0.022	$\Omega$	
Turn-On Time	$t_{ON}$	$V_{DD} = 30\text{V}, I_D = 50\text{A}$ $R_L = 0.6\Omega, V_{GS} = 10\text{V}$ $R_{GS} = 3.6\Omega$ (Figure 13)	-	-	95	ns	
Turn-On Delay Time	$t_{d(ON)}$		-	12	-	ns	
Rise Time	$t_r$		-	55	-	ns	
Turn-Off Delay Time	$t_{d(OFF)}$		-	37	-	ns	
Fall Time	$t_f$		-	13	-	ns	
Turn-Off Time	$t_{OFF}$		-	-	75	ns	
Total Gate Charge	$Q_g(TOT)$	$V_{GS} = 0$ to $20\text{V}$	$V_{DD} = 48\text{V}, I_D = 50\text{A}, R_L = 0.96\Omega$ $I_{g(REF)} = 1.45\text{mA}$ (Figure 13)	-	125	150	nC
Gate Charge at 10V	$Q_g(10)$	$V_{GS} = 0$ to $10\text{V}$		-	67	80	nC
Threshold Gate Charge	$Q_g(TH)$	$V_{GS} = 0$ to $2\text{V}$		-	3.7	4.5	nC
Input Capacitance	$C_{ISS}$	$V_{DS} = 25\text{V}, V_{GS} = 0\text{V}$	-	2020	-	pF	
Output Capacitance	$C_{OSS}$	$f = 1\text{MHz}$ (Figure 12)	-	600	-	pF	
Reverse Transfer Capacitance	$C_{RSS}$		-	200	-	pF	
Thermal Resistance Junction to Case	$R_{\theta JC}$	(Figure 3)	-	-	1.14	$^\circ\text{C/W}$	
Thermal Resistance Junction to Ambient	$R_{\theta JA}$	TO-247	-	-	30	$^\circ\text{C/W}$	
		TO-220, TO-263	-	-	62	$^\circ\text{C/W}$	

## Source to Drain Diode Specifications

PARAMETER	SYMBOL	TEST CONDITIONS	MIN	TYP	MAX	UNITS
Source to Drain Diode Voltage	$V_{SD}$	$I_{SD} = 50\text{A}$	-	-	1.5	V
Reverse Recovery Time	$t_{rr}$	$I_{SD} = 50\text{A}, di_{SD}/dt = 100\text{A}/\mu\text{s}$	-	-	125	ns

Typical Performance Curves Unless Otherwise Specified

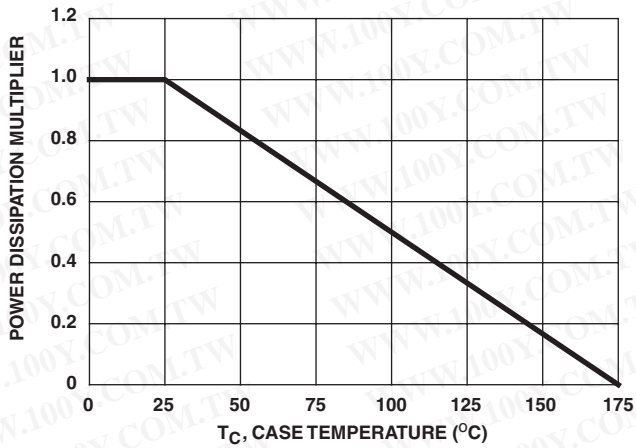

FIGURE 1. NORMALIZED POWER DISSIPATION vs CASE TEMPERATURE

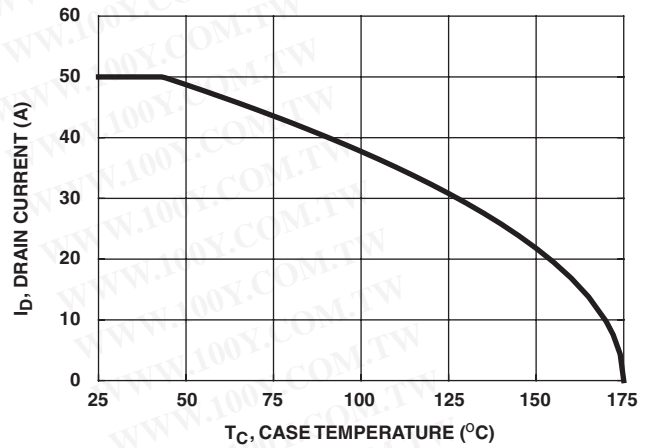

FIGURE 2. MAXIMUM CONTINUOUS DRAIN CURRENT vs CASE TEMPERATURE

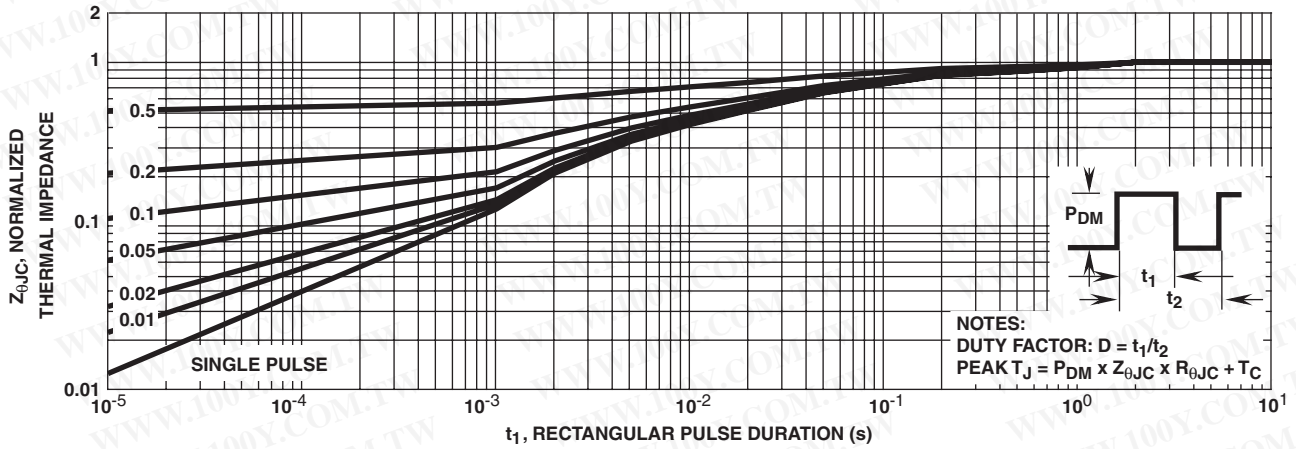

FIGURE 3. NORMALIZED MAXIMUM TRANSIENT THERMAL IMPEDANCE

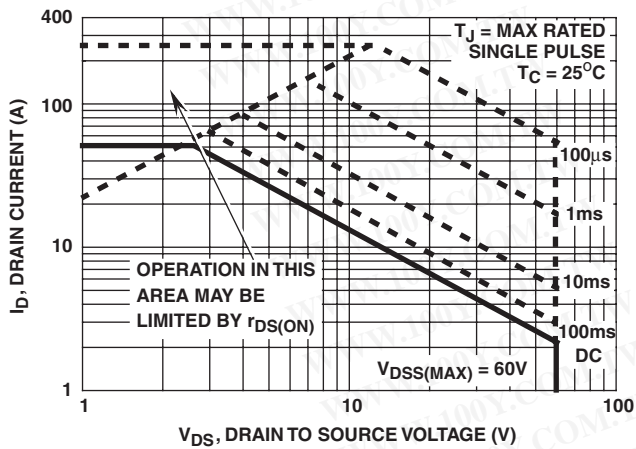

FIGURE 4. FORWARD BIAS SAFE OPERATING AREA

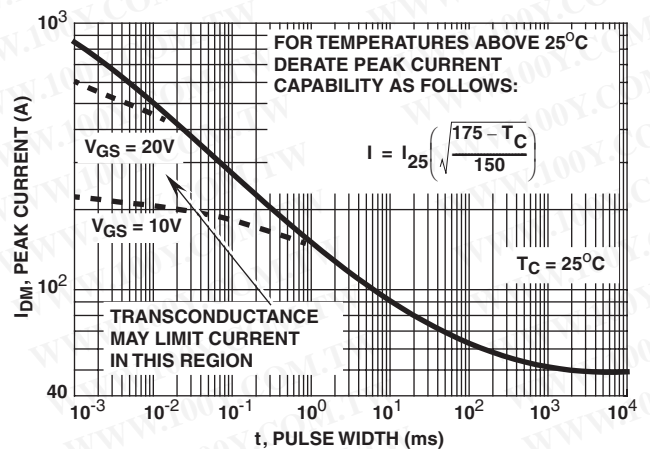
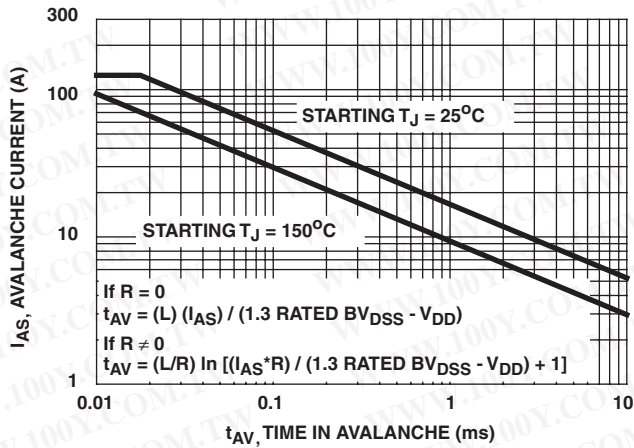

FIGURE 5. PEAK CURRENT CAPABILITY

Typical Performance Curves Unless Otherwise Specified (Continued)



NOTE: Refer to Fairchild Application Notes 9321 and 9322.

FIGURE 6. UNCLAMPED INDUCTIVE SWITCHING CAPABILITY

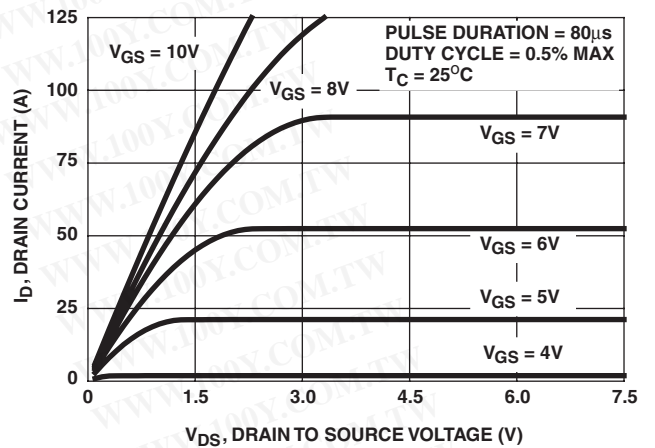

FIGURE 7. SATURATION CHARACTERISTICS

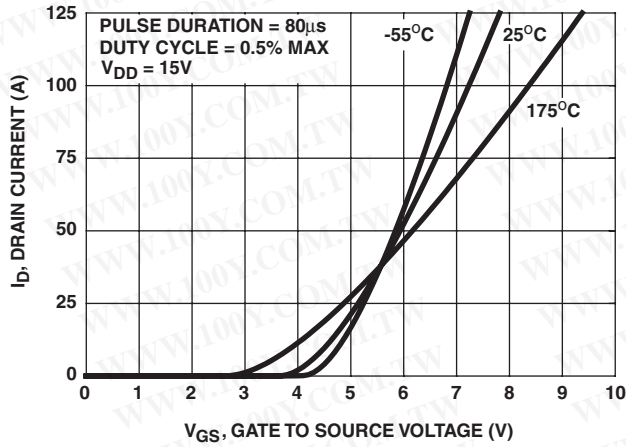

FIGURE 8. TRANSFER CHARACTERISTICS

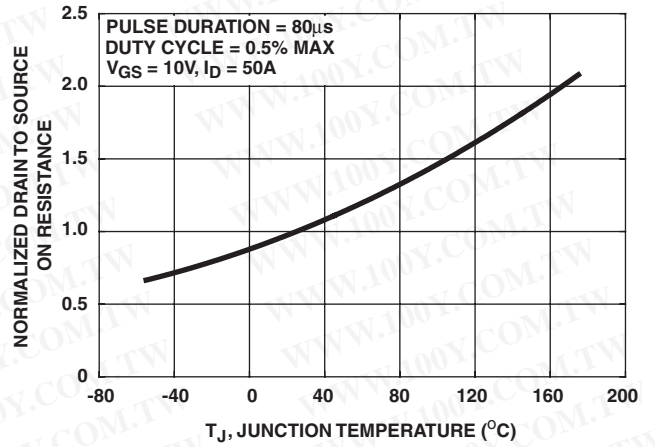

FIGURE 9. NORMALIZED DRAIN TO SOURCE ON RESISTANCE vs JUNCTION TEMPERATURE

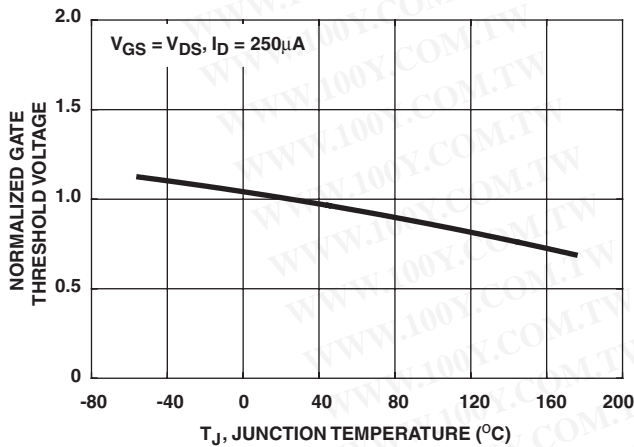

FIGURE 10. NORMALIZED GATE THRESHOLD VOLTAGE vs JUNCTION TEMPERATURE

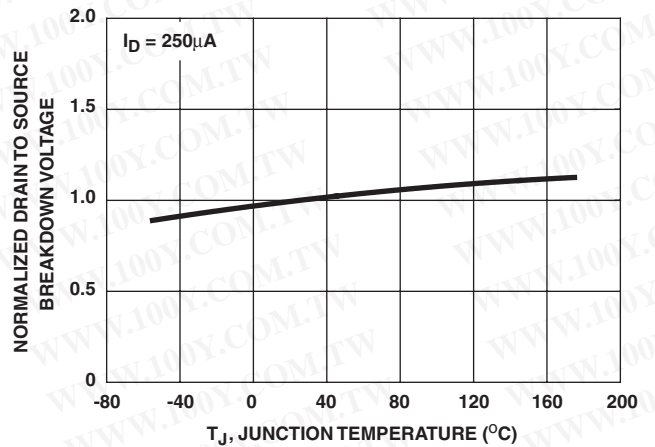

FIGURE 11. NORMALIZED DRAIN TO SOURCE BREAKDOWN VOLTAGE vs JUNCTION TEMPERATURE

**勝特力材料 886-3-5753170**  
**勝特力电子(上海) 86-21-54151736**  
**勝特力电子(深圳) 86-755-83298787**  
[Http://www.100y.com.tw](http://www.100y.com.tw)

Typical Performance Curves Unless Otherwise Specified (Continued)

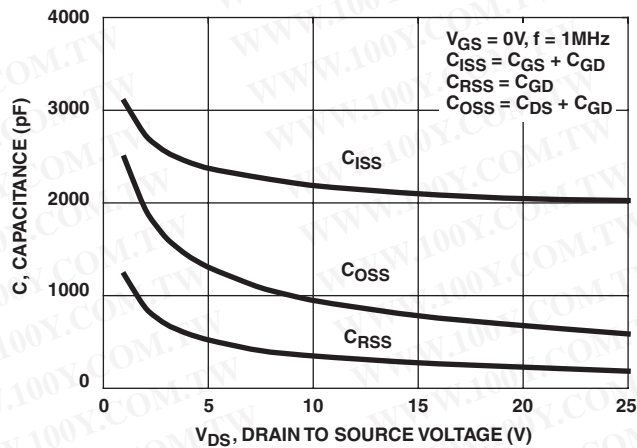
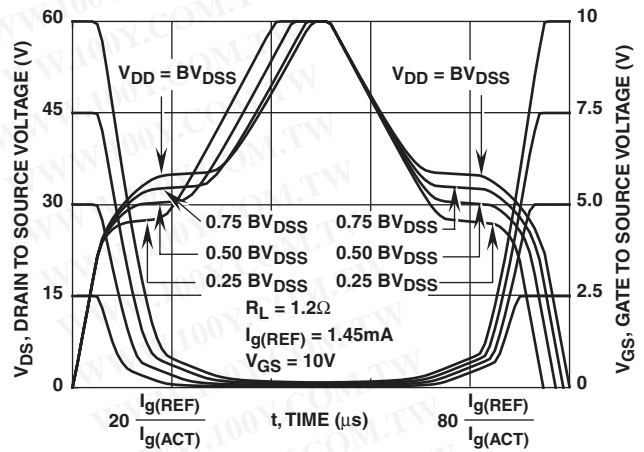

FIGURE 12. CAPACITANCE vs DRAIN TO SOURCE VOLTAGE



NOTE: Refer to Fairchild Application Notes AN7254 and AN7260.

FIGURE 13. NORMALIZED SWITCHING WAVEFORMS FOR CONSTANT GATE CURRENT

Test Circuits and Waveforms

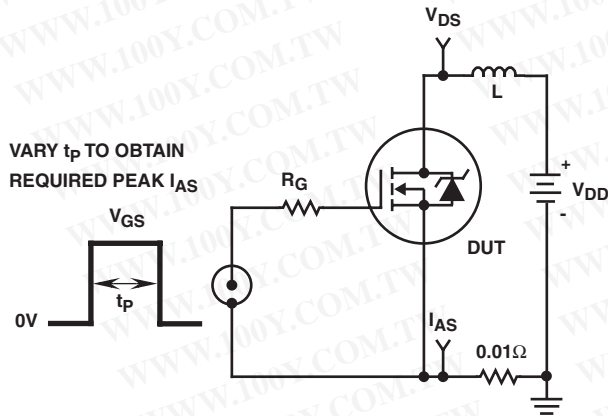

FIGURE 14. UNCLAMPED ENERGY TEST CIRCUIT

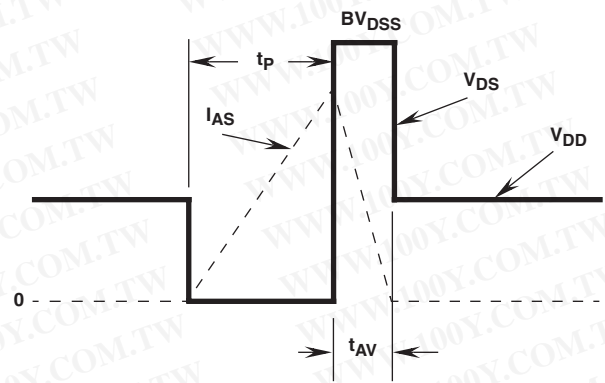

FIGURE 15. UNCLAMPED ENERGY WAVEFORMS

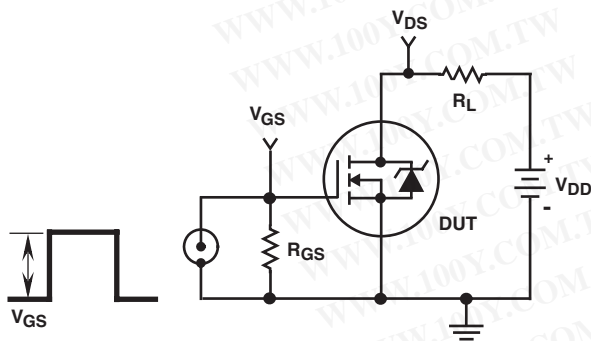

FIGURE 16. SWITCHING TIME TEST CIRCUIT

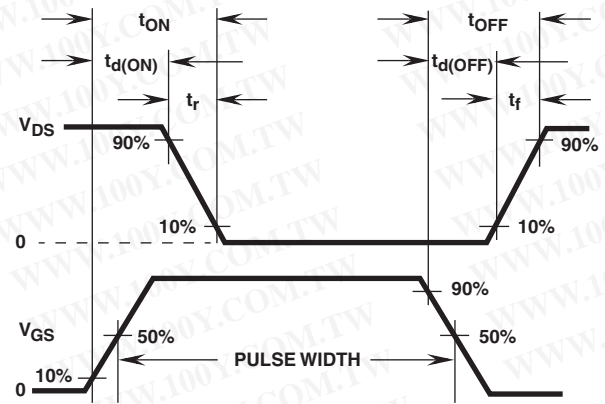

FIGURE 17. SWITCHING WAVEFORMS

Test Circuits and Waveforms (Continued)

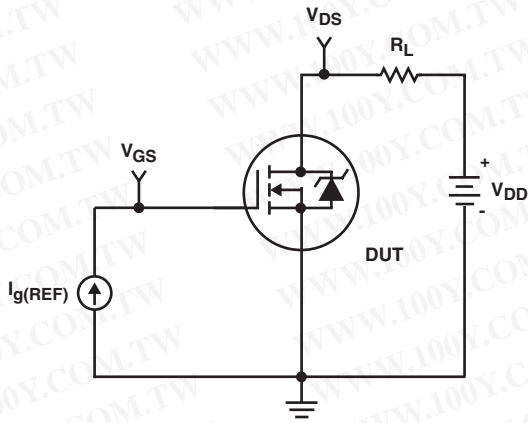

FIGURE 18. GATE CHARGE TEST CIRCUIT

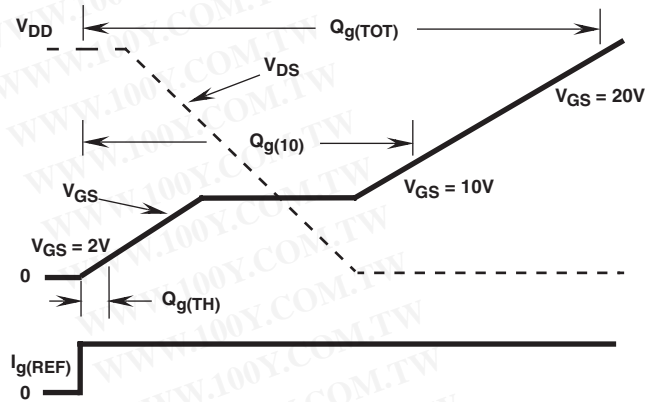

FIGURE 19. GATE CHARGE WAVEFORMS

勝特力材料 886-3-5753170  
 勝特力电子(上海) 86-21-54151736  
 勝特力电子(深圳) 86-755-83298787  
[Http://www.100y.com.tw](http://www.100y.com.tw)

# RFG50N06, RFP50N06, RF1S50N06SM

## PSPICE Electrical Model

.SUBCKT RFP50N06 2 1 3

REV 2/22/93

\*NOM TEMP = 25°C

CA 12 8 3.68e-9  
 CB 15 14 3.625e-9  
 CIN 6 8 1.98e-9

DBODY 7 5 DBDMOD  
 DBREAK 5 11 DBKMOD  
 DPLCAP 10 5 DPLCAPMOD

EBREAK 11 7 17 18 64.59  
 EDS 14 8 5 8 1  
 EGS 13 8 6 8 1  
 ESG 6 10 6 8 1  
 EVTO 20 6 18 8 1

IT 8 17 1

LDRAIN 2 5 1e-9  
 LGATE 1 9 5.65e-9  
 LSOURCE 3 7 4.13e-9

MOS1 16 6 8 8 MOSMOD M=0.99  
 MOS2 16 21 8 8 MOSMOD M=0.01

RBREAK 17 18 RBKMOD 1  
 RDRAIN 5 16 RDSMOD 1e-4  
 RGATE 9 20 0.690  
 RIN 6 8 1e9  
 RSOURCE 8 7 RDSMOD 12e-3  
 RVTO 18 19 RVTOMOD 1

S1A 6 12 13 8 S1AMOD  
 S1B 13 12 13 8 S1BMOD  
 S2A 6 15 14 13 S2AMOD  
 S2B 13 15 14 13 S2BMOD

VBAT 8 19 DC 1  
 VTO 21 6 0.678

.MODEL DBDMOD D (IS=9.85e-13 RS=4.91e-3 TRS1=2.07e-3 TRS2=2.51e-7 CJO=2.05e-9 TT=4.33e-8)  
 .MODEL DBKMOD D (RS=1.98e-1 TRS1=2.35E-4 TRS2=-3.83e-6)  
 .MODEL DPLCAPMOD D (CJO=1.42e-9 IS=1e-30 N=10)  
 .MODEL MOSMOD NMOS (VTO=3.65 KP=35 IS=1e-30 N=10 TOX=1 L=1u W=1u)  
 .MODEL RBKMOD RES (TC1=1.23e-3 TC2=-2.34e-7)  
 .MODEL RDSMOD RES (TC1=5.01e-3 TC2=1.49e-5)  
 .MODEL RVTOMOD RES (TC1=-5.03e-3 TC2=-5.16e-6)  
 .MODEL S1AMOD VSWITCH (RON=1e-5 ROFF=0.1 VON=-6.75 VOFF=-2.5)  
 .MODEL S1BMOD VSWITCH (RON=1e-5 ROFF=0.1 VON=-2.5 VOFF=-6.75)  
 .MODEL S2AMOD VSWITCH (RON=1e-5 ROFF=0.1 VON=-2.7 VOFF=2.3)  
 .MODEL S2BMOD VSWITCH (RON=1e-5 ROFF=0.1 VON=2.3 VOFF=-2.7)

.ENDS

NOTE: For further discussion of the PSPICE model consult **A New PSPICE Sub-Circuit for the Power MOSFET Featuring Global Temperature Options**; authors, William J. Hepp and C. Frank Wheatley.

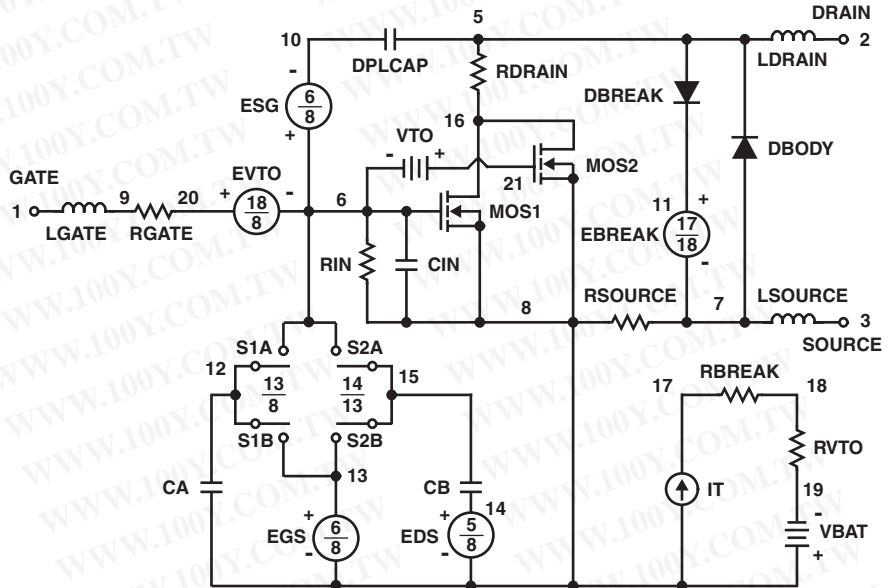

勝特力材料 886-3-5753170  
 勝特力电子(上海) 86-21-54151736  
 勝特力电子(深圳) 86-755-83298787  
[Http://www.100y.com.tw](http://www.100y.com.tw)

## TRADEMARKS

The following are registered and unregistered trademarks Fairchild Semiconductor owns or is authorized to use and is not intended to be an exhaustive list of all such trademarks.

ACE <sub>x</sub> <sup>TM</sup>	FAST <sup>®</sup>	OPTOLOGIC <sup>TM</sup>	SMART START <sup>TM</sup>	VCX <sup>TM</sup>
Bottomless <sup>TM</sup>	FAST <sub>r</sub> <sup>TM</sup>	OPTOPLANAR <sup>TM</sup>	STAR*POWER <sup>TM</sup>	
CoolFET <sup>TM</sup>	FRFET <sup>TM</sup>	PACMAN <sup>TM</sup>	Stealth <sup>TM</sup>	
CROSSVOLT <sup>TM</sup>	GlobalOptoisolator <sup>TM</sup>	POPT <sup>TM</sup>	SuperSOT <sup>TM</sup> -3	
DenseTrench <sup>TM</sup>	GTO <sup>TM</sup>	Power247 <sup>TM</sup>	SuperSOT <sup>TM</sup> -6	
DOMET <sup>TM</sup>	HiSeC <sup>TM</sup>	PowerTrench <sup>®</sup>	SuperSOT <sup>TM</sup> -8	
EcoSPARK <sup>TM</sup>	ISOPLANAR <sup>TM</sup>	QFET <sup>TM</sup>	SyncFET <sup>TM</sup>	
E <sup>2</sup> CMOS <sup>TM</sup>	LittleFET <sup>TM</sup>	QS <sup>TM</sup>	TinyLogic <sup>TM</sup>	
EnSigna <sup>TM</sup>	MicroFET <sup>TM</sup>	QT Optoelectronics <sup>TM</sup>	TruTranslation <sup>TM</sup>	
FACT <sup>TM</sup>	MicroPak <sup>TM</sup>	Quiet Series <sup>TM</sup>	UHC <sup>TM</sup>	
FACT Quiet Series <sup>TM</sup>	MICROWIRE <sup>TM</sup>	SILENT SWITCHER <sup>®</sup>	UltraFET <sup>®</sup>	

STAR\*POWER is used under license

## DISCLAIMER

FAIRCHILD SEMICONDUCTOR RESERVES THE RIGHT TO MAKE CHANGES WITHOUT FURTHER NOTICE TO ANY PRODUCTS HEREIN TO IMPROVE RELIABILITY, FUNCTION OR DESIGN. FAIRCHILD DOES NOT ASSUME ANY LIABILITY ARISING OUT OF THE APPLICATION OR USE OF ANY PRODUCT OR CIRCUIT DESCRIBED HEREIN; NEITHER DOES IT CONVEY ANY LICENSE UNDER ITS PATENT RIGHTS, NOR THE RIGHTS OF OTHERS.

## LIFE SUPPORT POLICY

FAIRCHILD'S PRODUCTS ARE NOT AUTHORIZED FOR USE AS CRITICAL COMPONENTS IN LIFE SUPPORT DEVICES OR SYSTEMS WITHOUT THE EXPRESS WRITTEN APPROVAL OF FAIRCHILD SEMICONDUCTOR CORPORATION.

As used herein:

1. Life support devices or systems are devices or systems which, (a) are intended for surgical implant into the body, or (b) support or sustain life, or (c) whose failure to perform when properly used in accordance with instructions for use provided in the labeling, can be reasonably expected to result in significant injury to the user.
2. A critical component is any component of a life support device or system whose failure to perform can be reasonably expected to cause the failure of the life support device or system, or to affect its safety or effectiveness.

## PRODUCT STATUS DEFINITIONS

### Definition of Terms

Datasheet Identification	Product Status	Definition
Advance Information	Formative or In Design	This datasheet contains the design specifications for product development. Specifications may change in any manner without notice.
Preliminary	First Production	This datasheet contains preliminary data, and supplementary data will be published at a later date. Fairchild Semiconductor reserves the right to make changes at any time without notice in order to improve design.
No Identification Needed	Full Production	This datasheet contains final specifications. Fairchild Semiconductor reserves the right to make changes at any time without notice in order to improve design.
Obsolete	Not In Production	This datasheet contains specifications on a product that has been discontinued by Fairchild semiconductor. The datasheet is printed for reference information only.

勝特力材料 886-3-5753170  
勝特力电子(上海) 86-21-54151736  
勝特力电子(深圳) 86-755-83298787  
[Http://www.100y.com.tw](http://www.100y.com.tw)

Rev. H4