

### Features

- Industry standard driver replacement
- Improved response times
- Matched rise and fall times
- Reduced clock skew
- Low output impedance
- Low input capacitance
- High noise immunity
- Improved clocking rate
- Low supply current
- Wide operating voltage range

### Applications

- Clock/line drivers
- CCD Drivers
- Ultra-sound transducer drivers
- Power MOSFET drivers
- Switch mode power supplies
- Class D switching amplifiers
- Ultrasonic and RF generators
- Pulsed circuits

### Ordering Information

Part No.	Temp. Range	Pkg.	Outline #
EL7202CN	-40°C to +85°C	8-Pin P-DIP	MDP0031
EL7202CS	-40°C to +85°C	8-Pin SO	MDP0027
EL7212CN	-40°C to +85°C	8-Pin P-DIP	MDP0031
EL7212CS	-40°C to +85°C	8-Pin SO	MDP0027
EL7222CN	-40°C to +85°C	8-Pin P-DIP	MDP0031
EL7222CS	-40°C to +85°C	8-Pin SO	MDP0027

### General Description

The EL7202C/EL7212C/EL7222C ICs are matched dual-drivers ICs that improve the operation of the industry standard DS0026 clock drivers. The Elantec Versions are very high speed drivers capable of delivering peak currents of 2.0 amps into highly capacitive loads. The high speed performance is achieved by means of a proprietary "Turbo-Driver" circuit that speeds up input stages by tapping the wider voltage swing at the output. Improved speed and drive capability are enhanced by matched rise and fall delay times. These matched delays maintain the integrity of input-to-output pulse-widths to reduce timing errors and clock skew problems. This improved performance is accompanied by a 10 fold reduction in supply currents over bipolar drivers, yet without the delay time problems commonly associated with CMOS devices. Dynamic switching losses are minimized with non-overlapped drive techniques.

### Connection Diagrams

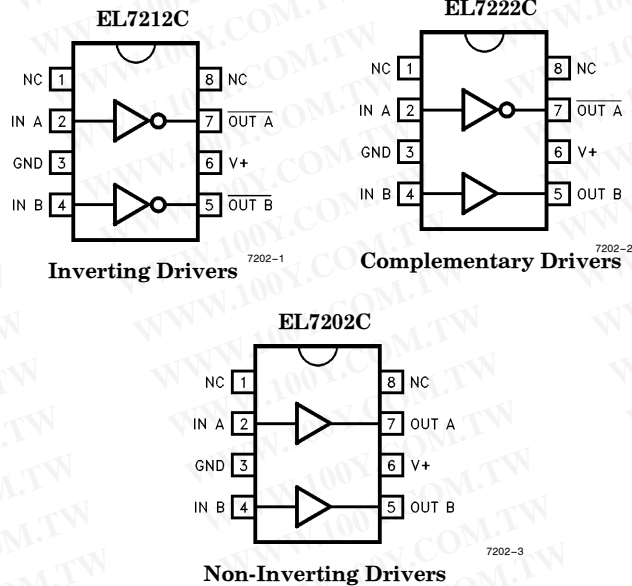

Manufactured under U.S. Patent Nos. 5,334,883, #5,341,047

Note: All information contained in this data sheet has been carefully checked and is believed to be accurate as of the date of publication; however, this data sheet cannot be a "controlled document". Current revisions, if any, to these specifications are maintained at the factory and are available upon your request. We recommend checking the revision level before finalization of your design documentation.

# EL7202C/EL7212C/EL7222C

## High Speed, Dual Channel Power MOSFET Drivers

### Absolute Maximum Ratings

Supply (V+ to Gnd)	16.5V	Operating Junction Temperature	125°C
Input Pins	-0.3V to +0.3V above V+	Power Dissipation	
Combined Peak Output Current	4A	SOIC	570 mW
Storage Temperature Range	-65°C to +150°C	PDIP	1050 mW
Ambient Operating Temperature	-40°C to +85°C		

#### Important Note:

All parameters having Min/Max specifications are guaranteed. The Test Level column indicates the specific device testing actually performed during production and Quality inspection. Elantec performs most electrical tests using modern high-speed automatic test equipment, specifically the LTX77 Series system. Unless otherwise noted, all tests are pulsed tests, therefore  $T_J = T_C = T_A$ .

Test Level	Test Procedure
I	100% production tested and QA sample tested per QA test plan QCX0002.
II	100% production tested at $T_A = 25^\circ\text{C}$ and QA sample tested at $T_A = 25^\circ\text{C}$ , $T_{MAX}$ and $T_{MIN}$ per QA test plan QCX0002.
III	QA sample tested per QA test plan QCX0002.
IV	Parameter is guaranteed (but not tested) by Design and Characterization Data.
V	Parameter is typical value at $T_A = 25^\circ\text{C}$ for information purposes only.

### DC Electrical Characteristics $T_A = 25^\circ\text{C}$ , $V = 15\text{V}$ unless otherwise specified

Parameter	Description	Test Conditions	Min	Typ	Max	Test Level	Units
<b>Input</b>							
$V_{IH}$	Logic "1" Input Voltage		2.4			I	V
$I_{IH}$	Logic "1" Input Current	@V+		0.1	10	I	$\mu\text{A}$
$V_{IL}$	Logic "0" Input Voltage				0.8	I	V
$I_{IL}$	Logic "0" Input Current	@0V		0.1	10	I	$\mu\text{A}$
$V_{HVS}$	Input Hysteresis			0.3		V	V
<b>Output</b>							
$R_{OH}$	Pull-Up Resistance	$I_{OUT} = -100\text{ mA}$		3	6	I	$\Omega$
$R_{OL}$	Pull-Down Resistance	$I_{OUT} = +100\text{ mA}$		4	6	I	$\Omega$
$I_{PK}$	Peak Output Current	Source Sink		2 2		IV	A
$I_{DC}$	Continuous Output Current	Source/Sink	100			I	mA
<b>Power Supply</b>							
$I_S$	Power Supply Current	Inputs High/7202 Inputs High/7212 Inputs High/7222		4.5 1 2.5	7.5 2.5 5.0	I I I	mA
$V_S$	Operating Voltage		4.5		15	I	V

# EL7202C/EL7212C/EL7222C

## High Speed, Dual Channel Power MOSFET Drivers

**AC Electrical Characteristics**  $T_A = 25^\circ\text{C}$ ,  $V = 15\text{V}$  unless otherwise specified

Parameter	Description	Test Conditions	Min	Typ	Max	Test Level	Units
<b>Switching Characteristics</b>							
$t_R$	Rise Time	$C_L = 500\text{ pF}$ $C_L = 1000\text{ pF}$		7.5 10	20	IV	ns
$t_F$	Fall Time	$C_L = 500\text{ pF}$ $C_L = 1000\text{ pF}$		10 13	20	IV	ns
$t_{D1}$	Turn-On Delay Time	See Timing Table		18	25	IV	ns
$t_{D2}$	Turn-Off Delay Time	See Timing Table		20	25	IV	ns

**Timing Table**

7202-4

**Standard Test Configuration**

7202-19

**Simplified Schematic**

7202-5

# EL7202C/EL7212C/EL7222C

## High Speed, Dual Channel Power MOSFET Drivers

### Typical Performance Curve

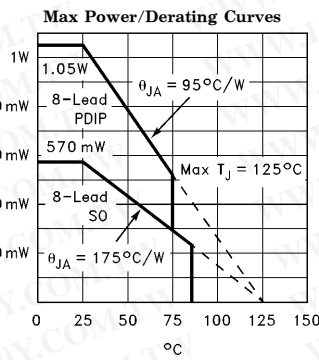

7202-6

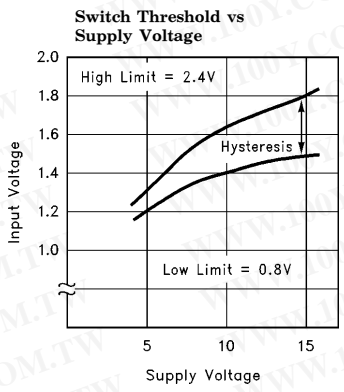

7202-7

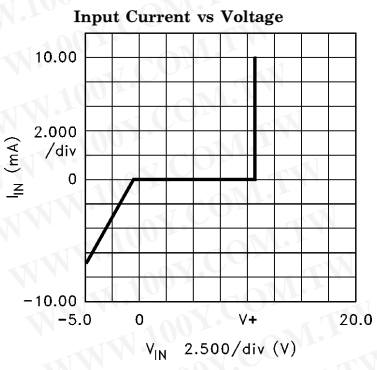

7202-8

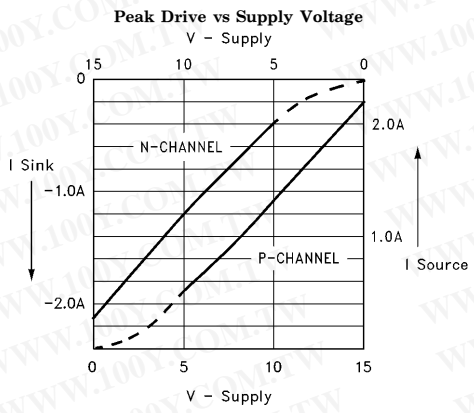

7202-9

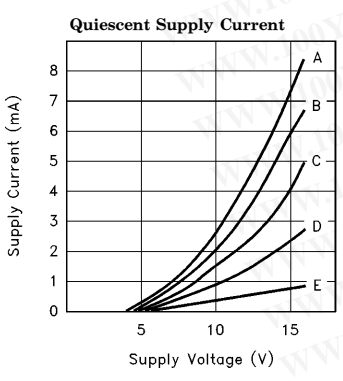

Device	Input Level	Curve
EL7202	GND	A
EL7202	GND, V+	B
EL7202	V+	C
EL7212	GND	C
EL7212	GND, V+	D
EL7212	V+	E
EL7222	GND	B
EL7222	GND, V+	C
EL7222	V+	D

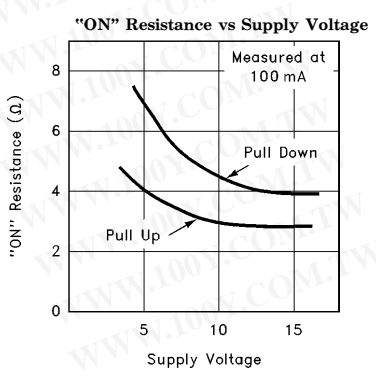

7202-10

7202-11

# EL7202C/EL7212C/EL7222C

## High Speed, Dual Channel Power MOSFET Drivers

### Typical Performance Curve — Contd.

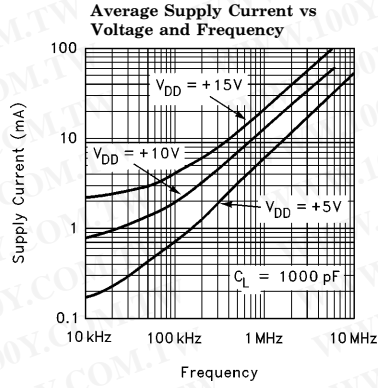

7202-12

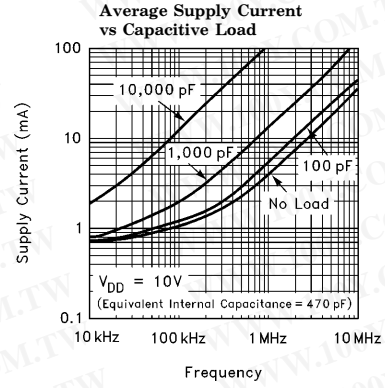

7202-13

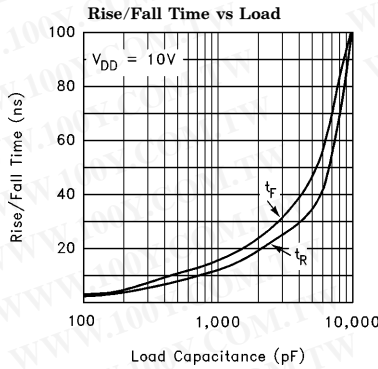

7202-14

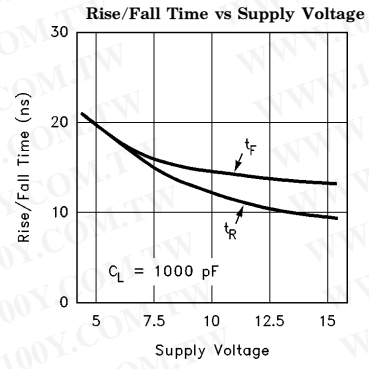

7202-15

# EL7202C/EL7212C/EL7222C

## High Speed, Dual Channel Power MOSFET Drivers

### Typical Performance Curve — Contd.

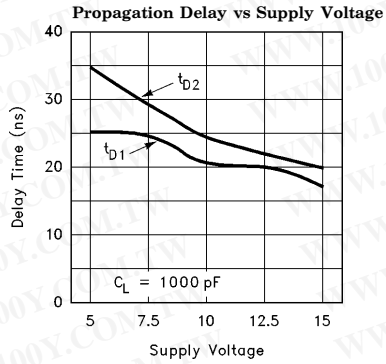

7202-16

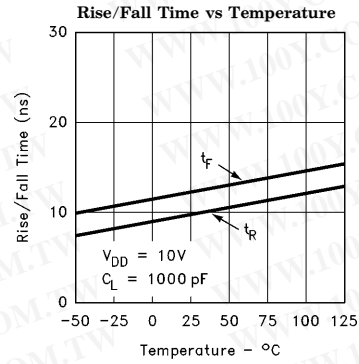

7202-17

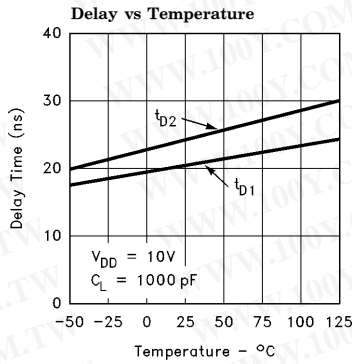

7202-18

