



Capacitive Proximity Sensor

E2K-X

Threaded Cylindrical Capacitive Proximity Sensor

- Detects almost any kind of metallic and nonmetallic objects, including glass, lumber, water, oil, and plastic.
- Three choices of threaded cylinder sizes for easy installation: M12, M18, and M30
- All models equipped with an LED indicator for operation monitoring.
- Fixed sensing distance requires no sensitivity adjustment.



Ordering Information

Shield	Size	Sensing distance	DC 3-wire models				AC 2-wire models	
			NPN		PNP		NO	NC
			NO	NC	NO	NC		
Unshielded	M12	4 mm	E2K-X4ME1	E2K-X4ME2	E2K-X4MF1	E2K-X4MF2	E2K-X4MY1	E2K-X4MY2
	M18	8 mm	E2K-X8ME1	E2K-X8ME2	E2K-X8MF1	E2K-X8MF2	E2K-X8MY1	E2K-X8MY2
	M30	15 mm	E2K-X15ME1	E2K-X15ME2	E2K-X15MF1	E2K-X15MF2	E2K-X15MY1	E2K-X15MY2

Specifications

Model	E2K-X4ME(F)□	E2K-X8ME(F)□	E2K-X15ME(F)□	E2K-X4MY□	E2K-X8MY□	E2K-X15MY□
Supply voltage (operating voltage range) (see note 1)	12 to 24 VDC (10 to 30 VDC)			100 to 220 VAC (90 to 250 VAC)		
Current consumption	15 mA			2.2 mA max. (Refer to <i>Engineering Data</i> .)		
Sensing object	Conductors and dielectrics					
Sensing distance	4 mm±10%	8 mm±10%	15 mm±10%	4 mm±10%	8 mm±10%	15 mm±10%
Sensitivity	Fixed					
Differential travel	4% to 20% of sensing distance					
Control output	200 mA			10 to 200 mA		
Response frequency	100 Hz			10 Hz		
Indicator	Operation indicator (red)					
Circuit protection	Reverse connection protection, surge absorber			Surge absorber		
Setting distance (for standard sensing object) (see note 2)	0 to 2.8 mm with grounded object (50 x 50 x 1 mm)	0 to 5.6 mm with grounded object (50 x 50 x 1 mm)	0 to 10 mm with grounded object (50 x 50 x 1 mm)	0 to 2.8 mm with grounded object (50 x 50 x 1 mm)	0 to 5.6 mm with grounded object (50 x 50 x 1 mm)	0 to 10 mm with grounded object (50 x 50 x 1 mm)
Operating status (with sensing object approaching)	E1 models: Load ON, L-level output signal E2 models: Load OFF, H-level output signal			Y1 models: Load ON		

Model	E2K-X4ME(F)□	E2K-X8ME(F)□	E2K-X15ME(F)□	E2K-X4MY□	E2K-X8MY□	E2K-X15MY□
Ambient temperature	-25°C to 70°C (with no icing)		-10°C to 55°C (with no icing)	-25°C to 70°C (with no icing)		-10°C to 55°C (with no icing)
Ambient humidity	Operating: 35% to 95%					
Temperature influence	±20% max. of sensing distance at 23°C in the temperature range of -25°C to 70°C		±20% max. of sensing distance at 23°C in the temperature range of -10°C to 55°C	±20% max. of sensing distance at 23°C in the temperature range of -25°C to 70°C		±20% max. of sensing distance at 23°C in the temperature range of -10°C to 55°C
Voltage influence	E models: ±2% max. of sensing distance at a voltage between 80% and 120% of the rated power supply voltage			Y models: ±2% max. of sensing distance at a voltage between 90% and 110% of the rated power supply voltage		
Residual voltage	E models: 1.0 V max. under a load current of 200 mA and a cord length of 2 m			Y models: Refer to <i>Residual Load Voltage (Typical)</i> in the following <i>Engineering Data</i> .		
Insulation resistance	50 MΩ (at 500 VDC) between the case and current carry parts					
Dielectric strength	DC models: 1,000 VAC (50/60 Hz) for 1 min between the case and current carry parts AC models: 2,000 V (50/60 Hz) for 1 min between the case and current carry parts					
Vibration resistance	Malfunction: 10 to 55 Hz, 1.5-mm double amplitude for 2 hours each in X, Y, and Z directions					
Shock resistance	Malfunction: 500 m/s ² (approx. 50G) 3 times each in X, Y, and Z directions.					
Enclosure rating	IEC IP66					
Weight (with 2-m cord)	Approx. 65 g	Approx. 145 g	Approx. 205 g	Approx. 65 g	Approx. 145 g	Approx. 205 g
Material	Case	Heat-resistant ABS resin				
	Sensing surface	Heat-resistant ABS resin				
Clamping nut	Polyacetal resin					

- Note:**
- DC models (i.e., Sensors with model numbers including the suffix "E") operate with full-wave rectified power supplies at 24 VDC±20% (mean value).
 - The set distances are sensing distances applicable to standard sensing objects. Refer to *Engineering Data* for sensing distances applicable to other types of objects.

Engineering Data

Operating Range (Typical)

E2K-X4M□□, E2K-X8M□□, E2K-X15M□□

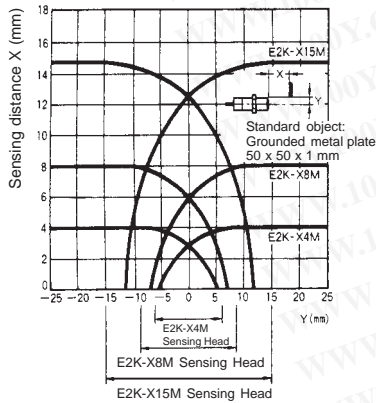

Leakage Current (Typical)

E2K-X□MY

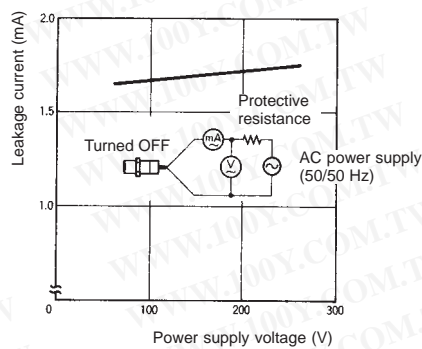

勝特力材料 886-3-5753170
 勝特力电子(上海) 86-21-54151736
 勝特力电子(深圳) 86-755-83298787
[Http://www.100y.com.tw](http://www.100y.com.tw)

Sensing Object Size and Material vs. Sensing Distance (Typical)

E2K-X4M

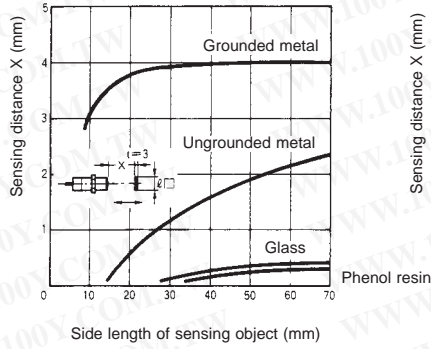

E2K-X8M

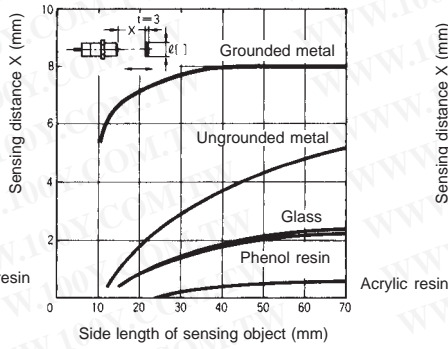

E2K-X15M

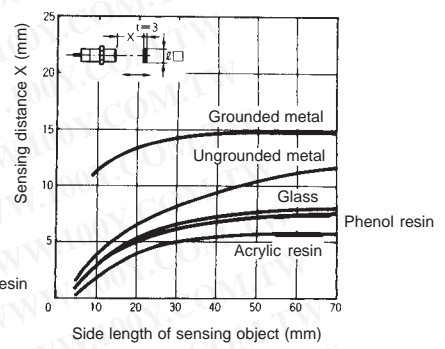

Sensing Object Thickness and Material vs. Sensing Distance (Typical)

E2K-X4M

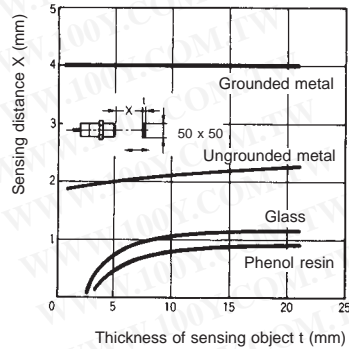

E2K-X8M

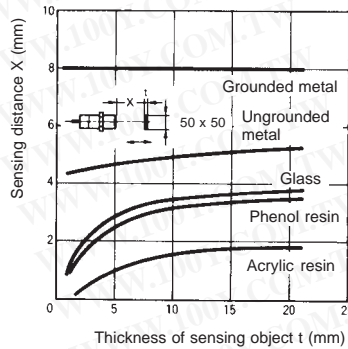

E2K-X15M

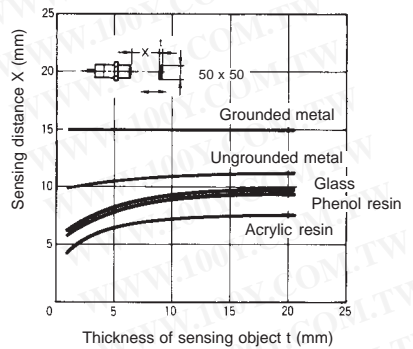

Operation

Output Circuits

Note: The lead wire colors of the E2K-X have been changed in compliance with the latest Japanese Industrial Standards. Colors in parentheses are previous ones.

DC 3-wire Models

NPN (E2K-X□ME□)

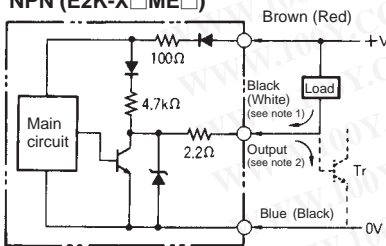

Note: 1. 200 mA max. (load current)
2. When a transistor is connected

PNP (E2K-X□MF□)

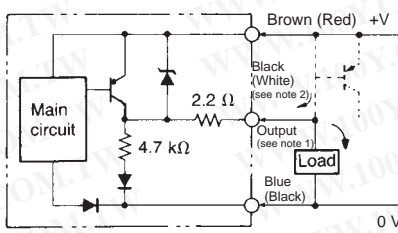

Note: 1. 200 mA max. (load current)
2. When a transistor is connected

AC 2-wire Models

NPN (E2K-X□MY□)

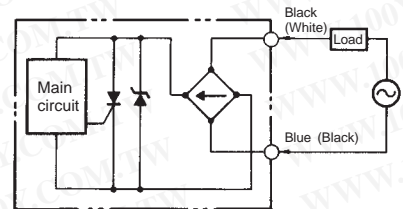

Timing Charts

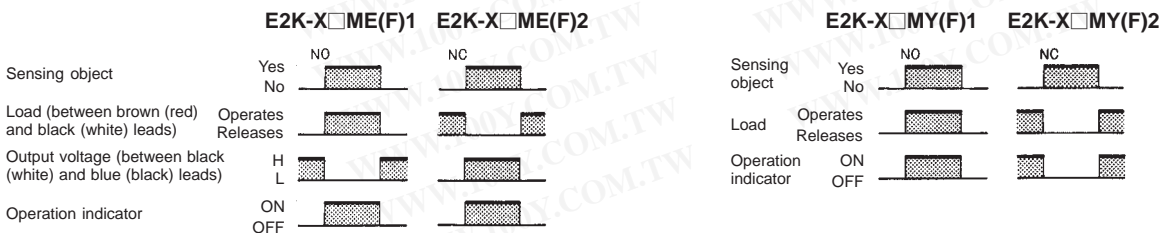

勝特力材料 886-3-5753170
 勝特力电子(上海) 86-21-54151736
 勝特力电子(深圳) 86-755-83298787
[Http://www.100y.com.tw](http://www.100y.com.tw)

Dimensions

E2K-X4M□□

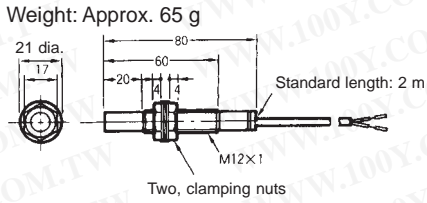

E2K-K-X4ME(F)1 and E2K-X4ME(F)2:

Oil- and vibration-resistant, vinyl-insulated round cord with three conductors, 4 dia. (0.2 mm² x 3); standard length: 2 m

E2K-K-X4MY1 and E2K-X4MY2:

Oil- and vibration-resistant, vinyl-insulated round cord with three conductors, 4 dia. (0.2 mm² x 2); standard length: 2 m

E2K-X8M□□

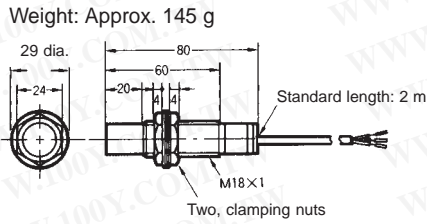

E2K-K-X8ME(F)1 and E2K-X8ME(F)2:

Oil- and vibration-resistant, vinyl-insulated round cord with three conductors, 6 dia. (0.2 mm² x 3); standard length: 2 m

E2K-K-X8MY1 and E2K-X8MY2:

Oil- and vibration-resistant, vinyl-insulated round cord with three conductors, 6 dia. (0.2 mm² x 2); standard length: 2 m

E2K-X15M□□

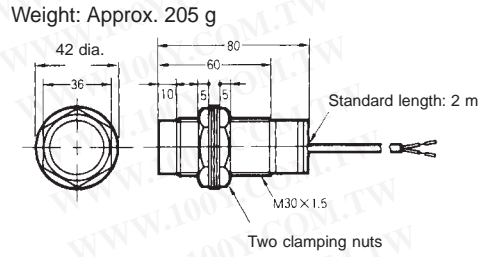

E2K-K-X15ME(F)1 and E2K-X15ME(F)2:

Oil- and vibration-resistant, vinyl-insulated round cord with three conductors, 6 dia. (0.2 mm² x 3); standard length: 2 m

E2K-K-X15MY1 and E2K-X15MY2:

Oil- and vibration-resistant, vinyl-insulated round cord with three conductors, 6 dia. (0.2 mm² x 3); standard length: 2 m

Mounting Holes

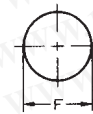

Model	F (mm)
E2K-X4ME(F)□ E2K-X4MY□	12.5 ^{+0.5} / ₀ dia.
E2K-X8ME(F)□ E2K-X8MY□	18.5 ^{+0.5} / ₀ dia.
E2K-X15ME(F)□ E2K-X15MY□	30.5 ^{+0.5} / ₀ dia.

Accessories (Order Separately)

Y92E-B□

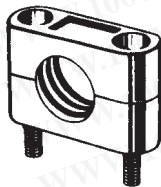

Plastic mounting fixtures are available as options. Select the one suitable for the dimensions of the Sensor.

Precautions

Effects of Surrounding Metals and Mutual Influence

When mounting a Proximity Sensor flush with a metallic panel, or when installing two or more identical Sensors face-to-face or side-by-side, be sure to provide a minimum distance as shown in the following table. Using the minimum distances in the table will prevent the Sensor from being affected by metallic objects other than the sensing object or will prevent mutual interference between the two Sensors.

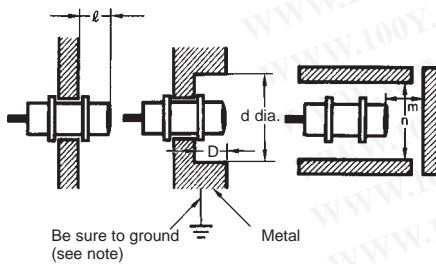

Note: Always ground the metallic panel or object; otherwise, the Sensor may malfunction.

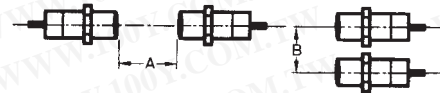

Distance	Model		
	E2K-X4M□□	E2K-X8M□□	E2K-X15M□□
ℓ	20	20	10
d	50	50	50
D	20	20	10
m	8	12	25
n	60	60	60
A	80	150	300
B	70	110	200

勝特力材料 886-3-5753170
 勝特力电子(上海) 86-21-54151736
 勝特力电子(深圳) 86-755-83298787
[Http://www.100y.com.tw](http://www.100y.com.tw)

Connection to the Load

Be sure to connect the Sensor to a power source through a load.
Direct connection of a power source may damage the Sensor

E2K-X4MY□, E2K-X8MY□, E2K-X15MY□

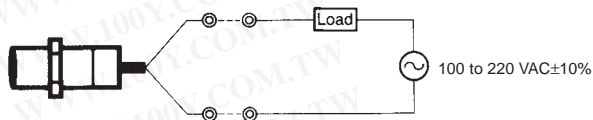

勝特力材料 886-3-5753170
勝特力电子(上海) 86-21-54151736
勝特力电子(深圳) 86-755-83298787
[Http://www.100y.com.tw](http://www.100y.com.tw)