

Manganese Dioxide Lithium Coin Batteries: Individual Specifications

CR2016

■ Dimensions(mm)

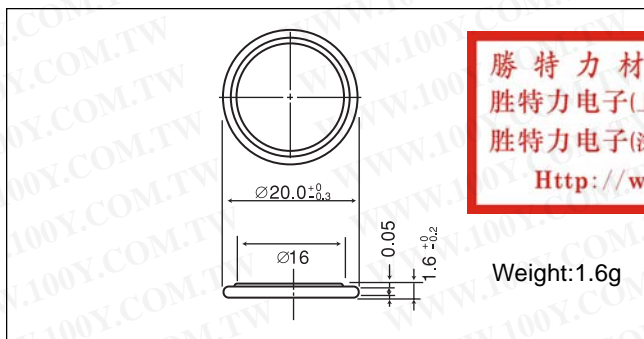

勝特力材料 886-3-5753170
 勝特力电子(上海) 86-21-54151736
 勝特力电子(深圳) 86-755-83298787
[Http://www.100y.com.tw](http://www.100y.com.tw)

CR2025

■ Dimensions(mm)

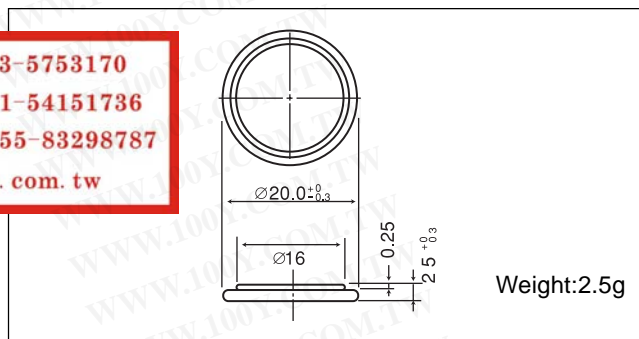

■ Specification

Nominal voltage (V)	3
Nominal capacity (mAh)	90
Continuous standard load (mA)	0.1
Operating temperature (C)	-30 ~ +60

■ Specification

Nominal voltage (V)	3
Nominal capacity (mAh)	165
Continuous standard load (mA)	0.2
Operating temperature (C)	-30 ~ +60

■ Temperature Characteristics

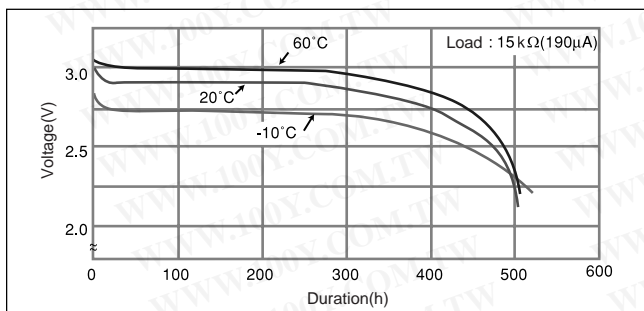

■ Temperature Characteristics

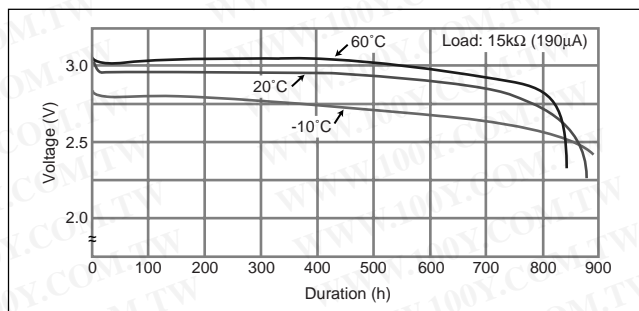

■ Operating voltage vs. load resistance (voltage at 50% discharge depth)

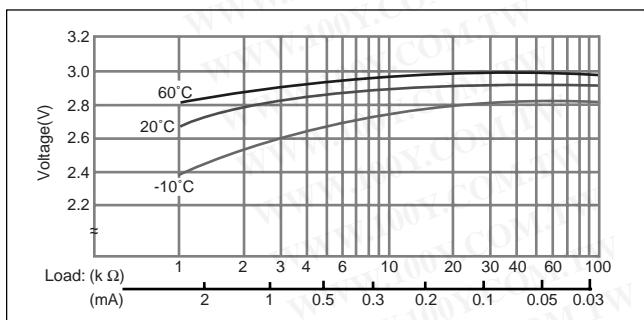

■ Operating voltage vs. load resistance (voltage at 50% discharge depth)

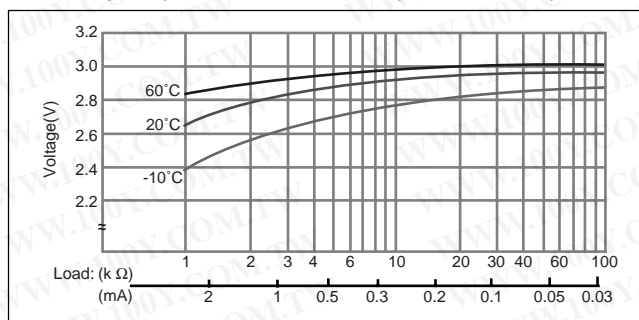

■ Capacity vs. load resistance

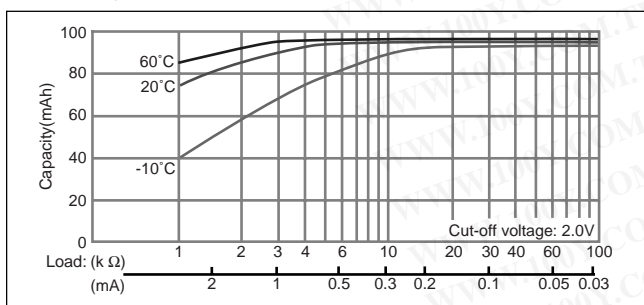

■ Capacity vs. load resistance

