

9000 Series/Spartan SIP Reed Relays

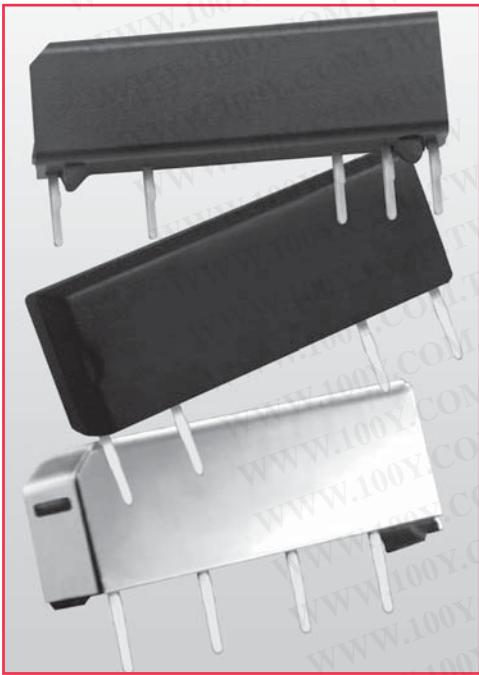

Economy SIP Reed Relays

The SIP relay is the industry choice for a wide variety of designs where economy, performance and a compact package are needed. The 9007 Spartan Series is a general purpose economy version of the 9001 for applications with less stringent requirements. The 9081 Spartan Series is similar to the 9007, but with alternate industry standard footprints to accommodate other options, including Form C types. These relays are well suited for applications in Security, Instrumentation and Modems. The specification tables allow you to select the appropriate relay for your application.

Series Features

- ◆ Hermetically sealed contacts for long life
- ◆ High dielectric strength available, consult factory
- ◆ High speed switching compared to electromechanical relays
- ◆ Molded thermoset body on integral lead frame design
- ◆ Form C available (9081C)
- ◆ Optional Coil Suppression Diode - protects coil drive circuits
- ◆ UL File # E67117, CSA File # LR 28537

勝特力材料 886-3-5753170
 勝特力电子(上海) 86-21-54151736
 勝特力电子(深圳) 86-755-83298787
[Http://www.100y.com.tw](http://www.100y.com.tw)

Dimensions in Inches (Millimeters)

Model 9081

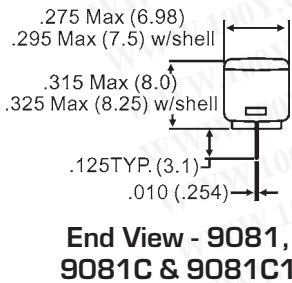
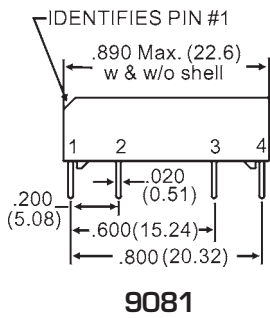

Model 9007

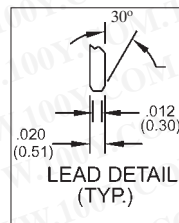
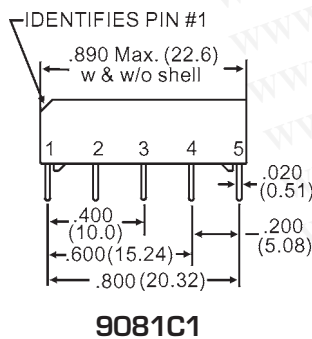
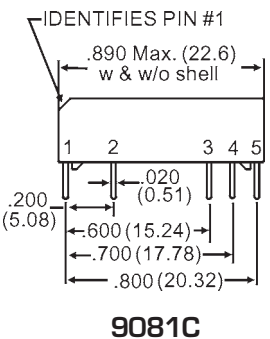
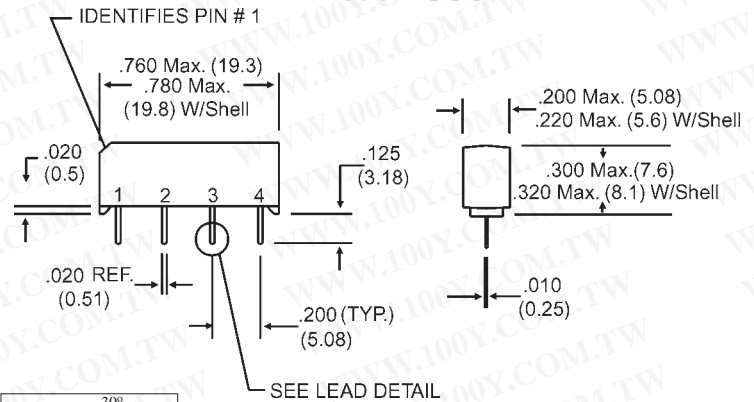

Ordering Information

Part Number	90XX-XX-XX
Model Number	9007 9081 9081C 9081C1
Coil Voltage	05 = 5 volts 12 = 12 volts 24 = 24 volts
Magnetic Shield Option	0 = No Shield 1 = Shield (External) 4 = High-Sensitivity Coil w/Mag. Shield (5V & 12V only); N/A 9081C 5 = High-Sensitivity Coil w/o Mag. Shield (12V only); N/A 9081C
General Options	0 = No Diode 1 = Diode ² (9007 Only) 2 = Form B Contacts (Normally Closed ³) (Available on 5V only)

9000 Series/Spartan SIP Reed Relays



Model Number			9007 ²			9081			9081C		
Parameters	Test Conditions	Units	.2 -.2 -.2 SIP			.2 -.4 -.2 SIP			.2 -.2 -.2 -.2 SIP		
COIL SPECS.											
Nom. Coil Voltage		VDC	5	12	24	5	12	24	5	12	24
Max. Coil Voltage		VDC	6.5	15.0	32.0	6.5	15.0	32.0	6.5	15.0	32.0
Coil Resistance (standard)	+/- 10%, 25° C	Ω	500	1000	2000	500	1000	2000	125	500	2000
Coil Resistance (hi-sensitivity)		Ω	1000	2000	--	1000	2000	--	--	--	--
Operate Voltage	Must Operate by	VDC - Max.	3.75	9.0	18.0	3.75	9.0	18.0	3.75	9.0	18.0
Release Voltage	Must Release by	VDC - Min.	0.4	1.0	2.0	0.4	1.0	2.0	0.4	1.0	2.0
CONTACT RATINGS											
Switching Voltage	Max DC/Peak AC Resist.	Volts	200			200			175		
Switching Current	Max DC/Peak AC Resist.	Amps	0.5			0.5			0.4		
Carry Current	Max DC/Peak AC Resist.	Amps	1.0			1.0			1.0		
Contact Rating	Max DC/Peak AC Resist.	Watts	10			10			5		
Life Expectancy-Typical ¹	Signal Level 1.0V, 10.0mA	x 10 ⁶ Ops.	100			100			100		
Static Contact Resistance (max. init.)	50mV, 10mA	Ω	0.200			0.200			0.200		
Dynamic Contact Resistance (max. init.)	0.5V, 50mA at 100 Hz, 1.5 msec	Ω	N/A			N/A			N/A		
RELAY SPECIFICATIONS											
Insulation Resistance (minimum)	Between all Isolated Pins at 100V, 25°C, 40% RH	Ω	10 ¹⁰			10 ¹⁰			10 ¹⁰		
Capacitance - Typical Across Open Contacts	No Shield	pF	0.7			0.7			0.7		
	Shield Floating	pF	-			-			-		
	Shield Guarding	pF	-			-			-		
Open Contact to Coil	No Shield	pF	1.4			1.4			1.4		
	Shield Floating	pF	-			-			-		
	Shield Guarding	pF	-			-			-		
Contact to Shield	Contacts Open, Shield Floating	pF	-			-			-		
Dielectric Strength (minimum)	Between Contacts	VDC/peak AC	250			250			200		
	Contacts to Shield	VDC/peak AC	-			-			-		
	Contacts/Shield to Coil	VDC/peak AC	1500			1500			1500		
Operate Time - including bounce - Typical	At Nominal Coil Voltage, 30 Hz Square Wave	msec.	0.50			0.50			1.0		
Release Time - Typical	Zener-Diode Suppression ⁴	msec.	0.20			0.20			1.5		

Top View:
 Dot stamped on top of relay refers to pin #1 location. Grid = .1"x.1" (2.54mm x 2.54mm)

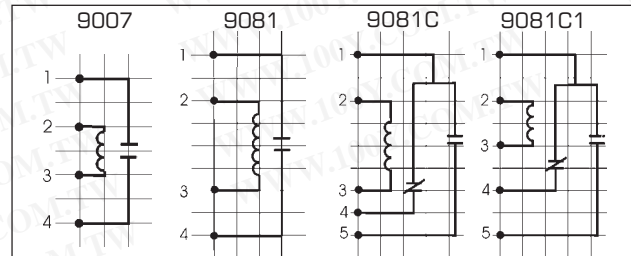

Notes:

- ¹ Consult factory for life expectancy at other switching loads.
- ² Optional diode is connected to pin #2 (+) and pin #3(-). Correct coil polarity must be observed.
- ³ These relays contain bias magnets. Correct coil polarity must be observed. Pin #2(+)
- ⁴ Consists of 56V Zener diode and 1N4148 diode in series, connected in parallel with coil.

Environmental Ratings

Storage Temp: -35°C to +100°C;
 Operating Temp: -20°C to +85°C
 Solder Temp: 270°C max; 10 sec. max
 The operate and release voltage and the coil resistance are specified at 25°C. These values vary by approximately 0.4% / °C as the ambient temperature varies.
 Vibration: 20 G's to 2000 Hz; Shock: 50 G's