

### SIPMOS® Power Transistor

- N channel
- Enhancement mode
- Avalanche-rated
- Logic Level
- $dv/dt$  rated
- Low on-resistance
- 175 °C operating temperature
- also in TO-220 SMD available

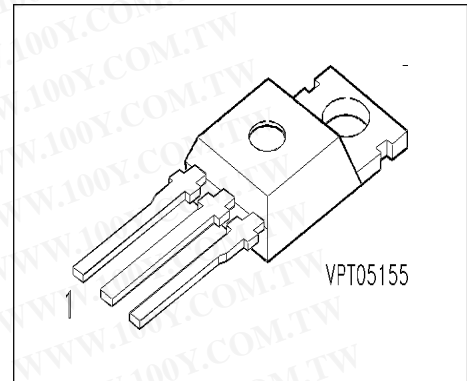

Pin 1	Pin 2	Pin 3
G	D	S

Type	$V_{DS}$	$I_D$	$R_{DS(on)}$	Package	Ordering Code
BUZ 104L	50 V	17.5 A	0.1 $\Omega$	TO-220 AB	C67078-S1358-A2

### Maximum Ratings

Parameter	Symbol	Values	Unit
Continuous drain current $T_C = 29\text{ }^\circ\text{C}$	$I_D$	17.5	A
Pulsed drain current $T_C = 25\text{ }^\circ\text{C}$	$I_{Dpuls}$	70	
Avalanche energy, single pulse $I_D = 17.5\text{ A}$ , $V_{DD} = 25\text{ V}$ , $R_{GS} = 25\text{ }\Omega$ $L = 114\text{ }\mu\text{H}$ , $T_j = 25\text{ }^\circ\text{C}$	$E_{AS}$	35	mJ
Reverse diode $dv/dt$ $I_S = 17.5\text{ A}$ , $V_{DS} = 40\text{ V}$ , $di_f/dt = 200\text{ A}/\mu\text{s}$ $T_{jmax} = 175\text{ }^\circ\text{C}$	$dv/dt$	6	kV/ $\mu\text{s}$
Gate source voltage	$V_{GS}$	$\pm 14$	V
Gate-source peak voltage,aperiodic	$V_{gs}$	$\pm 20$	
Power dissipation $T_C = 25\text{ }^\circ\text{C}$	$P_{tot}$	60	W

### Maximum Ratings

Parameter	Symbol	Values	Unit
Operating temperature	$T_j$	-55 ... + 175	°C
Storage temperature	$T_{stg}$	-55 ... + 175	
Thermal resistance, chip case	$R_{thJC}$	≤ 2.5	K/W
Thermal resistance, chip to ambient	$R_{thJA}$	≤ 75	
DIN humidity category, DIN 40 040		E	
IEC climatic category, DIN IEC 68-1		55 / 175 / 56	

### Electrical Characteristics, at $T_j = 25^\circ\text{C}$ , unless otherwise specified

Parameter	Symbol	Values			Unit
		min.	typ.	max.	

### Static Characteristics

Drain- source breakdown voltage $V_{GS} = 0\text{ V}, I_D = 0.25\text{ mA}, T_j = -40^\circ\text{C}$	$V_{(BR)DSS}$	50	-	-	V
Gate threshold voltage $V_{GS} = V_{DS}, I_D = 1\text{ mA}$	$V_{GS(th)}$	1.2	1.6	2	
Zero gate voltage drain current $V_{DS} = 50\text{ V}, V_{GS} = 0\text{ V}, T_j = 25^\circ\text{C}$	$I_{DSS}$	-	0.1	1	μA
$V_{DS} = 50\text{ V}, V_{GS} = 0\text{ V}, T_j = -40^\circ\text{C}$		-	1	100	nA
$V_{DS} = 50\text{ V}, V_{GS} = 0\text{ V}, T_j = 150^\circ\text{C}$		-	10	100	μA
Gate-source leakage current $V_{GS} = 20\text{ V}, V_{DS} = 0\text{ V}$	$I_{GSS}$	-	10	100	nA
Drain-Source on-resistance $V_{GS} = 5\text{ V}, I_D = 8.5\text{ A}$	$R_{DS(on)}$	-	0.085	0.1	Ω

### Electrical Characteristics, at $T_j = 25^\circ\text{C}$ , unless otherwise specified

Parameter	Symbol	Values			Unit
		min.	typ.	max.	

#### Dynamic Characteristics

Transconductance $V_{DS} \geq 2 * I_D * R_{DS(on)max}, I_D = 8.5 \text{ A}$	$g_{fs}$	5	9.2	-	S
Input capacitance $V_{GS} = 0 \text{ V}, V_{DS} = 25 \text{ V}, f = 1 \text{ MHz}$	$C_{iss}$	-	420	560	pF
Output capacitance $V_{GS} = 0 \text{ V}, V_{DS} = 25 \text{ V}, f = 1 \text{ MHz}$	$C_{oss}$	-	140	210	
Reverse transfer capacitance $V_{GS} = 0 \text{ V}, V_{DS} = 25 \text{ V}, f = 1 \text{ MHz}$	$C_{rss}$	-	60	90	
Turn-on delay time $V_{DD} = 30 \text{ V}, V_{GS} = 5 \text{ V}, I_D = 3 \text{ A}$ $R_{GS} = 50 \Omega$	$t_{d(on)}$	-	12	18	ns
Rise time $V_{DD} = 30 \text{ V}, V_{GS} = 5 \text{ V}, I_D = 3 \text{ A}$ $R_{GS} = 50 \Omega$	$t_r$	-	50	75	
Turn-off delay time $V_{DD} = 30 \text{ V}, V_{GS} = 5 \text{ V}, I_D = 3 \text{ A}$ $R_{GS} = 50 \Omega$	$t_{d(off)}$	-	70	95	ns
Fall time $V_{DD} = 30 \text{ V}, V_{GS} = 5 \text{ V}, I_D = 3 \text{ A}$ $R_{GS} = 50 \Omega$	$t_f$	-	50	65	

**Electrical Characteristics, at  $T_j = 25^\circ\text{C}$ , unless otherwise specified**

Parameter	Symbol	Values			Unit
		min.	typ.	max.	
<b>Reverse Diode</b>					
Inverse diode continuous forward current $T_C = 25^\circ\text{C}$	$I_S$	-	-	17.5	A
Inverse diode direct current, pulsed $T_C = 25^\circ\text{C}$	$I_{SM}$	-	-	70	A
Inverse diode forward voltage $V_{GS} = 0\text{ V}, I_F = 35\text{ A}$	$V_{SD}$	-	1.15	1.8	V
Reverse recovery time $V_R = 30\text{ V}, I_F = I_S, di_F/dt = 100\text{ A}/\mu\text{s}$	$t_{rr}$	-	55	-	ns
Reverse recovery charge $V_R = 30\text{ V}, I_F = I_S, di_F/dt = 100\text{ A}/\mu\text{s}$	$Q_{rr}$	-	25	-	nC

### Power dissipation

$$P_{\text{tot}} = f(T_C)$$

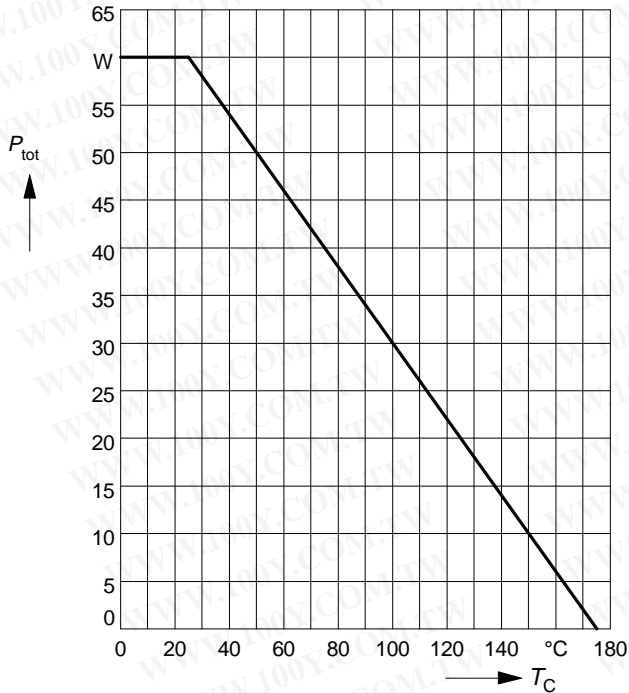

### Drain current

$$I_D = f(T_C)$$

parameter:  $V_{GS} \geq 5 \text{ V}$

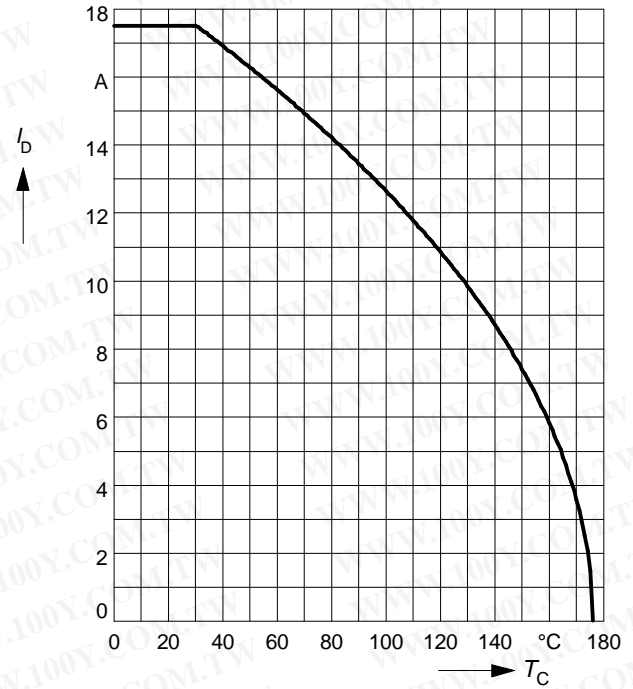

### Safe operating area

$$I_D = f(V_{DS})$$

parameter:  $D = 0, T_C = 25^\circ\text{C}$

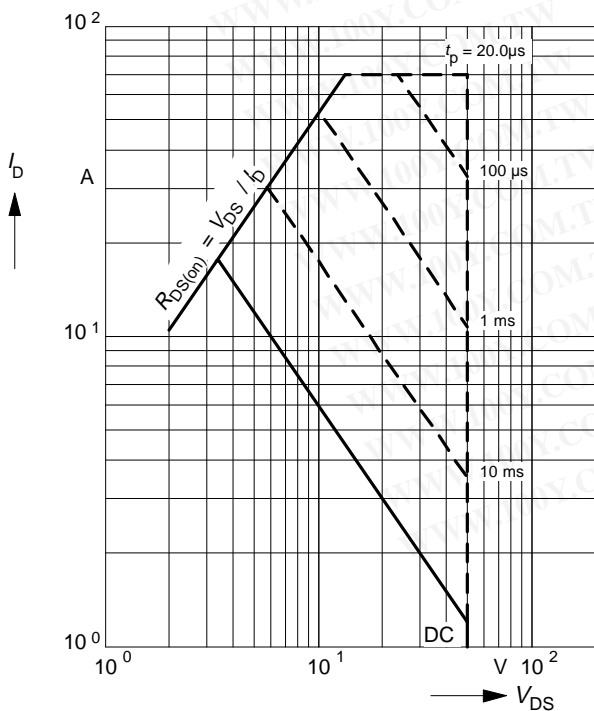

### Transient thermal impedance

$$Z_{\text{thJC}} = f(t_p)$$

parameter:  $D = t_p / T$

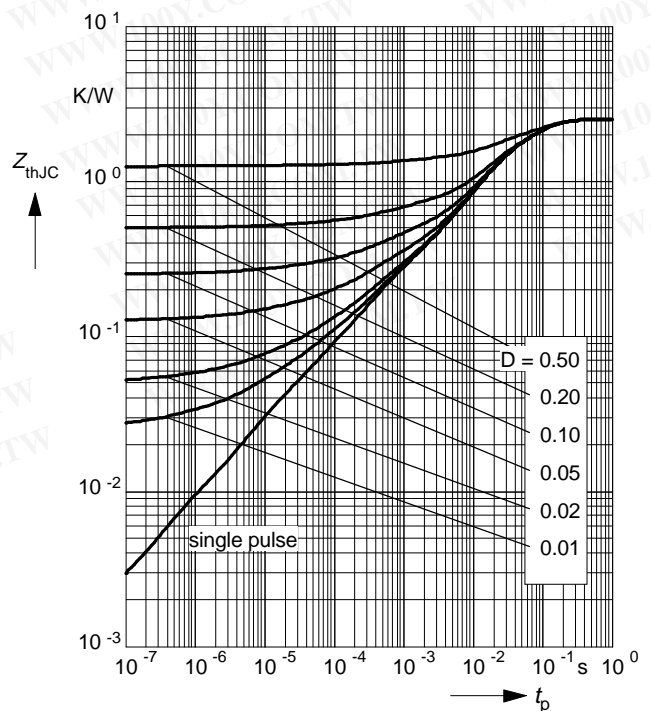

### Typ. output characteristics

$$I_D = f(V_{DS})$$

parameter:  $t_p = 80 \mu s$

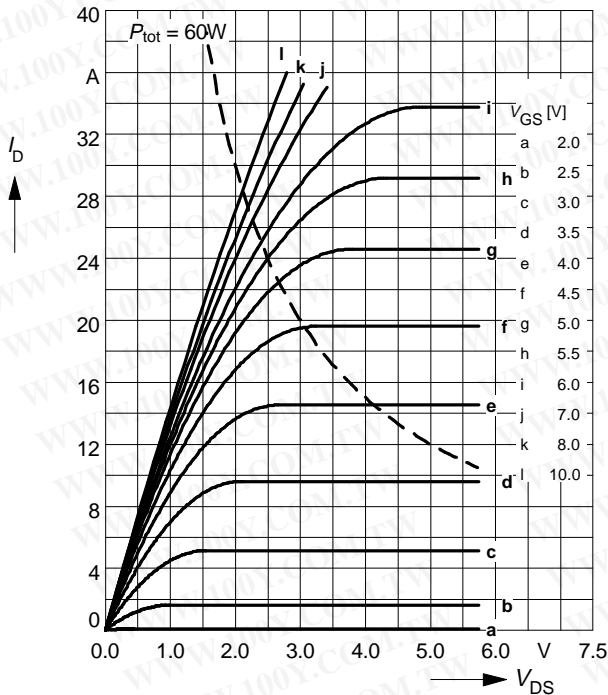

### Drain-source on-resistance

$$R_{DS(on)} = f(T_j)$$

parameter:  $I_D = 8.5 A, V_{GS} = 5 V$

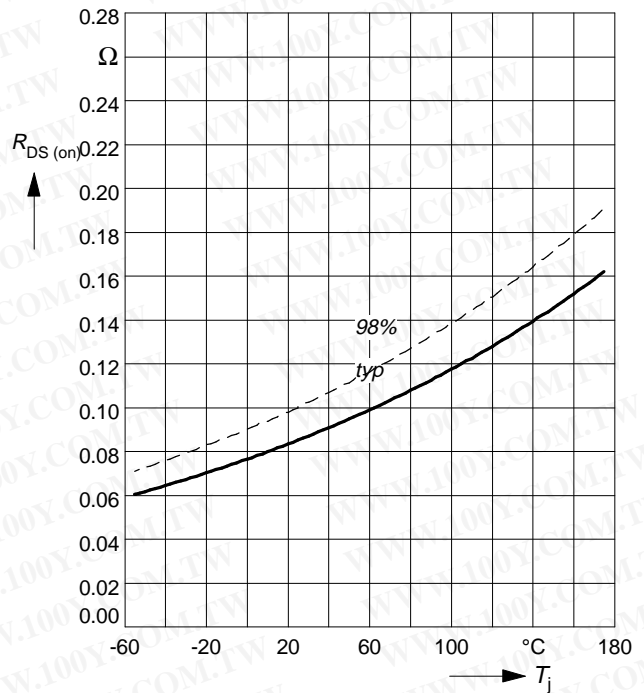

### Typ. transfer characteristics $I_D = f(V_{GS})$

parameter:  $t_p = 80 \mu s$

$V_{DS} \geq 2 \times I_D \times R_{DS(on)max}$

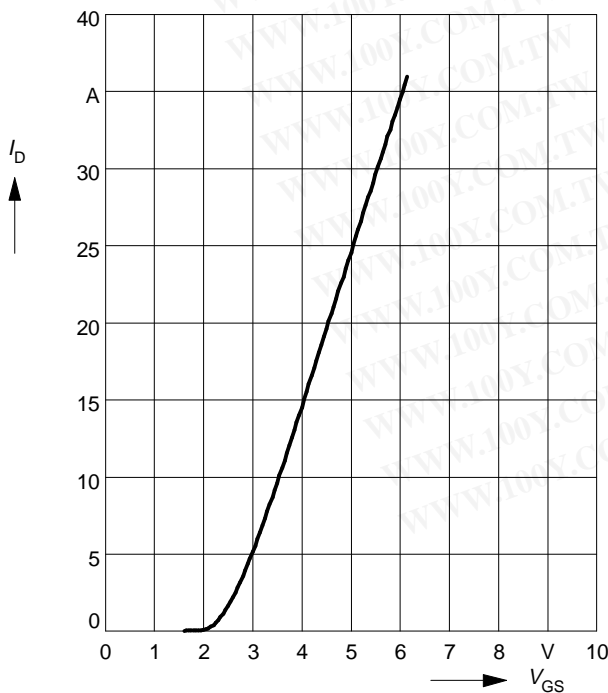

### Typ. forward transconductance $g_{fs} = f(I_D)$

parameter:  $t_p = 80 \mu s,$

$V_{DS} \geq 2 \times I_D \times R_{DS(on)max}$

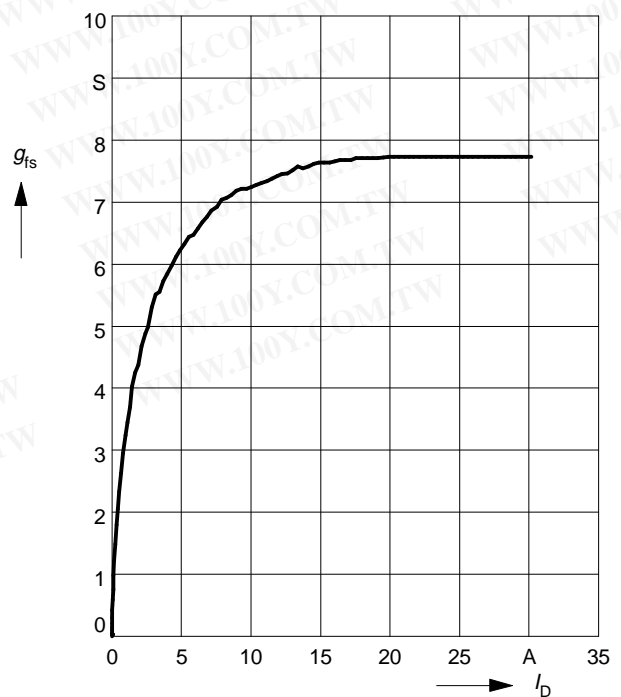

### Typ. drain-source on-resistance

$R_{DS(on)} = f(I_D)$   
 parameter:  $V_{GS}$

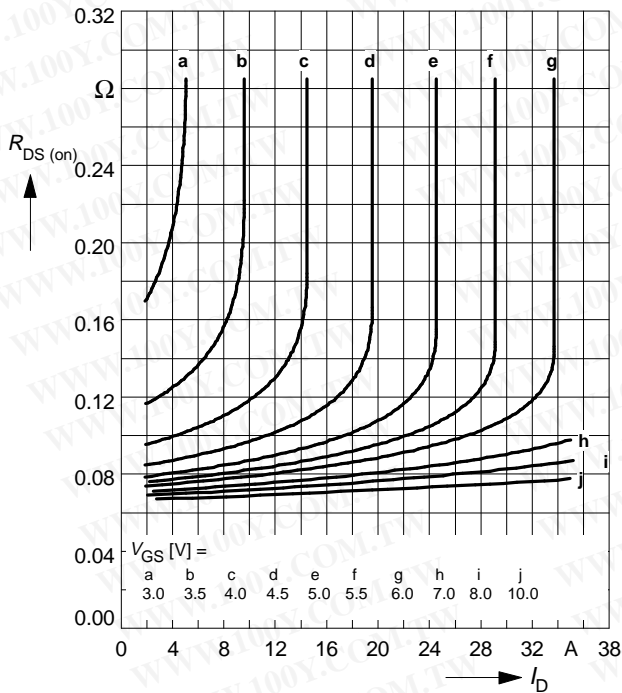

### Gate threshold voltage

$V_{GS(th)} = f(T_j)$   
 parameter:  $V_{GS} = V_{DS}, I_D = 1 \text{ mA}$

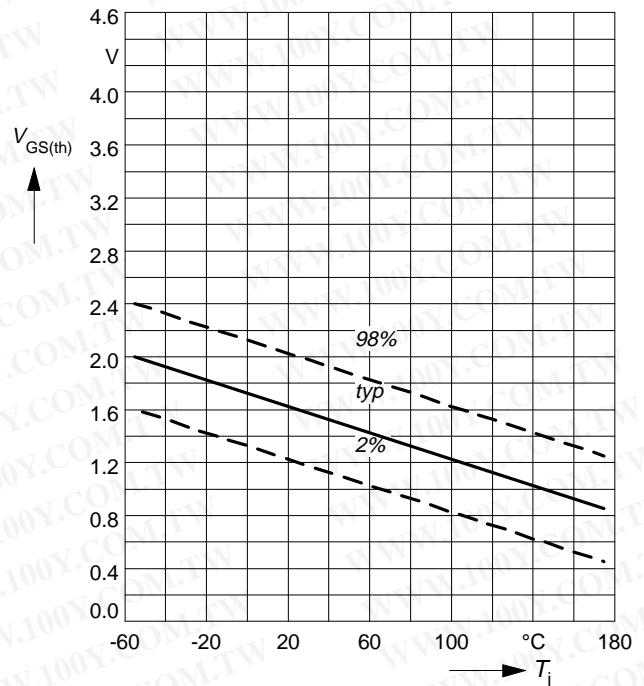

### Typ. capacitances

$C = f(V_{DS})$   
 parameter:  $V_{GS} = 0V, f = 1\text{MHz}$

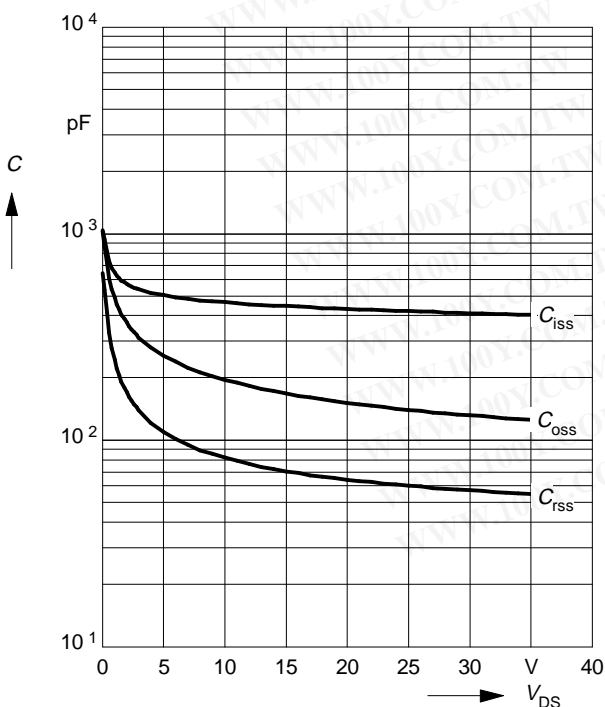

### Forward characteristics of reverse diode

$I_F = f(V_{SD})$   
 parameter:  $T_j, t_p = 80 \mu\text{s}$

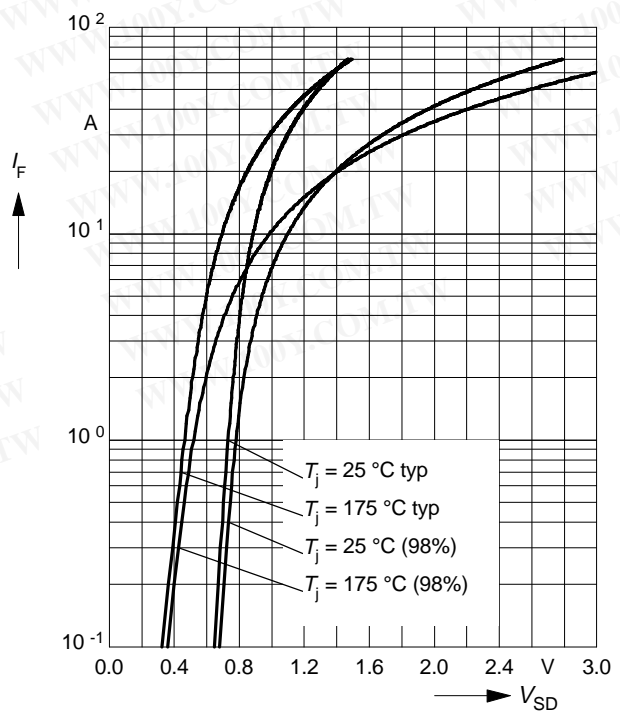

### Avalanche energy $E_{AS} = f(T_j)$

parameter:  $I_D = 17.5 \text{ A}$ ,  $V_{DD} = 25 \text{ V}$

$R_{GS} = 25 \Omega$ ,  $L = 114 \mu\text{H}$

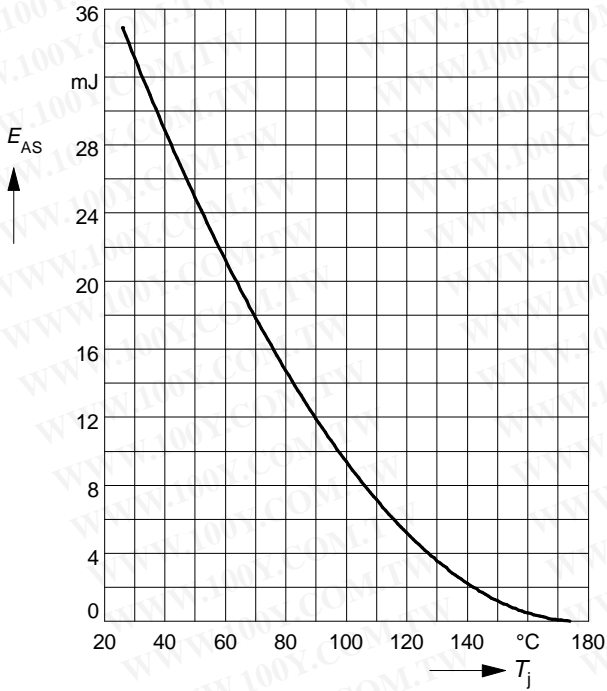

### Typ. gate charge

$V_{GS} = f(Q_{\text{Gate}})$

parameter:  $I_{D \text{ puls}} = 26 \text{ A}$

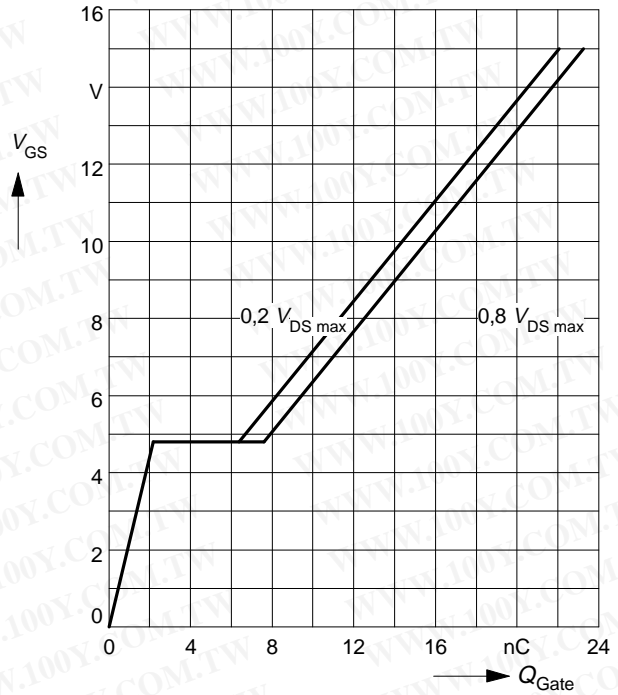

### Drain-source breakdown voltage

$V_{(BR)DSS} = f(T_j)$

