

MOSPEC

COMPLEMENTARY SILICON PLASTIC POWER TRANSISTORS

... designed for use in general purpose power amplifier and switching applications.

FEATURES:

* Collector-Emitter Sustaining Voltage -

- $V_{CEO(sus)}$ = 45V(Min)- BD905, BD906
- 60V(Min)- BD907, BD908
- 80V(Min)- BD909, BD910
- 100V(Min)- BD911, BD912

* DC Current Gain $hFE = 40(\text{Min}) @ I_C = 0.5A$

* Current Gain-Bandwidth Product $fT = 3.0 \text{ MHz}(\text{Min}) @ I_C = 500mA$

NPN	PNP
BD905	BD906
BD907	BD908
BD909	BD910
BD911	BD912

15 AMPERE
COMPLEMENTARY SILICON
POWER TRANSISTORS
45 -100 VOLTS
90 WATTS

MAXIMUM RATINGS

Characteristic	Symbol	BD905 BD906	BD907 BD908	BD909 BD910	BD911 BD912	Unit
Collector-Emitter Voltage	V_{CEO}	45	60	80	100	V
Collector-Base Voltage	V_{CBO}	45	60	80	100	V
Emitter-Base Voltage	V_{EBO}	5.0				V
Collector Current - Continuous - Peak	I_C	15 20				A
Base Current	I_B	5.0				A
Total Power Dissipation @ $T_C = 25^\circ C$ Derate above $25^\circ C$	P_D	90 0.72				W W/ $^\circ C$
Operating and Storage Junction Temperature Range	T_J, T_{STG}	-65 to +150				$^\circ C$

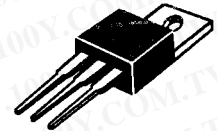

TO-220

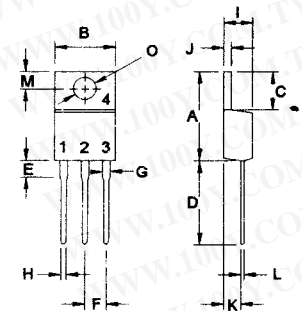

PIN 1.BASE
2.COLLECTOR
3.EMITTER
4.COLLECTOR(CASE)

THERMAL CHARACTERISTICS

Characteristic	Symbol	Max	Unit
Thermal Resistance Junction to Case	$R_{\theta jc}$	1.38	$^\circ C/W$

DIM	MILLIMETERS	
	MIN	MAX
A	14.68	15.31
B	9.78	10.42
C	5.01	6.52
D	13.06	14.62
E	3.57	4.07
F	2.42	3.66
G	1.12	1.36
H	0.72	0.96
I	4.22	4.98
J	1.14	1.38
K	2.20	2.97
L	0.33	0.55
M	2.48	2.98
O	3.70	3.90

FIGURE -1 POWER DERATING

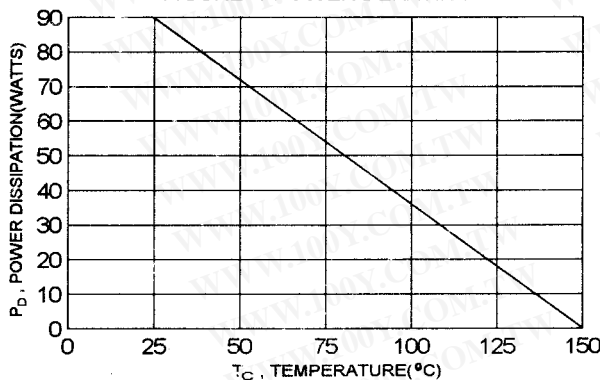

BD905, BD907, BD909, BD911 NPN / BD906, BD908, BD810, BD912 PNP

ELECTRICAL CHARACTERISTICS ($T_c = 25^\circ\text{C}$ unless otherwise noted)

Characteristic	Symbol	Min	Max	Unit
----------------	--------	-----	-----	------

OFF CHARACTERISTICS

Collector-Emitter Sustaining Voltage(1) ($I_C = 50\text{ mA}$, $I_B = 0$)	BD905, BD906 BD907, BD908 BD909, BD910 BD911, BD912	$V_{CEO(sus)}$	45 60 80 100	V
Collector Cutoff Current ($V_{CE} = 30\text{ V}$, $I_B = 0$) ($V_{CE} = 30\text{ V}$, $I_B = 0$) ($V_{CE} = 40\text{ V}$, $I_B = 0$) ($V_{CE} = 50\text{ V}$, $I_B = 0$)	BD905, BD906 BD907, BD908 BD909, BD910 BD911, BD912	I_{CEO}	1.0 1.0 1.0 1.0	mA
Collector Cutoff Current ($V_{CB} = 45\text{ V}$, $I_E = 0$) ($V_{CB} = 60\text{ V}$, $I_E = 0$) ($V_{CB} = 80\text{ V}$, $I_E = 0$) ($V_{CB} = 100\text{ V}$, $I_E = 0$)	BD905, BD906 BD907, BD908 BD909, BD910 BD911, BD912	I_{CBO}	0.5 0.5 0.5 0.5	mA
Emitter Cutoff Current ($V_{EB} = 5.0\text{ V}$, $I_C = 0$)		I_{EBO}	1.0	mA

ON CHARACTERISTICS (1)

DC Current Gain ($I_C = 0.5\text{ A}$, $V_{CE} = 4.0\text{ V}$) ($I_C = 5.0\text{ A}$, $V_{CE} = 4.0\text{ V}$) ($I_C = 10\text{ A}$, $V_{CE} = 4.0\text{ V}$)	h_{FE}	40 15 5.0	250 150	
Collector-Emitter Saturation Voltage ($I_C = 5.0\text{ A}$, $I_B = 0.5\text{ A}$) ($I_C = 10\text{ A}$, $I_B = 2.5\text{ A}$)	$V_{CE(sat)}$		1.0 3.0	V
Base-Emitter Saturation Voltage ($I_C = 10\text{ A}$, $I_B = 2.5\text{ A}$)	$V_{BE(sat)}$		2.5	V
Base-Emitter On Voltage ($I_C = 5.0\text{ A}$, $V_{CE} = 4.0\text{ V}$)	$V_{BE(on)}$		1.5	V

DYNAMIC CHARACTERISTICS

Current Gain-Bandwidth Product (2) ($I_C = 500\text{ mA}$, $V_{CE} = 4.0\text{ V}$, $f = 1\text{ MHz}$)	f_T	3.0		MHz
--	-------	-----	--	-----

(1) Pulse Test: Pulse width = 300 us , Duty Cycle $\leq 2.0\%$

(2) $f_T = |h_{fe}| \cdot f_{test}$

BD905, BD907, BD909, BD911 NPN / BD906, BD908, BD910, BD912 PNP

DC CURRENT GAIN

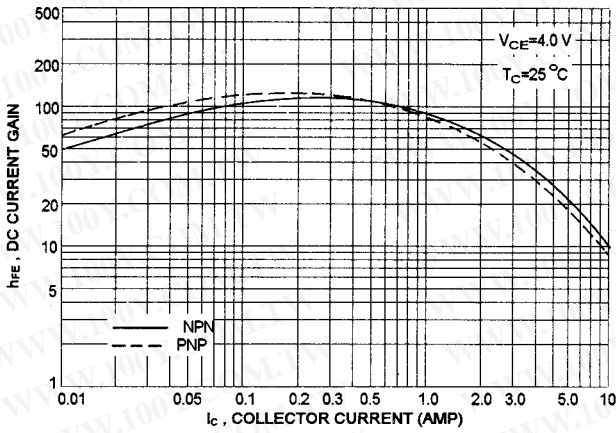

$f_T - I_C$

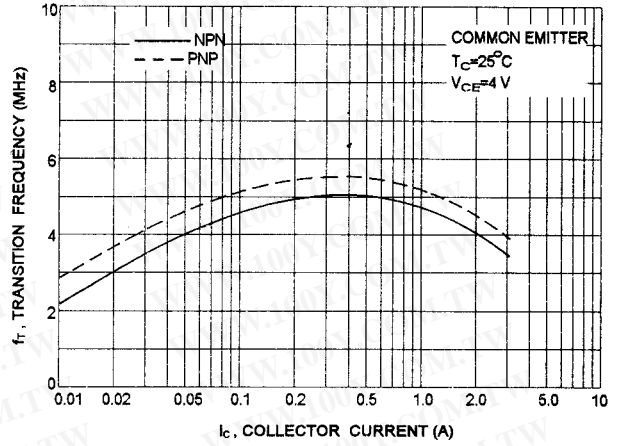

"ON" VOLTAGES

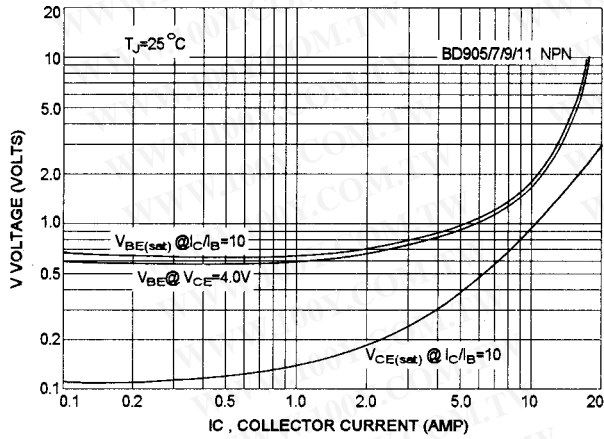

COLLECTOR-BASE CAPACITANCES

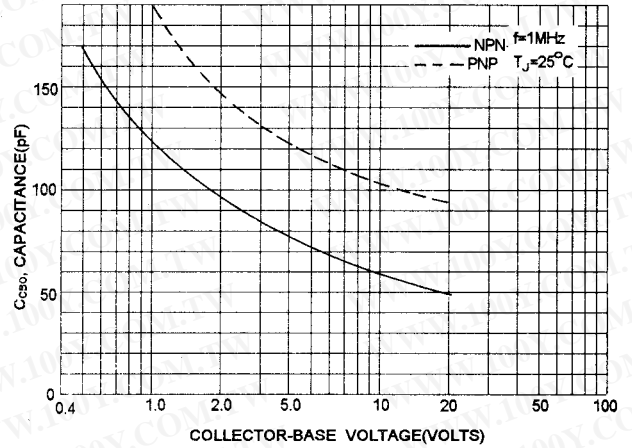

"ON" VOLTAGES

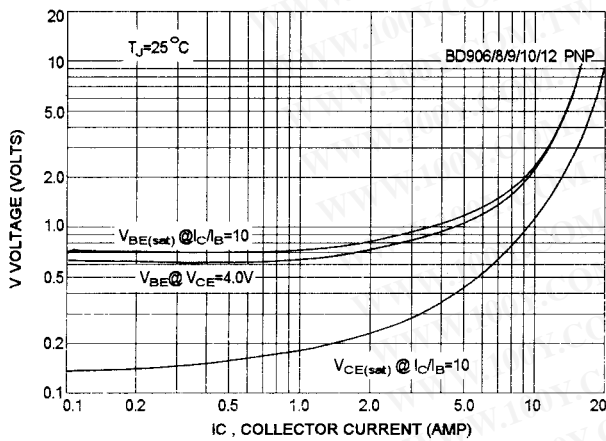

ACTIVE REGION SAFE OPERATING AREA(SOA)

