



勝特力材料 886-3-5753170
 勝特力电子(上海) 86-21-54151736
 勝特力电子(深圳) 86-755-83298787
 Http://www.100y.com.tw

High Performance Video Op Amp

AD811

FEATURES

High Speed

- 140 MHz Bandwidth (3 dB, G = +1)
- 120 MHz Bandwidth (3 dB, G = +2)
- 35 MHz Bandwidth (0.1 dB, G = +2)
- 2500 V/ μ s Slew Rate
- 25 ns Settling Time to 0.1% (For a 2 V Step)
- 65 ns Settling Time to 0.01% (For a 10 V Step)

Excellent Video Performance ($R_L = 150 \Omega$)

- 0.01% Differential Gain, 0.01° Differential Phase
- Voltage Noise of 1.9 nV/ $\sqrt{\text{Hz}}$

Low Distortion: THD = -74 dB @ 10 MHz

Excellent DC Precision

- 3 mV max Input Offset Voltage

Flexible Operation

- Specified for ± 5 V and ± 15 V Operation
- ± 2.3 V Output Swing into a 75 Ω Load ($V_S = \pm 5$ V)

APPLICATIONS

- Video Crosspoint Switchers, Multimedia Broadcast Systems
- HDTV Compatible Systems
- Video Line Drivers, Distribution Amplifiers
- ADC/DAC Buffers
- DC Restoration Circuits
- Medical—Ultrasound, PET, Gamma and Counter Applications

PRODUCT DESCRIPTION

The AD811 is a wideband current-feedback operational amplifier, optimized for broadcast quality video systems. The -3 dB bandwidth of 120 MHz at a gain of +2 and differential gain and phase of 0.01% and 0.01° ($R_L = 150 \Omega$) make the AD811 an excellent choice for all video systems. The AD811 is designed to meet a stringent 0.1 dB gain flatness specification to a bandwidth of 35 MHz ($G = +2$) in addition to the low differential gain and phase errors. This performance is achieved whether driving one or two back terminated 75 Ω cables, with a low power supply current of 16.5 mA. Furthermore, the AD811 is specified over a power supply range of ± 4.5 V to ± 18 V.

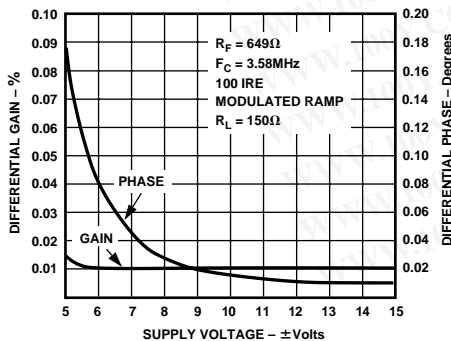

CONNECTION DIAGRAMS

8-Lead Plastic (N-8)

Cerdip (Q-8)

SOIC (SO-8) Packages

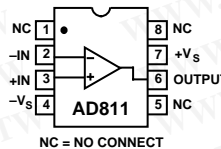

20-Lead LCC (E-20A) Package

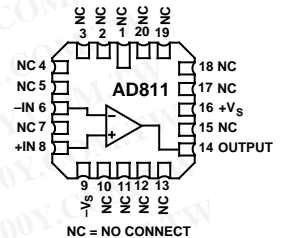

16-Lead SOIC (R-16) Package

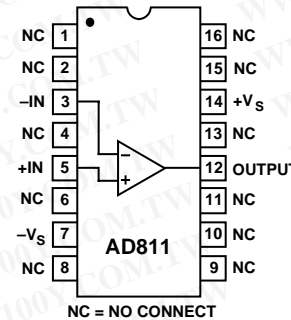

20-Lead SOIC (R-20) Package

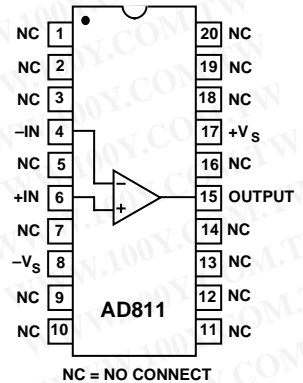

The AD811 is also excellent for pulsed applications where transient response is critical. It can achieve a maximum slew rate of greater than 2500 V/ μ s with a settling time of less than 25 ns to 0.1% on a 2 volt step and 65 ns to 0.01% on a 10 volt step.

The AD811 is ideal as an ADC or DAC buffer in data acquisition systems due to its low distortion up to 10 MHz and its wide unity gain bandwidth. Because the AD811 is a current feedback amplifier, this bandwidth can be maintained over a wide range of gains. The AD811 also offers low voltage and current noise of 1.9 nV/ $\sqrt{\text{Hz}}$ and 20 pA/ $\sqrt{\text{Hz}}$, respectively, and excellent dc accuracy for wide dynamic range applications.

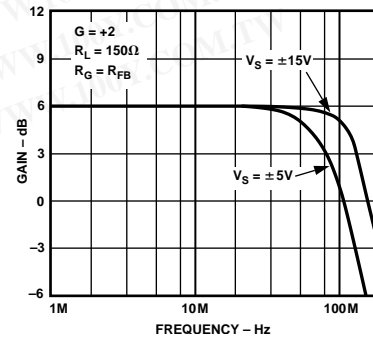

REV. D

Information furnished by Analog Devices is believed to be accurate and reliable. However, no responsibility is assumed by Analog Devices for its use, nor for any infringements of patents or other rights of third parties which may result from its use. No license is granted by implication or otherwise under any patent or patent rights of Analog Devices.

AD811—SPECIFICATIONS (@ T_A = +25°C and V_S = ±15 V dc, R_{LOAD} = 150 Ω unless otherwise noted)

Model	Conditions	V _S	AD811J/A ¹			AD811S ²			Units
			Min	Typ	Max	Min	Typ	Max	
DYNAMIC PERFORMANCE									
Small Signal Bandwidth (No Peaking)									
-3 dB									
G = +1	R _{FB} = 562 Ω	±15 V		140		140			MHz
G = +2	R _{FB} = 649 Ω	±15 V		120		120			MHz
G = +2	R _{FB} = 562 Ω	±5 V		80		80			MHz
G = +10	R _{FB} = 511 Ω	±15 V		100		100			MHz
0.1 dB Flat									
G = +2	R _{FB} = 562 Ω	±5 V		25		25			MHz
	R _{FB} = 649 Ω	±15 V		35		35			MHz
Full Power Bandwidth ³	V _{OUT} = 20 V p-p	±15 V		40		40			MHz
Slew Rate	V _{OUT} = 4 V p-p	±5 V		400		400			V/μs
	V _{OUT} = 20 V p-p	±15 V		2500		2500			V/μs
Settling Time to 0.1%	10 V Step, A _V = -1	±15 V		50		50			ns
Settling Time to 0.01%				65		65			ns
Settling Time to 0.1%	2 V Step, A _V = -1	±5 V		25		25			ns
Rise Time, Fall Time	R _{FB} = 649, A _V = +2	±15 V		3.5		3.5			ns
Differential Gain	f = 3.58 MHz	±15 V		0.01		0.01			%
Differential Phase	f = 3.58 MHz	±15 V		0.01		0.01			Degree
THD @ f _C = 10 MHz	V _{OUT} = 2 V p-p, A _V = +2	±15 V		-74		-74			dBc
Third Order Intercept ⁴	@ f _C = 10 MHz	±15 V		36		36			dBm
				43		43			dBm
INPUT OFFSET VOLTAGE									
Offset Voltage Drift	T _{MIN} to T _{MAX}	±5 V, ±15 V		0.5	3		0.5	3	mV
					5			5	mV
									μV/°C
INPUT BIAS CURRENT									
-Input		±5 V, ±15 V		2	5		2	5	μA
	T _{MIN} to T _{MAX}				15			30	μA
+Input		±5 V, ±15 V		2	10		2	10	μA
	T _{MIN} to T _{MAX}				20			25	μA
TRANSRESISTANCE									
	T _{MIN} to T _{MAX}								
	V _{OUT} = ±10 V								
	R _L = ∞	±15 V		0.75	1.5		0.75	1.5	MΩ
	R _L = 200 Ω	±15 V		0.5	0.75		0.5	0.75	MΩ
	V _{OUT} = ±2.5 V								
	R _L = 150 Ω	±5 V		0.25	0.4		0.125	0.4	MΩ
COMMON-MODE REJECTION									
V _{OS} (vs. Common Mode)									
T _{MIN} to T _{MAX}	V _{CM} = ±2.5	±5 V		56	60		50	60	dB
T _{MIN} to T _{MAX}	V _{CM} = ±10 V	±15 V		60	66		56	66	dB
Input Current (vs. Common Mode)	T _{MIN} to T _{MAX}			1	3		1	3	μA/V
POWER SUPPLY REJECTION									
V _{OS}	V _S = ±4.5 V to ±18 V			60	70		60	70	dB
+Input Current	T _{MIN} to T _{MAX}				0.3	2		0.3	2
-Input Current	T _{MIN} to T _{MAX}				0.4	2		0.4	2
									μA/V
INPUT VOLTAGE NOISE									
	f = 1 kHz				1.9			1.9	nV/√Hz
INPUT CURRENT NOISE									
	f = 1 kHz				20			20	pA/√Hz
OUTPUT CHARACTERISTICS									
Voltage Swing, Useful Operating Range ⁵		±5 V		±2.9		±2.9			V
		±15 V		±12		±12			V
Output Current	T _J = +25°C			100		100			mA
Short-Circuit Current				150		150			mA
Output Resistance	(Open Loop @ 5 MHz)			9		9			Ω
INPUT CHARACTERISTICS									
+Input Resistance				1.5		1.5			MΩ
-Input Resistance				14		14			Ω
Input Capacitance	+Input			7.5		7.5			pF
Common-Mode Voltage Range		±5 V		±3		±3			V
		±15 V		±13		±13			V
POWER SUPPLY									
Operating Range				±4.5	±18		±4.5	±18	V
Quiescent Current		±5 V		14.5	16.0		14.5	16.0	mA
		±15 V		16.5	18.0		16.5	18.0	mA
TRANSISTOR COUNT									
	# of Transistors			40		40			

NOTES

¹The AD811JR is specified with ±5 V power supplies only, with operation up to ±12 volts.

²See Analog Devices' military data sheet for 883B tested specifications.

³FPBW = slew rate/(2π V_{PEAK}).

⁴Output power level, tested at a closed loop gain of two.

⁵Useful operating range is defined as the output voltage at which linearity begins to degrade.

Specifications subject to change without notice.

勝特力材料 886-3-5753170
勝特力电子(上海) 86-21-54151736
勝特力电子(深圳) 86-755-83298787
[Http://www.100y.com.tw](http://www.100y.com.tw)

ABSOLUTE MAXIMUM RATINGS¹

Supply Voltage ±18 V
 AD811JR Grade Only ±12 V
 Internal Power Dissipation² Observe Derating Curves
 Output Short Circuit Duration Observe Derating Curves
 Common-Mode Input Voltage ±V_S
 Differential Input Voltage ±6 V
 Storage Temperature Range (Q, E) -65°C to +150°C
 Storage Temperature Range (N, R) -65°C to +125°C
 Operating Temperature Range
 AD811J 0°C to +70°C
 AD811A -40°C to +85°C
 AD811S -55°C to +125°C
 Lead Temperature Range (Soldering 60 sec) +300°C

NOTES

¹Stresses above those listed under Absolute Maximum Ratings may cause permanent damage to the device. This is a stress rating only; functional operation of the device at these or any other conditions above those indicated in the operational section of this specification is not implied. Exposure to absolute maximum rating conditions for extended periods may affect device reliability.

- ²8-Lead Plastic Package: θ_{JA} = 90°C/W
 8-Lead Cerdip Package: θ_{JA} = 110°C/W
 8-Lead SOIC Package: θ_{JA} = 155°C/W
 16-Lead SOIC Package: θ_{JA} = 85°C/W
 20-Lead SOIC Package: θ_{JA} = 80°C/W
 20-Lead LCC Package: θ_{JA} = 70°C/W

ORDERING GUIDE

Model	Temperature Range	Package Option*
AD811AN	-40°C to +85°C	N-8
AD811AR-16	-40°C to +85°C	R-16
AD811AR-20	-40°C to +85°C	R-20
AD811JR	0°C to +70°C	SO-8
AD811SQ/883B	-55°C to +125°C	Q-8
5962-9313101MPA	-55°C to +125°C	Q-8
AD811SE/883B	-55°C to +125°C	E-20A
5962-9313101M2A	-55°C to +125°C	E-20A
AD811JR-REEL	0°C to +70°C	SO-8
AD811JR-REEL7	0°C to +70°C	SO-8
AD811AR-16-REEL	-40°C to +85°C	R-16
AD811AR-16-REEL7	-40°C to +85°C	R-16
AD811AR-20-REEL	-40°C to +85°C	R-20
AD811ACHIPS	-40°C to +85°C	Die
AD811SCHIPS	-55°C to +125°C	Die

*E = Ceramic Leadless Chip Carrier; N = Plastic DIP; Q = Cerdip; SO (R) = Small Outline IC (SOIC).

CAUTION

ESD (electrostatic discharge) sensitive device. Electrostatic charges as high as 4000 V readily accumulate on the human body and test equipment and can discharge without detection. Although the AD811 features proprietary ESD protection circuitry, permanent damage may occur on devices subjected to high energy electrostatic discharges. Therefore, proper ESD precautions are recommended to avoid performance degradation or loss of functionality.

MAXIMUM POWER DISSIPATION

The maximum power that can be safely dissipated by the AD811 is limited by the associated rise in junction temperature. For the plastic packages, the maximum safe junction temperature is +145°C. For the cerdip and LCC packages, the maximum junction temperature is +175°C. If these maximums are exceeded momentarily, proper circuit operation will be restored as soon as the die temperature is reduced. Leaving the device in the “overheated” condition for an extended period can result in device burnout. To ensure proper operation, it is important to observe the derating curves in Figures 17 and 18.

While the AD811 is internally short circuit protected, this may not be sufficient to guarantee that the maximum junction temperature is not exceeded under all conditions. One important example is when the amplifier is driving a reverse terminated 75 Ω cable and the cable’s far end is shorted to a power supply. With power supplies of ±12 volts (or less) at an ambient temperature of +25°C or less, if the cable is shorted to a supply rail, then the amplifier will not be destroyed, even if this condition persists for an extended period.

ESD SUSCEPTIBILITY

ESD (electrostatic discharge) sensitive device. Electrostatic charges as high as 4000 volts, which readily accumulate on the human body and on test equipment, can discharge without detection. Although the AD811 features proprietary ESD protection circuitry, permanent damage may still occur on these devices if they are subjected to high energy electrostatic discharges. Therefore, proper ESD precautions are recommended to avoid any performance degradation or loss of functionality.

METALIZATION PHOTOGRAPH

Contact Factory for Latest Dimensions.
 Dimensions Shown in Inches and (mm).

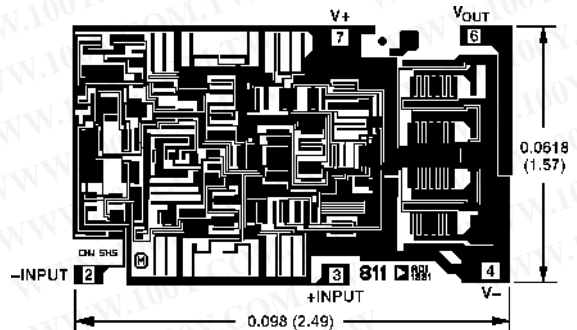

AD811—Typical Performance Characteristics

勝特力材料 886-3-5753170
 勝特力电子(上海) 86-21-54151736
 勝特力电子(深圳) 86-755-83298787
[Http://www.100y.com.tw](http://www.100y.com.tw)

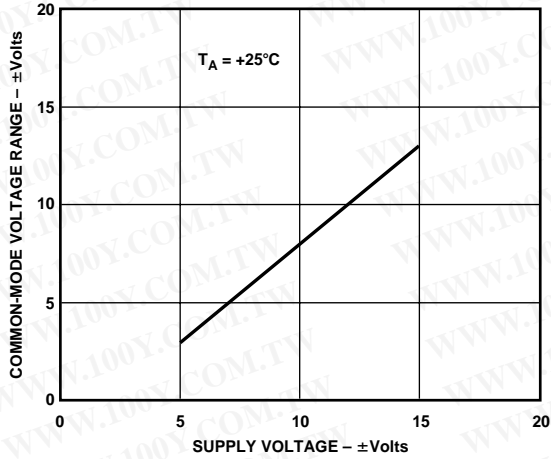

Figure 1. Input Common-Mode Voltage Range vs. Supply

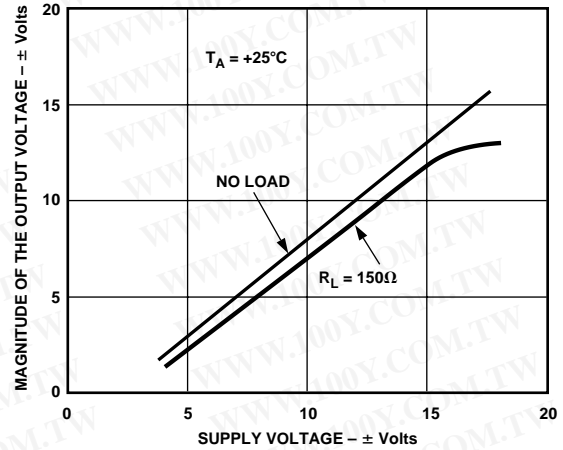

Figure 4. Output Voltage Swing vs. Supply

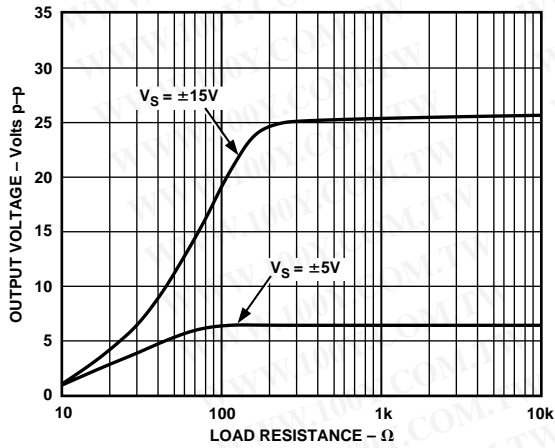

Figure 2. Output Voltage Swing vs. Resistive Load

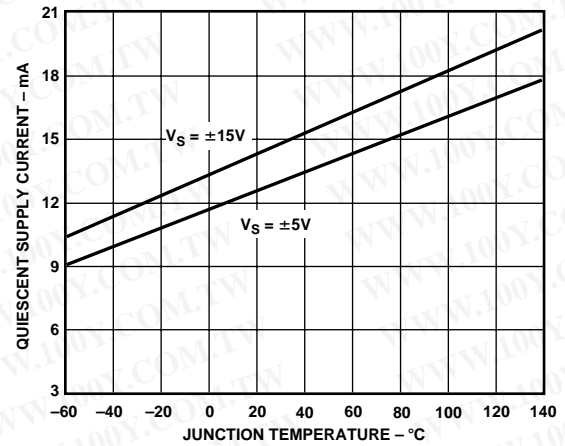

Figure 5. Quiescent Supply Current vs. Junction Temperature

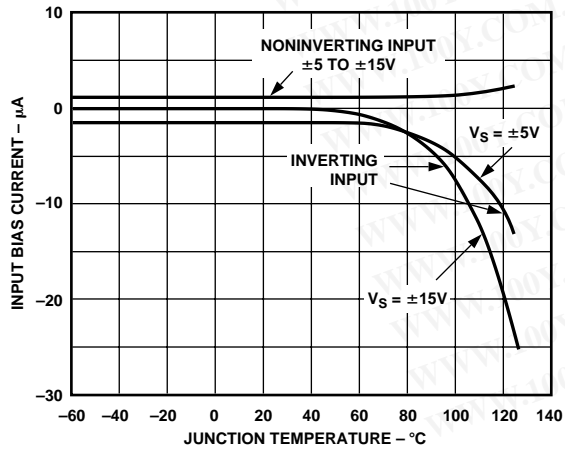

Figure 3. Input Bias Current vs. Junction Temperature

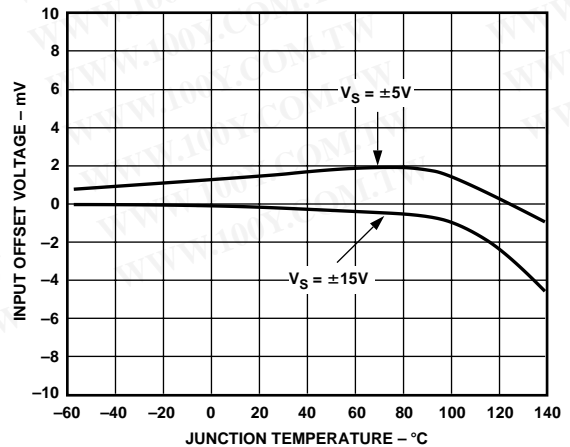

Figure 6. Input Offset Voltage vs. Junction Temperature

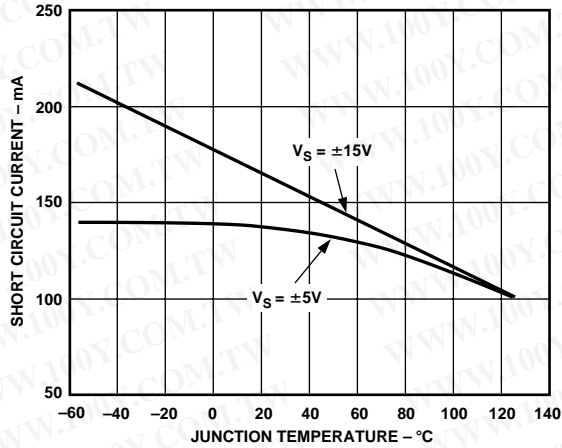

Figure 7. Short Circuit Current vs. Junction Temperature

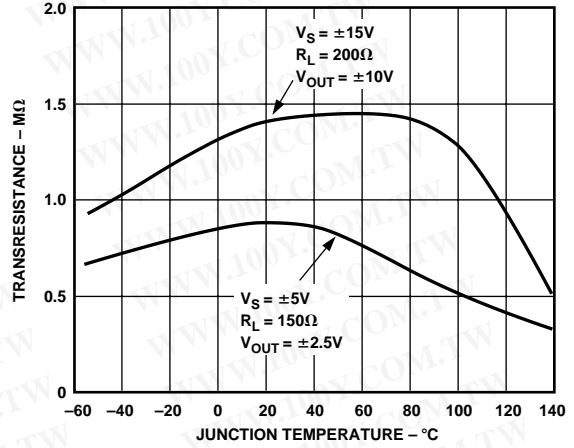

Figure 10. Transresistance vs. Junction Temperature

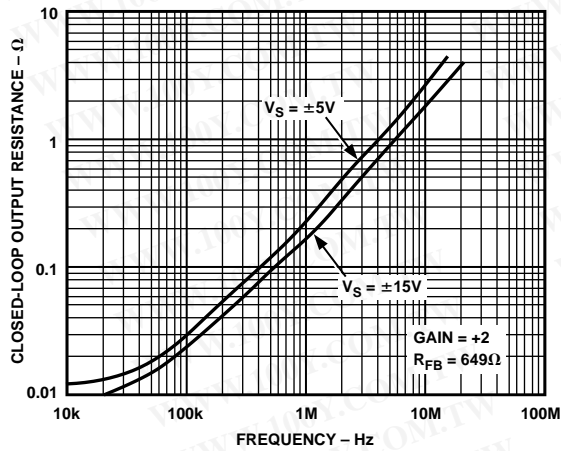

Figure 8. Closed-Loop Output Resistance vs. Frequency

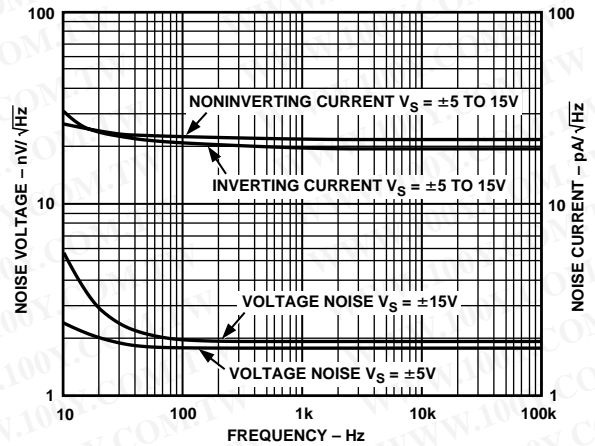

Figure 11. Input Noise vs. Frequency

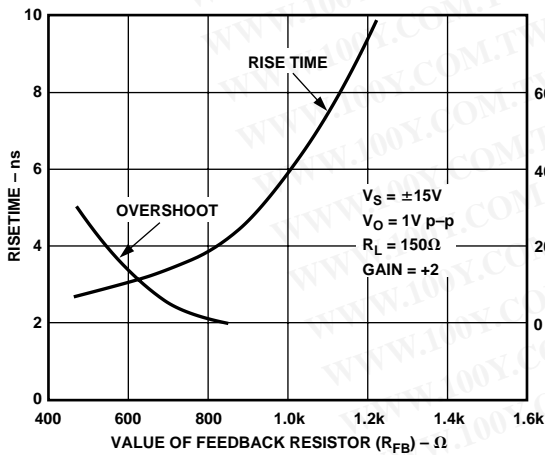

Figure 9. Rise Time and Overshoot vs. Value of Feedback Resistor, R_{FB}

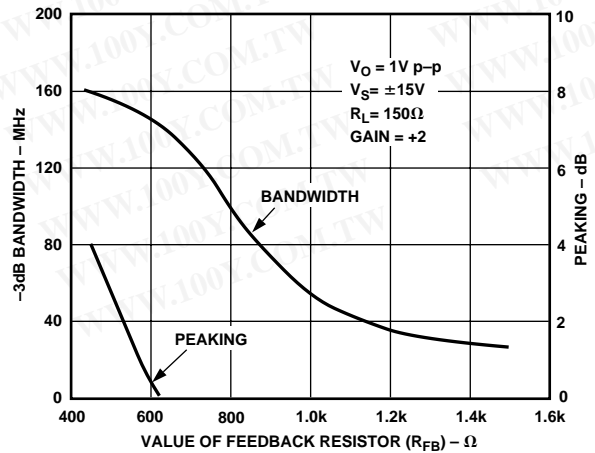

Figure 12. 3 dB Bandwidth and Peaking vs. Value of R_{FB}

AD811

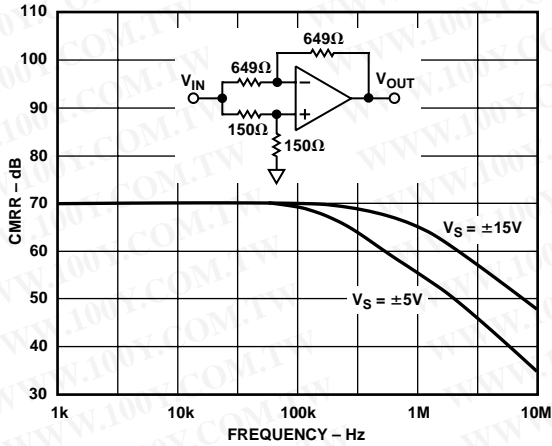

Figure 13. Common-Mode Rejection vs. Frequency

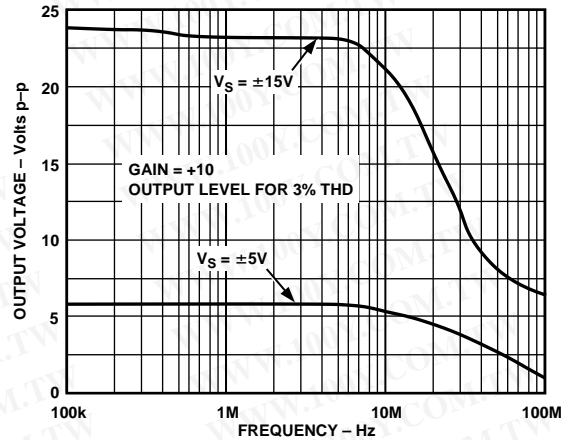

Figure 16. Large Signal Frequency Response

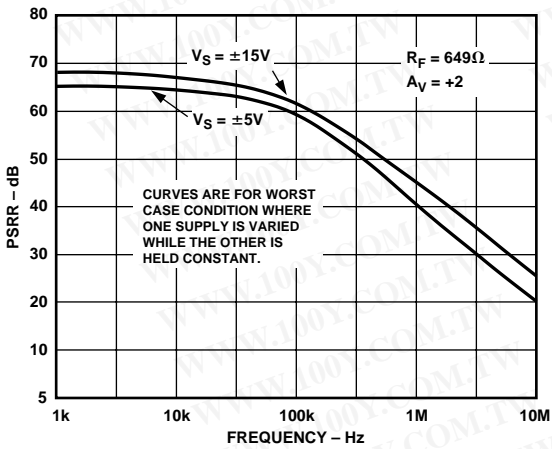

Figure 14. Power Supply Rejection vs. Frequency

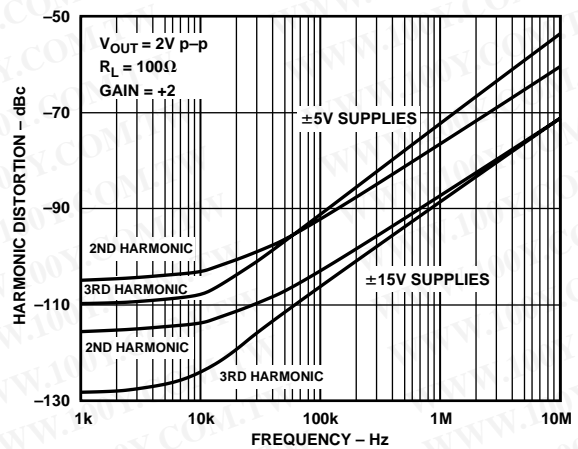

Figure 17. Harmonic Distortion vs. Frequency

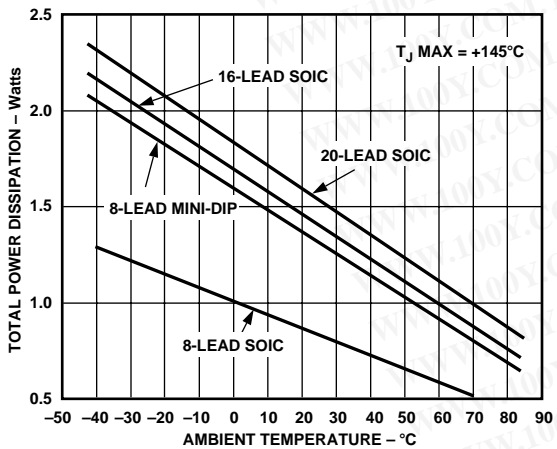

Figure 15. Maximum Power Dissipation vs. Temperature for Plastic Packages

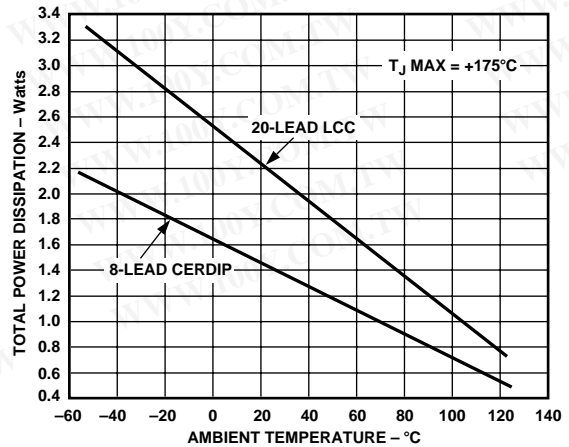

Figure 18. Maximum Power Dissipation vs. Temperature for Hermetic Packages

Typical Characteristics, Noninverting Connection-AD811

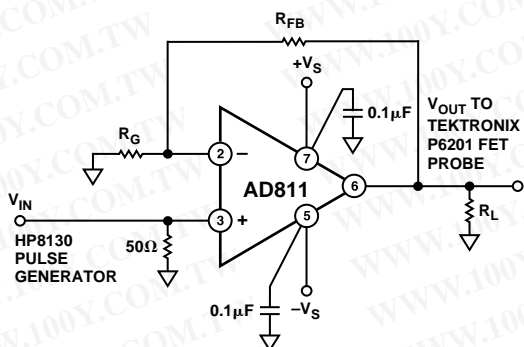

Figure 19. Noninverting Amplifier Connection

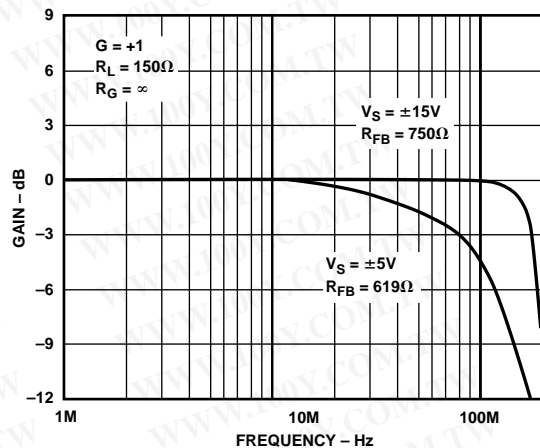

Figure 22. Closed-Loop Gain vs. Frequency, Gain = +1

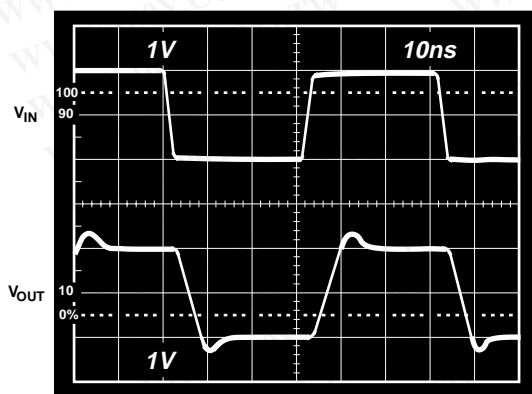

Figure 20. Small Signal Pulse Response, Gain = +1

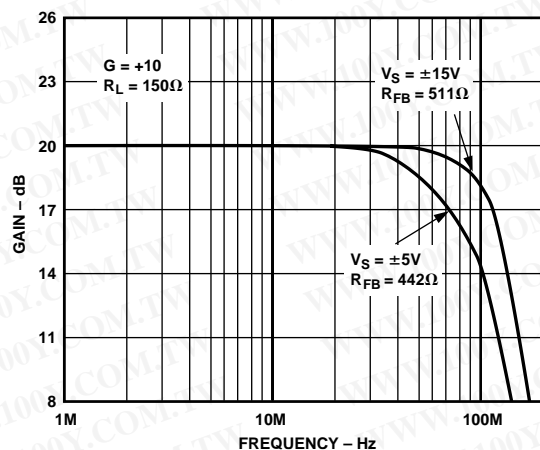

Figure 23. Closed-Loop Gain vs. Frequency, Gain = +10

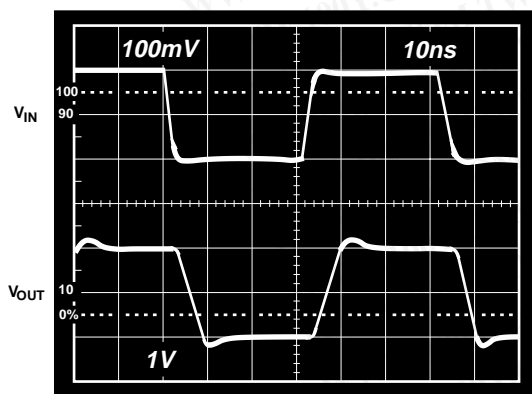

Figure 21. Small Signal Pulse Response, Gain = +10

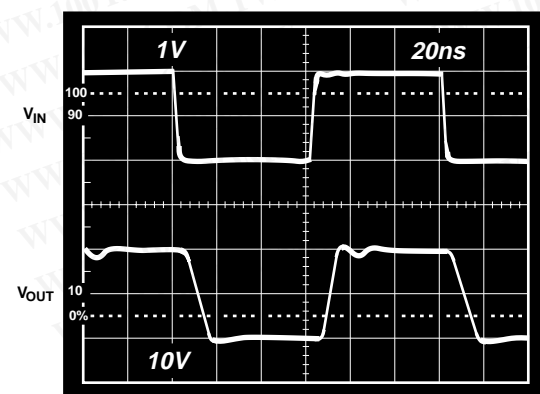

Figure 24. Large Signal Pulse Response, Gain = +10

AD811—Typical Characteristics, Inverting Connection

勝特力材料 886-3-5753170
 勝特力电子(上海) 86-21-54151736
 勝特力电子(深圳) 86-755-83298787
[Http://www.100y.com.tw](http://www.100y.com.tw)

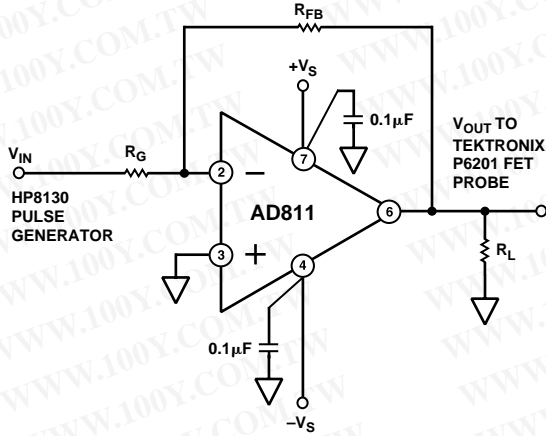

Figure 25. Inverting Amplifier Connection

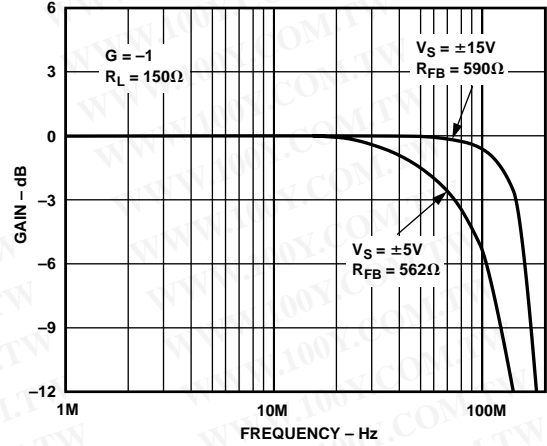

Figure 28. Closed-Loop Gain vs. Frequency, Gain = -1

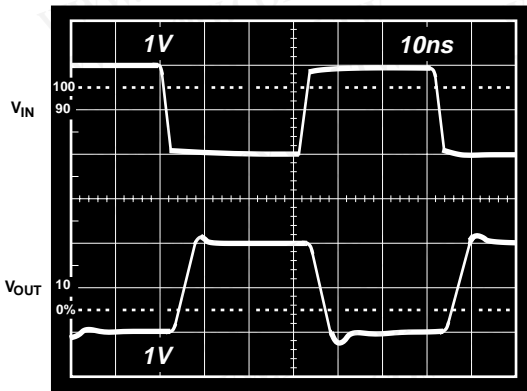

Figure 26. Small Signal Pulse Response, Gain = -1

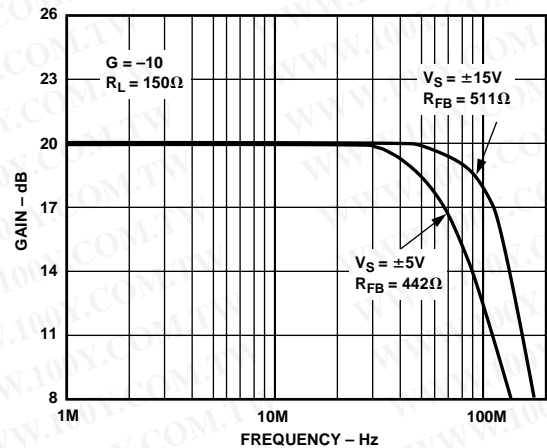

Figure 29. Closed-Loop Gain vs. Frequency, Gain = -10

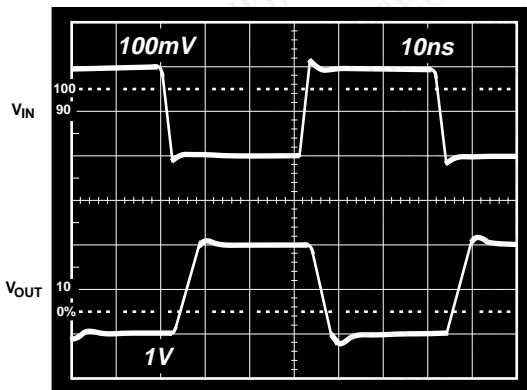

Figure 27. Small Signal Pulse Response, Gain = -10

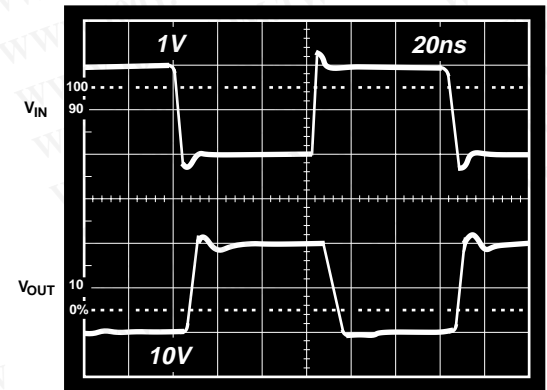

Figure 30. Large Signal Pulse Response, Gain = -10

APPLICATIONS

General Design Considerations

The AD811 is a current feedback amplifier optimized for use in high performance video and data acquisition applications. Since it uses a current feedback architecture, its closed-loop -3 dB bandwidth is dependent on the magnitude of the feedback resistor. The desired closed-loop gain and bandwidth are obtained by varying the feedback resistor (R_{FB}) to tune the bandwidth, and varying the gain resistor (R_G) to get the correct gain. Table I contains recommended resistor values for a variety of useful closed-loop gains and supply voltages.

Table I. -3 dB Bandwidth vs. Closed-Loop Gain and Resistance Values

$V_S = \pm 15$ V Closed-Loop Gain	R_{FB}	R_G	-3 dB BW (MHz)
+1	750 Ω		140
+2	649 Ω	649 Ω	120
+10	511 Ω	56.2 Ω	100
-1	590 Ω	590 Ω	115
-10	511 Ω	51.1 Ω	95
$V_S = \pm 5$ V Closed-Loop Gain	R_{FB}	R_G	-3 dB BW (MHz)
+1	619 Ω		80
+2	562 Ω	562 Ω	80
+10	442 Ω	48.7 Ω	65
-1	562 Ω	562 Ω	75
-10	442 Ω	44.2 Ω	65
$V_S = \pm 10$ V Closed-Loop Gain	R_{FB}	R_G	-3 dB BW (MHz)
+1	649 Ω		105
+2	590 Ω	590 Ω	105
+10	499 Ω	49.9 Ω	80
-1	590 Ω	590 Ω	105
-10	499 Ω	49.9 Ω	80

Figures 11 and 12 illustrate the relationship between the feedback resistor and the frequency and time domain response characteristics for a closed-loop gain of +2. (The response at other gains will be similar.)

The 3 dB bandwidth is somewhat dependent on the power supply voltage. As the supply voltage is decreased for example, the magnitude of internal junction capacitances is increased, causing a reduction in closed-loop bandwidth. To compensate for this, smaller values of feedback resistor are used at lower supply voltages.

Achieving the Flattest Gain Response at High Frequency

Achieving and maintaining gain flatness of better than 0.1 dB at frequencies above 10 MHz requires careful consideration of several issues.

Choice of Feedback and Gain Resistors

Because of the above-mentioned relationship between the 3 dB bandwidth and the feedback resistor, the fine scale gain flatness will, to some extent, vary with feedback resistor tolerance. It is, therefore, recommended that resistors with a 1% tolerance be used if it is desired to maintain flatness over a wide range of production lots. In addition, resistors of different construction have different associated parasitic capacitance and inductance. Metal-film resistors were used for the bulk of the characterization for this data sheet. It is possible that values other than those indicated will be optimal for other resistor types.

Printed Circuit Board Layout Considerations

As to be expected for a wideband amplifier, PC board parasitics can affect the overall closed loop performance. Of concern are stray capacitances at the output and the inverting input nodes. If a ground plane is to be used on the same side of the board as the signal traces, a space (3/16" is plenty) should be left around the signal lines to minimize coupling. Additionally, signal lines connecting the feedback and gain resistors should be short enough so that their associated inductance does not cause high frequency gain errors. Line lengths less than 1/4" are recommended.

Quality of Coaxial Cable

Optimum flatness when driving a coax cable is possible only when the driven cable is terminated at each end with a resistor matching its characteristic impedance. If the coax was ideal, then the resulting flatness would not be affected by the length of the cable. While outstanding results can be achieved using inexpensive cables, it should be noted that some variation in flatness due to varying cable lengths may be experienced.

Power Supply Bypassing

Adequate power supply bypassing can be critical when optimizing the performance of a high frequency circuit. Inductance in the power supply leads can form resonant circuits that produce peaking in the amplifier's response. In addition, if large current transients must be delivered to the load, then bypass capacitors (typically greater than 1 μ F) will be required to provide the best settling time and lowest distortion. Although the recommended 0.1 μ F power supply bypass capacitors will be sufficient in many applications, more elaborate bypassing (such as using two parallel capacitors) may be required in some cases.

AD811

Driving Capacitive Loads

The feedback and gain resistor values in Table I will result in very flat closed-loop responses in applications where the load capacitances are below 10 pF. Capacitances greater than this will result in increased peaking and overshoot, although not necessarily in a sustained oscillation.

There are at least two very effective ways to compensate for this effect. One way is to increase the magnitude of the feedback resistor, which lowers the 3 dB frequency. The other method is to include a small resistor in series with the output of the amplifier to isolate it from the load capacitance. The results of these two techniques are illustrated in Figure 32. Using a 1.5 kΩ feedback resistor, the output ripple is less than 0.5 dB when driving 100 pF. The main disadvantage of this method is that it sacrifices a little bit of gain flatness for increased capacitive load drive capability. With the second method, using a series resistor, the loss of flatness does not occur.

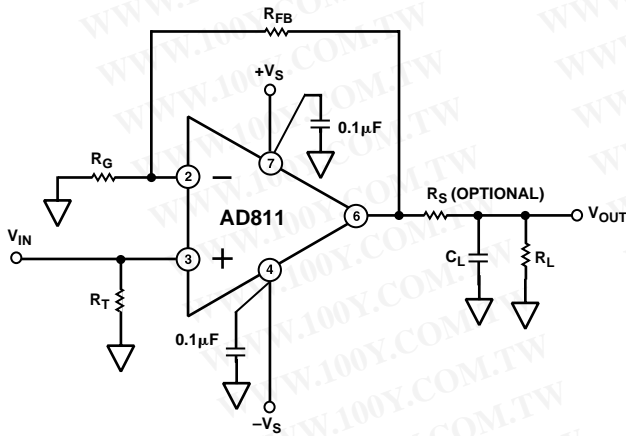

Figure 31. Recommended Connection for Driving a Large Capacitive Load

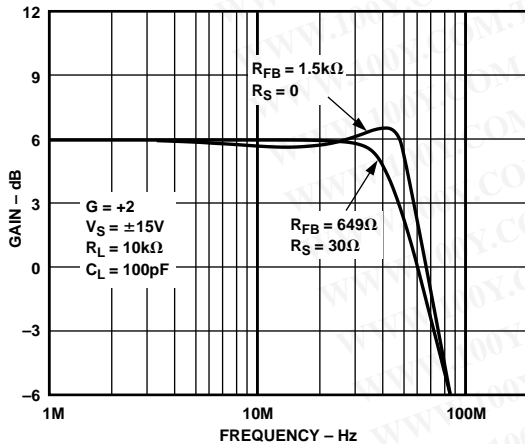

Figure 32. Performance Comparison of Two Methods for Driving a Capacitive Load

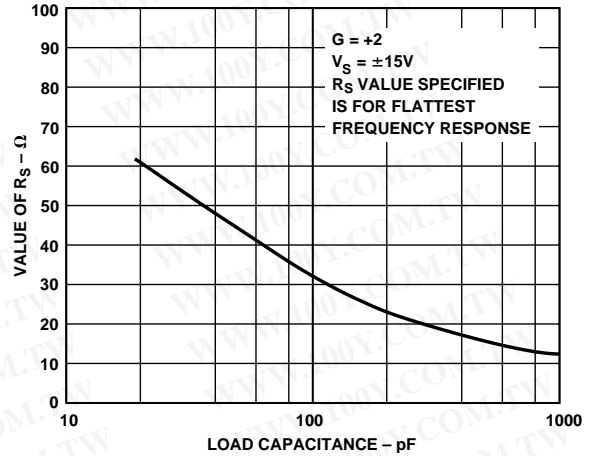

Figure 33. Recommended Value of Series Resistor vs. the Amount of Capacitive Load

Figure 33 shows recommended resistor values for different load capacitances. Refer again to Figure 32 for an example of the results of this method. Note that it may be necessary to adjust the gain setting resistor, R_G , to correct for the attenuation which results due to the divider formed by the series resistor, R_S , and the load resistance.

Applications which require driving a large load capacitance at a high slew rate are often limited by the output current available from the driving amplifier. For example, an amplifier limited to 25 mA output current cannot drive a 500 pF load at a slew rate greater than 50 V/μs. However, because of the AD811's 100 mA output current, a slew rate of 200 V/μs is achievable when driving this same 500 pF capacitor (see Figure 34).

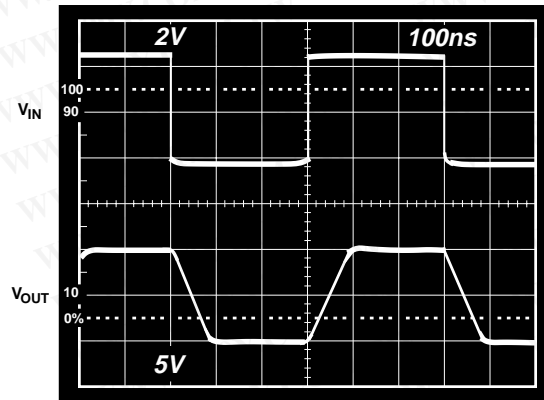

Figure 34. Output Waveform of an AD811 Driving a 500 pF Load. Gain = +2, $R_{FB} = 649 \Omega$, $R_S = 15 \Omega$, $R_L = 10 k\Omega$

Operation as a Video Line Driver

The AD811 has been designed to offer outstanding performance at closed-loop gains of one or greater, while driving multiple reverse-terminated video loads. The lowest differential gain and phase errors will be obtained when using ± 15 volt power supplies. With ± 12 volt supplies, there will be an insignificant increase in these errors and a slight improvement in gain flatness. Due to power dissipation considerations, ± 12 volt supplies are recommended for optimum video performance. Excellent performance can be achieved at much lower supplies as well.

The closed-loop gain vs. frequency at different supply voltages is shown in Figure 36. Figure 37 is an oscilloscope photograph of an AD811 line driver's pulse response with ± 15 volt supplies. The differential gain and phase error vs. supply are plotted in Figures 38 and 39, respectively.

Another important consideration when driving multiple cables is the high frequency isolation between the outputs of the cables. Due to its low output impedance, the AD811 achieves better than 40 dB of output to output isolation at 5 MHz driving back terminated 75 Ω cables.

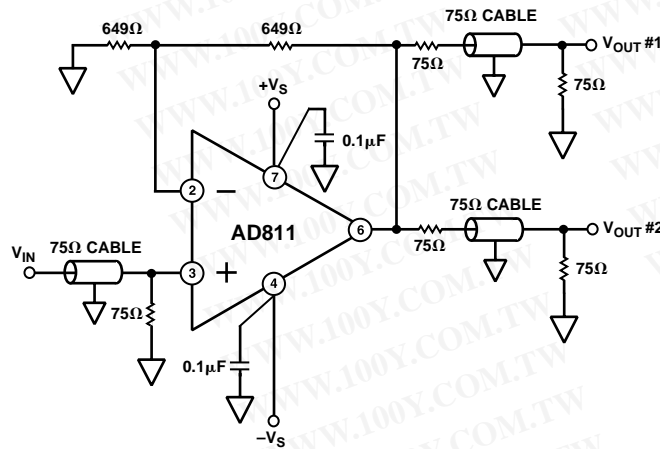

Figure 35. A Video Line Driver Operating at a Gain of +2

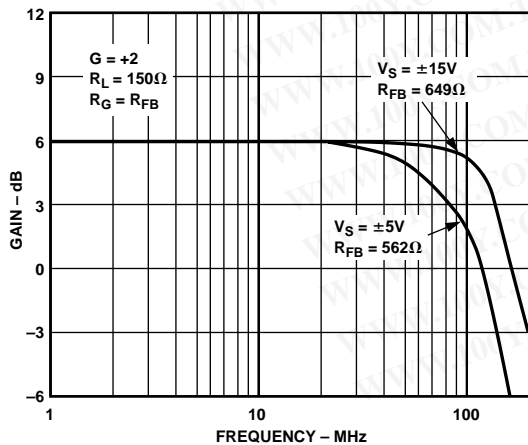

Figure 36. Closed-Loop Gain vs. Frequency, Gain = +2

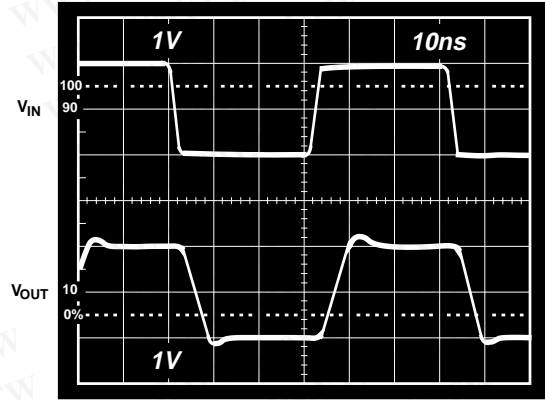

Figure 37. Small Signal Pulse Response, Gain = +2, $V_S = \pm 15$ V

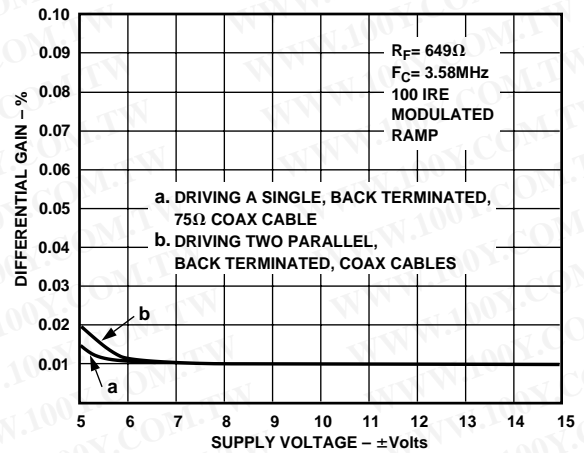

Figure 38. Differential Gain Error vs. Supply Voltage for the Video Line Driver of Figure 35

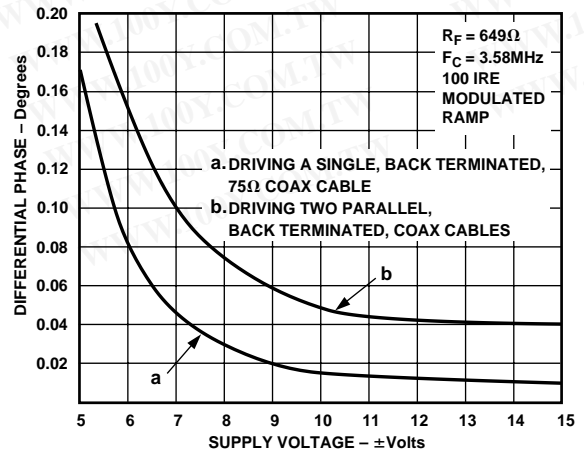

Figure 39. Differential Phase Error vs. Supply Voltage for the Video Line Driver of Figure 35

AD811

勝特力材料 886-3-5753170
 勝特力电子(上海) 86-21-54151736
 勝特力电子(深圳) 86-755-83298787
[Http://www.100y.com.tw](http://www.100y.com.tw)

An 80 MHz Voltage-Controlled Amplifier Circuit

The voltage-controlled amplifier (VCA) circuit of Figure 40 shows the AD811 being used with the AD834, a 500 MHz, 4-quadrant multiplier. The AD834 multiplies the signal input by the dc control voltage, V_G . The AD834 outputs are in the form of differential currents from a pair of open collectors, ensuring that the full bandwidth of the multiplier (which exceeds 500 MHz) is available for certain applications. Here, the AD811 op amp provides a buffered, single-ended ground-referenced output. Using feedback resistors R8 and R9 of 511 Ω , the overall gain ranges from -70 dB, for $V_G = 0$ dB to +12 dB, (a numerical gain of four), when $V_G = +1$ V. The overall transfer function of the VCA is:

$$V_{OUT} = 4 (X1 - X2)(Y1 - Y2)$$

which reduces to $V_{OUT} = 4 V_G V_{IN}$ using the labeling conventions shown in Figure 40. The circuit's -3 dB bandwidth of 80 MHz, is maintained essentially constant—independent of gain. The response can be maintained flat to within ± 0.1 dB from dc to 40 MHz at full gain with the addition of an optional capacitor of about 0.3 pF across the feedback resistor R8. The circuit produces a full-scale output of ± 4 V for a ± 1 V input, and can drive a reverse-terminated load of 50 Ω or 75 Ω to ± 2 V.

The gain can be increased to 20 dB ($\times 10$) by raising R8 and R9 to 1.27 k Ω , with a corresponding decrease in -3 dB bandwidth to about 25 MHz. The maximum output voltage under these conditions will be increased to ± 9 V using ± 12 V supplies.

The gain-control input voltage, V_G , may be a positive or negative ground-referenced voltage, or fully differential, depending on the user's choice of connections at Pins 7 and 8. A positive value of V_G results in an overall noninverting response. Reversing the sign of V_G simply causes the sign of the overall response to invert. In fact, although this circuit has been classified as a voltage-controlled amplifier, it is also quite useful as a general-purpose four-quadrant multiplier, with good load-driving capabilities and fully-symmetrical responses from X- and Y-inputs.

The AD811 and AD834 can both be operated from power supply voltages of ± 5 V. While it is not necessary to power them from the same supplies, the common-mode voltage at W1 and W2 must be biased within the common-mode range of the AD811's input stage. To achieve the lowest differential gain and phase errors, it is recommended that the AD811 be operated from power supply voltages of ± 10 volts or greater. This VCA circuit is designed to operate from a ± 12 volt dual power supply.

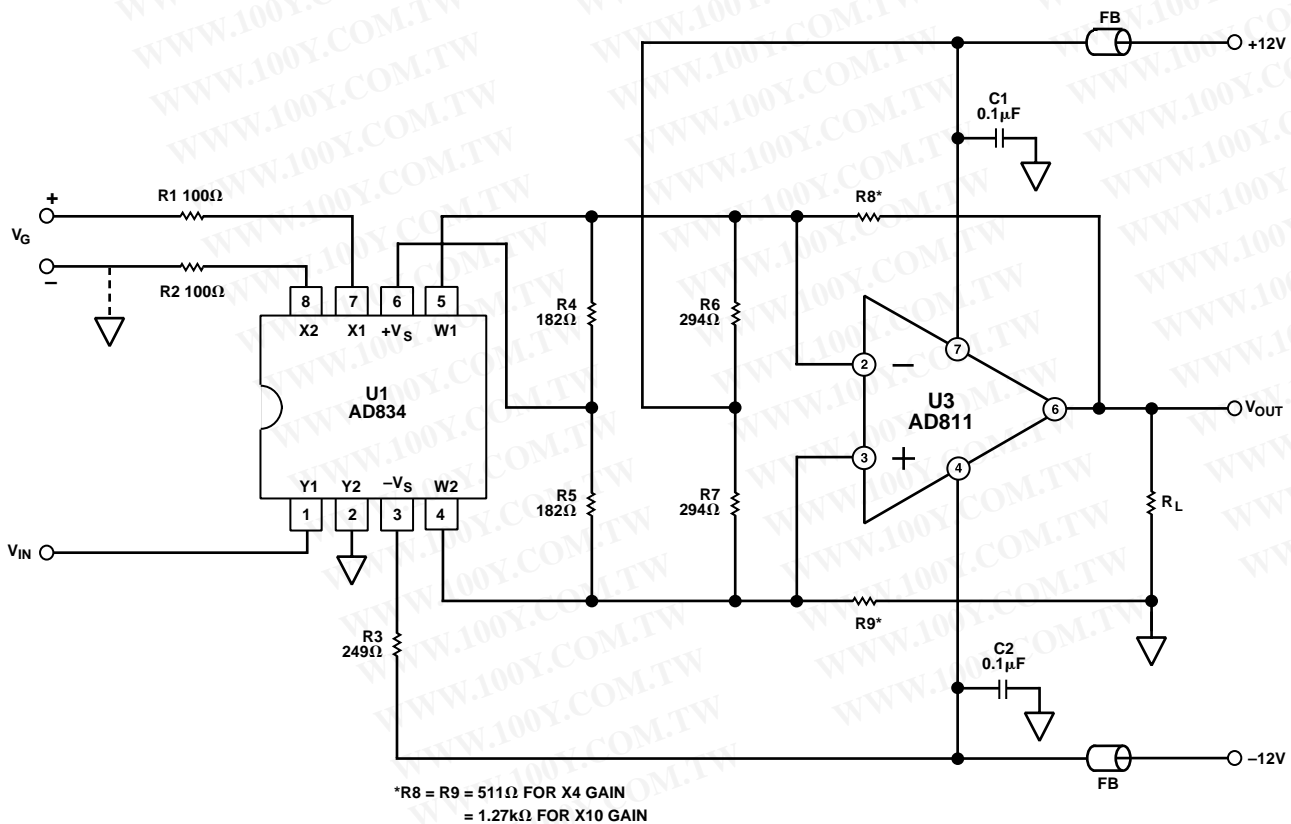

Figure 40. An 80 MHz Voltage-Controlled Amplifier

A Video Keyer Circuit

By using two AD834 multipliers, an AD811, and a 1 V dc source, a special form of a two-input VCA circuit called a video keyer can be assembled. "Keying" is the term used in reference to blending two or more video sources under the control of a third signal or signals to create such special effects as dissolves and overlays. The circuit shown in Figure 41 is a two-input keyer, with video inputs V_A and V_B , and a control input V_G . The transfer function (with V_{OUT} at the load) is given by:

$$V_{OUT} = G V_A + (1-G) V_B$$

where G is a dimensionless variable (actually, just the gain of the "A" signal path) that ranges from 0 when $V_G = 0$, to 1 when $V_G = +1$ V. Thus, V_{OUT} varies continuously between V_A and V_B as G varies from 0 to 1.

Circuit operation is straightforward. Consider first the signal path through $U1$, which handles video input V_A . Its gain is clearly zero when $V_G = 0$ and the scaling we have chosen ensures that it is unity when $V_G = +1$ V; this takes care of the first term of the transfer function. On the other hand, the V_G input to $U2$ is taken to the inverting input $X2$ while $X1$ is biased at an accurate +1 V. Thus, when $V_G = 0$, the response to video input V_B is already at its full-scale value of unity, whereas when $V_G = +1$ V, the differential input $X1-X2$ is zero. This generates the second term.

The bias currents required at the output of the multipliers are provided by $R8$ and $R9$. A dc-level-shifting network comprising $R10/R12$ and $R11/R13$ ensures that the input nodes of the AD811 are positioned at a voltage within its common-mode range. At high frequencies $C1$ and $C2$ bypass $R10$ and $R11$ respectively. $R14$ is included to lower the HF loop gain, and is needed because the voltage-to-current conversion in the AD834s, via the $Y2$ inputs, results in an effective value of the feedback resistance of 250Ω ; this is only about half the value required for optimum flatness in the AD811's response. (Note that this resistance is unaffected by G : when $G = 1$, all the feedback is via $U1$, while when $G = 0$ it is all via $U2$). $R14$ reduces the fractional amount of output current from the multipliers into the current-summing inverting input of the AD811, by sharing it with $R8$. This resistor can be used to adjust the bandwidth and damping factor to best suit the application.

To generate the 1 V dc needed for the "1-G" term an AD589 reference supplies $1.225 \text{ V} \pm 25 \text{ mV}$ to a voltage divider consisting of resistors $R2$ through $R4$. Potentiometer $R3$ should be adjusted to provide exactly +1 V at the $X1$ input.

In this case, we have shown an arrangement using dual supplies of ± 5 V for both the AD834 and the AD811. Also, the overall gain in this case is arranged to be unity at the load, when it is driven from a reverse-terminated 75Ω line. This means that the "dual VCA" has to operate at a maximum gain of 2, rather

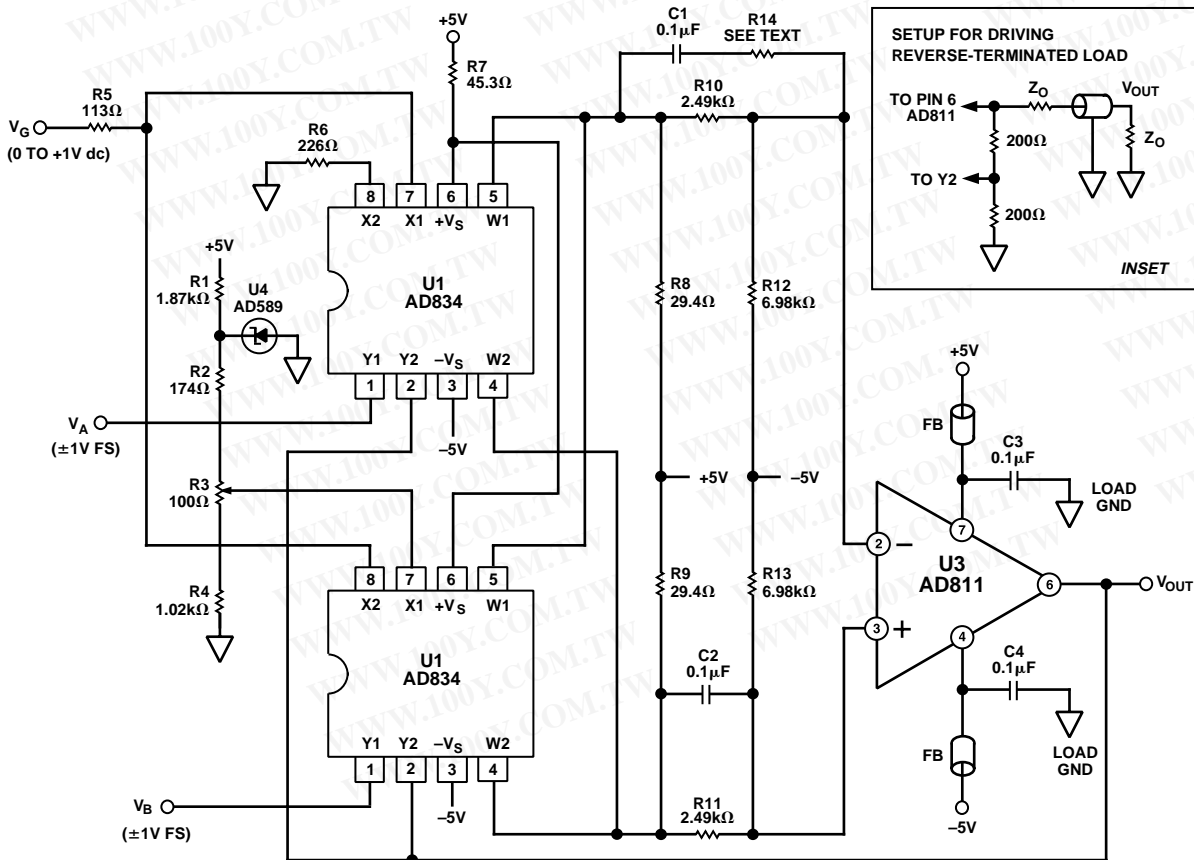

Figure 41. A Practical Video Keyer Circuit

AD811

than 4 as in the VCA circuit of Figure 40. However, this cannot be achieved by lowering the feedback resistor, since below a critical value (not much less than 500 Ω) the AD811's peaking may be unacceptable. This is because the dominant pole in the open-loop ac response of a current-feedback amplifier is controlled by this feedback resistor. It would be possible to operate at a gain of X4 and then attenuate the signal at the output. Instead, we have chosen to attenuate the signals by 6 dB at the input to the AD811; this is the function of R8 through R11.

Figure 42 is a plot of the ac response of the feedback keyer, when driving a reverse terminated 50 Ω cable. Output noise and adjacent channel feedthrough, with either channel fully off and the other fully on, is about -50 dB to 10 MHz. The feedthrough at 100 MHz is limited primarily by board layout. For $V_G = +1$ V, the -3 dB bandwidth is 15 MHz when using a 137 Ω resistor for R14 and 70 MHz with R14 = 49.9 Ω . For further information regarding the design and operation of the VCA and video keyer circuits, refer to the application note "Video VCA's and Keyers Using the AD834 & AD811" by Brunner, Clarke, and Gilbert, available FREE from Analog Devices.

勝特力材料 886-3-5753170
勝特力电子(上海) 86-21-54151736
勝特力电子(深圳) 86-755-83298787
[Http://www.100y.com.tw](http://www.100y.com.tw)

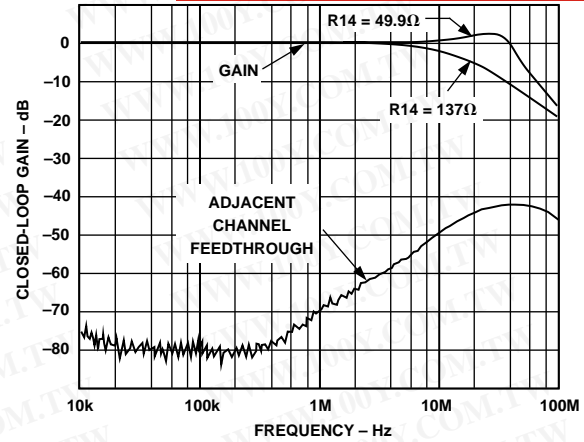

Figure 42. A Plot of the AC Response of the Video Keyer

