

DATA SHEET

勝特力材料 886-3-5753170
勝特力电子(上海) 86-21-54151736
勝特力电子(深圳) 86-755-83298787
[Http://www.100y.com.tw](http://www.100y.com.tw)

74LVC16245A; 74LVCH16245A 16-bit bus transceiver with direction pin; 5 V tolerant; 3-state

Product specification
Supersedes data of 2003 Jan 30

2003 Nov 25

16-bit bus transceiver with direction pin; 5 V tolerant; 3-state

74LVC16245A; 74LVCH16245A

FEATURES

- 5 V tolerant inputs/outputs for interfacing with 5 V logic
- Wide supply voltage range from 1.2 to 3.6 V
- CMOS low power consumption
- MULTIBYTE™ flow-through standard pin-out architecture
- Low inductance multiple power and ground pins for minimum noise and ground bounce
- Direct interface with TTL levels
- High-impedance when $V_{CC} = 0$ V
- All data inputs have bushold (74LVCH16245A only)
- Complies with JEDEC standard no. 8-1A
- ESD protection:
HBM EIA/JESD22-A114-A exceeds 2000 V
MM EIA/JESD22-A115-A exceeds 200 V.

DESCRIPTION

The 74LVC(H)16245A is a high-performance, low-power, low-voltage, Si-gate CMOS device, superior to most advanced CMOS compatible TTL families. Inputs can be driven from either 3.3 or 5 V devices. In 3-state operation, outputs can handle 5 Volt. These features allow the use of these devices as a mixed 3.3 and 5 V environment.

The 74LVC(H)16245A is a 16-bit transceiver featuring non-inverting 3-state bus compatible outputs in both send and receive directions. The device features two output enable ($n\overline{OE}$) inputs for easy cascading and two send/receive ($n\overline{DIR}$) inputs for direction control. $n\overline{OE}$ controls the outputs so that the buses are effectively isolated. This device can be used as two 8-bit transceivers or one 16-bit transceiver.

The 74LVCH16245A bushold data inputs eliminates the need for external pull-up resistors to hold unused inputs.

QUICK REFERENCE DATA

GND = 0 V; $T_{amb} = 25$ °C; $t_r = t_f \leq 2.5$ ns.

SYMBOL	PARAMETER	CONDITIONS	TYPICAL	UNIT
t_{PHL}/t_{PLH}	propagation delay nAn to nBn; nBn to nAn	$C_L = 50$ pF; $V_{CC} = 3.3$ V	2.2	ns
C_I	input capacitance		5.0	pF
$C_{I/O}$	input/output capacitance		10	pF
C_{PD}	power dissipation capacitance per gate	$V_{CC} = 3.3$ V; notes 1 and 2	30	pF

Notes

1. C_{PD} is used to determine the dynamic power dissipation (P_D in μ W).

$$P_D = C_{PD} \times V_{CC}^2 \times f_i \times N + \Sigma(C_L \times V_{CC}^2 \times f_o) \text{ where:}$$

f_i = input frequency in MHz;

f_o = output frequency in MHz;

C_L = output load capacitance in pF;

V_{CC} = supply voltage in Volts;

N = total load switching outputs;

$\Sigma(C_L \times V_{CC}^2 \times f_o)$ = sum of the outputs.

2. The condition is $V_I = \text{GND to } V_{CC}$.

勝特力材料 886-3-5753170
 勝特力电子(上海) 86-21-54151736
 勝特力电子(深圳) 86-755-83298787
[Http://www.100y.com.tw](http://www.100y.com.tw)

16-bit bus transceiver with direction pin; 5 V tolerant;
3-state

74LVC16245A;
74LVCH16245A

ORDERING INFORMATION

TYPE NUMBER	PACKAGE				
	TEMPERATURE RANGE	PINS	PACKAGE	MATERIAL	CODE
74LVC16245ADL	-40 to +125 °C	48	SSOP48	plastic	SOT370-1
74LVCH16245ADL	-40 to +125 °C	48	SSOP48	plastic	SOT370-1
74LVC16245ADGG	-40 to +125 °C	48	TSSOP48	plastic	SOT362-1
74LVCH16245ADGG	-40 to +125 °C	48	TSSOP48	plastic	SOT362-1
74LVC16245AEV	-40 to +125 °C	56	VFBGA56	plastic	SOT702-1
74LVCH16245AEV	-40 to +125 °C	56	VFBGA56	plastic	SOT702-1

FUNCTION TABLE

See note 1.

INPUT		OUTPUT	
nOE	nDIR	nAn	nBn
L	L	A = B	inputs
L	H	inputs	B = A
H	X	Z	Z

Note

- H = HIGH voltage level;
L = LOW voltage level;
X = don't care;
Z = high-impedance OFF-state.

勝特力材料 886-3-5753170
勝特力电子(上海) 86-21-54151736
勝特力电子(深圳) 86-755-83298787
[Http://www.100y.com.tw](http://www.100y.com.tw)

16-bit bus transceiver with direction pin; 5 V tolerant;
 3-state

74LVC16245A;
 74LVCH16245A

PINNING

SYMBOL	PIN	BALL	DESCRIPTION
1DIR	1	A1	direction control input
1B0	2	B2	data input/output
1B1	3	B1	data input/output
GND	4, 10, 15, 21, 28, 34, 39, 45	B3, B4, D3, D4, G3, G4, J3, J4	ground (0 V)
1B2	5	C2	data input/output
1B3	6	C1	data input/output
V _{CC}	7, 18, 31, 42	C3, C4, H3, H4	supply voltage
1B4	8	D2	data input/output
1B5	9	D1	data input/output
1B6	11	E2	data input/output
1B7	12	E1	data input/output
2B0	13	F1	data input/output
2B1	14	F2	data input/output
2B2	16	G1	data input/output
2B3	17	G2	data input/output
2B4	19	H1	data input/output
2B5	20	H2	data input/output
2B6	22	J1	data input/output
2B7	23	J2	data input/output
2DIR	24	K1	direction control input
2OE	25	K6	output enable input (active LOW)
2A7	26	J5	data input/output
2A6	27	J6	data input/output
2A5	29	H5	data input/output
2A4	30	H6	data input/output
2A3	32	G5	data input/output
2A2	33	G6	data input/output
2A1	35	F5	data input/output
2A0	36	F6	data input/output
1A7	37	E6	data input/output
1A6	38	E5	data input/output
1A5	40	D6	data input/output
1A4	41	D5	data input/output
1A3	43	C6	data input/output
1A2	44	C5	data input/output
1A1	46	B6	data input/output
1A0	47	B5	data input/output
1OE	48	A6	output enable input (active LOW)
n.c.	–	A2, A3, A4, A5, K2, K3, K4, K5	not connected

16-bit bus transceiver with direction pin; 5 V tolerant;
3-state

74LVC16245A;
74LVCH16245A

勝特力材料 886-3-5753170
 勝特力电子(上海) 86-21-54151736
 勝特力电子(深圳) 86-755-83298787
[Http://www.100y.com.tw](http://www.100y.com.tw)

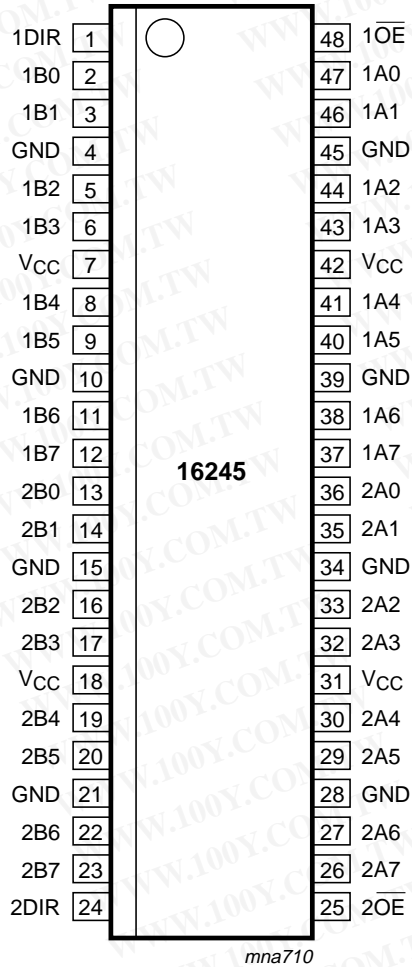

Fig.1 Pin configuration SSOP48 and TSSOP48.

A	1DIR	n.c.	n.c.	n.c.	n.c.	1OE
B	1B1	1B0	GND	GND	1A0	1A1
C	1B3	1B2	Vcc	Vcc	1A2	1A3
D	1B5	1B4	GND	GND	1A4	1A5
E	1B7	1B6			1A6	1A7
F	2B0	2B1			2A1	2A0
G	2B2	2B3	GND	GND	2A3	2A2
H	2B4	2B5	Vcc	Vcc	2A5	2A4
J	2B6	2B7	GND	GND	2A7	2A6
K	2DIR	n.c.	n.c.	n.c.	n.c.	2OE
	1	2	3	4	5	6

mna707

Fig.2 Pin configuration VFBGA56.

16-bit bus transceiver with direction pin; 5 V tolerant;
3-state

74LVC16245A;
74LVCH16245A

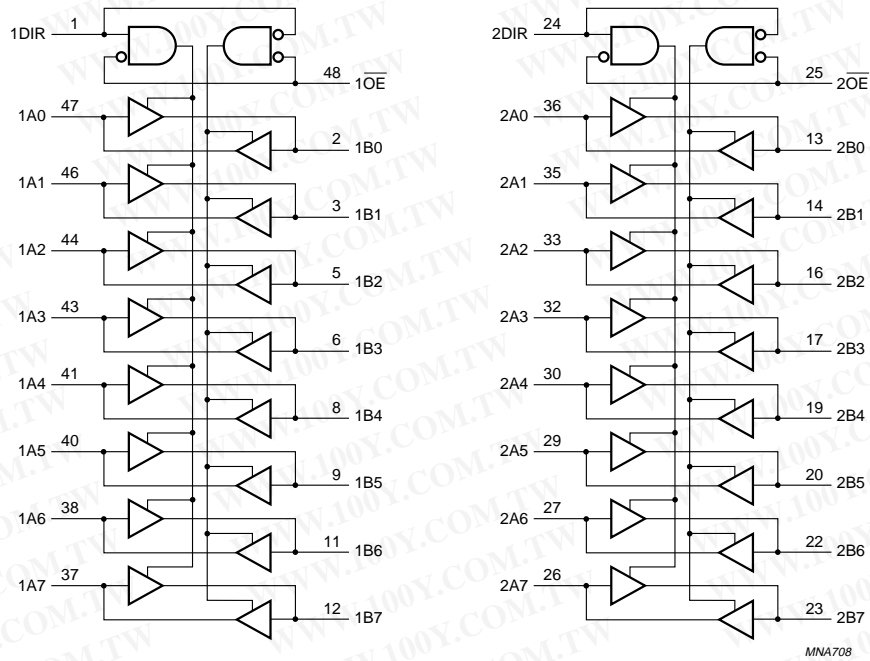
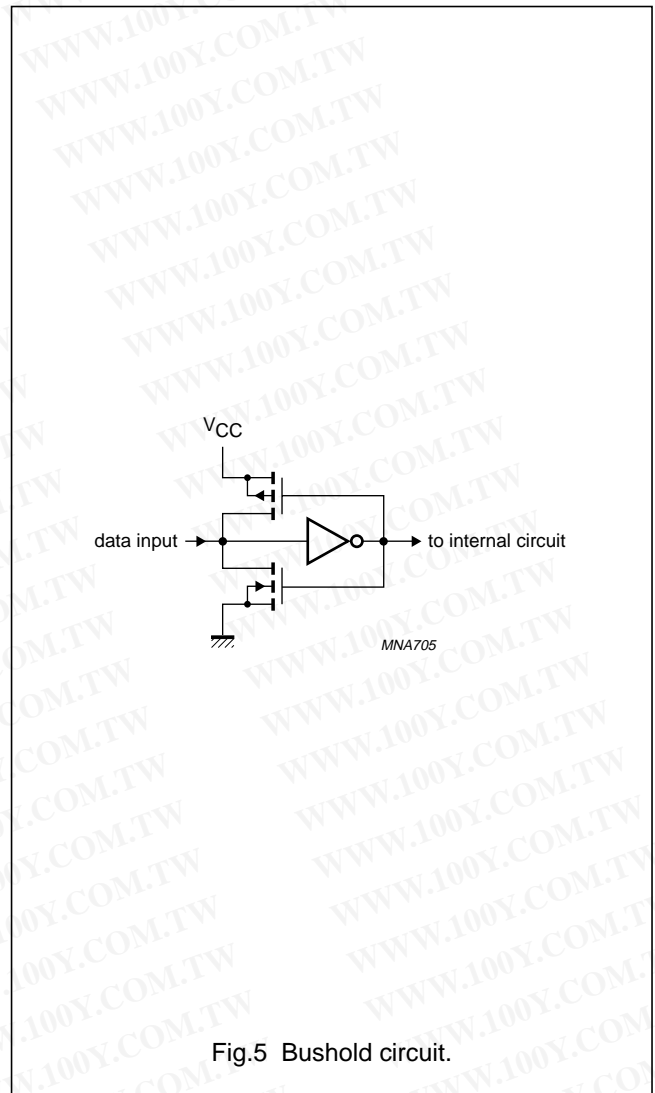
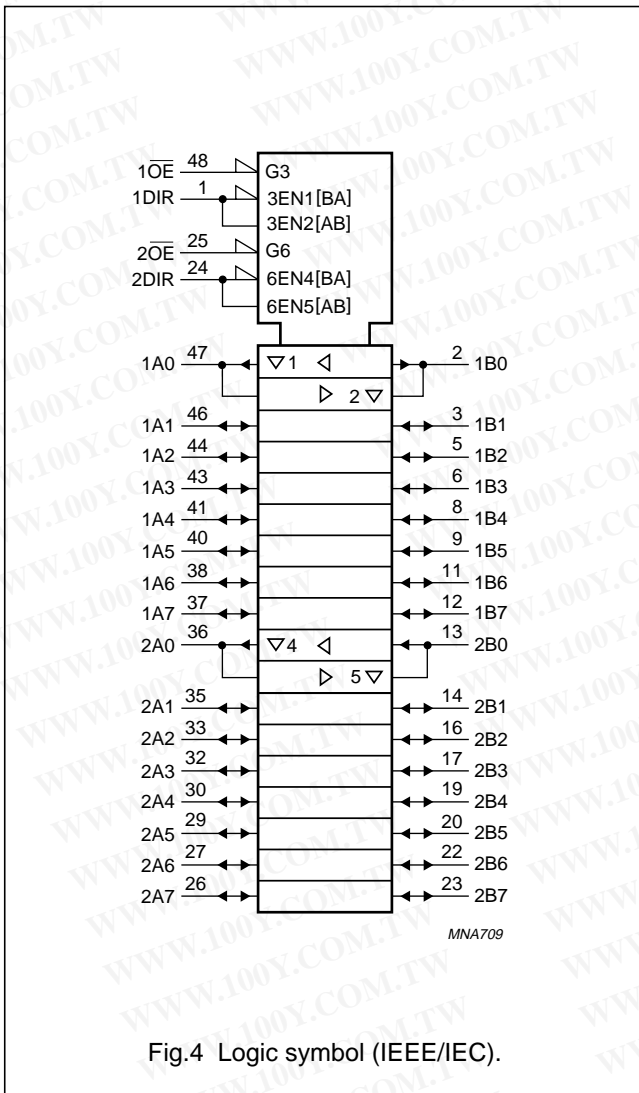

Fig.3 Logic symbol.

勝特力材料 886-3-5753170
勝特力电子(上海) 86-21-54151736
勝特力电子(深圳) 86-755-83298787
[Http://www.100y.com.tw](http://www.100y.com.tw)

16-bit bus transceiver with direction pin; 5 V tolerant;
3-state

74LVC16245A;
74LVCH16245A



勝特力材料 886-3-5753170
 胜特力电子(上海) 86-21-54151736
 胜特力电子(深圳) 86-755-83298787
[Http://www.100y.com.tw](http://www.100y.com.tw)

16-bit bus transceiver with direction pin; 5 V tolerant;
3-state

74LVC16245A;
74LVCH16245A

RECOMMENDED OPERATING CONDITIONS

SYMBOL	PARAMETER	CONDITIONS	MIN.	MAX.	UNIT
V _{CC}	supply voltage	for maximum speed performance	2.7	3.6	V
		for low voltage applications	1.2	3.6	V
V _I	input voltage		0	5.5	V
V _O	output voltage	output HIGH or LOW state	0	V _{CC}	V
		output 3-state	0	5.5	V
T _{amb}	operating ambient temperature	in free air	-40	+125	°C
t _r , t _f	input rise and fall times	V _{CC} = 1.2 to 2.7 V	0	20	ns/V
		V _{CC} = 2.7 to 3.6 V	0	10	ns/V

LIMITING VALUES

In accordance with the Absolute Maximum Rating System (IEC 60134); voltages are referenced to GND (ground = 0 V).

SYMBOL	PARAMETER	CONDITIONS	MIN.	MAX.	UNIT
V _{CC}	supply voltage		-0.5	+6.5	V
I _{IK}	input diode current	V _I < 0	-	-50	mA
V _I	input voltage	note 1	-0.5	+6.5	V
I _{OK}	output diode current	V _O > V _{CC} or V _O < 0	-	±50	mA
V _O	output voltage	output HIGH or LOW state; note 1	-0.5	V _{CC} + 0.5	V
		output 3-state; note 1	-0.5	+6.5	V
I _O	output source or sink current	V _O = 0 to V _{CC}	-	±50	mA
I _{CC} , I _{GND}	V _{CC} or GND current		-	±100	mA
T _{stg}	storage temperature		-65	+150	°C
P _{tot}	power dissipation SSOP and TSSOP package VFBGA package	T _{amb} = -40 to +125 °C; note 2	-	500	mW
		T _{amb} = -40 to +125 °C; note 3	-	1000	mW

Notes

- The input and output voltage ratings may be exceeded if the input and output current ratings are observed.
- Above 60 °C the value of P_D derates linearly with 5.5 mW/K.
- Above 70 °C the value of P_D derates linearly with 1.8 mW/K.

勝特力材料 886-3-5753170
 勝特力电子(上海) 86-21-54151736
 勝特力电子(深圳) 86-755-83298787
[Http://www.100y.com.tw](http://www.100y.com.tw)

**16-bit bus transceiver with direction pin; 5 V tolerant;
3-state**
**74LVC16245A;
74LVCH16245A**
DC CHARACTERISTICS

At recommended operating conditions; voltages are referenced to GND (ground = 0 V).

SYMBOL	PARAMETER	TEST CONDITIONS		MIN.	TYP. ⁽¹⁾	MAX.	UNIT
		OTHER	V _{CC} (V)				
T_{amb} = -40 to +85 °C							
V _{IH}	HIGH-level input voltage		1.2	V _{CC}	–	–	V
			2.7 to 3.6	2.0	–	–	V
V _{IL}	LOW-level input voltage		1.2	–	–	0	V
			2.7 to 3.6	–	–	0.8	V
V _{OH}	HIGH-level output voltage	V _I = V _{IH} or V _{IL} I _O = -100 μA	2.7 to 3.6	V _{CC} - 0.2	V _{CC}	–	V
		I _O = -12 mA	2.7	V _{CC} - 0.5	–	–	V
		I _O = -18 mA	3.0	V _{CC} - 0.6	–	–	V
		I _O = -24 mA	3.0	V _{CC} - 0.8	–	–	V
V _{OL}	LOW-level output voltage	V _I = V _{IH} or V _{IL} I _O = 100 μA	2.7 to 3.6	–	0	0.20	V
		I _O = 12 mA	2.7	–	–	0.40	V
		I _O = 24 mA	3.0	–	–	0.55	V
I _{LI}	input leakage current	V _I = 5.5 V or GND ; notes 2 and 3	3.6	–	±0.1	±5	μA
I _{OZ}	3-state output OFF-state current	V _I = V _{IH} or V _{IL} ; V _O = 5.5 V or GND	3.6	–	0.1	±5	μA
I _{off}	power off leakage supply	V _I or V _O = 5.5 V	0.0	–	0.1	±10	μA
I _{CC}	quiescent supply current	V _I = V _{CC} or GND; I _O = 0	3.6	–	0.1	10	μA
ΔI _{CC}	additional quiescent supply current per pin	V _I = V _{CC} - 0.6 V; I _O = 0	2.7 to 3.6	–	5	500	μA
I _{BHL}	bushold LOW sustaining current	V _I = 0.8 V; notes 4, 5 and 6	3.0	75	–	–	μA
I _{BHH}	bushold HIGH sustaining current	V _I = 2.0 V; notes 4, 5 and 6	3.0	-75	–	–	μA
I _{BHLO}	bushold LOW overdrive current	notes 4, 5 and 7	3.6	500	–	–	μA
I _{BHHO}	bushold HIGH overdrive current	notes 4, 5 and 7	3.6	-500	–	–	μA

勝特力材料 886-3-5753170
 勝特力电子(上海) 86-21-54151736
 勝特力电子(深圳) 86-755-83298787
[Http://www.100y.com.tw](http://www.100y.com.tw)

16-bit bus transceiver with direction pin; 5 V tolerant;
3-state

74LVCH16245A;
74LVCH16245A

SYMBOL	PARAMETER	TEST CONDITIONS		MIN.	TYP. (1)	MAX.	UNIT
		OTHER	V _{CC} (V)				
T_{amb} = -40 to +125 °C							
V _{IH}	HIGH-level input voltage		1.2	V _{CC}	–	–	V
			2.7 to 3.6	2.0	–	–	V
V _{IL}	LOW-level input voltage		1.2	–	–	GND	V
			2.7 to 3.6	–	–	0.8	V
V _{OH}	HIGH-level output voltage	V _I = V _{IH} or V _{IL} I _O = -100 μA	2.7 to 3.6	V _{CC} - 0.3	–	–	V
		I _O = -12 mA	2.7	V _{CC} - 0.65	–	–	V
		I _O = -18 mA	3.0	V _{CC} - 0.75	–	–	V
		I _O = -24 mA	3.0	V _{CC} - 1	–	–	V
V _{OL}	LOW-level output voltage	V _I = V _{IH} or V _{IL} I _O = 100 μA	2.7 to 3.6	–	0	0.3	V
		I _O = 12 mA	2.7	–	–	0.6	V
		I _O = 24 mA	3.0	–	–	0.8	V
I _{LI}	input leakage current	V _I = 5.5 V or GND ; note 2	3.6	–	–	±20	μA
I _{OZ}	3-state output OFF-state current	V _I = V _{IH} or V _{IL} ; V _O = 5.5 V or GND; D; notes 2 and 3	3.6	–	–	±20	μA
I _{off}	power off leakage supply	V _I or V _O = 5.5 V	0.0	–	–	±20	μA
I _{CC}	quiescent supply current	V _I = V _{CC} or GND; I _O = 0	3.6	–	–	40	μA
ΔI _{CC}	additional quiescent supply current per pin	V _I = V _{CC} - 0.6 V; I _O = 0	2.7 to 3.6	–	–	5000	μA
I _{BHL}	bushold LOW sustaining current	V _I = 0.8 V; notes 4, 5 and 6	3.0	60	–	–	μA
I _{BHH}	bushold HIGH sustaining current	V _I = 2.0 V; notes 4, 5 and 6	3.0	-60	–	–	μA
I _{BHLO}	bushold LOW overdrive current	notes 4, 5 and 7	3.6	500	–	–	μA
I _{BHHO}	bushold HIGH overdrive current	notes 4, 5 and 7	3.6	-500	–	–	μA

Notes

1. All typical values are measured at V_{CC} = 3.3 V and T_{amb} = 25 °C.
2. For bushold parts, the bushold circuit is switched off when V_I > V_{CC} allowing 5.5 V on the input terminal.
3. For I/O ports the parameter I_{OZ} includes the input leakage current.
4. Valid for data inputs of bushold parts (74LVCH16245A) only.
5. For data inputs only, control inputs do not have a bushold circuit.
6. The specified sustaining current at the data input holds the input below the specified V_I level.
7. The specified overdrive current at the data input forces the data input to the opposite input state.

16-bit bus transceiver with direction pin; 5 V tolerant;
3-state

74LVC16245A;
74LVCH16245A

AC CHARACTERISTICS

GND = 0 V; $t_r = t_f \leq 2.5$ ns.

SYMBOL	PARAMETER	TEST CONDITIONS		MIN.	TYP. ⁽¹⁾	MAX.	UNIT
		WAVEFORMS	V _{CC} (V)				
T_{amb} = -40 to +85 °C							
t _{PHL} /t _{PLH}	propagation delay nAn to nBn; nBn to nAn	see Figs 6 and 8	1.2	–	13.0	–	ns
			2.7	1.0	2.7	4.7	ns
			3.0 to 3.6	1.0	2.2 ⁽²⁾	4.5	ns
t _{PZH} /t _{PZL}	3-state output enable time n \overline{OE} to nAn; n \overline{OE} to nBn	see Figs 7 and 8	1.2	–	15.0	–	ns
			2.7	1.5	3.6	6.7	ns
			3.0 to 3.6	1.0	2.8 ⁽²⁾	5.5	ns
t _{PHZ} /t _{PLZ}	3-state output disable time n \overline{OE} to nAn; n \overline{OE} to nBn	see Figs 7 and 8	1.2	–	11.0	–	ns
			2.7	1.5	3.4	6.6	ns
			3.0 to 3.6	1.5	3.2 ⁽²⁾	5.6	ns
T_{amb} = -40 to +125 °C							
t _{PHL} /t _{PLH}	propagation delay nAn to nBn; nBn to nAn	see Figs 6 and 8	1.2	–	–	–	ns
			2.7	1.0	–	6.0	ns
			3.0 to 3.6	1.0	–	6.0	ns
t _{PZH} /t _{PZL}	3-state output enable time n \overline{OE} to nAn; n \overline{OE} to nBn	see Figs 7 and 8	1.2	–	–	–	ns
			2.7	1.5	–	8.5	ns
			3.0 to 3.6	1.0	–	7.0	ns
t _{PHZ} /t _{PLZ}	3-state output disable time n \overline{OE} to nAn; n \overline{OE} to nBn	see Figs 7 and 8	1.2	–	–	–	ns
			2.7	1.5	–	8.5	ns
			3.0 to 3.6	1.5	–	7.0	ns

Notes

- All typical values are measured at T_{amb} = 25 °C.
- Typical values are measured at V_{CC} = 3.3 V and T_{amb} = 25 °C.

勝特力材料 886-3-5753170
 勝特力电子(上海) 86-21-54151736
 勝特力电子(深圳) 86-755-83298787
[Http://www.100y.com.tw](http://www.100y.com.tw)

16-bit bus transceiver with direction pin; 5 V tolerant;
3-state

74LVC16245A;
74LVCH16245A

AC WAVEFORMS

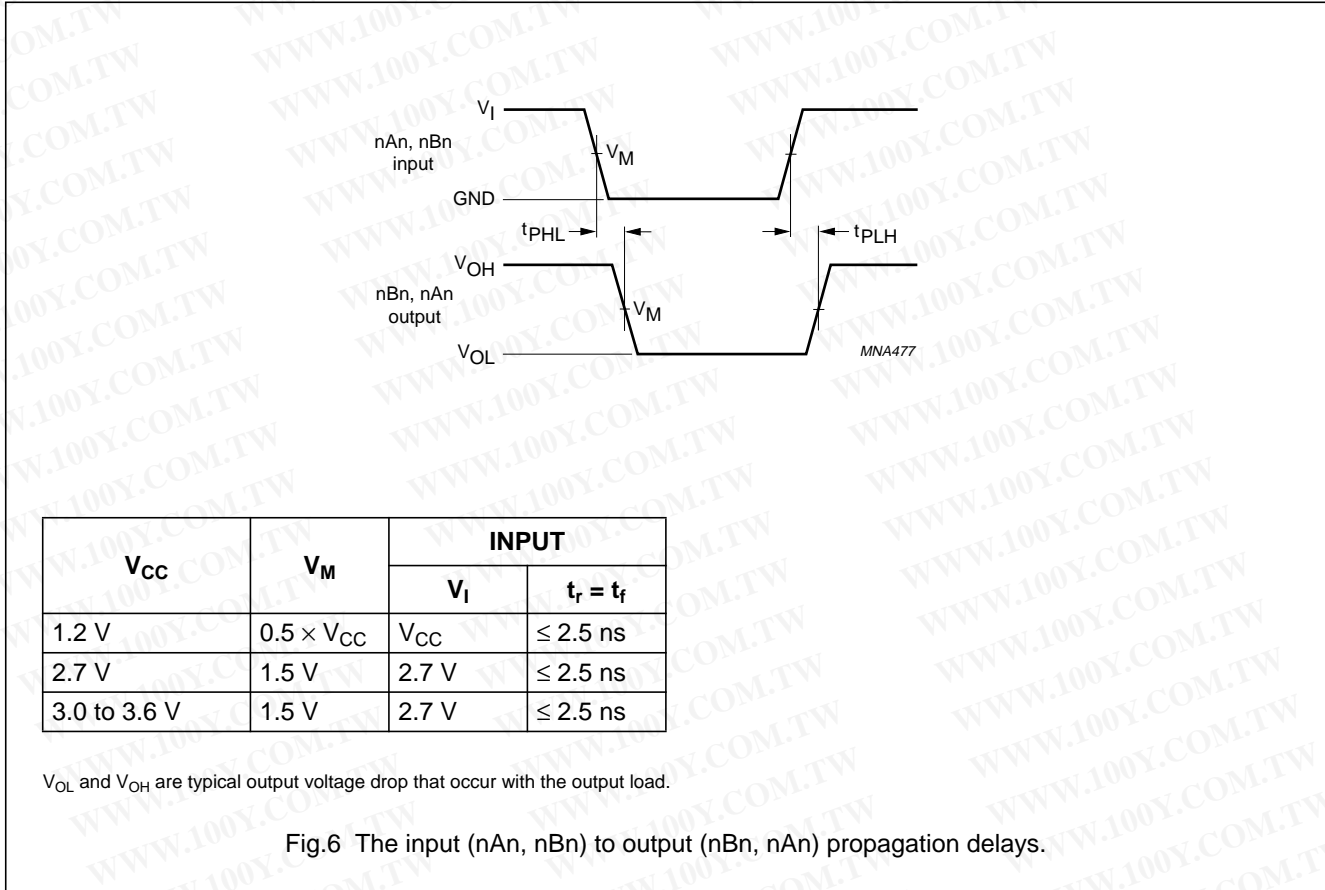

勝特力材料 886-3-5753170
 勝特力电子(上海) 86-21-54151736
 勝特力电子(深圳) 86-755-83298787
[Http://www.100y.com.tw](http://www.100y.com.tw)

16-bit bus transceiver with direction pin; 5 V tolerant;
3-state

74LVC16245A;
74LVCH16245A

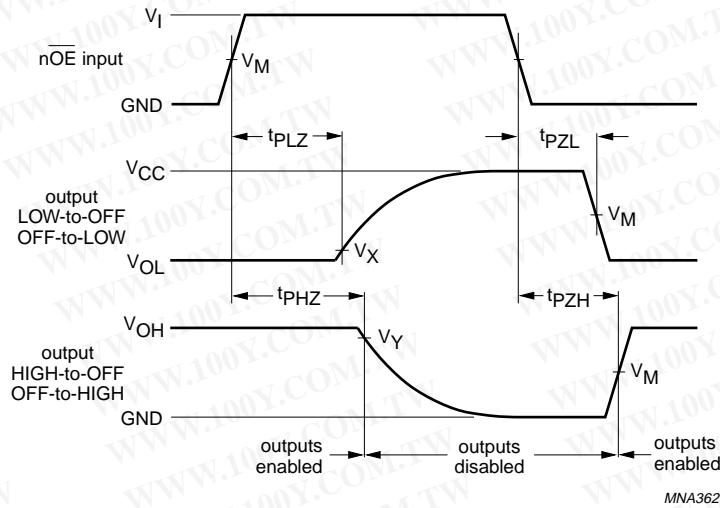

V _{CC}	V _M	INPUT	
		V _I	t _r = t _f
1.2 V	0.5 × V _{CC}	V _{CC}	≤ 2.5 ns
2.7 V	1.5 V	2.7 V	≤ 2.5 ns
3.0 to 3.6 V	1.5 V	2.7 V	≤ 2.5 ns

V_X = V_{OL} + 0.3 V at V_{CC} ≥ 2.7 V;
 V_X = V_{OL} + 0.1 V at V_{CC} < 2.7 V;
 V_Y = V_{OH} - 0.3 V at V_{CC} ≥ 2.7 V;
 V_Y = V_{OH} - 0.1 V at V_{CC} < 2.7 V.

V_{OL} and V_{OH} are typical output voltage drop that occur with the output load.

Fig.7 3-state enable and disable times.

勝特力材料 886-3-5753170
 勝特力电子(上海) 86-21-54151736
 勝特力电子(深圳) 86-755-83298787
[Http://www.100y.com.tw](http://www.100y.com.tw)

16-bit bus transceiver with direction pin; 5 V tolerant;
3-state

74LVC16245A;
74LVCH16245A

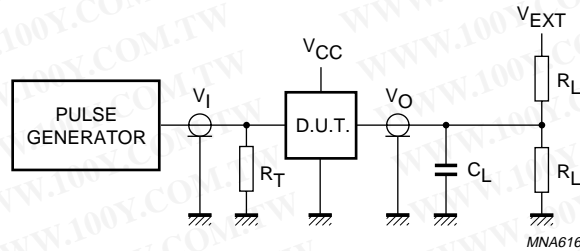

V _{CC}	V _I	C _L	R _L ⁽¹⁾	V _{EXT}		
				t _{PLH} /t _{PHL}	t _{PZH} /t _{PHZ}	t _{PZL} /t _{PLZ}
1.2 V	V _{CC}	50 pF	500 Ω	open	GND	2 × V _{CC}
2.7 V	2.7 V	50 pF	500 Ω	open	GND	2 × V _{CC}
3.0 to 3.6 V	2.7 V	50 pF	500 Ω	open	GND	2 × V _{CC}

Note

1. The circuit performs better when R_L = 1000 Ω.

Definitions for test circuit:

R_L = Load resistor.

C_L = Load capacitance including jig and probe capacitance.

R_T = Termination resistance should be equal to the output impedance Z_o of the pulse generator.

Fig.8 Load circuitry for switching times.

勝特力材料 886-3-5753170
 勝特力电子(上海) 86-21-54151736
 勝特力电子(深圳) 86-755-83298787
[Http://www.100y.com.tw](http://www.100y.com.tw)

16-bit bus transceiver with direction pin; 5 V tolerant;
3-state

74LVC16245A;
74LVCH16245A

PACKAGE OUTLINES

SSOP48: plastic shrink small outline package; 48 leads; body width 7.5 mm

SOT370-1

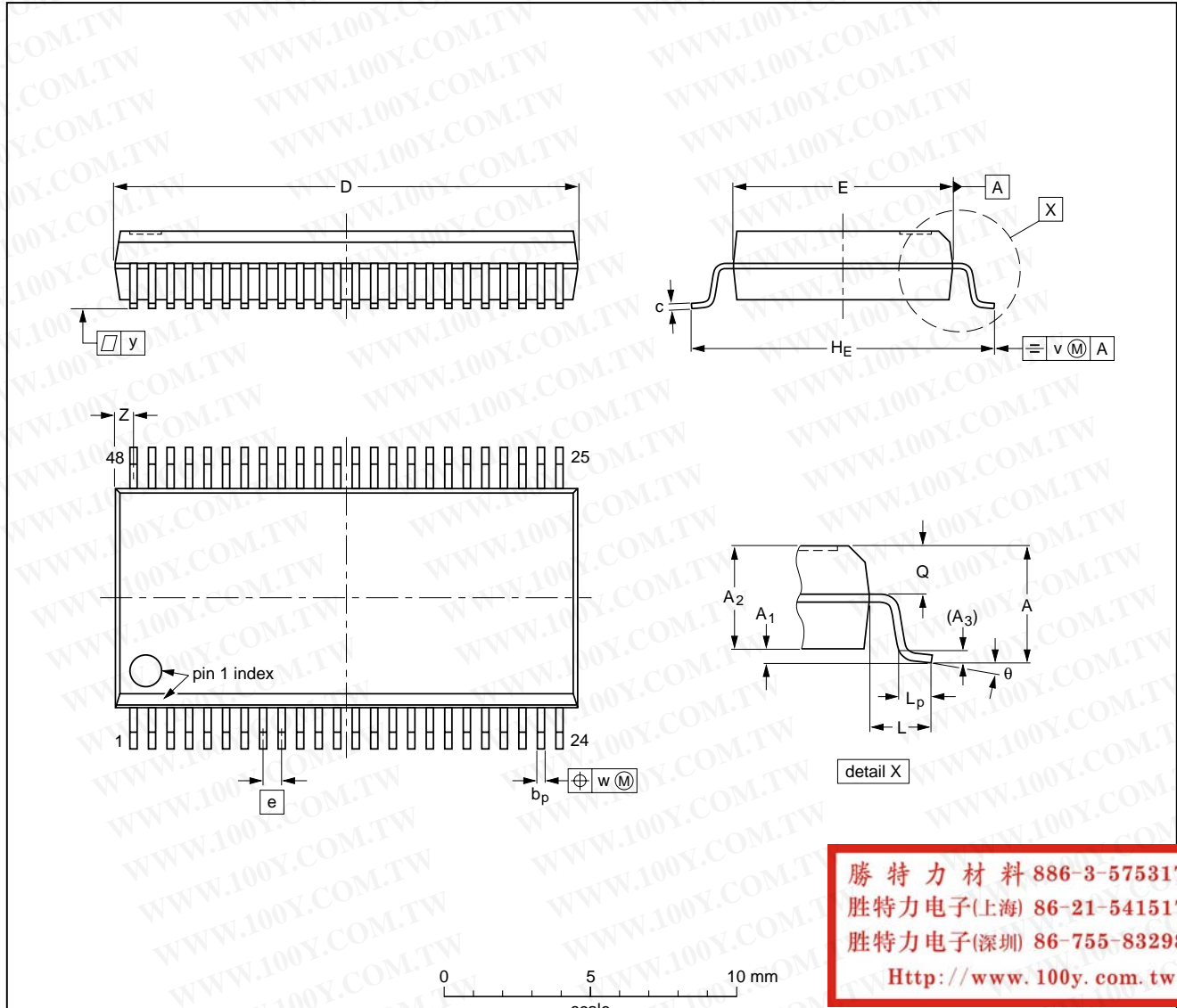

勝特力材料 886-3-5753170
 勝特力电子(上海) 86-21-54151736
 勝特力电子(深圳) 86-755-83298787
[Http://www.100y.com.tw](http://www.100y.com.tw)

DIMENSIONS (mm are the original dimensions)

UNIT	A max.	A ₁	A ₂	A ₃	b _p	c	D ⁽¹⁾	E ⁽¹⁾	e	H _E	L	L _p	Q	v	w	y	Z ⁽¹⁾	θ
mm	2.8	0.4 0.2	2.35 2.20	0.25	0.3 0.2	0.22 0.13	16.00 15.75	7.6 7.4	0.635	10.4 10.1	1.4	1.0 0.6	1.2 1.0	0.25	0.18	0.1	0.85 0.40	8° 0°

Note

1. Plastic or metal protrusions of 0.25 mm maximum per side are not included.

OUTLINE VERSION	REFERENCES				EUROPEAN PROJECTION	ISSUE DATE
	IEC	JEDEC	JEITA			
SOT370-1		MO-118				99-12-27 03-02-19

16-bit bus transceiver with direction pin; 5 V tolerant;
3-state

74LVC16245A;
74LVCH16245A

TSSOP48: plastic thin shrink small outline package; 48 leads; body width 6.1 mm

SOT362-1

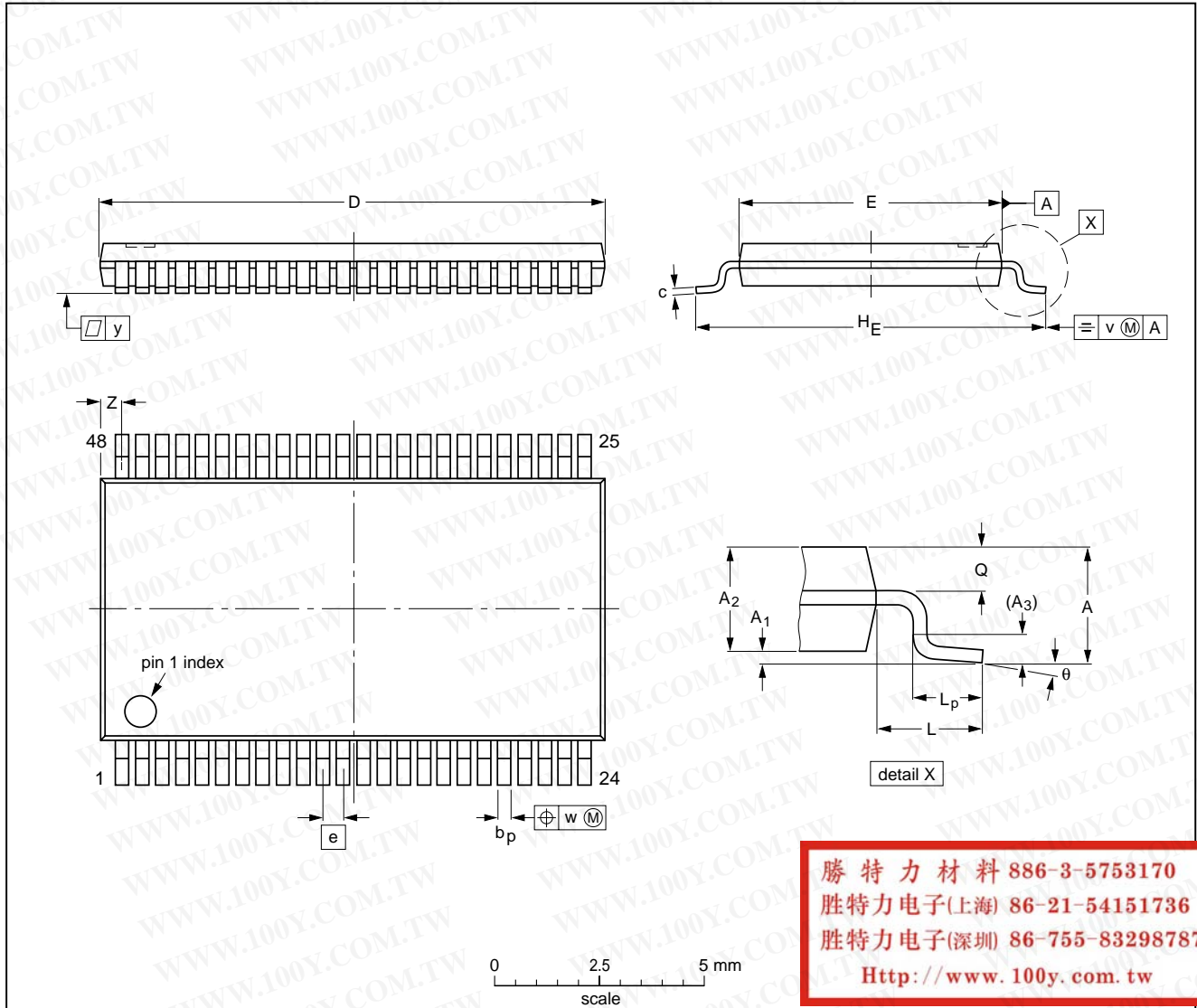

勝特力材料 886-3-5753170
 勝特力电子(上海) 86-21-54151736
 勝特力电子(深圳) 86-755-83298787
[Http://www.100y.com.tw](http://www.100y.com.tw)

DIMENSIONS (mm are the original dimensions).

UNIT	A max.	A ₁	A ₂	A ₃	b _p	c	D ⁽¹⁾	E ⁽²⁾	e	H _E	L	L _p	Q	v	w	y	Z	θ
mm	1.2	0.15 0.05	1.05 0.85	0.25	0.28 0.17	0.2 0.1	12.6 12.4	6.2 6.0	0.5	8.3 7.9	1	0.8 0.4	0.50 0.35	0.25	0.08	0.1	0.8 0.4	8° 0°

Notes

1. Plastic or metal protrusions of 0.15 mm maximum per side are not included.
2. Plastic interlead protrusions of 0.25 mm maximum per side are not included.

OUTLINE VERSION	REFERENCES			EUROPEAN PROJECTION	ISSUE DATE
	IEC	JEDEC	JEITA		
SOT362-1		MO-153			-99-12-27 03-02-19

16-bit bus transceiver with direction pin; 5 V tolerant;
3-state

74LVC16245A;
74LVCH16245A

VFBGA56: plastic very thin fine-pitch ball grid array package; 56 balls; body 4.5 x 7 x 0.65 mm

SOT702-1

勝特力材料 886-3-5753170
 勝特力电子(上海) 86-21-54151736
 勝特力电子(深圳) 86-755-83298787
[Http://www.100y.com.tw](http://www.100y.com.tw)

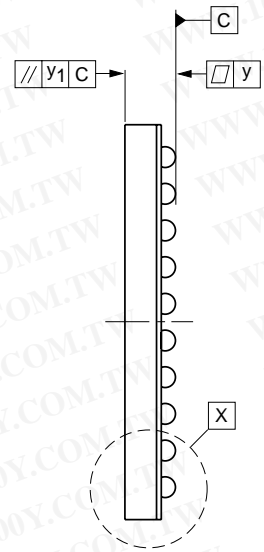
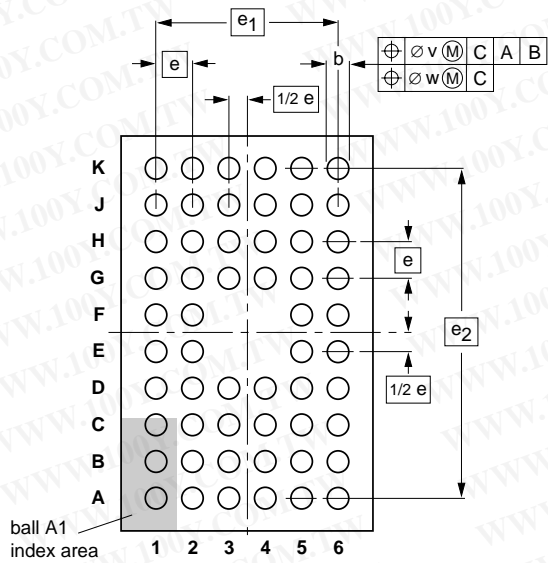
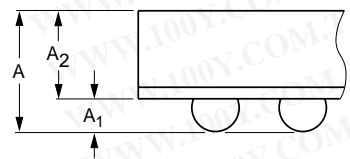
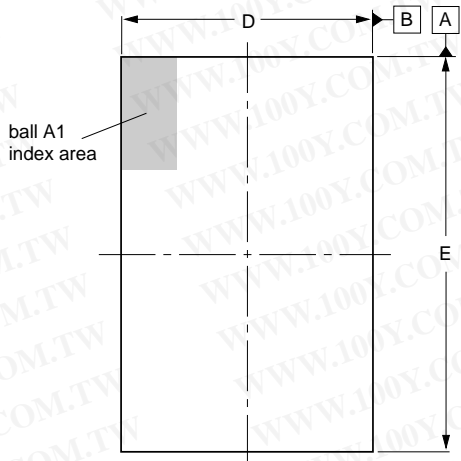

DIMENSIONS (mm are the original dimensions)

UNIT	A max.	A ₁	A ₂	b	D	E	e	e ₁	e ₂	v	w	y	y ₁
mm	1	0.3 0.2	0.7 0.6	0.45 0.35	4.6 4.4	7.1 6.9	0.65	3.25	5.85	0.15	0.08	0.08	0.1

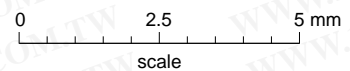

OUTLINE VERSION	REFERENCES			EUROPEAN PROJECTION	ISSUE DATE
	IEC	JEDEC	JEITA		
SOT702-1		MO-225			02-08-08 03-07-01

16-bit bus transceiver with direction pin; 5 V tolerant;
3-state

74LVC16245A;
74LVCH16245A

DATA SHEET STATUS

LEVEL	DATA SHEET STATUS ⁽¹⁾	PRODUCT STATUS ⁽²⁾⁽³⁾	DEFINITION
I	Objective data	Development	This data sheet contains data from the objective specification for product development. Philips Semiconductors reserves the right to change the specification in any manner without notice.
II	Preliminary data	Qualification	This data sheet contains data from the preliminary specification. Supplementary data will be published at a later date. Philips Semiconductors reserves the right to change the specification without notice, in order to improve the design and supply the best possible product.
III	Product data	Production	This data sheet contains data from the product specification. Philips Semiconductors reserves the right to make changes at any time in order to improve the design, manufacturing and supply. Relevant changes will be communicated via a Customer Product/Process Change Notification (CPCN).

Notes

1. Please consult the most recently issued data sheet before initiating or completing a design.
2. The product status of the device(s) described in this data sheet may have changed since this data sheet was published. The latest information is available on the Internet at URL <http://www.semiconductors.philips.com>.
3. For data sheets describing multiple type numbers, the highest-level product status determines the data sheet status.

DEFINITIONS

Short-form specification — The data in a short-form specification is extracted from a full data sheet with the same type number and title. For detailed information see the relevant data sheet or data handbook.

Limiting values definition — Limiting values given are in accordance with the Absolute Maximum Rating System (IEC 60134). Stress above one or more of the limiting values may cause permanent damage to the device. These are stress ratings only and operation of the device at these or at any other conditions above those given in the Characteristics sections of the specification is not implied. Exposure to limiting values for extended periods may affect device reliability.

Application information — Applications that are described herein for any of these products are for illustrative purposes only. Philips Semiconductors make no representation or warranty that such applications will be suitable for the specified use without further testing or modification.

DISCLAIMERS

Life support applications — These products are not designed for use in life support appliances, devices, or systems where malfunction of these products can reasonably be expected to result in personal injury. Philips Semiconductors customers using or selling these products for use in such applications do so at their own risk and agree to fully indemnify Philips Semiconductors for any damages resulting from such application.

Right to make changes — Philips Semiconductors reserves the right to make changes in the products - including circuits, standard cells, and/or software - described or contained herein in order to improve design and/or performance. When the product is in full production (status 'Production'), relevant changes will be communicated via a Customer Product/Process Change Notification (CPCN). Philips Semiconductors assumes no responsibility or liability for the use of any of these products, conveys no licence or title under any patent, copyright, or mask work right to these products, and makes no representations or warranties that these products are free from patent, copyright, or mask work right infringement, unless otherwise specified.

Philips Semiconductors – a worldwide company

勝特力材料 886-3-5753170
勝特力电子(上海) 86-21-54151736
勝特力电子(深圳) 86-755-83298787
[Http://www.100y.com.tw](http://www.100y.com.tw)

Contact information

For additional information please visit <http://www.semiconductors.philips.com>. Fax: +31 40 27 24825

For sales offices addresses send e-mail to: sales.addresses@www.semiconductors.philips.com.

© Koninklijke Philips Electronics N.V. 2003

SCA75

All rights are reserved. Reproduction in whole or in part is prohibited without the prior written consent of the copyright owner.

The information presented in this document does not form part of any quotation or contract, is believed to be accurate and reliable and may be changed without notice. No liability will be accepted by the publisher for any consequence of its use. Publication thereof does not convey nor imply any license under patent- or other industrial or intellectual property rights.

Printed in The Netherlands

R20/07/pp19

Date of release: 2003 Nov 25

Document order number: 9397 750 12155

Let's make things better.

**Philips
Semiconductors**



PHILIPS