

勝特力材料 886-3-5753170
勝特力电子(上海) 86-21-34970699
勝特力电子(深圳) 86-755-83298787
[Http://www.100y.com.tw](http://www.100y.com.tw)



ASIMETO

CATALOG NO. AS1617

INDEX

7 Micrometers



47 Calipers



77 Depth & Height Gauges

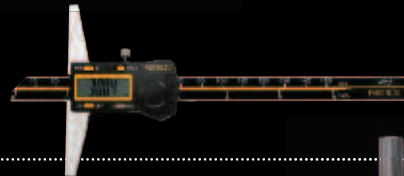

89 Indicator & Dial Gauges



131 Bore Gauges



137 Other Gauges



161 Gauges



183 Testers & Optical Instrument

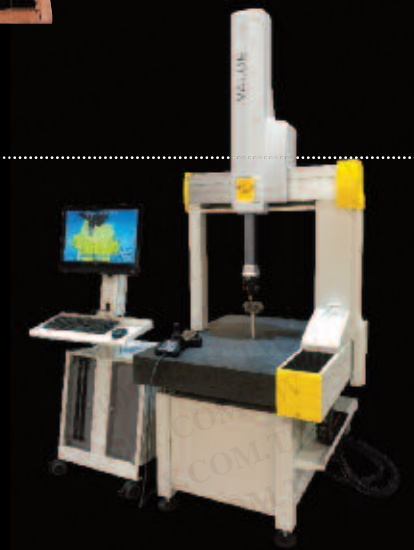

Precision

is not only defined by degrees of exactness. It is defined by the vision and skill of engineers. By problems solved, challenges overcome and reputations made. The real value of precision is the power it gives engineers to turn plans into reality.

ASIMETO – Empowering Possibilities.

Asimeto was founded in 2004 by renowned German metrologist Manfred Eisinger. Since then, the company has rapidly established a reputation for manufacturing high-performance precision tools and solutions and delivering them at unexpectedly affordable prices.

Asimeto continues to win market share by applying German metrological design, American technological innovation and Asian manufacturing competitiveness across a broad range of integrated precision solutions, distributed through a global network. Every tool is ISO17025 certified for dependable accuracy and to ensure calibration is compliant with the regulatory requirements of each local market. Increasingly, Asimeto is the choice of engineers the world over including companies like Volkswagen, Guhring and Boeing. We invite you to discover why.

Asimeto Calibration Laboratory

The quality and measuring accuracy of all Asimeto precision tools is guaranteed by the Asimeto Calibration Laboratory. All tools are inspected for conformance to the Asimeto design specifications and are then processed through the Asimeto calibration laboratory. Only the latest state of the art calibration equipment has been selected, from the leading global manufacturers, to ensure that the calibration costs are contained by increasing throughput, without compromising measurement accuracy or repeatability.

The Asimeto Calibration Laboratory has designed and incorporated universal calibration software that applies the applicable accuracy standard to the specific destination market of the precision measuring tool. ASME, DIN and JIG are all supported.

It all means precisely that the dedication and diligence of the Asimeto Calibration Laboratory assures you that the accuracy is within the specifications of your local standard.

ASIMETO

Calibration Lab

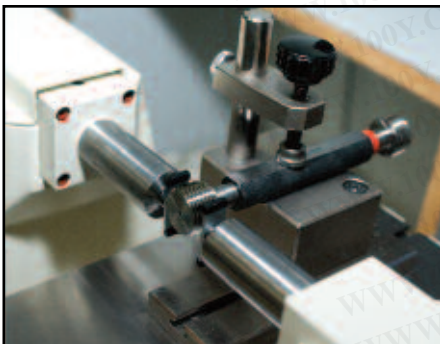
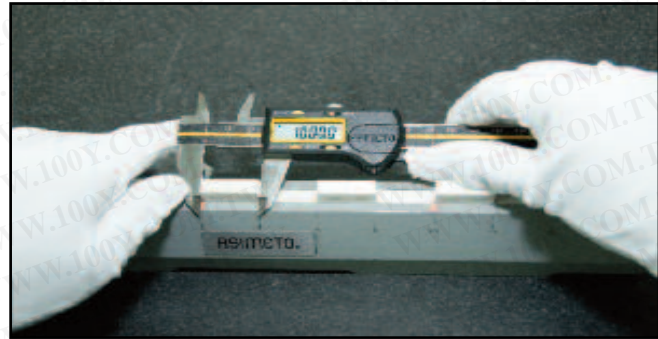
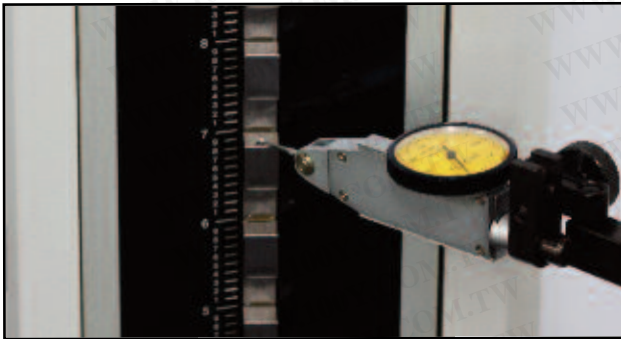

2

Product Description

Calibration Certificate



Certificate No	G30001	Tool	0-150mm/0-6"
Part Number	307-06-0	Range	0.01mm/0.0005"
Serial Number	GS102042	Resolution	Digital Calipers
Standard Name	ASME B89.1.14		

Function Inspection	Passed	Visual Inspection	Passed
---------------------	--------	-------------------	--------

Outside Measurements

Reading	Nominal Value	Tolerance +/-	Deviation	Disposition*
1	0.0000"	±0.001"	0.0000	✓
2	1.0000"	±0.001"	-0.0010	✓
3	3.0000"	±0.001"	-0.0010	✓
4	4.5000"	±0.001"	-0.0015	✓
5	6.0000"	±0.001"	-0.0015	✓

Inside Measurements

Reading	Nominal Value	Tolerance +/-	Deviation	Disposition*
6	0.2000"	±0.001"	0.0010	✓
7	1.0000"	±0.001"	0.0010	✓

Depth Measurements

Reading	Nominal Value	Tolerance +/-	Deviation	Disposition*
8	0.0000"	±0.001"	0.0000	✓

Master information

Master information		Due Date	
Depth set	258254	NIST-192837	2013-8-1
Gauge Block Set	258254	NIST-95837	2013-8-1
Setting Rings	258254	NIST-45837	2013-8-1

Uncertainty 6 μm +10⁻⁶×L Temperature 20 °C ±0.5 °C Humidity 50 % ±15 %

Attach invoice for proof of purchase date
* Check mark indicates within tolerance

Calibrator

Approved By

Asimeto (Guangzhou) Inc. Calibration Lab.
402 Building B, Yushu Industrial Zone, Lubgang District, Guangzhou China;
Tel: 020-82019119 Fax: 020-82261



Inspection Point & Result

1

Disposition

3

Traceable No.

4

Data Collection Measuring Tools



The virtual keyboard collects data and transmits directly into Microsoft standard software (Excel, Access)



MeasureReport

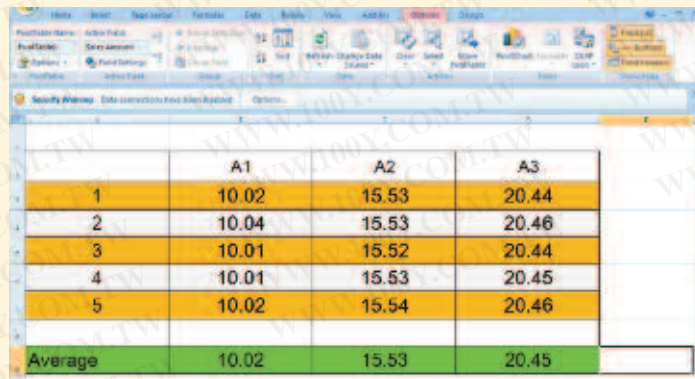

	A1	A2	A3
1	10.02	15.53	20.44
2	10.04	15.53	20.46
3	10.01	15.52	20.44
4	10.01	15.53	20.45
5	10.02	15.54	20.46
Average	10.02	15.53	20.45

ASIMETO DATA OUTPUT CABLE



Data Output Cable

900 Series

	Used For	Interface to PC	Data	corresponding	Code No.
	ABS Digital caliper	USB	Dot Data Format	307-XX-2 ; 307-XX-3	900-05-4
	Digital Micrometer	USB	Dot Data Format	105-XX-4 ; 105-XX-5	900-05-4
	Heavy Duty Digital Calipers	USB	Dot Data Format	315-XX-6 ; 315-XX-8	900-05-4
	ABS Digital caliper	USB	Comma Data Format	307-XX-2 ; 307-XX-3	900-05-5
	Digital Micrometer	USB	Comma Data Format	105-XX-4 ; 105-XX-5	900-05-5
	Heavy Duty Digital Calipers	USB	Comma Data Format	315-XX-6 ; 315-XX-8	900-05-5
	Digital Indicator	USB	Dot Data Format	405-95-X ; 405-01-X 405-02-X ; 405-04-X	900-20-0
	IP65 Digital Indicator	USB	Dot Data Format	407-XX-2 ; 407-XX-3 407-XX-4 ; 407-XX-5	900-07-0
	IP65 Digital Indicator	USB	Comma Data Format	407-XX-2 ; 407-XX-3 407-XX-4 ; 407-XX-5	900-07-1

Wireless Data Output Cable

901 Series

	Used For	Function	Frequency	Code No.
	ABS Digital caliper Digital Micrometer Heavy Duty Digital Calipers	Output	2.4G	901-00-1
	IP65 Digital Indicator	Output	2.4G	901-00-2
	ABS Digital caliper Digital Micrometer Heavy Duty Digital Calipers IP65 Digital Indicator	Input	2.4G	901-00-3

Micrometers

7	IP65 Digital Outside Micrometers	28	Screw Thread Micrometers
9	Digital Outside Micrometers	29	Disc Micrometers
10	Outside Micrometers	30	Jaw Type Micrometers
11	Outside Micrometers Sets	31	Universal Micrometers
12	Interchangeable Anvil Outside Micrometers	32	V-Anvil Micrometers
13	Indicating Micrometers	33	Tube Micrometers
14	Two and Three Point Internal Micrometers (2-12mm/.08-.5")	35	Deep Throat Micrometers
15	Three-Point Internal Micrometers (12-100mm/.5-4.0")	36	Limit Micrometers
16	Three-Point Internal Micrometers (100-300mm/4.0-12.0")	36	Wire Micrometers
17	Two and Three Point Internal Micrometers Sets	37	Sheet Metal Micrometers
18	Inside Micrometers	37	Hub Micrometers
19	Dual Measurement Inside Micrometers	38	Groove Micrometers
19	Tubular Inside Micrometers	39	Snap Gauges
20	Inside Micrometers - Interchangeable Rod Type	40	Can Seam Micrometers
21	Quick-Setting Outside Micrometers, 1mm Rev	40	Digital Micrometer Heads
21	Micrometer Stands	41	Micrometer Heads
22	Blade Micrometers	47	Depth Micrometers
23	Multi-Anvil Micrometers	48	Micrometer Standards
24	Point Micrometers	49	Micrometer Anvil Attachments
25	Single Point Micrometers	49	Thread Measuring Triangle Set
26	Spline Micrometers		
27	Gear Tooth Micrometers		

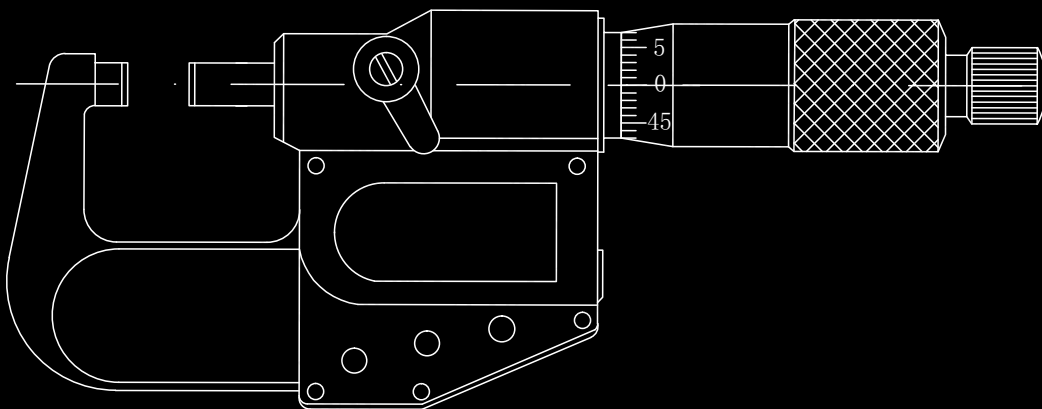



IP65 Digital Outside Micrometers

105 Series



105-01-4



105-66-8



Ball Anvil



S-wrench



Standard

FEATURES

- Resolution:
Digital: .00005"/ 0.001mm
- Flatness: .000012"/ 0.3µm
- Protection level IP65
- Carbide tipped measuring faces
- Cable data output: 900-05-4/5
- Wireless data output: 901-00-1
- Upon switch on the display will read the actual absolute measuring position
- Automatic Off to maximize battery life
- Inch/Metric conversion
- Absolute or incremental measuring modes
- Grey painted steel frame

STANDARD ACCESSORIES

- S-wrench, Battery, Standard (over 1"/25mm range)
- Warranty card, Calibration certificate, Instruction manual

SPECIFICATIONS

Inch		Metric		With Data Output		
Range	Accuracy	Range	Accuracy	Thimble	Inch Code No.	Metric Code No.
0-1"	±.0001"	0-25mm	±0.002mm	dual ratchets	105-01-5	105-01-4
1-2"	±.0002"	25-50mm	±0.002mm	dual ratchets	105-02-5	105-02-4
2-3"	±.0002"	50-75mm	±0.003mm	dual ratchets	105-03-5	105-03-4
3-4"	±.0002"	75-100mm	±0.003mm	dual ratchets	105-04-5	105-04-4
4-5"	±.0002"	100-125mm	±0.003mm	dual ratchets	105-05-5	105-05-4
5-6"	±.0002"	125-150mm	±0.003mm	dual ratchets	105-06-5	105-06-4
Sets						
Range	Quantity	Range	Quantity	Thimble		
0-3"	3	0-75mm	3	dual ratchets	105-63-9	105-63-8
0-4"	4	0-100mm	4	dual ratchets	105-64-9	105-64-8
0-6"	6	0-150mm	6	dual ratchets	105-66-9	105-66-8



IP65 Digital Outside Micrometers

105 Series



Ratchet Stop

105-07-0



S-wrench



Ball Anvil



Standard

FEATURES

- Resolution:
Digital: .00005"/ 0.001mm
Scale: .0001"/ 0.01mm
- Flatness: .000012"/ 0.3µm
- Protection level IP65
- Ratchet Stop and Ratchet Thimble are optional
- Upon switch on the display will read the actual absolute measuring position
- Automatic On/Off to maximize battery life
- Inch/Metric conversion
- Absolute or incremental measuring modes
- Carbide tipped measuring faces
- Grey painted steel frame

STANDARD ACCESSORIES

- S-wrench, Battery, Ball Anvil, Standard (over 1"/25mm range)
- Warranty card, Calibration certificate, Instruction manual

SPECIFICATIONS

Inch		Metric		Thimble	W/O Data Output	
Range	Accuracy	Range	Accuracy		Inch Code No.	Metric Code No.
6-7"	±.0002"	150-175mm	±0.004mm	Ratchet	105-07-1	105-07-0
7-8"	±.0002"	175-200mm	±0.004mm	Ratchet	105-08-1	105-08-0
8-9"	±.0002"	200-225mm	±0.004mm	Ratchet	105-09-1	105-09-0
9-10"	±.0003"	225-250mm	±0.004mm	Ratchet	105-10-1	105-10-0
10-11"	±.0003"	250-275mm	±0.005mm	Ratchet	105-11-1	105-11-0
11-12"	±.0003"	275-300mm	±0.005mm	Ratchet	105-12-1	105-12-0



Digital Outside Micrometers

116 Series



116-01-0



Ball Anvil



Standard

FEATURES

- Resolution: .00005"/ 0.001mm
- Carbide tipped measuring faces
- Spindle dia.: 0.25"
- Painted frame.
- Ratchet friction thimble
- Inch/Metric conversion
- Absolute or incremental measuring modes
- Automatic On/Off to maximize battery life

STANDARD ACCESSORIES

- Battery, Ball Anvil, Standard (over 1"/25mm range)
- Warranty card, Calibration certificate, Instruction manual

SPECIFICATIONS

Inch		Metric		Inch	Metric
Range	Accuracy	Range	Accuracy	Code No.	Code No.
0-1"	±.00016"	0-25mm	±0.002mm	116-01-1	116-01-0
1-2"	±.00016"	25-50mm	±0.002mm	116-02-1	116-02-0
2-3"	±.0002"	50-75mm	±0.003mm	116-03-1	116-03-0
3-4"	±.0002"	75-100mm	±0.003mm	116-04-1	116-04-0
4-5"	±.00024"	100-125mm	±0.003mm	116-05-1	116-05-0
5-6"	±.00024"	125-150mm	±0.003mm	116-06-1	116-06-0
6-7"	±.00028"	150-175mm	±0.004mm	116-07-1	116-07-0
7-8"	±.00028"	175-200mm	±0.004mm	116-08-1	116-08-0
Sets					
Range	Quantity	Range	Quantity		
0-3"	3	0-75mm	3	116-63-1	116-63-0
0-4"	4	0-100mm	4	116-64-1	116-64-0

Dimension

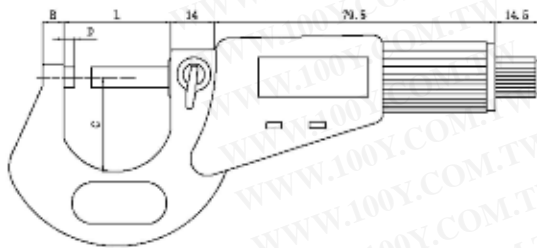

Range	C	L	B	D
Inch/Metric	mm	mm	mm	mm
0-1"/0-25mm	24	32	6	3
1-2"/25-50mm	32	57	8	3
2-3"/50-75mm	45	82	8	3
3-4"/75-100mm	57	107	10	3
4-5"/100-125mm	70	133	10	3
5-6"/125-150mm	82	158	10	3
6-7"/150-175mm	95	183	12	5.5
7-8"/175-200mm	107	209	12	5.5



Outside Micrometers

101 / 103 Series

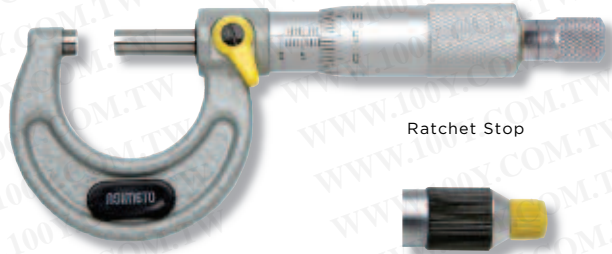

101-01-0

Ratchet Stop



Ratchet Thimble



S-wrench



Standard

FEATURES

- Graduation:
Inch: .001" / .0001"
Metric: 0.01mm / 0.001mm
- Flatness: .00024" / 0.6µm
- Carbide tipped measuring faces
- Ratchet Stop and Ratchet Thimble are optional
- Grey painted steel frame

STANDARD ACCESSORIES

- S-wrench, Standard (over 1"/25mm range)
- Warranty card, Instruction manual, Calibration certificate

SPECIFICATIONS

Inch			Metric			Ratchet Stop		Ratchet Thimble	
Range	Graduation	Accuracy	Range	Graduation	Accuracy	Inch Code No.	Metric Code No.	Inch Code No.	Metric Code No.
0-1"	.001"	±.0001"	0-25mm	0.01mm	±0.004mm	101-01-1	101-01-0	103-01-5	103-01-4
1-2"	.001"	±.0002"	25-50mm	0.01mm	±0.004mm	101-02-1	101-02-0	103-02-5	103-02-4
2-3"	.001"	±.0002"	50-75mm	0.01mm	±0.005mm	101-03-1	101-03-0	103-03-5	103-03-4
3-4"	.001"	±.0002"	75-100mm	0.01mm	±0.005mm	101-04-1	101-04-0	103-04-5	103-04-4
4-5"	.001"	±.0002"	100-125mm	0.01mm	±0.006mm	101-05-1	101-05-0	103-05-5	103-05-4
5-6"	.001"	±.0002"	125-150mm	0.01mm	±0.006mm	101-06-1	101-06-0	103-06-5	103-06-4
6-7"	.001"	±.0002"	150-175mm	0.01mm	±0.007mm	101-07-1	101-07-0	103-07-5	103-07-4
7-8"	.001"	±.0002"	175-200mm	0.01mm	±0.007mm	101-08-1	101-08-0	103-08-5	103-08-4
8-9"	.001"	±.0002"	200-225mm	0.01mm	±0.008mm	101-09-1	101-09-0	103-09-5	103-09-4
9-10"	.001"	±.0003"	225-250mm	0.01mm	±0.008mm	101-10-1	101-10-0	103-10-5	103-10-4
10-11"	.001"	±.0003"	250-275mm	0.01mm	±0.009mm	101-11-1	101-11-0	103-11-5	103-11-4
11-12"	.001"	±.0003"	275-300mm	0.01mm	±0.009mm	101-12-1	101-12-0	103-12-5	103-12-4
0-1"	.0001"	±.0001"	0-25mm	0.001mm	±0.004mm	101-01-3	101-01-2	103-01-7	103-01-6
1-2"	.0001"	±.0002"	25-50mm	0.001mm	±0.004mm	101-02-3	101-02-2	103-02-7	103-02-6
2-3"	.0001"	±.0002"	50-75mm	0.001mm	±0.005mm	101-03-3	101-03-2	103-03-7	103-03-6
3-4"	.0001"	±.0002"	75-100mm	0.001mm	±0.005mm	101-04-3	101-04-2	103-04-7	103-04-6
4-5"	.0001"	±.0002"	100-125mm	0.001mm	±0.006mm	101-05-3	101-05-2	103-05-7	103-05-6
5-6"	.0001"	±.0002"	125-150mm	0.001mm	±0.006mm	101-06-3	101-06-2	103-06-7	103-06-6
6-7"	.0001"	±.0002"	150-175mm	0.001mm	±0.007mm	101-07-3	101-07-2	103-07-7	103-07-6
7-8"	.0001"	±.0002"	175-200mm	0.001mm	±0.007mm	101-08-3	101-08-2	103-08-7	103-08-6
8-9"	.0001"	±.0002"	200-225mm	0.001mm	±0.008mm	101-09-3	101-09-2	103-09-7	103-09-6
9-10"	.0001"	±.0003"	225-250mm	0.001mm	±0.008mm	101-10-3	101-10-2	103-10-7	103-10-6
10-11"	.0001"	±.0003"	250-275mm	0.001mm	±0.009mm	101-11-3	101-11-2	103-11-7	103-11-6
11-12"	.0001"	±.0003"	275-300mm	0.001mm	±0.009mm	101-12-3	101-12-2	103-12-7	103-12-6



Outside Micrometer Sets

101 Series



101-66-8

SPECIFICATIONS

Inch		Metric		Inch		Metric	
Range	Graduation	Range	Graduation	Code No.	Code No.	Code No.	Code No.
0-3"	.001"	0-75mm	0.01mm	101-63-9	101-63-8		
0-4"	.001"	0-100mm	0.01mm	101-64-9	101-64-8		
0-6"	.001"	0-150mm	0.01mm	101-66-9	101-66-8		
0-12"	.001"	0-300mm	0.01mm	101-72-9	101-72-8		
6-12"	.001"	150-300mm	0.01mm	101-82-9	101-82-8		
0-3"	.0001"	0-75mm	0.001mm	101-63-7	101-63-6		
0-4"	.0001"	0-100mm	0.001mm	101-64-7	101-64-6		
0-6"	.0001"	0-150mm	0.001mm	101-66-7	101-66-6		
0-12"	.0001"	0-300mm	0.001mm	101-72-7	101-72-6		
6-12"	.0001"	150-300mm	0.001mm	101-82-7	101-82-6		

Dimension

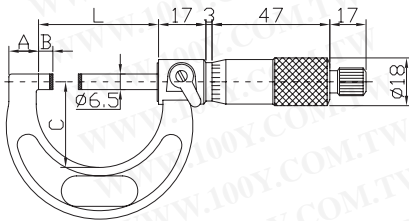

Range	A	B	C	L
Inch/Metric	mm	mm	mm	mm
0-1"/0-25mm	9	3	28	32
1-2"/25-50mm	14	3	38	57
2-3"/50-75mm	14.5	3	49	82
3-4"/75-100mm	15	3	60	107
4-5"/100-125mm	16.5	3	73	133
5-6"/125-150mm	16.5	3	85	158
6-7"/150-175mm	19.4	3	104	183
7-8"/175-200mm	19.4	3	117	209
8-9"/200-225mm	19.4	3	130	234
9-10"/225-250mm	19.4	3	142	260
10-11"/250-275mm	19.4	3	155	285
11-12"/275-300mm	19.4	3	168	310

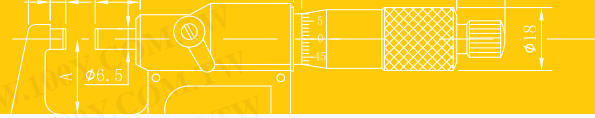

Interchangeable Anvil Outside Micrometers

111 / 115 Series



Digital models

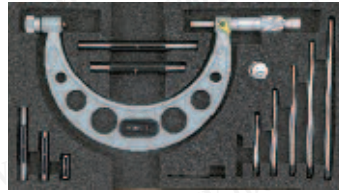

111-06-1



S-wrench



Torque Wrench



Battery



Guiding rings



Standard

STANDARD ACCESSORIES

- S-wrench, Battery (Digital models), Standards, Interchangeable Anvils, Torque Wrench, 2 Guiding rings
- Warranty card, Instruction manual, Calibration certificate

FEATURES

- Resolution:
 - Digital reading: .00005" / 0.001mm
 - Scale on digital models: .0001" / 0.01mm
 - Scale on mechanical models: .001" / 0.01mm
 - Flatness: .00004" / 1µm
- Ratchet stop
- Interchangeable anvils provide wider measuring ranges
- Carbide tipped measuring faces
- Grey painted steel frame for models up to 12"/300mm
- Grey welded pipe frame for models over 12"/300mm models
- Inch/Metric conversion
- Upon switching on the display will read the actual absolute measuring position
- Automatic On/Off to maximize battery life
- Absolute or incremental measuring modes
- Protection level IP65

SPECIFICATIONS

Inch		Metric				Digital models		Mechanical models	
Range	Accuracy	Range	Accuracy	Anvils	Standards	Inch Code No.	Metric Code No.	Inch Code No.	Metric Code No.
0-6"	±.0002"	0-150mm	±0.006mm	6 pcs	5 pcs	115-06-1	115-06-0	111-06-1	111-06-0
6-12"	±.0003"	150-300mm	±0.009mm	6 pcs	6 pcs	115-12-1	115-12-0	111-12-1	111-12-0
0-4"	±.0002"	0-100mm	±0.006mm	4 pcs	3 pcs	115-04-7	115-04-6	111-04-7	111-04-6
4-8"	±.0003"	100-200mm	±0.009mm	4 pcs	4 pcs	115-08-7	115-08-6	111-08-7	111-08-6
8-12"	±.0003"	200-300mm	±0.009mm	4 pcs	4 pcs	115-12-7	115-12-6	111-12-7	111-12-6
12-16"	±.0004"	300-400mm	±0.011mm	4 pcs	2 pcs	115-16-1	115-16-0	111-16-1	111-16-0
16-20"	±.0005"	400-500mm	±0.013mm	4 pcs	2 pcs	115-20-1	115-20-0	111-20-1	111-20-0
20-24"	±.0006"	500-600mm	±0.015mm	4 pcs	2 pcs	115-24-1	115-24-0	111-24-1	111-24-0
24-28"	±.0006"	600-700mm	±0.016mm	4 pcs	2 pcs	115-28-1	115-28-0	111-28-1	111-28-0
28-32"	±.0007"	700-800mm	±0.018mm	4 pcs	2 pcs	115-32-1	115-32-0	111-32-1	111-32-0
32-36"	±.0008"	800-900mm	±0.020mm	4 pcs	2 pcs	115-36-1	115-36-0	111-36-1	111-36-0
36-40"	±.0008"	900-1000mm	±0.020mm	4 pcs	2 pcs	115-40-1	115-40-0	111-40-1	111-40-0

Dimension

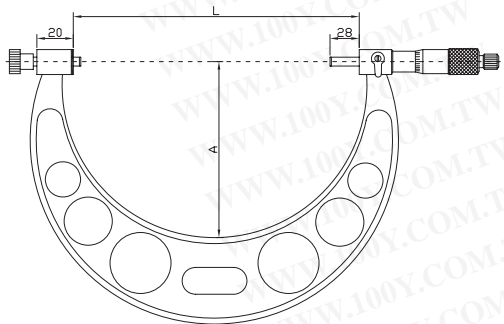

Range	Range	A	L
Inch	Metric	mm	mm
0-6"	0-150mm	82	158
6-12"	150-300mm	165	308
0-4"	0-100mm	57	108
4-8"	100-200mm	114	208
8-12"	200-300mm	165	308
12-16"	300-400mm	224	409
16-20"	400-500mm	275	509
20-24"	500-600mm	321	609
24-28"	600-700mm	371	709
28-32"	700-800mm	426	809
32-36"	800-900mm	476	909
36-40"	900-1000mm	576	1009

Note: The individual anvils are matched as a set with the frame. The accuracy can not be guaranteed if used with a different frame



Indicating Micrometers

152 Series



152-01-0



S-wrench



Standard

FEATURES

- Resolution: Indicator: .00005" / 0.001mm
Scale: .0001" / 0.002mm
- Carbide tipped measuring faces
- Grey painted steel frame
- Indicator range: $\pm 0.04\text{mm}$
- Retractable anvil with an indicator for precision measurement of mass-produced parts

STANDARD ACCESSORIES

- S-wrench, Standard (over 1"/25mm range)
- Warranty card, Instruction manual, Calibration certificate

SPECIFICATIONS

Inch		Metric			
Range	Accuracy	Range	Accuracy	Code No.	Code No.
0-1"	$\pm 0.001"$	0-25mm	$\pm 0.002\text{mm}$	152-01-1	152-01-0
1-2"	$\pm 0.002"$	25-50mm	$\pm 0.002\text{mm}$	152-02-1	152-02-0
2-3"	$\pm 0.002"$	50-75mm	$\pm 0.003\text{mm}$	152-03-1	152-03-0
3-4"	$\pm 0.002"$	75-100mm	$\pm 0.003\text{mm}$	152-04-1	152-04-0

Dimension

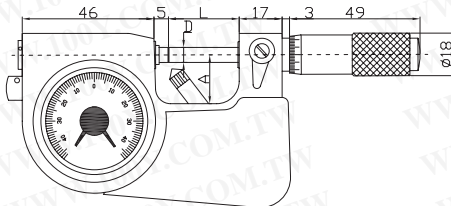

Range	L	A	D
Inch/Metric	mm	mm	mm
0-1"/0-25mm	28.5	19	φ6.5
1-2"/25-50mm	53.5	30	φ6.5
2-3"/50-75mm	78.5	45	φ6.5
3-4"/75-100mm	103.5	57	φ6.5

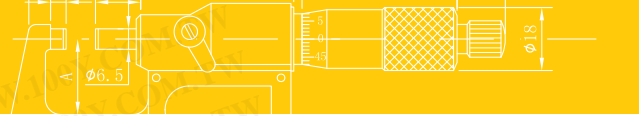

Two and Three Point Internal Micrometers (2-12mm/.08-.5")



208-12-0



209-09-0

FEATURES

- Resolution:
 - Digital models: .00005" / 0.001mm
 - Mechanical models: .0001" / 0.001mm
- Protection level IP65
- Ratchet stop
- Setting Ring supplied
- Measuring contact points are designed to allow measurements near to the bottom of blind holes
- Models Up to and including 6mm or .24 inch have two measuring points and models 7mm or .275 inch and above are with three measuring points

STANDARD ACCESSORIES

- Battery (Digital models),
- Setting Ring,
- Extension Rod (over 6-8mm range),
- S-wrench, Screwdriver
- Warranty card, Instruction manual, Calibration certificate

SPECIFICATIONS

Digital models

Inch			Metric						Inch		Metric	
Range	Accuracy	Setting Ring	Range	Accuracy	Setting Ring	L	A	Extension Rod	Code No.	Code No.		
.08-.1"	±0.0016"	.1"	2-2.5mm	±0.004mm	2.5mm	12.5mm	-	-	208-06-1	208-06-0		
.1-.12"	±0.0016"	.1"	2.5-3mm	±0.004mm	2.5mm	12.5mm	-	-	208-07-1	208-07-0		
.12-.16"	±0.0016"	.16"	3-4mm	±0.004mm	4mm	22.5mm	-	-	208-08-1	208-08-0		
.16-.2"	±0.0016"	.16"	4-5mm	±0.004mm	5mm	22.5mm	-	-	208-09-1	208-09-0		
.2-.24"	±0.0016"	.24"	5-6mm	±0.004mm	6mm	22.5mm	-	-	208-10-1	208-10-0		
.24-.28"	±0.0016"	.24"	-	-	-	22.5mm	0.5mm	-	208-10-5	-		
.275-.35"	±0.0016"	.275"	6-8mm	±0.004mm	6mm	53.5mm	0.5mm	100mm	208-11-1	208-11-0		
.35-.425"	±0.0016"	.35"	8-10mm	±0.004mm	8mm	53.5mm	0.5mm	100mm	208-12-1	208-12-0		
.425-.5"	±0.0016"	.5"	10-12mm	±0.004mm	10mm	53.5mm	0.5mm	100mm	208-13-1	208-13-0		

Mechanical models

Inch			Metric						Inch		Metric	
Range	Accuracy	Setting Ring	Range	Accuracy	Setting Ring	L	A	Extension Rod	Code No.	Code No.		
.08-.1"	±0.0016"	.1"	2-2.5mm	±0.004mm	2.5mm	12.5mm	-	-	209-06-1	209-06-0		
.1-.12"	±0.0016"	.1"	2.5-3mm	±0.004mm	2.5mm	12.5mm	-	-	209-07-1	209-07-0		
.12-.16"	±0.0016"	.16"	3-4mm	±0.004mm	4mm	22.5mm	-	-	209-08-1	209-08-0		
.16-.2"	±0.0016"	.16"	4-5mm	±0.004mm	5mm	22.5mm	-	-	209-09-1	209-09-0		
.2-.24"	±0.0016"	.24"	5-6mm	±0.004mm	6mm	22.5mm	-	-	209-10-1	209-10-0		
.24-.28"	±0.0016"	.24"	-	-	-	22.5mm	0.5mm	-	209-10-5	-		
.275-.35"	±0.0016"	.275"	6-8mm	±0.004mm	6mm	53.5mm	0.5mm	100mm	209-11-1	209-11-0		
.35-.425"	±0.0016"	.35"	8-10mm	±0.004mm	8mm	53.5mm	0.5mm	100mm	209-12-1	209-12-0		
.425-.5"	±0.0016"	.5"	10-12mm	±0.004mm	10mm	53.5mm	0.5mm	100mm	209-13-1	209-13-0		

Dimension: 2-6mm/.08 - .24"



Dimension: 6-12mm/.275 - 0.5"

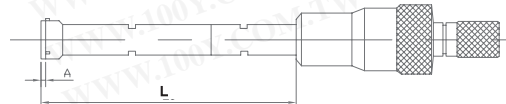



Three-Point Internal Micrometers (12-100mm/.5-4.0")

208 / 209 Series



208-28-0

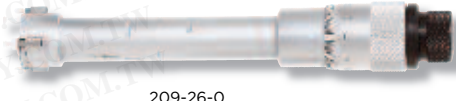

209-26-0

FEATURES

- Resolution:
 - Digital models: .00005" / 0.001mm
 - Mechanical models: .0002" / 0.005mm
- Protection level IP65
- Ratchet stop
- Setting Ring for origin point setting
- Measuring contact points are designed to allow measurements near to the bottom of blind holes
- Additional extensions can be added to increase the measuring depth
- Measuring surfaces are carbide

STANDARD ACCESSORIES

- Battery (Digital models),
- Extension Rod (over 6-8mm range),
- Wrench, Screwdriver, Setting Ring
- Warranty card, Instruction manual, Calibration certificate

SPECIFICATIONS

Digital models

Inch			Metric						Inch		Metric	
Range	Accuracy	Setting Ring	Range	Accuracy	Setting Ring	L1	A	Extension Rod	Code No.	Code No.		
.5-.65"	±0.0016"	.65"	12-16mm	±0.004mm	16mm	80mm	0.5mm	150mm	208-24-1	208-24-0		
.65-.8"	±0.0016"	.65"	16-20mm	±0.004mm	16mm	80mm	0.5mm	150mm	208-25-1	208-25-0		
.8-1"	±0.0016"	1"	20-25mm	±0.004mm	25mm	90mm	0.5mm	150mm	208-26-1	208-26-0		
1-1.2"	±0.0016"	1"	25-30mm	±0.004mm	25mm	90mm	0.5mm	150mm	208-27-1	208-27-0		
1.2-1.6"	±0.0016"	1.6"	30-40mm	±0.004mm	40mm	97mm	0.5mm	150mm	208-28-1	208-28-0		
1.6-2"	±0.0002"	1.6"	40-50mm	±0.005mm	40mm	97mm	0.5mm	150mm	208-29-1	208-29-0		
2-2.5"	±0.0002"	2.5"	50-63mm	±0.005mm	62mm	114mm	0.5mm	150mm	208-30-1	208-30-0		
2.5-3"	±0.0002"	2.5"	62-75mm	±0.005mm	62mm	114mm	0.5mm	150mm	208-31-1	208-31-0		
3-3.5"	±0.0002"	3.5"	75-88mm	±0.005mm	87mm	114mm	0.5mm	150mm	208-32-1	208-32-0		
3.5-4"	±0.0002"	3.5"	87-100mm	±0.005mm	87mm	114mm	0.5mm	150mm	208-33-1	208-33-0		

Mechanical models

Inch			Metric						Inch		Metric	
Range	Accuracy	Setting Ring	Range	Accuracy	Setting Ring	L1	A	Extension Rod	Code No.	Code No.		
.5-.65"	±0.0016"	.65"	12-16mm	±0.004mm	16mm	80mm	0.5mm	150mm	209-24-1	209-24-0		
.65-.8"	±0.0016"	.65"	16-20mm	±0.004mm	16mm	80mm	0.5mm	150mm	209-25-1	209-25-0		
.8-1"	±0.0016"	1"	20-25mm	±0.004mm	25mm	90mm	0.5mm	150mm	209-26-1	209-26-0		
1-1.2"	±0.0016"	1"	25-30mm	±0.004mm	25mm	90mm	0.5mm	150mm	209-27-1	209-27-0		
1.2-1.6"	±0.0016"	1.6"	30-40mm	±0.004mm	40mm	97mm	0.5mm	150mm	209-28-1	209-28-0		
1.6-2"	±0.0002"	1.6"	40-50mm	±0.005mm	40mm	97mm	0.5mm	150mm	209-29-1	209-29-0		
2-2.5"	±0.0002"	2.5"	50-63mm	±0.005mm	62mm	114mm	0.5mm	150mm	209-30-1	209-30-0		
2.5-3"	±0.0002"	2.5"	62-75mm	±0.005mm	62mm	114mm	0.5mm	150mm	209-31-1	209-31-0		
3-3.5"	±0.0002"	3.5"	75-88mm	±0.005mm	87mm	114mm	0.5mm	150mm	209-32-1	209-32-0		
3.5-4"	±0.0002"	3.5"	87-100mm	±0.005mm	87mm	114mm	0.5mm	150mm	209-33-1	209-33-0		

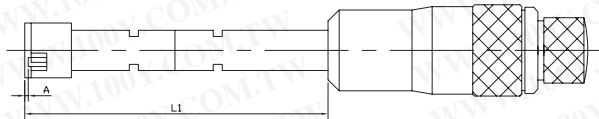

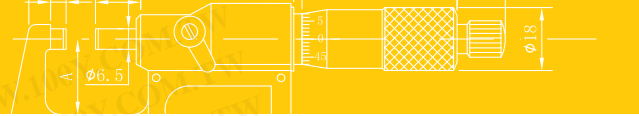

Three-Point Internal Micrometers (100-300mm/4.0-12.0") 208 / 209 Series



208-37-0



209-35-0



209-36-0

FEATURES

- Resolution:
 - Digital models: .00005" / 0.001mm
 - Mechanical models: .0002" / 0.005mm
- Protection level IP65
- Ratchet stop
- Measuring contact points are designed to allow measurements near to the bottom of blind holes
- Additional extensions can be added to increase the measuring depth
- Measuring surfaces are carbide
- Setting Ring are not included with the set but are optional

STANDARD ACCESSORIES

- Battery (Digital models)
- Extension Rod (over 6-8mm range)
- Wrench, Screwdriver
- Warranty card, Instruction manual, Calibration certificate

SPECIFICATIONS

Digital models

Inch			Metric			Optional			
Range	Accuracy	Setting Ring	Range	Accuracy	Setting Ring	L1	Extension Rod	Code No.	Code No.
4-5"	±0.0002"	4.5"	100-125mm	±0.005mm	112.5mm	145mm	150mm	208-34-1	208-34-0
5-6"	±0.0002"	5.5"	125-150mm	±0.005mm	137.5mm	145mm	150mm	208-35-1	208-35-0
6-7"	±0.0002"	6.5"	150-175mm	±0.005mm	162.5mm	145mm	150mm	208-36-1	208-36-0
7-8"	±0.0002"	7.5"	175-200mm	±0.005mm	187.5mm	145mm	150mm	208-37-1	208-37-0
8-9"	±0.00028"	8.5"	200-225mm	±0.007mm	212.5mm	145mm	150mm	208-38-1	208-38-0
9-10"	±0.00028"	9.5"	225-250mm	±0.007mm	237.5mm	145mm	150mm	208-39-1	208-39-0
10-11"	±0.00028"	10.5"	250-275mm	±0.007mm	262.5mm	145mm	150mm	208-40-1	208-40-0
11-12"	±0.00028"	11.5"	275-300mm	±0.007mm	287.5mm	145mm	150mm	208-41-1	208-41-0

Mechanical models

Inch			Metric			optional			
Range	Accuracy	Setting Ring	Range	Accuracy	Setting Ring	L1	Extension Rod	Code No.	Code No.
4-5"	±0.0002"	4.5"	100-125mm	±0.005mm	112.5mm	145mm	150mm	209-34-1	209-34-0
5-6"	±0.0002"	5.5"	125-150mm	±0.005mm	137.5mm	145mm	150mm	209-35-1	209-35-0
6-7"	±0.0002"	6.5"	150-175mm	±0.005mm	162.5mm	145mm	150mm	209-36-1	209-36-0
7-8"	±0.0002"	7.5"	175-200mm	±0.005mm	187.5mm	145mm	150mm	209-37-1	209-37-0
8-9"	±0.00028"	8.5"	200-225mm	±0.007mm	212.5mm	145mm	150mm	209-38-1	209-38-0
9-10"	±0.00028"	9.5"	225-250mm	±0.007mm	237.5mm	145mm	150mm	209-39-1	209-39-0
10-11"	±0.00028"	10.5"	250-275mm	±0.007mm	262.5mm	145mm	150mm	209-40-1	209-40-0
11-12"	±0.00028"	11.5"	275-300mm	±0.007mm	287.5mm	145mm	150mm	209-41-1	209-41-0

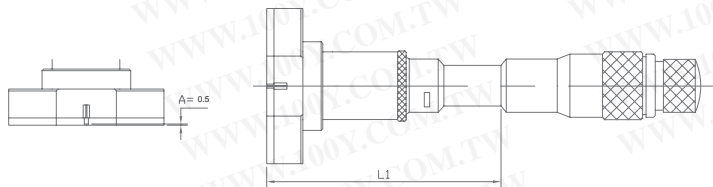

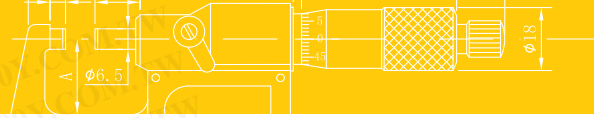

Two and Three Point Internal Micrometers Sets

208 / 209 Series



209-62-8

SPECIFICATIONS

Digital models

Range	Individual range	Setting Ring	Extension Rod	Code No.
Inch				
.08-.12"	0.08-0.1", 0.1-0.12" 2 pcs	0.1"	-	208-61-9
.12-.28"	0.12-0.16", 0.16"-0.2", 0.2-0.24", 0.24-0.28" 4 pcs	0.16", 0.24"	-	208-62-9
.275-.5"	0.275-0.35", 0.35-0.425", 0.425"-0.5" 3 pcs	0.275", 0.35", 0.5"	4"	208-63-9
.5-.8"	0.5-0.65", 0.65-0.8" 2 pcs	0.65"	6"	208-64-9
.8-2"	0.8-1", 1-1.2", 1.2-1.6", 1.6-2" 4 pcs	1", 1.6"	6"	208-65-9
2-4"	2-2.5", 2.5-3", 3-3.5", 3.5-4" 4 pcs	2.5", 3.5"	6"	208-66-9
Metric				
2-3mm	2-2.5, 2.5-3mm 2 pcs	2.5mm	-	208-61-8
3-6mm	3-4, 4-5, 5-6mm 3 pcs	4, 5, 6mm	-	208-62-8
6-12mm	6-8, 8-10, 10-12mm 3 pcs	6, 8, 10mm	100mm	208-63-8
12-20mm	12-16, 16-20mm 2 pcs	16mm	150mm	208-64-8
20-50mm	20-25, 25-30, 30-40, 40-50mm 4 pcs	25, 40mm	150mm	208-65-8
50-100mm	50-63, 62-75, 75-88, 87-100mm 4 pcs	62, 87mm	150mm	208-66-8

Mechanical models

Range	Individual range	Setting Ring	Extension Rod	Code No.
Inch				
.08-.12"	0.08-0.1", 0.1-0.12" 2 pcs	0.1"	-	209-61-9
.12-.28"	0.12-0.16", 0.16"-0.2", 0.2-0.24", 0.24-0.28" 4 pcs	0.16", 0.24"	-	209-62-9
.275-.5"	0.275-0.35", 0.35-0.425", 0.425"-0.5" 3 pcs	0.275", 0.35", 0.5"	4"	209-63-9
.5-.8"	0.5-0.65", 0.65-0.8" 2 pcs	0.65"	6"	209-64-9
.8-2"	0.8-1", 1-1.2", 1.2-1.6", 1.6-2" 4 pcs	1", 1.6"	6"	209-65-9
2-4"	2-2.5", 2.5-3", 3-3.5", 3.5-4" 4 pcs	2.5", 3.5"	6"	209-66-9
Metric				
2-3mm	2-2.5, 2.5-3mm 2 pcs	2.5mm	-	209-61-8
3-6mm	3-4, 4-5, 5-6mm 3 pcs	4, 5, 6mm	-	209-62-8
6-12mm	6-8, 8-10, 10-12mm 3 pcs	6, 8, 10mm	100mm	209-63-8
12-20mm	12-16, 16-20mm 2 pcs	16mm	150mm	209-64-8
20-50mm	20-25, 25-30, 30-40, 40-50mm 4 pcs	25, 40mm	150mm	209-65-8
50-100mm	50-63, 62-75, 75-88, 87-100mm 4 pcs	62, 87mm	150mm	209-66-8

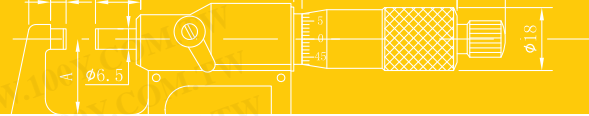

Inside Micrometers

203 / 207 Series

FEATURES

- Resolution:
 - Digital models: .00005" / 0.001mm
 - Mechanical models: .001" / 0.01mm
- Designed for the measurement of intricate internal characteristics
- 207 Series has solid carbide pins for measurement contact points
- Satin chrome finished
- .2-1.2"/5-30mm and 1-2"/25-50mm range are supplied with Setting Ring
- Ratchet stop



207-01-1



203-02-0

STANDARD ACCESSORIES

- Battery (Digital models), S-wrench, Setting Ring
- Warranty card, Instruction manual, Calibration certificate

SPECIFICATIONS

Inch			Metric			Inch		Metric	
Range	Resolution	Accuracy	Range	Resolution	Accuracy	Code No.	Code No.		
Digital models									
.2-1.2"	.00005"	±.0001"	5-30mm	0.001mm	±0.007mm	207-01-1	207-01-0		
1-2"	.00005"	±.0002"	25-50mm	0.001mm	±0.008mm	207-02-1	207-02-0		
2-3"	.00005"	±.0002"	50-75mm	0.001mm	±0.009mm	207-03-1	207-03-0		
3-4"	.00005"	±.0002"	75-100mm	0.001mm	±0.010mm	207-04-1	207-04-0		
4-5"	.00005"	±.0002"	100-125mm	0.001mm	±0.010mm	207-05-1	207-05-0		
5-6"	.00005"	±.0002"	125-150mm	0.001mm	±0.010mm	207-06-1	207-06-0		
6-7"	.00005"	±.0002"	150-175mm	0.001mm	±0.010mm	207-07-1	207-07-0		
7-8"	.00005"	±.0002"	175-200mm	0.001mm	±0.010mm	207-08-1	207-08-0		
Mechanical models									
.2-1.2"	.001"	±.0001"	5-30mm	0.01mm	±0.007mm	203-01-1	203-01-0		
1.0-2.0"	.001"	±.0002"	25-50mm	0.01mm	±0.008mm	203-02-1	203-02-0		
2.0-3.0"	.001"	±.0002"	50-75mm	0.01mm	±0.009mm	203-03-1	203-03-0		
3.0-4.0"	.001"	±.0002"	75-100mm	0.01mm	±0.010mm	203-04-1	203-04-0		
4.0-5.0"	.001"	±.0002"	100-125mm	0.01mm	±0.010mm	203-05-1	203-05-0		
5.0-6.0"	.001"	±.0002"	125-150mm	0.01mm	±0.010mm	203-06-1	203-06-0		
6.0-7.0"	.001"	±.0002"	150-175mm	0.01mm	±0.010mm	203-07-1	203-07-0		
7.0-8.0"	.001"	±.0002"	175-200mm	0.01mm	±0.010mm	203-08-1	203-08-0		

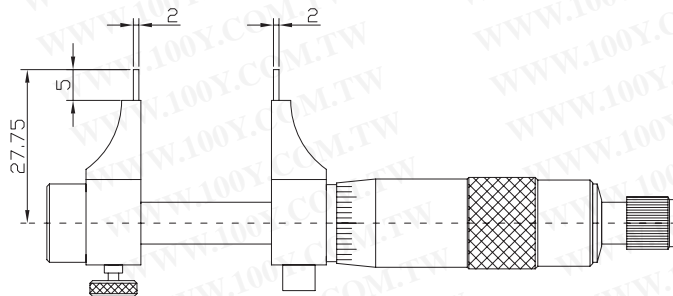



Dual Measurement Inside Micrometers

206 Series

FEATURES

- For all kinds of inside measurement
- Large measuring range with two sides of calipers
- Bi-directional graduation for easy reading in both directions
- Supplied with Setting Ring (Ø1.2"/Ø 30mm dia.)



206-01-0

STANDARD ACCESSORIES

- S-wrench, Setting Ring
- Warranty card, Instruction manual, Calibration certificate

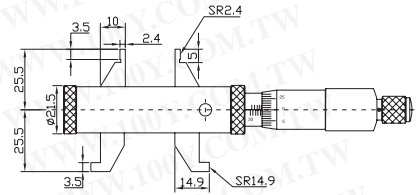

SPECIFICATIONS

Upper Range	Lower Range	Graduation	Accuracy	Code No.
Inch				
.2-1.2"	1.2-2.2"	.001"	±.00024"	206-01-1
Metric				
5-30mm	30-55mm	0.01mm	±0.008mm	206-01-0

Tubular Inside Micrometers

240 Series

SPECIFICATIONS

- Graduation: .001" / 0.01mm
- Offers a wide range of ID measurements by combining extension rods with the micrometer head
- Supplied with a standard caliper gauge for zero setting
- The combining of Extension Rod provides a wide measuring range
- Carbide measuring faces
- Diameter of Extension Rod:Ø15.5mm

STANDARD ACCESSORIES

- S-wrench, Standard caliper gauge, Extension Rod, Micrometer head
- Warranty card, Instruction manual, Calibration certificate

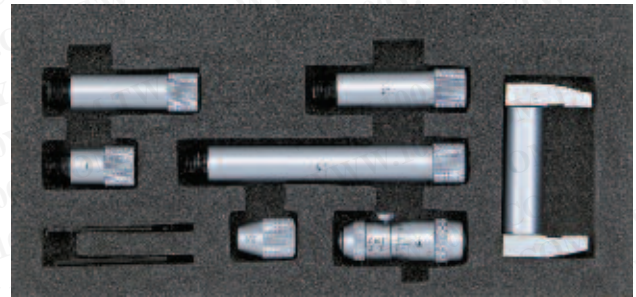

240-01-1

SPECIFICATIONS

Range	Extension Rod	Note	Code No.
Inch			
2-12"	.5",1",2"(2 pcs),4"	Includes .50", .001" Mic. Head	240-01-1
2-40"	.5",1",2",4"(2 pcs),6",8",12"	Includes .50", .001" Mic. Head	240-02-1
2-2.5"	-	Replacement Mic Head .001"	169-55-1
Metric			
50-300mm	13, 25, 50 (2 pcs), 100mm	Includes 13mm, 0.01mm Mic. Head	240-01-0
50-1000mm	13, 25, 50, 100 (2 pcs), 150, 200, 300mm	Includes 13mm, 0.01mm Mic. Head	240-02-0
50-1500mm	13, 25, 50, 100 (2 pcs), 150, 200 (2 pcs), 300mm (2 pcs)	Includes 13mm, 0.01mm Mic. Head	240-03-0
50-100mm	13, 25mm	Includes 13mm, 0.01mm Mic. Head	240-11-0
50-500mm	13, 25, 50 (2 pcs), 100, 200mm	Includes 13mm, 0.01mm Mic. Head	240-12-0
50-63mm	-	Replacement 0.01mm Mic. Head	169-55-0

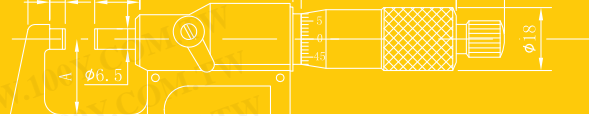

Inside Micrometers - Interchangeable Rod Type

242 Series



242-40-1

FEATURES

- Graduation: .001" / 0.01mm.
- Rods marked with its measuring range
- Satin chrome finish throughout
- All contact points hardened for extra long tool life
- With locking clamp
- Zero point can be readjusted by rotating the micrometer head sleeve
- Carbide tipped measuring faces

STANDARD ACCESSORIES

- Micrometer head, Extension Rod, S-wrench
- Warranty card, Instruction manual, Calibration certificate

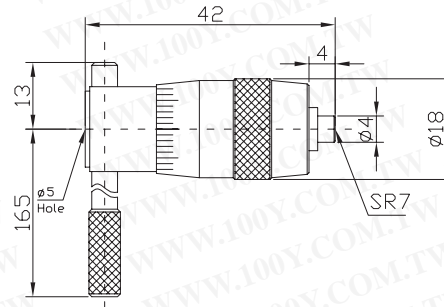

SPECIFICATIONS

Range	Head Travel	Graduation	Spacing Collar	Diameter of Rods	Note	Code No.
Inch						
1-2"	.25"	.001"	.250"	Φ.248"	1" Mic head & 2 Rods	242-02-1
2-8"	.50"	.001"	.500"	Φ.248"	2" Mic head & 6 Rods	242-08-1
2-12"	.50"	.001"	.500"	Φ.248"	2" Mic head & 10 Rods	242-12-1
8-20"	1.00"	.001"	1", 2"	Φ.355"	8" Mic head & 3 Rods	242-20-1
8-40"	1.00"	.001"	1", 2"	Φ.355"	8" Mic head & 8 Rods	242-40-1
Metric						
25-50mm	7.0mm	0.01mm	6.0mm	Φ6.3mm	25mm Mic head & 2 Rods	242-02-0
50-200mm	13mm	0.01mm	12.0mm	Φ6.3mm	50mm Mic head & 6 Rods	242-08-0
50-300mm	13mm	0.01mm	12.0mm	Φ6.3mm	50mm Mic head & 10 Rods	242-12-0
200-500mm	25mm	0.01mm	25mm, 50mm	Φ9mm	200mm Mic head & 3 Rods	242-20-0
200-1000mm	25mm	0.01mm	25mm, 50mm	Φ9mm	200mm Mic head & 8 Rods	242-40-0

Note: Individual rods are matched with micrometer and should not be interchanged with other sets

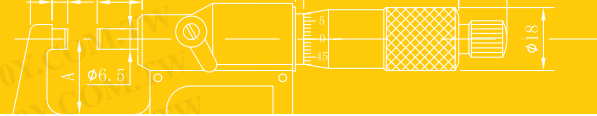

Quick-Setting Outside Micrometers, 1mm Rev

102 Series

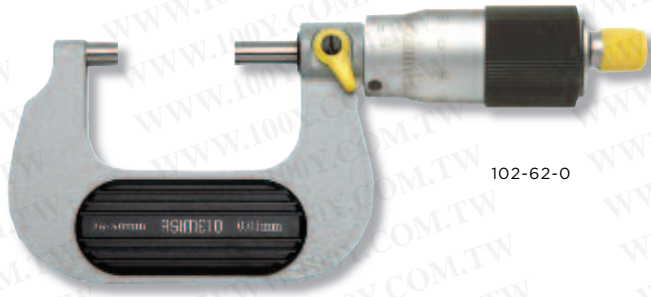

102-62-0

S-wrench



Standard



FEATURES

- Graduation: 0.01mm
- Flatness: 0.3μm
- 1mm thread pitch for quick setting
- The measurement can be read directly from the thimble due to the 100 step graduation
- Carbide tipped measuring faces
- Ratchet thimble
- Grey painted steel frame

SPECIFICATIONS

Range	Accuracy	Code No.
0-25mm	±0.004mm	102-61-0
25-50mm	±0.004mm	102-62-0
50-75mm	±0.005mm	102-63-0
75-100mm	±0.005mm	102-64-0

Range	A	B	L
0-25mm	6mm	24mm	32mm
25-50mm	8mm	32mm	57mm
50-75mm	8mm	45mm	82mm
75-100mm	8mm	57mm	107mm

STANDARD ACCESSORIES

- S-wrench, Standard (over 25mm range)
- Warranty card, Instruction manual, Calibration certificate

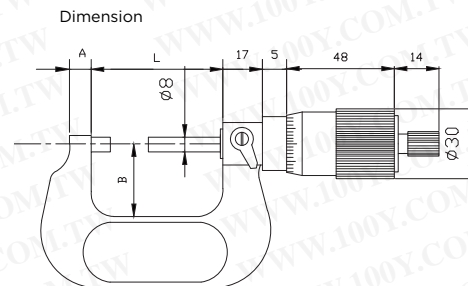

Micrometer Stands

109 Series

- These stands are designed to allow bench top use with hand micrometers



Code No.: 109-01-0
Painted Steel Base



Code No.: 109-02-1
Painted Cast-iron Base



Blade Micrometers

112 / 117 Series



117-01-1



112-01-0



S-wrench



Battery



Standard

STANDARD ACCESSORIES

- S-wrench, Battery (Digital models), Standard (over 1"/25mm range)
- Warranty card, Instruction manual, Calibration certificate

FEATURES

- Resolution: Digital reading: .00005" / 0.001mm Scale on digital models: .0001" / 0.01mm Scale on mechanical models: .001" / 0.01mm
- Ratchet stop
- For measuring the groove diameter of shafts, keyways, and other hard to reach portions
- Non-rotating spindle
- Carbide tipped measuring faces
- Grey painted steel frame
- Inch/Metric conversion
- Upon switching on the display will read the actual absolute measuring position
- Automatic On/Off to maximize battery life
- Absolute or incremental measuring modes

SPECIFICATIONS

Digital models

Inch	Metric	Inch	Metric	Anvil Type	Inch	Metric
Range	Accuracy	Range	Accuracy		Code No.	Code No.
0-1"	±0.0001"	0-25mm	±0.003mm	A	117-01-1	117-01-0
1-2"	±0.0002"	25-50mm	±0.003mm	A	117-02-1	117-02-0
2-3"	±0.0002"	50-75mm	±0.003mm	A	117-03-1	117-03-0
3-4"	±0.0002"	75-100mm	±0.004mm	A	117-04-1	117-04-0
4-5"	±0.0002"	100-125mm	±0.004mm	A	117-05-1	117-05-0
5-6"	±0.0002"	125-150mm	±0.004mm	A	117-06-1	117-06-0
0-1"	±0.0001"	0-25mm	±0.003mm	B	117-01-3	117-01-2
1-2"	±0.0002"	25-50mm	±0.003mm	B	117-02-3	117-02-2
2-3"	±0.0002"	50-75mm	±0.003mm	B	117-03-3	117-03-2
3-4"	±0.0002"	75-100mm	±0.004mm	B	117-04-3	117-04-2
4-5"	±0.0002"	100-125mm	±0.004mm	B	117-05-3	117-05-2

Mechanical models

Inch	Metric	Inch	Metric	Anvil Type	Inch	Metric
Range	Accuracy	Range	Accuracy		Code No.	Code No.
0-1"	±0.0001"	0-25mm	±0.004mm	A	112-01-1	112-01-0
1-2"	±0.0002"	25-50mm	±0.004mm	A	112-02-1	112-02-0
2-3"	±0.0002"	50-75mm	±0.005mm	A	112-03-1	112-03-0
3-4"	±0.0002"	75-100mm	±0.005mm	A	112-04-1	112-04-0
4-5"	±0.0002"	100-125mm	±0.006mm	A	112-05-1	112-05-0
5-6"	±0.0002"	125-150mm	±0.006mm	A	112-06-1	112-06-0
0-1"	±0.0001"	0-25mm	±0.004mm	B	112-01-3	112-01-2
1-2"	±0.0002"	25-50mm	±0.004mm	B	112-02-3	112-02-2
2-3"	±0.0002"	50-75mm	±0.005mm	B	112-03-3	112-03-2
3-4"	±0.0002"	75-100mm	±0.005mm	B	112-04-3	112-04-2
4-5"	±0.0002"	100-125mm	±0.006mm	B	112-05-3	112-05-2

Dimension

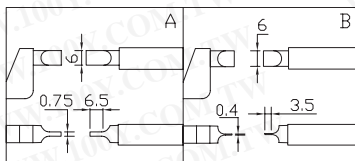
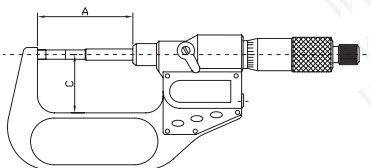

Range	A	C
Inch/Metric	mm	mm
0-1"/0-25mm	57	32
1-2"/25-50mm	82	44.5
2-3"/50-75mm	107	57
3-4"/75-100mm	132.6	69.5

Multi-Anvil Micrometers

121 / 125 Series



125-01-1

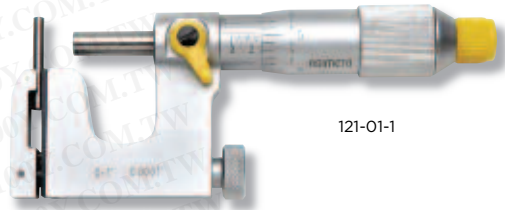

121-01-1

STANDARD ACCESSORIES

- Battery (Digital models), Rod Anvil, Flat Anvil
- S-wrench, Standard (25-50mm)
- Warranty card, Instruction manual, Calibration certificate



S-wrench



wrench



Battery



Standard



Anvils

FEATURES

- Resolution:
 - Digital reading: .00005" / 0.001mm
 - Scale on digital models: .0001" / 0.01mm
 - Scale on mechanical models: .0001" / 0.01mm
- Ratchet stop for digital models
- Ratchet thimble for mechanical models
- Measures tube thickness, shoulder edge distance
- Measures rivet head height, with interchangeable anvils (Flat Anvil, Rod Anvil, V-anvil)
- Carbide tipped measuring faces
- Chrome-plated steel feet frame
- Inch/Metric conversion
- Upon switching on the display will read the actual absolute measuring position
- Automatic On/Off to maximize battery life
- Absolute or incremental measuring modes
- Protection level IP65

SPECIFICATIONS

Digital models

Inch	Metric	Inch	Metric
Range	Accuracy	Range	Accuracy
0-1"	±.0001"	0-25mm	±0.002mm
1-2"	±.0002"	25-50mm	±0.002mm
		Code No.	Code No.
		125-01-1	125-01-0
		125-02-1	125-02-0

Mechanical models

Inch	Metric	Inch	Metric
Range	Accuracy	Range	Accuracy
0-1"	±.0001"	0-25	±0.004
1-2"	±.0002"	25-50	±0.004
		Code No.	Code No.
		121-01-1	121-01-0
		121-02-1	121-02-0

Dimension

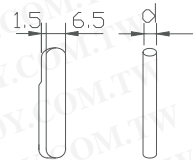
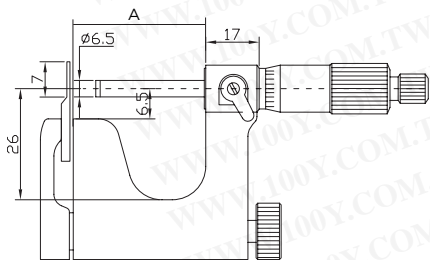

Range	A	d
0-25mm	28.5mm	3mm
25-50mm	53.5mm	5mm



Point Micrometers

122 / 126 Series



126-02-1



122-01-1



S-wrench



Battery



Standard

FEATURES

- Resolution:
 - Digital reading: .00005" / 0.001mm
 - Scale on digital models: .0001" / 0.01mm
 - Scale on mechanical models: .001" / 0.01mm
- 15 degree and 30 degree measuring points are available
- For measuring the web thickness of drills, small grooves, and other hard to reach dimensions
- Carbide tipped measuring faces
- Grey painted steel frame
- Ratchet stop

STANDARD ACCESSORIES

- S-wrench, Battery (Digital models), Standard (over 1"/25mm range)
- Warranty card, Instruction manual, Calibration certificate
- Inch/Metric conversion
- Upon switching on the display will read the actual absolute measuring position
- Automatic On/Off to maximize battery life
- Absolute or incremental measuring modes
- Protection level IP65

SPECIFICATIONS

Digital models

Inch		Metric			Inch		Metric	
Range	Accuracy	Range	Accuracy	Anvil Type	Code No.	Code No.		
0-1"	±.0001"	0-25mm	±0.002mm	15°	126-01-1	126-01-0		
1-2"	±.0002"	25-50mm	±0.002mm	15°	126-02-1	126-02-0		
2-3"	±.0002"	50-75mm	±0.003mm	15°	126-03-1	126-03-0		
3-4"	±.0002"	75-100mm	±0.003mm	15°	126-04-1	126-04-0		
0-1"	±.0001"	0-25mm	±0.002mm	30°	126-01-3	126-01-2		
1-2"	±.0002"	25-50mm	±0.002mm	30°	126-02-3	126-02-2		
2-3"	±.0002"	50-75mm	±0.003mm	30°	126-03-3	126-03-2		
3-4"	±.0002"	75-100mm	±0.003mm	30°	126-04-3	126-04-2		

Mechanical models

Inch		Metric			Inch		Metric	
Range	Accuracy	Range	Accuracy	Anvil Type	Code No.	Code No.		
0-1"	±.0001"	0-25mm	±0.004mm	15°	122-01-1	122-01-0		
1-2"	±.0002"	25-50mm	±0.004mm	15°	122-02-1	122-02-0		
2-3"	±.0002"	50-75mm	±0.005mm	15°	122-03-1	122-03-0		
3-4"	±.0002"	75-100mm	±0.005mm	15°	122-04-1	122-04-0		
0-1"	±.0001"	0-25mm	±0.004mm	30°	122-01-3	122-01-2		
1-2"	±.0002"	25-50mm	±0.004mm	30°	122-02-3	122-02-2		
2-3"	±.0002"	50-75mm	±0.005mm	30°	122-03-3	122-03-2		
3-4"	±.0002"	75-100mm	±0.005mm	30°	122-04-3	122-04-2		

Dimension

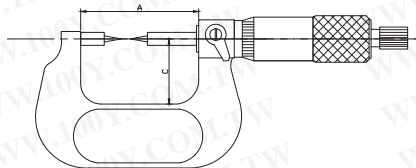
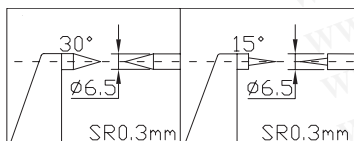

Range	Range	A	C
Inch	Metric	mm	mm
0-1"	0-25mm	57	32
1-2"	25-50mm	82	44.5
2-3"	50-75mm	107	57
3-4"	75-100mm	132.6	69.5



Single Point Micrometers

131 / 135 Series



135-01-3



S-wrench



Battery



Standard



131-01-3

STANDARD ACCESSORIES

- S-wrench, Battery (Digital models), Standard (over 1"/25mm range)
- Warranty card, Instruction manual, Calibration certificate,
- Inch/Metric conversion
- Upon switching on the display will read the actual absolute measuring position
- Automatic On/Off to maximize battery life
- Absolute or incremental measuring modes

FEATURES

- Resolution:
 - Digital reading: .00005" / 0.001mm
 - Scale on digital models: .0001" / 0.01mm
 - Scale on mechanical models: .0001" / 0.01mm
- Protection level IP65
- For measuring the height of crimp contacts
- Carbide tipped measuring faces
- Grey painted steel frame
- Ratchet stop

SPECIFICATIONS

Digital models

Inch		Metric		Anvil Type	Code No.	
Range	Accuracy	Range	Accuracy		Inch	Metric
0-1"	±.0001"	0-25mm	±0.002mm	B	135-01-1	135-01-0
1-2"	±.0002"	25-50mm	±0.002mm	B	135-02-1	135-02-0
2-3"	±.0002"	50-75mm	±0.003mm	B	135-03-1	135-03-0
3-4"	±.0002"	75-100mm	±0.003mm	B	135-04-1	135-04-0
0-1"	±.0001"	0-25mm	±0.002mm	C	135-01-3	135-01-2
0-1"	±.0001"	0-25mm	±0.002mm	E	135-01-5	135-01-4

Mechanical models

Inch		Metric		Anvil Type	Code No.	
Range	Accuracy	Range	Accuracy		Inch	Metric
0-1"	±.0001"	0-25mm	±0.004mm	B	131-01-1	131-01-0
1-2"	±.0002"	25-50mm	±0.004mm	B	131-02-1	131-02-0
2-3"	±.0002"	50-75mm	±0.005mm	B	131-03-1	131-03-0
3-4"	±.0002"	75-100mm	±0.005mm	B	131-04-1	131-04-0
0-1"	±.0001"	0-25mm	±0.004mm	C	131-01-3	131-01-2
0-1"	±.0001"	0-25mm	±0.004mm	E	131-01-5	131-01-4

Dimension

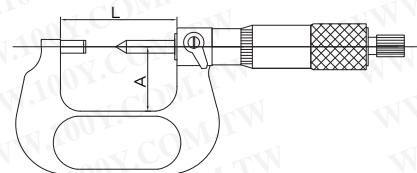
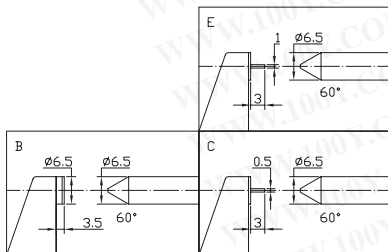

Range	Range	L	A
Inch	Metric	mm	mm
0-1"	0-25mm	34.4	24
1-2"	25-50mm	59.4	32
2-3"	50-75mm	84.8	44.5
3-4"	75-100mm	110.2	57



Spline Micrometers

118 Series



118-02-1



S-wrench



Battery



Standard



118-61-1

STANDARD ACCESSORIES

- S-wrench, Battery (Digital models), Standard (over 1"/25mm range)
- Warranty card, Instruction manual, Calibration certificate

FEATURES

- Resolution: Digital: .00005" / 0.001mm
Scale on digital models: .0001" / 0.01mm
Scale on mechanical models: .0001" / 0.01mm
- Protection level IP65
- For measuring spline shafts, slots and keyways
- Carbide tipped measuring faces
- Grey painted steel frame
- Ratchet stop
- Anvils A and Anvils B are optional
- Inch/Metric conversion
- Upon switching on the display will read the actual absolute measuring position
- Automatic On/Off to maximize battery life
- Absolute or incremental measuring modes

SPECIFICATIONS

Digital models

Inch		Metric		Anvil Type	Code No.	
Range	Accuracy	Range	Accuracy		Inch	Metric
0-1"	±.0001"	0-25mm	±0.002mm	A (Φ2*5)	118-01-1	118-01-0
1-2"	±.0002"	25-50mm	±0.002mm	A (Φ2*5)	118-02-1	118-02-0
2-3"	±.0002"	50-75mm	±0.003mm	A (Φ2*5)	118-03-1	118-03-0
3-4"	±.0002"	75-100mm	±0.003mm	A (Φ2*5)	118-04-1	118-04-0
4-5"	±.0002"	100-125mm	±0.004mm	A (Φ2*5)	118-05-1	118-05-0
5-6"	±.0002"	125-150mm	±0.004mm	A (Φ2*5)	118-06-1	118-06-0
0-1"	±.0001"	0-25mm	±0.002mm	B (Φ3*10)	118-01-3	118-01-2
1-2"	±.0002"	25-50mm	±0.002mm	B (Φ3*10)	118-02-3	118-02-2
2-3"	±.0002"	50-75mm	±0.003mm	B (Φ3*10)	118-03-3	118-03-2
3-4"	±.0002"	75-100mm	±0.003mm	B (Φ3*10)	118-04-3	118-04-2
4-5"	±.0002"	100-125mm	±0.004mm	B (Φ3*10)	118-05-3	118-05-2
5-6"	±.0002"	125-150mm	±0.004mm	B (Φ3*10)	118-06-3	118-06-2

Mechanical models

Inch		Metric		Anvil Type	Code No.	
Range	Accuracy	Range	Accuracy		Inch	Metric
0-1"	±.0001"	0-25mm	±0.004mm	A (Φ2*5)	118-61-1	118-61-0
1-2"	±.0002"	25-50mm	±0.004mm	A (Φ2*5)	118-62-1	118-62-0
2-3"	±.0002"	50-75mm	±0.005mm	A (Φ2*5)	118-63-1	118-63-0
3-4"	±.0002"	75-100mm	±0.005mm	A (Φ2*5)	118-64-1	118-64-0
4-5"	±.0002"	100-125mm	±0.006mm	A (Φ2*5)	118-65-1	118-65-0
5-6"	±.0002"	125-150mm	±0.006mm	A (Φ2*5)	118-66-1	118-66-0
0-1"	±.0001"	0-25mm	±0.004mm	B (Φ3*10)	118-61-3	118-61-2
1-2"	±.0002"	25-50mm	±0.004mm	B (Φ3*10)	118-62-3	118-62-2
2-3"	±.0002"	50-75mm	±0.005mm	B (Φ3*10)	118-63-3	118-63-2
3-4"	±.0002"	75-100mm	±0.005mm	B (Φ3*10)	118-64-3	118-64-2
4-5"	±.0002"	100-125mm	±0.006mm	B (Φ3*10)	118-65-3	118-65-2
5-6"	±.0002"	125-150mm	±0.006mm	B (Φ3*10)	118-66-3	118-66-2

Dimension

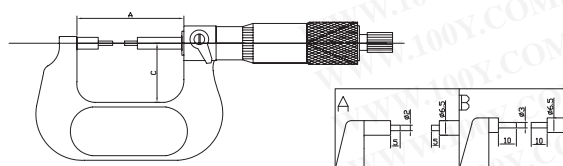

Range		Range		A		C	
Inch	Metric	mm	mm	mm	mm	mm	mm
0-1"	0-25mm	57	32				
1-2"	25-50mm	82	44.5				
2-3"	50-75mm	107	57				
3-4"	75-100mm	132.6	69.5				

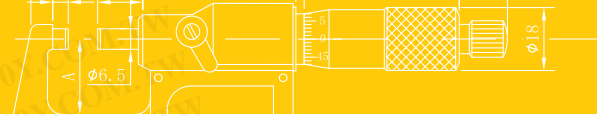

Gear Tooth Micrometers

118 Series



118-31-9



S-wrench



Battery



Standard



118-71-9

STANDARD ACCESSORIES

- S-wrench, Battery (Digital models), Anvils 10 pairs (Set), Standard (over 1"/25mm range)
- Warranty card, Instruction manual, Calibration certificate
- Inch/Metric conversion
- Upon switching on the display will read the actual absolute measuring position
- Automatic On/Off to maximize battery life
- Absolute or incremental measuring modes
- Protection level IP65

FEATURES

- Resolution:
 - Digital reading: .00005" / 0.001mm
 - Scale on digital models: .0001" / 0.01mm
 - Scale on mechanical models: .001" / 0.01mm
- Ratchet stop
- Grey painted steel frame
- Measures over-pin diameter of gears with precision steel (carbide) ball-tipped measuring faces
- Interchangeable ball anvil-spindle tips for various gear modules (0.6-3.5) are optional
- Set includes 10 pairs Interchangeable anvils

SPECIFICATIONS

Digital models

Inch		Metric		Inch		Metric	
Range	Accuracy	Range	Accuracy	Code No.	Set Code No.	Code No.	Set Code No.
0-1"	±.0001"	0-25mm	±0.004mm	118-31-1	118-31-9	118-31-0	118-31-8
1-2"	±.0002"	25-50mm	±0.004mm	118-32-1	118-32-9	118-32-0	118-32-8
2-3"	±.0002"	50-75mm	±0.005mm	118-33-1	118-33-9	118-33-0	118-33-8
3-4"	±.0002"	75-100mm	±0.005mm	118-34-1	118-34-9	118-34-0	118-34-8
4-5"	±.0002"	100-125mm	±0.006mm	118-35-1	118-35-9	118-35-0	118-35-8
5-6"	±.0002"	125-150mm	±0.006mm	118-36-1	118-36-9	118-36-0	118-36-8
6-7"	±.0002"	150-175mm	±0.007mm	118-37-1	118-37-9	118-37-0	118-37-8

Mechanical models

Inch		Metric		Inch		Metric	
Range	Accuracy	Range	Accuracy	Code No.	Set Code No.	Code No.	Set Code No.
0-1"	±.0001"	0-25mm	±0.004mm	118-71-1	118-71-9	118-71-0	118-71-8
1-2"	±.0002"	25-50mm	±0.004mm	118-72-1	118-72-9	118-72-0	118-72-8
2-3"	±.0002"	50-75mm	±0.005mm	118-73-1	118-73-9	118-73-0	118-73-8
3-4"	±.0002"	75-100mm	±0.005mm	118-74-1	118-74-9	118-74-0	118-74-8
4-5"	±.0002"	100-125mm	±0.006mm	118-75-1	118-75-9	118-75-0	118-75-8
5-6"	±.0002"	125-150mm	±0.006mm	118-76-1	118-76-9	118-76-0	118-76-8
6-7"	±.0002"	150-175mm	±0.007mm	118-77-1	118-77-9	118-77-0	118-77-8

Dimension

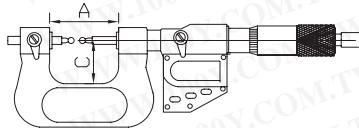

Range	Range	A	C
Inch	Metric	mm	mm
0-1"	0-25mm	67	38
1-2"	25-50mm	92.4	50
2-3"	50-75mm	117.6	62
3-4"	75-100mm	143	70
4-5"	100-125mm	168.2	82
5-6"	125-150mm	192	94.5
6-7"	150-175mm	217	107

Anvils

Ball dia.	Module	Diametral pitch	Code No.
Ø1mm-Ø6.0mm	0.6-3.5	45-7	119-80-0
Ø1mm	0.6-0.65	45	119-81-0
Ø1.5mm	0.9-1.0	28-26	119-82-0
Ø2.0mm	1.25	22	119-83-0
Ø2.5mm	1.5	17	119-84-0
Ø3.0mm	1.75	15	119-85-0
Ø3.5mm	2	13	119-86-0
Ø4.0mm	2.25	11	119-87-0
Ø4.5mm	2.5	10	119-88-0
Ø5.0mm	2.75	9	119-89-0
Ø6.0mm	3.5	7	119-90-0



Screw Thread Micrometers

136 / 137 / 132 / 133 Series

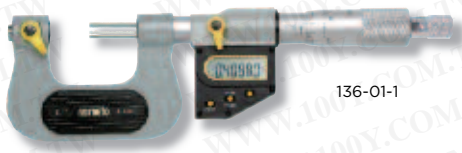

136-01-1



S-wrench



Battery



Standard

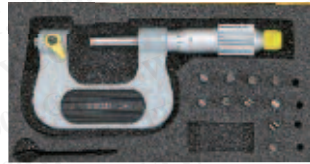

133-01-1

FEATURES

- Resolution:
 - Digital reading: .00005" / 0.001mm
 - Scale on digital models: .0001" / 0.01mm
 - Scale on mechanical models: .001" / 0.01mm
- Grey painted steel frame
- For measuring various screw threads
- Non-rotating spindle
- Ratchet stop for digital models
- Ratchet thimble for Mechanical models
- Set includes 5 pairs Interchangeable anvils

STANDARD ACCESSORIES

- S-wrench, Battery (Digital models), Anvils 5 pairs (Set), Standard (over 1"/25mm range)
- Warranty card, Instruction manual, Calibration certificate
- Inch/Metric conversion
- Upon switching on the display will read the actual absolute measuring position
- Automatic On/Off to maximize battery life
- Absolute or incremental measuring modes
- Protection level IP65

SPECIFICATIONS

Digital models

Inch		Metric		Inch		Metric	
Range	Accuracy	Range	Accuracy	Code No.	Set Code No.	Code No.	Set Code No.
0-1"	±0.001"	0-25mm	±0.004mm	136-01-1	137-01-1	136-01-0	137-01-0
1-2"	±0.002"	25-50mm	±0.004mm	136-02-1	137-02-1	136-02-0	137-02-0
2-3"	±0.002"	50-75mm	±0.005mm	136-03-1	137-03-1	136-03-0	137-03-0
3-4"	±0.002"	75-100mm	±0.005mm	136-04-1	137-04-1	136-04-0	137-04-0
4-5"	±0.002"	100-125mm	±0.006mm	136-05-1	137-05-1	136-05-0	137-05-0
5-6"	±0.002"	125-150mm	±0.006mm	136-06-1	137-06-1	136-06-0	137-06-0

Mechanical models

Inch		Metric		Inch		Metric	
Range	Accuracy	Range	Accuracy	Code No.	Set Code No.	Code No.	Set Code No.
0-1"	±0.001"	0-25mm	±0.004mm	132-01-1	133-01-1	132-01-0	133-01-0
1-2"	±0.002"	25-50mm	±0.004mm	132-02-1	133-02-1	132-02-0	133-02-0
2-3"	±0.002"	50-75mm	±0.005mm	132-03-1	133-03-1	132-03-0	133-03-0
3-4"	±0.002"	75-100mm	±0.005mm	132-04-1	133-04-1	132-04-0	133-04-0
4-5"	±0.002"	100-125mm	±0.006mm	132-05-1	133-05-1	132-05-0	133-05-0
5-6"	±0.002"	125-150mm	±0.006mm	132-06-1	133-06-1	132-06-0	133-06-0

Anvils (For screw 60° ISO)



130-60-0

Pitch	Notes	Code No.
0.4-7.0mm/64-3.5TPI	Set of 6	130-60-0
0.4-0.5mm/64-48TPI	1 Set	130-61-0
0.6-0.9mm/44-28TPI	1 Set	130-62-0
1.0-1.75mm/24-14TPI	1 Set	130-63-0
2.0-3.0mm/13-9TPI	1 Set	130-64-0
3.5-5.0mm/8-5TPI	1 Set	130-65-0
5.5-7.0mm/4.5-3.5TPI	1 Set	130-66-0

Dimension

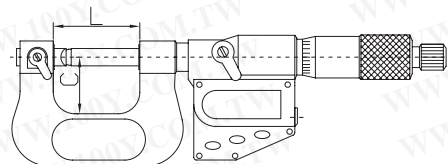

Range	L	C
Inch/Metric	mm	mm
0-1"/0-25mm	42	26
1-2"/25-50mm	67	38
2-3"/50-75mm	92	50
3-4"/75-100mm	117.6	62
4-5"/100-125mm	143	70
5-6"/125-150mm	168.2	82

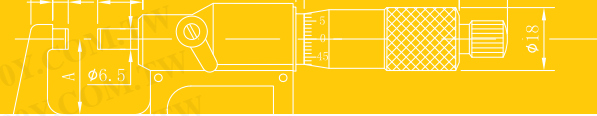

Disc Micrometers

141 / 145 Series



145-02-1



S-wrench



Battery



Standard



141-03-1

STANDARD ACCESSORIES

- S-wrench, Battery (Digital models), Standard (over 1"/25mm range)
- Warranty card, Instruction manual, Calibration certificate
- Inch/Metric conversion
- Upon switching on the display will read the actual absolute measuring position
- Automatic On/Off to maximize battery life
- Absolute or incremental measuring modes

FEATURES

- Resolution:
 - Digital: .00005" / 0.001mm
 - Scale on digital models: .0001" / 0.01mm
 - Scale on mechanical models: .0001" / 0.01mm
- For measuring gears and paper thickness
- Non rotating spindle for digital models
- Grey painted steel frame
- Ratchet stop

SPECIFICATIONS

Digital models

Inch		Metric		Inch	Metric
Range	Accuracy	Range	Accuracy	Code No.	Code No.
0-1"	±.0001"	0-25mm	±0.005mm	145-01-1	145-01-0
1-2"	±.0002"	25-50mm	±0.005mm	145-02-1	145-02-0
2-3"	±.0002"	50-75mm	±0.006mm	145-03-1	145-03-0
3-4"	±.0002"	75-100mm	±0.006mm	145-04-1	145-04-0
4-5"	±.0002"	100-125mm	±0.007mm	145-05-1	145-05-0
5-6"	±.0002"	125-150mm	±0.007mm	145-06-1	145-06-0
6-7"	±.0002"	150-175mm	±0.008mm	145-07-1	145-07-0
7-8"	±.0002"	175-200mm	±0.008mm	145-08-1	145-08-0

Mechanical models

Inch		Metric		Inch code No.	Metric code No.
Range	Accuracy	Range	Accuracy	Non-rotating spindle	Non-rotating spindle
0-1"	±.0001"	0-25mm	±0.005mm	141-01-3	141-01-2
1-2"	±.0002"	25-50mm	±0.005mm	141-02-3	141-02-2
2-3"	±.0002"	50-75mm	±0.006mm	141-03-3	141-03-2
3-4"	±.0002"	75-100mm	±0.006mm	141-04-3	141-04-2
4-5"	±.0002"	100-125mm	±0.007mm	141-05-3	141-05-2
5-6"	±.0002"	125-150mm	±0.007mm	141-06-3	141-06-2
6-7"	±.0002"	150-175mm	±0.008mm	141-07-3	141-07-2
7-8"	±.0002"	175-200mm	±0.008mm	141-08-3	141-08-2

Dimension

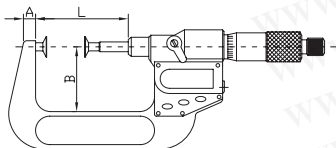
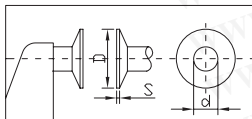

Range	A	B	L	D	S	d
Inch/Metric	mm	mm	mm	mm	mm	mm
0-1"/0-25mm	8	32	43	20	0.7	8
1-2"/25-50mm	8	44.5	68	20	0.7	8
2-3"/50-75mm	8	57	93	20	0.7	8
3-4"/75-100mm	10	70	118.5	20	0.7	8
4-5"/100-125mm	10	82	144	30	0.9	12
5-6"/125-150mm	12	94.5	169.5	30	0.9	12
6-7"/150-175mm	12	107	194.8	30	0.9	12

Jaw Type Micrometers

122 / 126 Series



126-52-1



122-51-1



S-wrench



Battery



Standard

FEATURES

- Resolution:
 - Digital reading: .00005" / 0.001mm
 - Scale on digital models: .0001" / 0.01mm
 - Scale on mechanical models: .0001" / 0.01mm
- For measuring gears and step thickness
- Non-rotating spindle
- Jaw type measuring faces
- Grey painted steel frame
- Ratchet stop
- Inch/Metric conversion
- Upon switching on the display will read the actual absolute measuring position
- Automatic On/Off to maximize battery life
- Absolute or incremental measuring modes

SPECIFICATIONS

Digital models

Inch	Metric	Inch	Metric	Inch	Metric
Range	Accuracy	Range	Accuracy	Code No.	Code No.
0-1"	±.0001"	0-25mm	±0.004mm	126-51-1	126-51-0
1-2"	±.0002"	25-50mm	±0.004mm	126-52-1	126-52-0
2-3"	±.0002"	50-75mm	±0.005mm	126-53-1	126-53-0
3-4"	±.0002"	75-100mm	±0.005mm	126-54-1	126-54-0
4-5"	±.0002"	100-125mm	±0.006mm	126-55-1	126-55-0
5-6"	±.0002"	125-150mm	±0.006mm	126-56-1	126-56-0
6-7"	±.0002"	150-175mm	±0.007mm	126-57-1	126-57-0
7-8"	±.0002"	175-200mm	±0.007mm	126-58-1	126-58-0

Mechanical models

Inch	Metric	Inch	Metric	Inch	Metric
Range	Accuracy	Range	Accuracy	Code No.	Code No.
0-1"	±.0001"	0-25mm	±0.004mm	122-51-1	122-51-0
1-2"	±.0002"	25-50mm	±0.004mm	122-52-1	122-52-0
2-3"	±.0002"	50-75mm	±0.005mm	122-53-1	122-53-0
3-4"	±.0002"	75-100mm	±0.005mm	122-54-1	122-54-0
4-5"	±.0002"	100-125mm	±0.006mm	122-55-1	122-55-0
5-6"	±.0002"	125-150mm	±0.006mm	122-56-1	122-56-0
6-7"	±.0003"	150-175mm	±0.007mm	122-57-1	122-57-0
7-8"	±.0003"	175-200mm	±0.007mm	122-58-1	122-58-0

Dimension

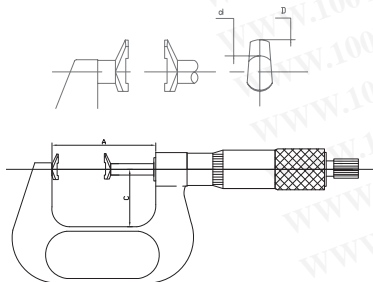

Range	A	C	D	d
Inch/Metric	mm	mm	mm	mm
0-1"/0-25mm	34.4	24	R10	Φ8
1-2"/25-50mm	59.4	32	R10	Φ8
2-3"/50-75mm	84.8	44.5	R10	Φ8
3-4"/75-100mm	110.2	57	R10	Φ8
4-5"/100-125mm	137.6	69.5	R15	Φ12
5-6"/125-150mm	163	82	R15	Φ12
6-7"/150-175mm	188.4	94.5	R15	Φ12
7-8"/175-200mm	213.8	107	R15	Φ12

Universal Micrometers

142 / 146 Series



146-01-0



S-wrench



Battery



Standard



Anvils



142-01-1

STANDARD ACCESSORIES

- S-wrench, Battery (Digital models), 7 pairs Anvils, Standard (over 1"/25mm range)
- Warranty card, Instruction manual, Calibration certificate

FEATURES

- Resolution: Digital reading: .00005" / 0.001mm Scale on digital models: .0001" / 0.01mm Scale on mechanical models: .001" / 0.01mm
- Protection level IP65
- With 7 pairs of interchangeable anvils, For a wide range of applications
- Grey painted steel frame
- Ratchet stop
- Non-rotating spindle
- Inch/Metric conversion
- Upon switching on the display will read the actual absolute measuring position
- Automatic On/Off to maximize battery life
- Absolute or incremental measuring modes

SPECIFICATIONS

Digital models

Inch Range	Accuracy	Metric Range	Accuracy	Inch Code No.	Metric Code No.
0-1"	±0.0001"	0-25mm	±0.004mm	146-01-1	146-01-0
1-2"	±0.0002"	25-50mm	±0.004mm	146-02-1	146-02-0
2-3"	±0.0002"	50-75mm	±0.005mm	146-03-1	146-03-0
3-4"	±0.0002"	75-100mm	±0.005mm	146-04-1	146-04-0
4-5"	±0.0002"	100-125mm	±0.006mm	146-05-1	146-05-0
5-6"	±0.0002"	125-150mm	±0.006mm	146-06-1	146-06-0
6-7"	±0.0002"	150-175mm	±0.007mm	146-07-1	146-07-0
7-8"	±0.0002"	175-200mm	±0.007mm	146-08-1	146-08-0

Mechanical models

Inch Range	Accuracy	Metric Range	Accuracy	Inch Code No.	Metric Code No.
0-1"	±0.0001"	0-25mm	±0.004mm	142-01-1	142-01-0
1-2"	±0.0002"	25-50mm	±0.004mm	142-02-1	142-02-0
2-3"	±0.0002"	50-75mm	±0.005mm	142-03-1	142-03-0
3-4"	±0.0002"	75-100mm	±0.005mm	142-04-1	142-04-0
4-5"	±0.0002"	100-125mm	±0.006mm	142-05-1	142-05-0
5-6"	±0.0002"	125-150mm	±0.006mm	142-06-1	142-06-0
6-7"	±0.0002"	150-175mm	±0.007mm	142-07-1	142-07-0
7-8"	±0.0002"	175-200mm	±0.007mm	142-08-1	142-08-0

Dimension

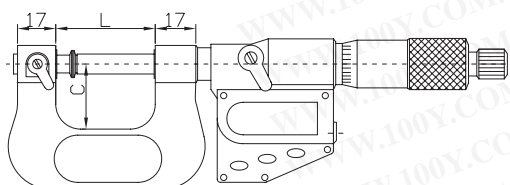

Range	C	L
Inch/Metric	mm	mm
0-1"/0-25mm	26	42
1-2"/25-50mm	38	67
2-3"/50-75mm	50	92
3-4"/75-100mm	62	118
4-5"/100-125mm	70	143
5-6"/125-150mm	82	168
6-7"/150-175mm	95	192
7-8"/175-200mm	107	217

Anvils	Type
Flat	
Spherical	
Blade	
Point	
Spline	
Disc	
Knife-edge	



V-Anvil Micrometers

151 / 155 Series



155-01-1



S-wrench



Battery



Standard



151-01-5

STANDARD ACCESSORIES

- S-wrench, Battery (Digital models), Standard
- Warranty card, Instruction manual, Calibration certificate
- Inch/Metric conversion
- Upon switching on the display will read the actual absolute measuring position
- Automatic On/Off to maximize battery life
- Absolute or incremental measuring modes

FEATURES

- Resolution:
 - Digital reading: .00005" / 0.001mm
 - Scale on digital models: .0001" / 0.01mm
 - Scale on mechanical models: .001" / 0.01mm
- Protection level IP65
- For measuring the outside diameter of cutting tools such as taps, reamers and end mills
- Carbide tipped measuring faces
- Grey painted steel frame
- Ratchet stop

SPECIFICATIONS

Digital models

Inch	Metric	Inch	Metric
Range	Accuracy	Range	Accuracy
3 flutes			
.04-.6"	±0.001"	1-15mm	±0.004mm
.2-.8"	±0.001"	5-20mm	±0.004mm
.8-1.4"	±0.002"	20-35mm	±0.005mm
5 flutes			
.2-1.0"	±0.001"	5-25mm	±0.004mm
1.0-1.8"	±0.002"	25-45mm	±0.005mm

Mechanical models

Inch	Metric	Inch	Metric
Range	Accuracy	Range	Accuracy
3 flutes			
.04-.6"	±0.001"	1-15mm	±0.004mm
.2-.8"	±0.001"	5-20mm	±0.004mm
.8-1.4"	±0.002"	20-35mm	±0.005mm
5 flutes			
.2-1.0"	±0.001"	5-25mm	±0.004mm
1.0-1.8"	±0.002"	25-45mm	±0.005mm

Dimension

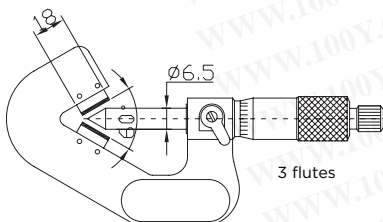

3 flutes

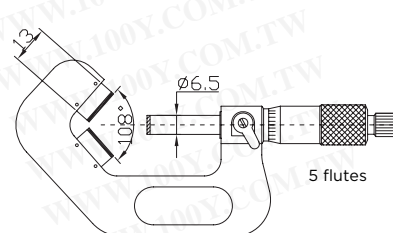

5 flutes



Tube Micrometers

143 / 147 Series



147-01-1



143-01-1



S-wrench



Battery



Standard

FEATURES

- Resolution:
 - Digital reading: .00005" / 0.001mm
 - Scale on digital models: .0001" / 0.01mm
 - Scale on mechanical models: .0001" / 0.01mm
- Protection level IP65
- For measuring wall thickness of various tubes
- Carbide tipped measuring faces
- Grey painted steel frame
- Ratchet stop
- Anvils J and Anvils K are optional

STANDARD ACCESSORIES

- S-wrench, Battery (Digital models), Standard (over 1"/25mm range)
- Warranty card, Instruction manual, Calibration certificate
- Inch/Metric conversion
- Upon switching on the display will read the actual absolute measuring position
- Automatic On/Off to maximize battery life
- Absolute or incremental measuring modes

SPECIFICATIONS

Digital models

Inch	Metric	Inch	Metric	Anvils	Inch	Metric
Range	Accuracy	Range	Accuracy		Code No.	Code No.
0-1"	±.0001"	0-25mm	±0.002mm	J	147-01-1	147-01-0
1-2"	±.0002"	25-50mm	±0.002mm	J	147-02-1	147-02-0
2-3"	±.0002"	50-75mm	±0.003mm	J	147-03-1	147-03-0
3-4"	±.0002"	75-100mm	±0.003mm	J	147-04-1	147-04-0
0-1"	±.0001"	0-25mm	±0.002mm	K	147-01-3	147-01-2
1-2"	±.0002"	25-50mm	±0.002mm	K	147-02-3	147-02-2
2-3"	±.0002"	50-75mm	±0.003mm	K	147-03-3	147-03-2
3-4"	±.0002"	75-100mm	±0.003mm	K	147-04-3	147-04-2

Mechanical models

Inch	Metric	Inch	Metric	Anvils	Inch	Metric
Range	Accuracy	Range	Accuracy		Code No.	Code No.
0-1"	±.0001"	0-25mm	±0.004mm	J	143-01-1	143-01-0
1-2"	±.0002"	25-50mm	±0.004mm	J	143-02-1	143-02-0
2-3"	±.0002"	50-75mm	±0.005mm	J	143-03-1	143-03-0
3-4"	±.0002"	75-100mm	±0.005mm	J	143-04-1	143-04-0
0-1"	±.0001"	0-25mm	±0.004mm	K	143-01-3	143-01-2
1-2"	±.0002"	25-50mm	±0.004mm	K	143-02-3	143-02-2
2-3"	±.0002"	50-75mm	±0.005mm	K	143-03-3	143-03-2
3-4"	±.0002"	75-100mm	±0.005mm	K	143-04-3	143-04-2

Dimension

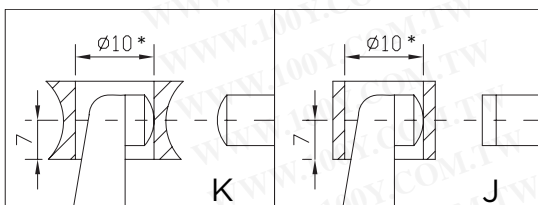

* Min dimension of measured diameter

Tube Micrometers

113 / 114 Series



113-01-1



114-21-0



S-wrench



Battery



Standard

FEATURES

- Resolution:
 - Digital reading: .00005" / 0.001mm
 - Scale on digital models: .0001" / 0.01mm
 - Scale on mechanical models: .0001" / 0.01mm
- Protection level IP65

- For measuring wall thickness of various tubes
- Carbide tipped measuring faces
- Grey painted steel frame
- Ratchet stop
- Six Anvils are optional

STANDARD ACCESSORIES

- S-wrench, Battery (Digital models)
- Standard (25-50mm range)
- Warranty card, Instruction manual, Calibration certificate
- Inch/Metric conversion
- Upon switching on the display will read the actual absolute measuring position
- Automatic On/Off to maximize battery life
- Absolute or incremental measuring modes

SPECIFICATIONS

Digital models

Inch		Metric			Inch		Metric	
Range	Accuracy	Range	Accuracy	Anvils	Code No.	Code No.		
0-1"	±0.0001"	0-25mm	±0.004mm	A	113-01-1	113-01-0		
1-2"	±0.0002"	25-50mm	±0.004mm	A	113-02-1	113-02-0		
0-1"	±0.0001"	0-25mm	±0.004mm	C	113-21-1	113-21-0		
1-2"	±0.0002"	25-50mm	±0.004mm	C	113-22-1	113-22-0		
0-1"	±0.0001"	0-25mm	±0.004mm	E	113-41-1	113-41-0		
1-2"	±0.0002"	25-50mm	±0.004mm	E	113-42-1	113-42-0		
0-1"	±0.0001"	0-25mm	±0.004mm	B	113-11-1	113-11-0		
1-2"	±0.0002"	25-50mm	±0.004mm	B	113-12-1	113-12-0		
0-1"	±0.0001"	0-25mm	±0.004mm	D	113-31-1	113-31-0		
1-2"	±0.0002"	25-50mm	±0.004mm	D	113-32-1	113-32-0		
0-1"	±0.0001"	0-25mm	±0.004mm	F	113-51-1	113-51-0		
1-2"	±0.0002"	25-50mm	±0.004mm	F	113-52-1	113-52-0		

Mechanical models

Inch		Metric			Inch		Metric	
Range	Accuracy	Range	Accuracy	Anvils	Code No.	Code No.		
0-1"	±0.0001"	0-25mm	±0.004mm	A	114-01-1	114-01-0		
1-2"	±0.0002"	25-50mm	±0.004mm	A	114-02-1	114-02-0		
0-1"	±0.0001"	0-25mm	±0.004mm	C	114-21-1	114-21-0		
1-2"	±0.0002"	25-50mm	±0.004mm	C	114-22-1	114-22-0		
0-1"	±0.0001"	0-25mm	±0.004mm	E	114-41-1	114-41-0		
1-2"	±0.0002"	25-50mm	±0.004mm	E	114-42-1	114-42-0		
0-1"	±0.0001"	0-25mm	±0.004mm	B	114-11-1	114-11-0		
1-2"	±0.0002"	25-50mm	±0.004mm	B	114-12-1	114-12-0		
0-1"	±0.0001"	0-25mm	±0.004mm	D	114-31-1	114-31-0		
1-2"	±0.0002"	25-50mm	±0.004mm	D	114-32-1	114-32-0		
0-1"	±0.0001"	0-25mm	±0.004mm	F	114-51-1	114-51-0		
1-2"	±0.0002"	25-50mm	±0.004mm	F	114-52-1	114-52-0		

Dimension

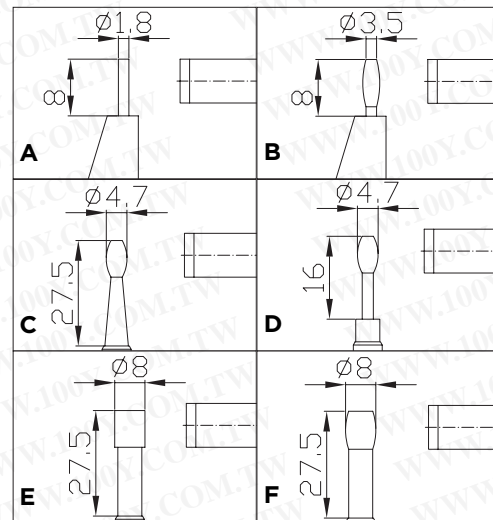



Deep Throat Micrometers

150 / 157 Series



157-51-1

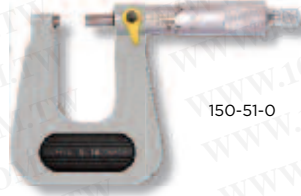

150-51-0



S-wrench



Battery



Standard

FEATURES

- Resolution:
 - Digital reading: .00005" / 0.001mm
 - Scale on digital models: .0001" / 0.01mm
 - Scale on mechanical models: .0001" / 0.01mm
- Protection level IP65
- Three Anvils are optional

- For measuring thickness of sheet metal, paper and sheet plastic
- Carbide tipped measuring faces
- Grey painted steel frame
- Ratchet stop

STANDARD ACCESSORIES

- S-wrench, Battery (Digital models), Standard (25-50mm range)
- Warranty card, Instruction manual, Calibration certificate
- Inch/Metric conversion
- Upon switching on the display will read the actual absolute measuring position
- Automatic On/Off to maximize battery life
- Absolute or incremental measuring modes

SPECIFICATIONS

Digital models

Throat depth	Inch		Metric		Inch Code No.			Metric Code No.		
	Range	Accuracy	Range	Accuracy	Type A	Type B	Type C	Type A	Type B	Type C
50mm	0-1"	±.0002"	0-25mm	±0.004mm	157-01-1	157-31-1	157-51-1	157-01-0	157-31-0	157-51-0
50mm	1-2"	±.0002"	25-50mm	±0.004mm	157-02-1	157-32-1	157-52-1	157-02-0	157-32-0	157-52-0
100mm	0-1"	±.0002"	0-25mm	±0.005mm	157-01-3	157-31-3	157-51-3	157-01-2	157-31-2	157-51-2
100mm	1-2"	±.0002"	25-50mm	±0.005mm	157-02-3	157-32-3	157-52-3	157-02-2	157-32-2	157-52-2
150mm	0-1"	±.0003"	0-25mm	±0.006mm	157-01-5	157-31-5	157-51-5	157-01-4	157-31-4	157-51-4
150mm	1-2"	±.0003"	25-50mm	±0.006mm	157-02-5	157-32-5	157-52-5	157-02-4	157-32-4	157-52-4
300mm	0-1"	±.0003"	0-25mm	±0.007mm	157-01-7	157-31-7	-	157-01-6	157-31-6	-
300mm	1-2"	±.0003"	25-50mm	±0.007mm	157-02-7	157-32-7	-	157-02-6	157-32-6	-

Mechanical models

Throat depth	Inch		Metric		Inch Code No.			Metric Code No.		
	Range	Accuracy	Range	Accuracy	Type A	Type B	Type C	Type A	Type B	Type C
50mm	0-1"	±.0002"	0-25mm	±0.004mm	150-01-1	150-31-1	150-51-1	150-01-0	150-31-0	150-51-0
50mm	1-2"	±.0002"	25-50mm	±0.004mm	150-02-1	150-32-1	150-52-1	150-02-0	150-32-0	150-52-0
100mm	0-1"	±.0002"	0-25mm	±0.005mm	150-01-3	150-31-3	150-51-3	150-01-2	150-31-2	150-51-2
100mm	1-2"	±.0002"	25-50mm	±0.005mm	150-02-3	150-32-3	150-52-3	150-02-2	150-32-2	150-52-2
150mm	0-1"	±.0003"	0-25mm	±0.006mm	150-01-5	150-31-5	150-51-5	150-01-4	150-31-4	150-51-4
150mm	1-2"	±.0003"	25-50mm	±0.006mm	150-02-5	150-32-5	150-52-5	150-02-4	150-32-4	150-52-4
300mm	0-1"	±.0003"	0-25mm	±0.007mm	150-01-7	150-31-7	-	150-01-6	150-31-6	-
300mm	1-2"	±.0003"	25-50mm	±0.007mm	150-02-7	150-32-7	-	150-02-6	150-32-6	-

Dimension

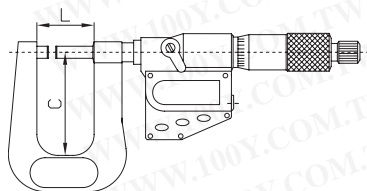

Anvils

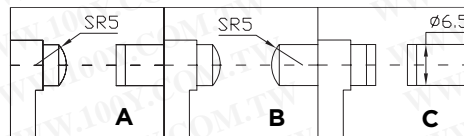

Throat depth	Range	L	C	Range	L	C
mm	Inch/Metric	mm	mm	Inch/Metric	mm	mm
50	0-1"/0-25mm	32	55	1-2"/25-50mm	57	55
100	0-1"/0-25mm	32	105	1-2"/25-50mm	57	105
200	0-1"/0-25mm	32	155	1-2"/25-50mm	57	155
300	0-1"/0-25mm	32	310	1-2"/25-50mm	57	310



Limit Micrometers

133 Series

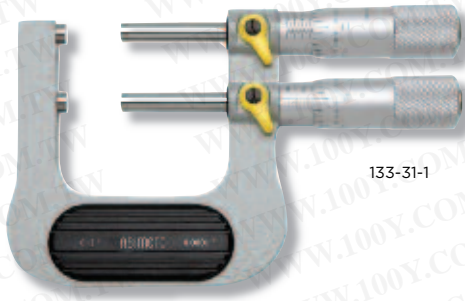

133-31-1

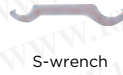

S-wrench



Standard

FEATURES

- Graduation: .0001" / 0.002mm
- Grey painted steel frame
- Carbide tipped measuring faces
- Can be used as a GO/NOGO gauge by setting the upper and lower limits

STANDARD ACCESSORIES

- S-wrench, Standard (25-50mm range)
- Warranty card, Instruction manual, Calibration certificate

SPECIFICATIONS

Inch		Metric		Inch		Metric	
Range	Accuracy	Range	Accuracy	Code No.	Code No.	Code No.	Code No.
0-1"	±.0001"	0-25mm	±0.003mm	133-31-1	133-31-0		
1-2"	±.0002"	25-50mm	±0.003mm	133-32-1	133-32-0		

Dimension

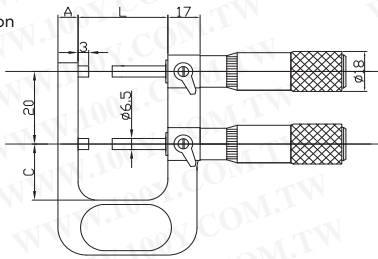

Range	A	L	C
Inch/Metric	mm	mm	mm
0-1"/0-25mm	12	32	24
1-2"/25-50mm	15	57	32

Wire Micrometers

161 Series

FEATURES

- Graduation: .001" / 0.01mm
- Chrome-plated steel feet Frame
- Carbide tipped measuring faces
- For measuring the diameter of wire and small spheres
- Ratchet stop



161-01-0



S-wrench

STANDARD ACCESSORIES

- S-wrench
- Warranty card, Calibration certificate

SPECIFICATIONS

Inch		Metric		Inch		Metric	
Range	Accuracy	Range	Accuracy	Code No.	Code No.	Code No.	Code No.
0-.4"	±.0001"	0-10mm	±0.004mm	161-01-1	161-01-0		



Sheet Metal Micrometers

158 Series

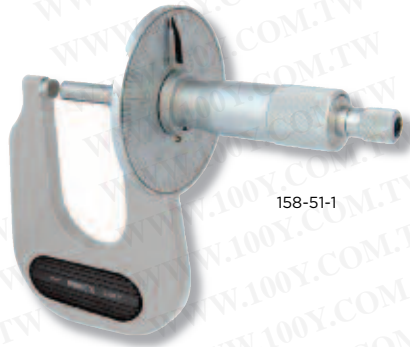

158-51-1



S-wrench

FEATURES

- Graduation: .001" / 0.01mm
- Grey painted steel frame
- Carbide tipped measuring faces
- The dial reading allows for quick reading of sheet metal thickness
- Ratchet stop

STANDARD ACCESSORIES

- S-wrench
- Warranty card, Instruction manual, Calibration certificate

SPECIFICATIONS

Inch		Metric			Inch	Metric
Range	Accuracy	Range	Accuracy	Measuring faces	Code No.	Code No.
0-.6"	±.0001"	0-15mm	±0.004mm	Flat	158-51-1	158-51-0
0-1"	±.0002"	0-25mm	±0.004mm	Flat	158-52-1	158-52-0
1-2"	±.0002"	0-50mm	±0.005mm	Flat	158-53-1	158-53-0
0-.6"	±.0001"	0-15mm	±0.004mm	Spherical	158-51-3	158-51-2
0-1"	±.0002"	0-25mm	±0.004mm	Spherical	158-52-3	158-52-2
0-2"	±.0002"	0-50mm	±0.005mm	Spherical	158-53-3	158-53-2

Dimension

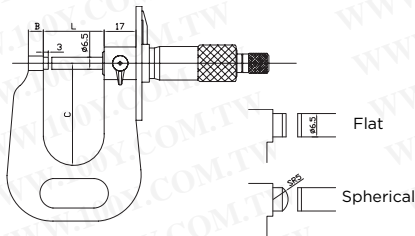

Range	L	B	C
Inch/Metric	mm	mm	mm
0-0.6"/0-15mm	22	8	55
0-1"/0-25mm	32	8	55
0-2"/0-50mm	57	12	105

Hub Micrometers

160 Series



160-01-0

FEATURES

- Graduation: .0001" / 0.01mm
- Carbide tipped measuring faces
- Measures the hub thickness and shoulders inside the bore
- Ratchet stop

STANDARD ACCESSORIES

- S-wrench, Standard (over 1"/25mm range)
- Warranty card, Calibration certificate

S-wrench



Standard



SPECIFICATIONS

Inch		Metric		Inch	Metric
Range	Accuracy	Range	Accuracy	Code No.	Code No.
0-1"	±.0001"	0-25mm	±0.004mm	160-01-1	160-01-0
1-2"	±.0002"	25-50mm	±0.004mm	160-02-1	160-02-0
2-3"	±.0002"	50-75mm	±0.005mm	160-03-1	160-03-0
3-4"	±.0002"	75-100mm	±0.005mm	160-04-1	160-04-0

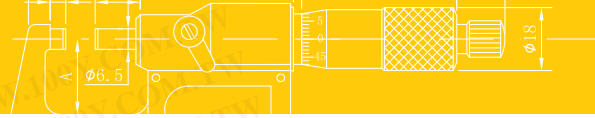

Groove Micrometers

163 Series



163-01-0

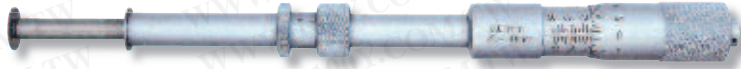

163-02-2



163-61-0



S-wrench



163-62-2

FEATURES

- Graduation: .001" / 0.01mm
- Parallelism: .001" / 0.01mm
- Non-rotating spindle with bi-directional ratchet stop

- Contact faces allow for the measurement of both internal and external grooves, width and flank
- Individual scale readings are provided for inside and outside measurements

STANDARD ACCESSORIES

- S-wrench
- Warranty card, Instruction manual, Calibration certificate

SPECIFICATIONS

	Inch			Metric			Inch	Metric
Flange	Range	Range		Range	Range		Code No.	Code No.
Diameter	Outside	Inside	Accuracy	outside	inside	Accuracy		
Without measuring force								
6.5mm	0-1"	.06-1.05"	±.001"	0-25mm	1.6-26.5mm	±0.01mm	163-01-1	163-01-0
13mm	0-1"	.06-1.05"	±.001"	0-25mm	1.6-26.5mm	±0.01mm	163-01-3	163-01-2
13mm	1-2"	1.05-2.05"	±.001"	25-50mm	26.5-51.5mm	±0.01mm	163-02-3	163-02-2
13mm	2-3"	2.05-3.05"	±.001"	50-75mm	51.5-76.5mm	±0.01mm	163-03-3	163-03-2
13mm	3-4"	3.05-4.05"	±.001"	75-100mm	76.5-101.5mm	±0.01mm	163-04-3	163-04-2
Two-directional measuring force								
6.5mm	0-1"	.06-1.05"	±.001"	0-25mm	1.6-26.5mm	±0.01mm	163-61-1	163-61-0
13mm	0-1"	.06-1.05"	±.001"	0-25mm	1.6-26.5mm	±0.01mm	163-61-3	163-61-2
13mm	1-2"	1.05-2.05"	±.001"	25-50mm	26.5-51.5mm	±0.01mm	163-62-3	163-62-2
13mm	2-3"	2.05-3.05"	±.001"	50-75mm	51.5-76.5mm	±0.01mm	163-63-3	163-63-2
13mm	3-4"	3.05-4.05"	±.001"	75-100mm	76.5-101.5mm	±0.01mm	163-64-3	163-64-2

Dimension

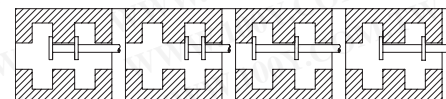
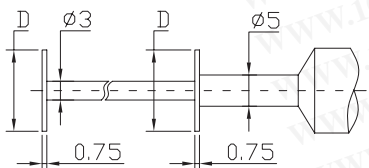
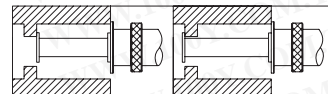
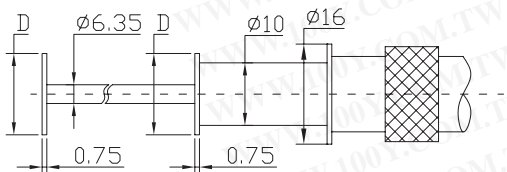



Snap Gauges

181 / 182 Series



181-01-0

FEATURES

- Grey painted steel frame
- Carbide tipped measuring faces
- Dial gauge is not included and is optional, refer to 422-21-1 or 422-21-2 (The measuring resolution is indicative of the dial gauge)
- 8mm diameter stem dial gauge
- Suitable for quickly measuring dimensions of mass-produced work pieces
- Type A and type B measuring anvil configurations are available

SPECIFICATIONS

Type A		Inch	Metric	Type B		Inch	Metric
Range	Range	Code No.	Code No.	Range	Range	Code No.	Code No.
0-1"	0-25mm	181-01-1	181-01-0	0-1.5"	0-40mm	181-01-3	181-01-2
0-2"	0-50mm	181-02-1	181-02-0	1.5-3.5"	40-90mm	181-02-3	181-02-2
2-4"	50-100mm	181-04-1	181-04-0	3.5-5.5"	90-140mm	181-04-3	181-04-2
4-6"	100-150mm	181-06-1	181-06-0	5.5-7.5"	140-190mm	181-06-3	181-06-2
6-8"	150-200mm	181-08-1	181-08-0				

Dimension

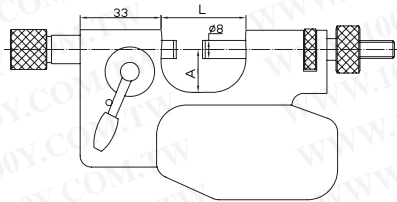

Type A

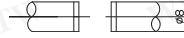

Type B

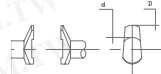

Range	L	A
mm	mm	mm
0-25	34	18
0-50	62	32
50-100	112	62
100-150	162	85
150-200	212	110



182-01-1

FEATURES

- Grey painted steel frame
- Dial gauge is not included and is optional (The measuring resolution is indicative of the dial gauge) Refer to 405-95-4 or 405-95-5
- 8mm diameter stem dial gauge
- Suitable for quickly measuring dimensions of mass-produced work pieces
- The measuring anvils are designed with an angle to allow for easy insertion of the work piece
- Dimension of measuring face: 14x11mm

STANDARD ACCESSORIES

- Warranty card, Instruction manual

SPECIFICATIONS

Inch	Metric			Inch	Metric
Range	Range	L	B	Code No.	Code No.
0-1"	0-25mm	42mm	20mm	182-01-1	182-01-0
0-2"	25-50mm	69mm	32.5mm	182-02-1	182-02-0
2-3"	50-75mm	94mm	45mm	182-03-1	182-03-0
3-4"	75-100mm	119mm	57.5mm	182-04-1	182-04-0
4-5"	100-125mm	144mm	70mm	182-05-1	182-05-0
5-6"	125-150mm	169mm	82.5mm	182-06-1	182-06-0
6-7"	150-175mm	194mm	95mm	182-07-1	182-07-0
7-8"	175-200mm	219mm	107.5mm	182-08-1	182-08-0
8-9"	200-225mm	244mm	120mm	182-09-1	182-09-0
9-10"	225-250mm	269mm	132.5mm	182-10-1	182-10-0
10-11"	250-275mm	294mm	145mm	182-11-1	182-11-0
11-12"	275-300mm	319mm	157.5mm	182-12-1	182-12-0

Dimension

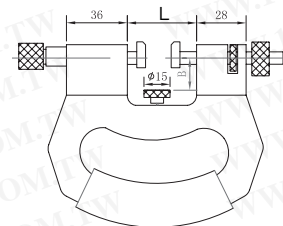

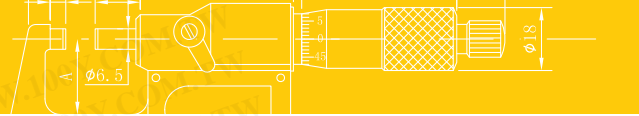

Can Seam Micrometers

162 Series



FEATURES

- Graduation: .001" / 0.01mm
- Painted steel frame
- Measures the width, height, and depth of can seams
- The different models correspond to the type of cans as per the chart below



S-wrench

STANDARD ACCESSORIES

- S-wrench
- Warranty card, Calibration certificate

SPECIFICATIONS

Inch	Metric			Inch Code No.			Metric Code No.		
Range	Accuracy	Range	Accuracy	Steel Cans	Aluminum Cans	Aerosol Cans	Steel Cans	Aluminum Cans	Aerosol Cans
0-.6"	±.0001"	0-13mm	±0.004mm	162-01-1	162-01-3	162-01-5	162-01-0	162-01-2	162-01-4

Digital Micrometer Heads

165 Series



165-01-1

S-wrench

Battery

FEATURES

- Resolution: Digital: .00005" / 0.001mm
- Scale: .0001" / 0.01mm
- Protection level IP65
- Inch/Metric conversion
- Upon switching on the display will read the actual absolute measuring position
- Automatic On/Off to maximize battery life
- Extra large LCD readout
- Absolute or incremental measuring modes
- Carbide tipped measuring faces
- Ratchet stop

SPECIFICATIONS

Inch		Metric				Inch	Metric
Range	Accuracy	Range	Accuracy	Measuring face	Clamp Nut	Code No.	Code No.
0-1"	±.0001"	0-25mm	±0.003mm	Flat & Carbide tipped	w/o	165-01-1	165-01-0
0-1"	±.0001"	0-25mm	±0.003mm	Spherical	w/o	165-01-3	165-01-2
0-1"	±.0001"	0-25mm	±0.003mm	With non-rotating device	w/o	165-01-5	165-01-4
0-1"	±.0001"	0-25mm	±0.003mm	Flat & Carbide tipped	with	165-61-1	165-61-0
0-1"	±.0001"	0-25mm	±0.003mm	Spherical	with	165-61-3	165-61-2
0-1"	±.0001"	0-25mm	±0.003mm	With non-rotating device	with	165-61-5	165-61-4
0-2"	±.0002"	0-50mm	±0.005mm	Flat & Carbide tipped	w/o	165-02-1	165-02-0
0-2"	±.0002"	0-50mm	±0.005mm	Spherical	w/o	165-02-3	165-02-2

Dimension

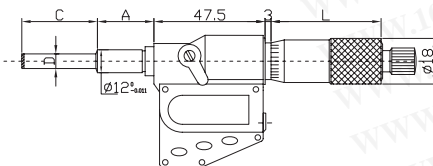

Range	D	A	C	L
0-1"/0-25mm	Φ6.5mm	17.5mm	28.5mm	47mm
0-1"/0-50mm	Φ8mm	35.5mm	53mm	71.5mm



Micrometer Heads

169 Series



169-05-0

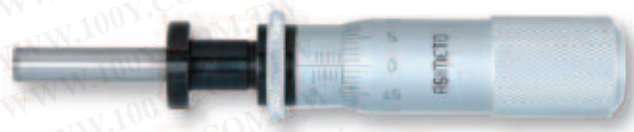

169-92-0

FEATURES

- Satin chrome finish
- Ratchet stop for 0-25mm range

STANDARD ACCESSORIES

- S-wrench
- Warranty card, Instruction manual
- Calibration certificate

SPECIFICATIONS

Inch				Metric								Inch		Metric	
Range	Accuracy	Graduation	Spindle Dia.	Range	Accuracy	Graduation	Spindle Dia.	Spindle Lock	Measuring Face	Clamp Nut	Code No.	Code No.			
0-.5"	±.0001"	.001"	Φ0.197"	0-13mm	±0.004mm	0.01mm	Φ5mm	w/o	Flat	w/o	169-05-1	169-05-0			
0-.5"	±.0001"	.001"	Φ0.197"	0-13mm	±0.004mm	0.01mm	Φ5mm	with	Flat	with	169-05-3	169-05-2			
0-.5"	±.0001"	.001"	Φ0.197"	0-13mm	±0.004mm	0.01mm	Φ5mm	w/o	Spherical	w/o	169-05-5	169-05-4			
0-.5"	±.0001"	.001"	Φ0.197"	0-13mm	±0.004mm	0.01mm	Φ5mm	with	Spherical	with	169-05-7	169-05-6			
0-.5"	±.0001"	.001"	Φ0.197"	0-13mm	±0.004mm	0.01mm	Φ5mm	w/o	Flat	with	169-05-9	169-05-8			
0-1"	±.0001"	.001"	Φ0.256"	0-25mm	±0.004mm	0.01mm	Φ6.5mm	with	Carbide & Flat	w/o	169-92-1*	169-92-0*			
0-1"	±.0001"	.001"	Φ0.256"	0-25mm	±0.004mm	0.01mm	Φ6.5mm	with	Carbide & Flat	with	169-92-3*	169-92-2*			
0-1"	±.0001"	.001"	Φ0.256"	0-25mm	±0.004mm	0.01mm	Φ6.5mm	with	Carbide & Flat	w/o	169-92-5	169-92-4			
0-1"	±.0001"	.001"	Φ0.256"	0-25mm	±0.004mm	0.01mm	Φ6.5mm	with	Carbide & Flat	with	169-92-7	169-92-6			
0-2"	±.0001"	.001"	Φ0.256"	0-50mm	±0.004mm	0.01mm	Φ6.5mm	with	Carbide & Flat	w/o	169-93-1*	169-93-0*			
0-2"	±.0001"	.001"	Φ0.256"	0-50mm	±0.004mm	0.01mm	Φ6.5mm	with	Carbide & Flat	with	169-93-3*	169-93-2*			
0-2"	±.0001"	.001"	Φ0.256"	0-50mm	±0.004mm	0.01mm	Φ6.5mm	with	Carbide & Flat	w/o	169-93-5	169-93-4			
0-2"	±.0001"	.001"	Φ0.256"	0-50mm	±0.004mm	0.01mm	Φ6.5mm	with	Carbide & Flat	with	169-93-7	169-93-6			

* No ratchet stop

Dimension

169-05-0

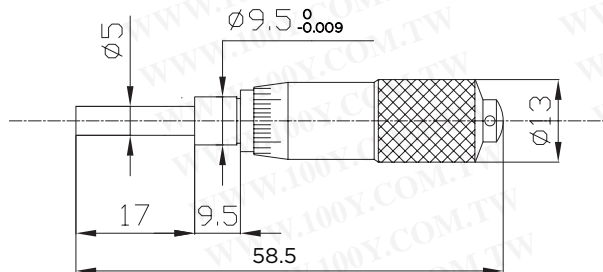

169-05-2/3

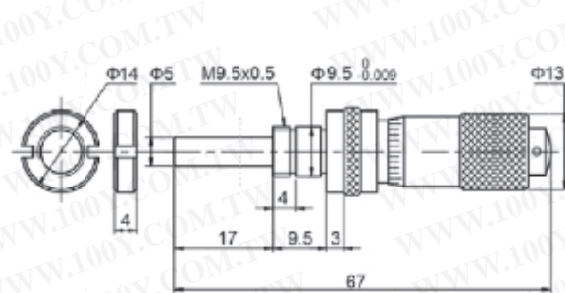

169-92-2/3

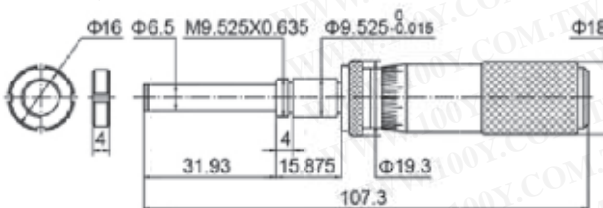

169-93-2/3

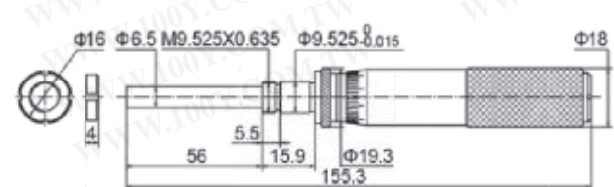



Micrometer Heads

169 Series



169-82-0



169-75-4

SPECIFICATIONS

Inch				Metric						Inch		Metric	
Range	Accuracy	Graduation	Spindle Dia.	Range	Accuracy	Graduation	Spindle Dia.	Spindle Lock	Measuring Face	Clamp Nut	Code No.	Code No.	
0-.2"	±.0001"	.001"	Φ .079"	0-5mm	±0.004mm	0.02mm	Φ2mm	w/o	Flat	w/o	169-82-1	169-82-0	
0-.2"	±.0001"	.001"	Φ .079"	0-5mm	±0.004mm	0.02mm	Φ2mm	w/o	Spherical	w/o	169-82-3	169-82-2	
0-.25"	±.0001"	.001"	Φ .138"	0-6.5mm	±0.004mm	0.01mm	Φ3.5mm	w/o	Flat	w/o	169-65-1	169-65-0	
0-.25"	±.0001"	.001"	Φ .138"	0-6.5mm	±0.004mm	0.01mm	Φ3.5mm	w/o	Spherical	w/o	169-65-3	169-65-2	
0-.25"	±.0001"	.001"	Φ .138"	0-6.5mm	±0.004mm	0.01mm	Φ3.5mm	w/o	Flat	with	169-65-5	169-65-4	
0-.25"	±.0001"	.001"	Φ .138"	0-6.5mm	±0.004mm	0.01mm	Φ3.5mm	w/o	Spherical	with	169-65-7	169-65-6	
0-.25"	±.0001"	.001"	Φ .256"	0-6.5mm	±0.004mm	0.01mm	Φ6.5mm	w/o	Carbide & Flat	w/o	169-75-1	169-75-0	
0-.25"	±.0001"	.001"	Φ .256"	0-6.5mm	±0.004mm	0.01mm	Φ6.5mm	w/o	Carbide & Spherical	w/o	169-75-3	169-75-2	
0-.25"	±.0001"	.001"	Φ .256"	0-6.5mm	±0.004mm	0.01mm	Φ6.5mm	w/o	Carbide & Flat	with	169-75-5	169-75-4	
0-.25"	±.0001"	.001"	Φ .256"	0-6.5mm	±0.004mm	0.01mm	Φ6.5mm	w/o	Carbide & Spherical	with	169-75-7	169-75-6	
0-.25"	±.0001"	.0002"	Φ .256"	0-6.5mm	±0.004mm	0.005mm	Φ6.5mm	w/o	Carbide & Flat	with	169-85-1	169-85-0	
0-.25"	±.0001"	.0002"	Φ .256"	0-6.5mm	±0.004mm	0.005mm	Φ6.5mm	w/o	Carbide & Spherical	with	169-85-3	169-85-2	

Dimension

169-82-0/1

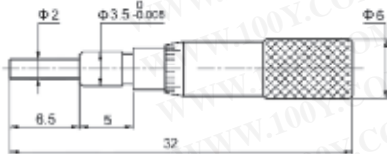

169-65-0/1

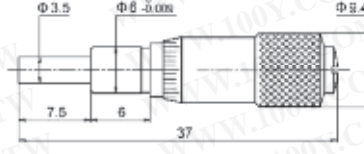

169-65-4/5

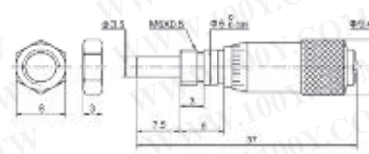

169-85-0/1

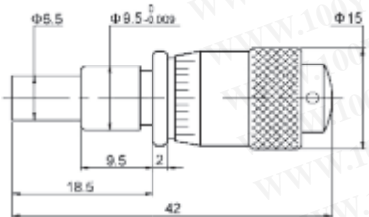

169-75-0/1

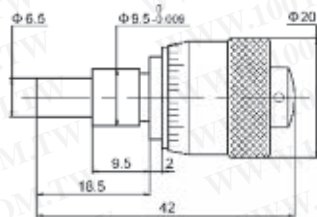

169-75-4/5

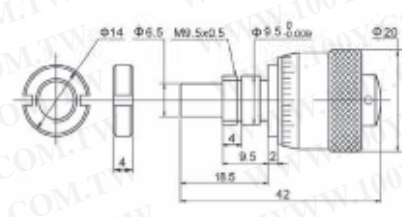



Micrometer Heads

169 Series



169-13-0



169-33-2



169-45-2

SPECIFICATIONS

Inch				Metric								Inch		Metric	
Range	Accuracy	Graduation	Spindle Dia.	Range	Accuracy	Graduation	Spindle Dia.	Spindle Lock	Measuring Face	Clamp Nut	Code No.	Code No.	Code No.	Code No.	
0-.5"	±.0001"	.001"	Φ0.197"	0-13mm	±0.004mm	0.01mm	Φ5mm	with	Flat	w/o	169-06-1	169-06-0			
0-.5"	±.0001"	.001"	Φ0.197"	0-13mm	±0.004mm	0.01mm	Φ5mm	with	Spherical	w/o	169-06-3	169-06-2			
0-.5"	±.0001"	.001"	Φ0.197"	0-13mm	±0.004mm	0.01mm	Φ5mm	w/o	Spherical	with	169-06-5	169-06-4			
0-.5"	±.0001"	.001"	Φ0.197"	0-13mm	±0.004mm	0.01mm	Φ5mm	w/o	Flat	w/o	169-13-1	169-13-0			
0-.5"	±.0001"	.001"	Φ0.197"	0-13mm	±0.004mm	0.01mm	Φ5mm	with	Flat	w/o	169-13-3	169-13-2			
0-.5"	±.0001"	.001"	Φ0.197"	0-13mm	±0.004mm	0.01mm	Φ5mm	w/o	Spherical	w/o	169-13-5	169-13-4			
0-.5"	±.0001"	.001"	Φ0.197"	0-13mm	±0.004mm	0.01mm	Φ5mm	with	Spherical	w/o	169-13-7	169-13-6			
0-.5"	±.0001"	.001"	Φ0.197"	0-13mm	±0.004mm	0.01mm	Φ5mm	w/o	Flat	with	169-23-1	169-23-0			
0-.5"	±.0001"	.001"	Φ0.197"	0-13mm	±0.004mm	0.01mm	Φ5mm	with	Flat	with	169-23-3	169-23-2			
0-.5"	±.0001"	.001"	Φ0.197"	0-13mm	±0.004mm	0.01mm	Φ5mm	w/o	Spherical	with	169-23-5	169-23-4			
0-.5"	±.0001"	.001"	Φ0.197"	0-13mm	±0.004mm	0.01mm	Φ5mm	with	Spherical	with	169-23-7	169-23-6			
0-.5"	±.0001"	.0002"	Φ0.197"	0-13mm	±0.004mm	0.005mm	Φ5mm	w/o	Flat	w/o	169-33-1	169-33-0			
0-.5"	±.0001"	.0002"	Φ0.197"	0-13mm	±0.004mm	0.005mm	Φ5mm	w/o	Carbide & Spherical	w/o	169-33-3	169-33-2			
0-.5"	±.0001"	.0002"	Φ0.197"	0-13mm	±0.004mm	0.005mm	Φ5mm	w/o	Flat	with	169-33-5	169-33-4			
0-.5"	±.0001"	.0002"	Φ0.197"	0-13mm	±0.004mm	0.005mm	Φ5mm	w/o	Spherical	with	169-33-7	169-33-6			
0-.5"	±.0001"	.001"	Φ0.197"	0-13mm	±0.004mm	0.01mm	Φ5mm	with	Carbide & Flat	w/o	169-43-1	169-43-0			
0-.5"	±.0001"	.001"	Φ0.197"	0-13mm	±0.004mm	0.01mm	Φ5mm	with	Carbide & Spherical	w/o	169-43-3	169-43-2			
0-.5"	±.0001"	.001"	Φ0.197"	0-13mm	±0.004mm	0.01mm	Φ5mm	with	Carbide & Flat	with	169-43-5	169-43-4			
0-.5"	±.0001"	.001"	Φ0.197"	0-13mm	±0.004mm	0.01mm	Φ5mm	with	Carbide & Spherical	with	169-43-7	169-43-6			

Dimension

169-06-0/1

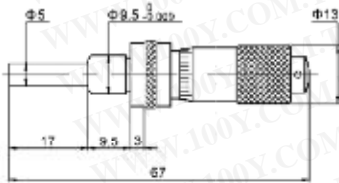

169-45-0/1

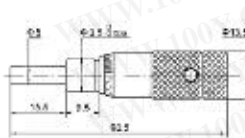

169-23-0/1

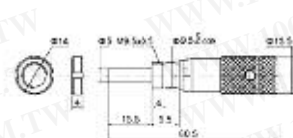

169-06-4/5

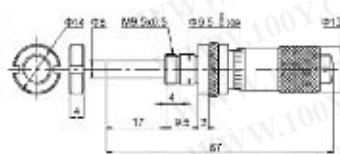

169-13-2/3

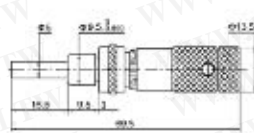

169-23-2/3

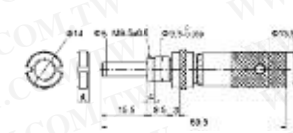

169-33-0/1

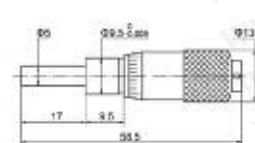

169-33-4/5

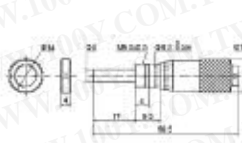

169-45-0/1

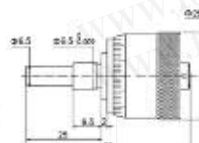

169-45-4/5

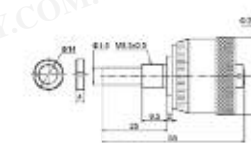



Micrometer Heads

169 Series



SPECIFICATIONS

Inch				Metric						Inch		Metric	
Range	Accuracy	Graduation	Spindle Dia.	Range	Accuracy	Graduation	Spindle Dia.	Spindle Lock	Measuring Face	Clamp Nut	Code No.	Code No.	
0-.6"	±.0001"	.001"	Φ0.197"	0-15mm	±0.004mm	0.01mm	Φ5mm	w/o	Flat	w/o	169-15-1	169-15-0	
0-.6"	±.0001"	.001"	Φ0.197"	0-15mm	±0.004mm	0.01mm	Φ5mm	w/o	Spherical	w/o	169-15-3	169-15-2	
0-.6"	±.0001"	.001"	Φ0.197"	0-15mm	±0.004mm	0.01mm	Φ5mm	w/o	Flat	with	169-15-5	169-15-4	
0-.6"	±.0001"	.001"	Φ0.197"	0-15mm	±0.004mm	0.01mm	Φ5mm	w/o	Spherical	with	169-15-7	169-15-6	
0-.6"	±.0001"	.001"	Φ0.197"	0-15mm	±0.004mm	0.01mm	Φ5mm	with	Flat	w/o	169-25-1	169-25-0	
0-.6"	±.0001"	.001"	Φ0.197"	0-15mm	±0.004mm	0.01mm	Φ5mm	with	Spherical	w/o	169-25-3	169-25-2	
0-.6"	±.0001"	.001"	Φ0.197"	0-15mm	±0.004mm	0.01mm	Φ5mm	with	Flat	with	169-25-5	169-25-4	
0-.6"	±.0001"	.001"	Φ0.197"	0-15mm	±0.004mm	0.01mm	Φ5mm	with	Spherical	with	169-25-7	169-25-6	
0-.5"	±.0001"	.001"	Φ0.315"	0-13mm	±0.004mm	0.01mm	Φ8mm	w/o	Carbide & Flat	w/o	169-35-1	169-35-0	
0-.5"	±.0001"	.001"	Φ0.315"	0-13mm	±0.004mm	0.01mm	Φ8mm	w/o	Carbide & Spherical	w/o	169-35-3	169-35-2	
0-.5"	±.0001"	.001"	Φ0.315"	0-13mm	±0.004mm	0.01mm	Φ8mm	w/o	Carbide & Flat	with	169-35-5	169-35-4	
0-.5"	±.0001"	.001"	Φ0.315"	0-13mm	±0.004mm	0.01mm	Φ8mm	w/o	Carbide & Spherical	with	169-35-7	169-35-6	
0-1"	±.0001"	.001"	Φ0.315"	0-25mm	±0.004mm	0.01mm	Φ8mm	w/o	Carbide & Flat	w/o	169-21-1	169-21-0	
0-1"	±.0001"	.001"	Φ0.315"	0-25mm	±0.004mm	0.01mm	Φ8mm	w/o	Carbide & Spherical	w/o	169-21-3	169-21-2	
0-1"	±.0001"	.001"	Φ0.256"	0-25mm	±0.004mm	0.01mm	Φ6.5mm	w/o	Carbide & Flat	w/o	169-31-1	169-31-0	
0-1"	±.0001"	.001"	Φ0.256"	0-25mm	±0.004mm	0.01mm	Φ6.5mm	w/o	Carbide & Spherical	w/o	169-32-1	169-32-0	
0-1"	±.0001"	.001"	Φ0.315"	0-25mm	±0.004mm	0.01mm	Φ8mm	w/o	Carbide & Flat	w/o	169-31-3	169-31-2	
0-1"	±.0001"	.001"	Φ0.315"	0-25mm	±0.004mm	0.01mm	Φ8mm	w/o	Carbide & Spherical	w/o	169-32-3	169-32-2	
0-1"	±.0001"	.0001"	Φ0.256"	0-25mm	±0.004mm	0.002mm	Φ6.5mm	w/o	Carbide & Flat	w/o	169-31-5	169-31-4	
0-1"	±.0001"	.0001"	Φ0.256"	0-25mm	±0.004mm	0.002mm	Φ6.5mm	w/o	Carbide & Spherical	w/o	169-32-5	169-32-4	
0-1"	±.0001"	.0001"	Φ0.315"	0-25mm	±0.004mm	0.002mm	Φ8mm	w/o	Carbide & Flat	w/o	169-31-7	169-31-6	
0-1"	±.0001"	.0001"	Φ0.315"	0-25mm	±0.004mm	0.002mm	Φ8mm	w/o	Carbide & Spherical	w/o	169-32-7	169-32-6	

Dimension

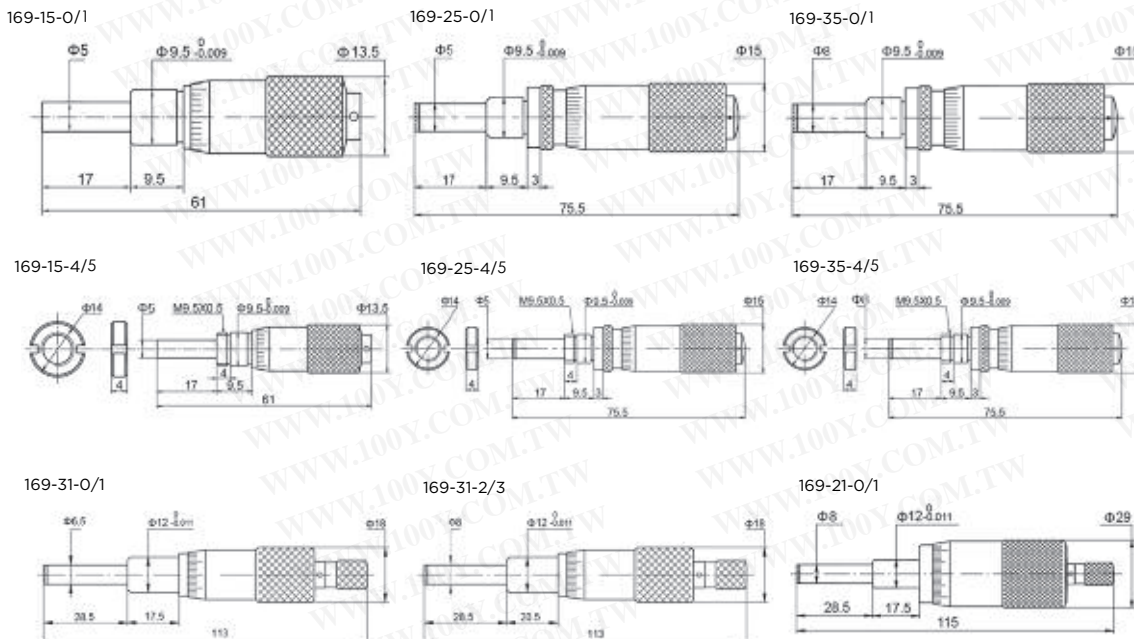

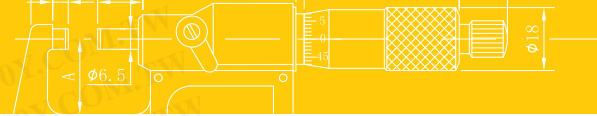

Micrometer Heads

169 Series



169-11-2



169-51-0

SPECIFICATIONS

Inch				Metric						Inch		Metric	
Range	Accuracy	Graduation	Spindle Dia.	Range	Accuracy	Graduation	Spindle Dia.	Spindle Lock	Measuring Face	Clamp Nut	Code No.	Code No.	
0-1"	±.0001"	.001"	Φ0.256"	0-25mm	±0.004mm	0.01mm	Φ6.5mm	w/o	Carbide & Flat	w/o	169-11-3	169-11-2	
0-1"	±.0001"	.001"	Φ0.256"	0-25mm	±0.004mm	0.01mm	Φ6.5mm	w/o	Carbide & Spherical	w/o	169-11-1	169-11-0	
0-1"	±.0001"	.001"	Φ0.256"	0-25mm	±0.004mm	0.01mm	Φ6.5mm	w/o	Carbide & Flat	with	169-01-2	169-01-3	
0-1"	±.0001"	.001"	Φ0.256"	0-25mm	±0.004mm	0.01mm	Φ6.5mm	w/o	Carbide & Spherical	with	169-01-1	169-01-0	
0-1"	±.0001"	.001"	Φ0.256"	0-25mm	±0.004mm	0.01mm	Φ6.5mm	with	Carbide & Flat	w/o	169-41-1	169-41-0	
0-1"	±.0001"	.001"	Φ0.256"	0-25mm	±0.004mm	0.01mm	Φ6.5mm	with	Carbide & Spherical	w/o	169-41-3	169-41-2	
0-1"	±.0001"	.001"	Φ0.256"	0-25mm	±0.004mm	0.01mm	Φ6.5mm	with	Carbide & Flat	with	169-42-1	169-42-0	
0-1"	±.0001"	.001"	Φ0.256"	0-25mm	±0.004mm	0.01mm	Φ6.5mm	with	Carbide & Spherical	with	169-42-3	169-42-2	
0-1"	±.0001"	.001"	Φ0.315"	0-25mm	±0.004mm	0.01mm	Φ8mm	w/o	Carbide & Flat	w/o	169-51-1*	169-51-0*	
0-1"	±.0001"	.001"	Φ0.315"	0-25mm	±0.004mm	0.01mm	Φ8mm	w/o	Carbide & Spherical	w/o	169-52-1*	169-52-0*	
0-1"	±.0001"	.001"	Φ0.315"	0-25mm	±0.004mm	0.01mm	Φ8mm	w/o	Carbide & Flat	w/o	169-53-1	169-53-0	
0-1"	±.0001"	.001"	Φ0.315"	0-25mm	±0.004mm	0.01mm	Φ8mm	w/o	Carbide & Spherical	w/o	169-54-1	169-54-0	
0-1"	±.0001"	.0001"	Φ0.315"	0-25mm	±0.004mm	0.001mm	Φ8mm	w/o	Carbide & Flat	w/o	169-51-3*	169-51-2*	
0-1"	±.0001"	.0001"	Φ0.315"	0-25mm	±0.004mm	0.001mm	Φ8mm	w/o	Carbide & Spherical	w/o	169-52-3*	169-52-2*	
0-1"	±.0001"	.0001"	Φ0.315"	0-25mm	±0.004mm	0.001mm	Φ8mm	w/o	Carbide & Flat	w/o	169-53-3	169-53-2	
0-1"	±.0001"	.0001"	Φ0.315"	0-25mm	±0.004mm	0.001mm	Φ8mm	w/o	Carbide & Spherical	w/o	169-54-3	169-54-2	
0-1"	±.0001"	.001"	Φ0.315"	0-25mm	±0.004mm	0.01mm	Φ8mm	w/o	Carbide & Flat	with	169-51-5*	169-51-4*	
0-1"	±.0001"	.001"	Φ0.315"	0-25mm	±0.004mm	0.01mm	Φ8mm	w/o	Carbide & Spherical	with	169-52-5*	169-52-4*	
0-1"	±.0001"	.001"	Φ0.315"	0-25mm	±0.004mm	0.01mm	Φ8mm	w/o	Carbide & Flat	with	169-53-5	169-53-4	
0-1"	±.0001"	.001"	Φ0.315"	0-25mm	±0.004mm	0.01mm	Φ8mm	w/o	Carbide & Spherical	with	169-54-5	169-54-4	
0-1"	±.0001"	.0001"	Φ0.315"	0-25mm	±0.004mm	0.001mm	Φ8mm	w/o	Carbide & Flat	with	169-51-7*	169-51-6*	
0-1"	±.0001"	.0001"	Φ0.315"	0-25mm	±0.004mm	0.001mm	Φ8mm	w/o	Carbide & Spherical	with	169-52-7*	169-52-6*	
0-1"	±.0001"	.0001"	Φ0.315"	0-25mm	±0.004mm	0.001mm	Φ8mm	w/o	Carbide & Flat	with	169-53-7	169-53-6	
0-1"	±.0001"	.0001"	Φ0.315"	0-25mm	±0.004mm	0.001mm	Φ8mm	w/o	Carbide & Spherical	with	169-54-7	169-54-6	

* No ratchet stop

Dimension

169-11-2/3

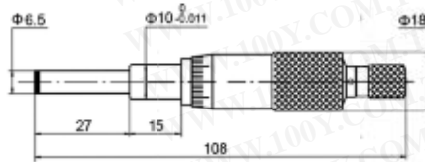

169-41-0/1

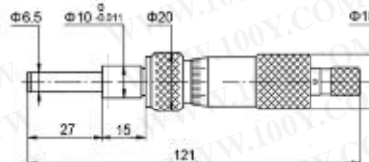

169-51-0/1

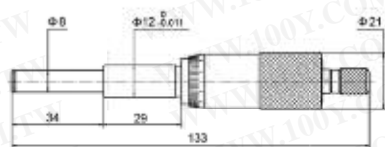

169-01-2/3

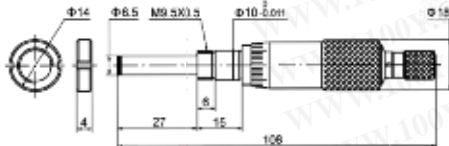

169-42-0/1

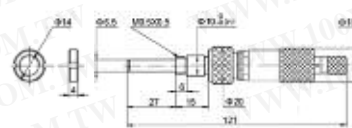

169-51-4/5

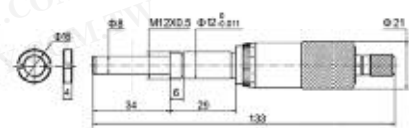



Micrometer Heads

169 Series



169-55-0



169-91-0

SPECIFICATIONS

Inch			Metric				Inch			Metric		
Range	Accuracy	Graduation	Spindle Dia.	Range	Accuracy	Graduation	Spindle Dia.	Spindle Lock	Measuring Face	Clamp Nut	Code No.	Code No.
0-1"	±0.001"	.001"	Φ0.315"	0-25mm	±0.004mm	0.01mm	Φ8mm	with	Carbide & Flat	w/o	169-55-1*	169-55-0*
0-1"	±0.001"	.001"	Φ0.315"	0-25mm	±0.004mm	0.01mm	Φ8mm	with	Carbide & Spherical	w/o	169-56-1*	169-56-0*
0-1"	±0.001"	.001"	Φ0.315"	0-25mm	±0.004mm	0.01mm	Φ8mm	with	Carbide & Flat	w/o	169-57-1	169-57-0
0-1"	±0.001"	.001"	Φ0.315"	0-25mm	±0.004mm	0.01mm	Φ8mm	with	Carbide & Spherical	w/o	169-58-1	169-58-0
0-1"	±0.001"	.0001"	Φ0.315"	0-25mm	±0.004mm	0.001mm	Φ8mm	with	Carbide & Flat	w/o	169-55-3*	169-55-2*
0-1"	±0.001"	.0001"	Φ0.315"	0-25mm	±0.004mm	0.001mm	Φ8mm	with	Carbide & Spherical	w/o	169-56-3*	169-56-2*
0-1"	±0.001"	.0001"	Φ0.315"	0-25mm	±0.004mm	0.001mm	Φ8mm	with	Carbide & Flat	w/o	169-57-3	169-57-2
0-1"	±0.001"	.0001"	Φ0.315"	0-25mm	±0.004mm	0.001mm	Φ8mm	with	Carbide & Spherical	w/o	169-58-3	169-58-2
0-1"	±0.001"	.001"	Φ0.315"	0-25mm	±0.004mm	0.01mm	Φ8mm	with	Carbide & Flat	with	169-55-5*	169-55-4*
0-1"	±0.001"	.001"	Φ0.315"	0-25mm	±0.004mm	0.01mm	Φ8mm	with	Carbide & Spherical	with	169-56-5*	169-56-4*
0-1"	±0.001"	.001"	Φ0.315"	0-25mm	±0.004mm	0.01mm	Φ8mm	with	Carbide & Flat	with	169-57-5	169-57-4
0-1"	±0.001"	.001"	Φ0.315"	0-25mm	±0.004mm	0.01mm	Φ8mm	with	Carbide & Spherical	with	169-58-5	169-58-4
0-1"	±0.001"	.0001"	Φ0.315"	0-25mm	±0.004mm	0.001mm	Φ8mm	with	Carbide & Flat	with	169-55-7*	169-55-6*
0-1"	±0.001"	.0001"	Φ0.315"	0-25mm	±0.004mm	0.001mm	Φ8mm	with	Carbide & Spherical	with	169-56-7*	169-56-6*
0-1"	±0.001"	.0001"	Φ0.315"	0-25mm	±0.004mm	0.001mm	Φ8mm	with	Carbide & Flat	with	169-57-7	169-57-6
0-1"	±0.001"	.0001"	Φ0.315"	0-25mm	±0.004mm	0.001mm	Φ8mm	with	Carbide & Spherical	with	169-58-7	169-58-6
0-2"	±0.001"	.001"	Φ0.256"	0-50mm	±0.004mm	0.01mm	Φ6.5mm	w/o	Carbide & Flat	w/o	169-81-1	169-81-0
0-2"	±0.001"	.001"	Φ0.256"	0-50mm	±0.004mm	0.01mm	Φ6.5mm	w/o	Carbide & Spherical	w/o	169-81-3	169-81-2
0-2"	±0.001"	.001"	Φ0.256"	0-50mm	±0.004mm	0.01mm	Φ6.5mm	w/o	Carbide & Flat	with	169-81-5	169-81-4
0-2"	±0.001"	.001"	Φ0.256"	0-50mm	±0.004mm	0.01mm	Φ6.5mm	w/o	Carbide & Spherical	with	169-81-7	169-81-6
0-.5"	±0.001"	.001"	Φ0.157"	0-13mm	±0.004mm	0.01mm	Φ4mm	w/o	Flat	w/o	169-91-1	169-91-0
0-.5"	±0.001"	.001"	Φ0.197"	0-13mm	±0.004mm	0.01mm	Φ5mm	w/o	Spherical	with	169-91-3	169-91-2

* No ratchet stop

Dimension

169-55-0/1

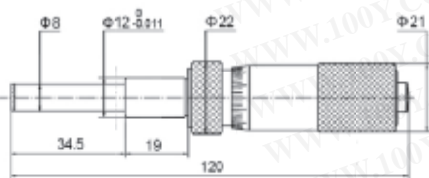

169-81-0/1

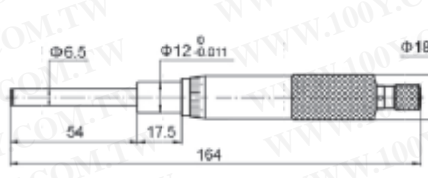

169-91-0/1

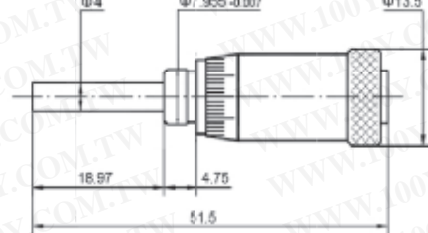

169-55-4/5

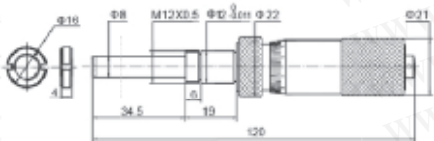

169-81-4/5

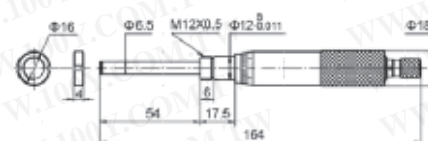

169-91-2/3

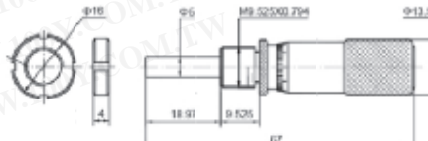



Depth Micrometers

201 / 202 / 205 Series

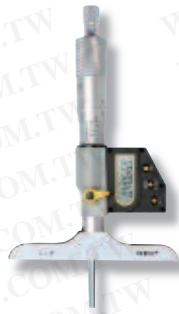

205-04-3



201-06-7



202-62-2

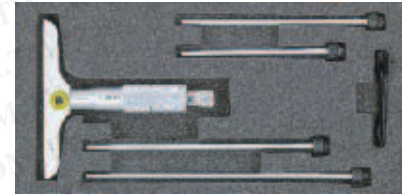

201-04-3



FEATURES

- Resolution:
Digital models: .00005" / 0.001mm
Mechanical models: .001" / 0.01mm
- Protection level IP65
- Ratchet stop
- The integrity of the measurements are maintained throughout the total range of the measuring rods. However the measuring rods must be kept as a set and may not be interchangeable with other depth micrometers sets
- Both flat and spherical depth rod sets are available
- The measurement mode of Absolute or Incremental is displayed when turned on
- The battery life is maximized with the automatic On/Off feature
- Inch/Metric conversion

STANDARD ACCESSORIES

- Battery (Digital models), Rods, Y-wrench, S-wrench, HEX-wrench (Mechanical Models), Torque Wrench (Mechanical Models), Warranty card, Instruction manual, Calibration certificate

SPECIFICATIONS

Inch		Metric				Inch Code No.		Metric Code No.	
Range	Accuracy	Range	Accuracy	Base length	Rods	Flat end	Spherical end	Flat end	Spherical end
Digital models									
0-2"	±.0002"	0-50mm	±.004mm	63mm	2 pcs	205-02-1	205-52-1	205-02-0	205-52-0
0-4"	±.0002"	0-100mm	±.005mm	63mm	4 pcs	205-04-1	205-54-1	205-04-0	205-54-0
0-6"	±.0002"	0-150mm	±.005mm	63mm	6 pcs	205-06-1	205-56-1	205-06-0	205-56-0
0-12"	±.00028"	0-300mm	±.007mm	63mm	12 pcs	205-12-1	205-62-1	205-12-0	205-62-0
0-4"	±.0002"	0-100mm	±.005mm	101.5mm	4 pcs	205-04-3	205-54-3	205-04-2	205-54-2
0-6"	±.0002"	0-150mm	±.005mm	101.5mm	6 pcs	205-06-3	205-56-3	205-06-2	205-56-2
0-12"	±.00028"	0-300mm	±.007mm	101.5mm	12 pcs	205-12-3	205-62-3	205-12-2	205-62-2
Mechanical models (Interchangeable rods)									
0-2"	±.0002"	0-50mm	±.004mm	63mm	2 pcs	202-02-7	202-52-7	202-02-6	202-52-6
0-4"	±.0002"	0-100mm	±.005mm	63mm	4 pcs	202-04-7	202-54-7	202-04-6	202-54-6
0-6"	±.0002"	0-150mm	±.005mm	63mm	6 pcs	202-06-7	202-56-7	202-06-6	202-56-6
0-12"	±.00028"	0-300mm	±.007mm	63mm	12 pcs	202-12-7	202-62-7	202-12-6	202-62-6
0-4"	±.0002"	0-100mm	±.005mm	101.5mm	4 pcs	202-04-9	202-54-9	202-04-8	202-54-8
0-6"	±.0002"	0-150mm	±.005mm	101.5mm	6 pcs	202-06-9	202-56-9	202-06-8	202-56-8
0-12"	±.00028"	0-300mm	±.007mm	101.5mm	12 pcs	202-12-9	202-62-9	202-12-8	202-62-8
Mechanical models (Run through interchangeable rods)									
0-2"	±.0002"	0-50mm	±.004mm	63mm	2 pcs	201-02-1	201-52-1	201-02-0	201-52-0
0-4"	±.0002"	0-100mm	±.005mm	63mm	4 pcs	201-04-1	201-54-1	201-04-0	201-54-0
0-6"	±.0002"	0-150mm	±.005mm	63mm	6 pcs	201-06-1	201-56-1	201-06-0	201-56-0
0-12"	±.00028"	0-300mm	±.007mm	63mm	12 pcs	201-12-1	201-62-1	201-12-0	201-62-0
0-4"	±.0002"	0-100mm	±.005mm	101.5mm	4 pcs	201-04-3	201-54-3	201-04-2	201-54-2
0-6"	±.0002"	0-150mm	±.005mm	101.5mm	6 pcs	201-06-3	201-56-3	201-06-2	201-56-2
0-12"	±.00028"	0-300mm	±.007mm	101.5mm	12 pcs	201-12-3	201-62-3	201-12-2	201-62-2
Mechanical models - Half base									
0-4"	±.0002"	0-100mm	±.005mm	57mm	4 pcs	201-04-7	-	201-04-6	-
0-6"	±.0002"	0-150mm	±.005mm	57mm	6 pcs	201-06-7	-	201-06-6	-

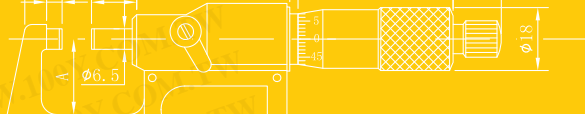

Micrometer Standards

110 Series



110-11-1

110-08-1

110-06-1

FEATURES

- Used for zero point setting of outside micrometers
- Heat insulating handle to prevent heat expansion due to body temperature
- Flat measuring face for up to 11"/275mm size standards
Spherical measuring face for over 12"/300mm size standards

SPECIFICATIONS

Size	Accuracy	Diameter	Inch Code No.
1"	±0.0005"	Φ7mm	110-01-1
2"	±0.0001"	Φ7mm	110-02-1
3"	±0.0001"	Φ7mm	110-03-1
4"	±0.0001"	Φ8mm	110-04-1
5"	±0.00015"	Φ8mm	110-05-1
6"	±0.00015"	Φ8mm	110-06-1
7"	±0.00015"	Φ8mm	110-07-1
8"	±0.00015"	Φ8mm	110-08-1
9"	±0.00020"	Φ8mm	110-09-1
10"	±0.00020"	Φ8mm	110-10-1
11"	±0.00020"	Φ8mm	110-11-1
12"	±0.00025"	Φ16mm	110-12-1
13"	±0.00025"	Φ16mm	110-13-1
14"	±0.00025"	Φ16mm	110-14-1
15"	±0.00025"	Φ16mm	110-15-1
16"	±0.00025"	Φ16mm	110-16-1
17"	±0.00025"	Φ16mm	110-17-1
18"	±0.00025"	Φ16mm	110-18-1
19"	±0.00030"	Φ16mm	110-19-1
20"	±0.00030"	Φ16mm	110-20-1
21"	±0.00030"	Φ16mm	110-21-1
23"	±0.00030"	Φ16mm	110-22-1
25"	±0.00030"	Φ16mm	110-23-1
27"	±0.00035"	Φ16mm	110-24-1
29"	±0.00035"	Φ16mm	110-25-1
31"	±0.00035"	Φ16mm	110-26-1
33"	±0.00035"	Φ16mm	110-27-1
35"	±0.00035"	Φ16mm	110-28-1
37"	±0.00035"	Φ16mm	110-29-1

Size	Accuracy	Diameter	Metric Code No.
25mm	±0.002mm	Φ7mm	110-01-0
50mm	±0.0020mm	Φ7mm	110-02-0
75mm	±0.0020mm	Φ7mm	110-03-0
100mm	±0.0020mm	Φ8mm	110-04-0
125mm	±0.0020mm	Φ8mm	110-05-0
150mm	±0.0030mm	Φ8mm	110-06-0
175mm	±0.0030mm	Φ8mm	110-07-0
200mm	±0.0030mm	Φ8mm	110-08-0
225mm	±0.0040mm	Φ8mm	110-09-0
250mm	±0.0040mm	Φ8mm	110-10-0
275mm	±0.0040mm	Φ8mm	110-11-0
300mm	±0.0050mm	Φ16mm	110-12-0
325mm	±0.0050mm	Φ16mm	110-13-0
350mm	±0.0050mm	Φ16mm	110-14-0
375mm	±0.0050mm	Φ16mm	110-15-0
400mm	±0.0050mm	Φ16mm	110-16-0
425mm	±0.0050mm	Φ16mm	110-17-0
450mm	±0.0060mm	Φ16mm	110-18-0
475mm	±0.0060mm	Φ16mm	110-19-0
500mm	±0.0060mm	Φ16mm	110-20-0
525mm	±0.0060mm	Φ16mm	110-21-0
575mm	±0.0060mm	Φ16mm	110-22-0
625mm	±0.0070mm	Φ16mm	110-23-0
675mm	±0.0070mm	Φ16mm	110-24-0
725mm	±0.0070mm	Φ16mm	110-25-0
775mm	±0.0080mm	Φ16mm	110-26-0
825mm	±0.0080mm	Φ16mm	110-27-0
875mm	±0.0080mm	Φ16mm	110-28-0
925mm	±0.0080mm	Φ16mm	110-29-0
975mm	±0.0080mm	Φ16mm	110-30-0
1050mm	±0.0090mm	Φ23mm	110-31-0
1150mm	±0.0090mm	Φ23mm	110-32-0
1250mm	±0.0090mm	Φ23mm	110-33-0
1350mm	±0.0105mm	Φ23mm	110-34-0
1450mm	±0.0105mm	Φ23mm	110-35-0
1550mm	±0.0105mm	Φ23mm	110-36-0
1650mm	±0.0125mm	Φ23mm	110-37-0
1750mm	±0.0125mm	Φ23mm	110-38-0
1850mm	±0.0125mm	Φ23mm	110-39-0
1950mm	±0.0125mm	Φ23mm	110-40-0



Micrometer Anvil Attachments

146 Series

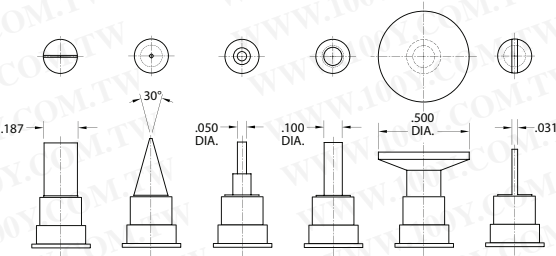

FEATURES

- A must accessory for every Micrometer
- Each Anvil is 1/2" long. Comes with reinforced holding boot, and will fit on any 1-12" Micrometer.
- Anvils are hardened Steel with Black Oxide finish
- Fits .235 and .250 spindle diameters

SPECIFICATIONS

7 PCS Set Code No. : 146-70-0

Individuals	Description	Code No.
Super Spline	.050" face	146-71-0
Spline	.100" face	146-72-0
Blade	.300" thick	146-73-0
Disc	.500" face	146-74-0
Knife	30 degrees	146-75-0
Comparator	30 degrees	146-76-0
Ball attachment	.200"	146-77-0
Ball attachment	5mm	146-77-2 *

* The set not included



Thread Measuring Triangle Set

146 Series

FEATURES

- Measures simulated thread pitch diameter to reference thread chart provided for all 60 degree threads
- Made of hardened steel with black oxide finish
- Set includes:
 - 2 Thread Triangles,
 - 2 rubber holding bands
- Protective hinged plastic case complete with Unified thread chart



Code No.
146-80-0

Calipers

51	IP67 Digital Calipers _SYLVAC SYSTEM	72	Heavy Duty Vernier Calipers (Mono block)
51	IP67 Digital Calipers	73	Heavy Duty Vernier Calipers (Open block)
52	Absolute Digital Calipers	74	Circle Vernier Calipers
52	Digital Calipers (Four Buttons)	74	T Form Marking Calipers
53	Digital Calipers (Three Buttons)	74	Marking Calipers
54	ABS Heavy Duty Digital Calipers	74	Measuring Gauges
55	Ultra Light Heavy Duty Digital CalipersSYLVAC SYSTEM	75	Forester Calipers
56	Ultra Light Digital Universal Depth Gauges _SYLVAC SYSTEM	75	Internal Dial Caliper Gauges
57	ABS Digital Calipers for Outside/Inside Grooves	76	Internal Caliper Gauges
58	ABS Digital Tube Calipers	77	External Caliper Gauges
58	Digital Calipers With Adjustable Measuring Jaw	78	Caliper Extender Attachments
59	Digital Gear Tooth Calipers	79	Universal Caliper Accessory Kits
60	Digital Thickness Gauges	79	Centerline Gauges
61	Digital Gauge With Single Wide Measuring Face	80	Groove Measurement Caliper Jaws
61	Welding Fillet Gauges	81	Tool Kits
62	Mini-type 3-purpose Digital Calipers		
62	Hook Type Digital Calipers		
63	Digital Scales		
64	Dial Calipers		
65	Vernier Calipers		
68	Long Jaw Vernier Calipers (Mono block)		
69	Long Jaw Vernier Calipers (Open block)		
70	Heavy Duty Vernier Calipers With Upper Knife-edge (Mono block)		
71	Heavy Duty Vernier Calipers With Upper Knife-edge (Open block)		

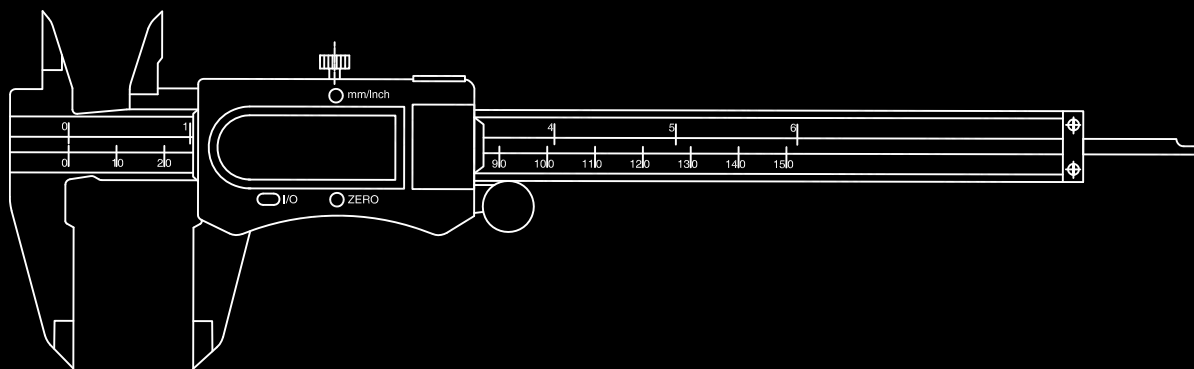

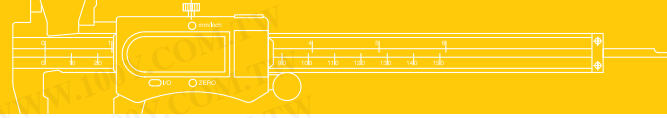

IP67 Digital Calipers _ SYLVAC SYSTEM 301 Series



301-06-0

FEATURES

- Resolution: .0005" / 0.01mm
- Conforms to the IP67 ratings
- Inch/Metric conversion
- Auto power ON/OFF
- Sylvac system

SPECIFICATIONS

Inch		Metric		Code No.	Remark
Range	Accuracy	Range	Accuracy		
0-6"	±.001"	0-150mm	±0.02mm	301-06-0	
0-6"	±.001"	0-150mm	±0.02mm	301-06-2	round depth bar Φ 1.5mm
0-8"	±.0015"	0-200mm	±0.03mm	301-08-0	
0-12"	±.0015"	0-300mm	±0.03mm	301-12-0	

STANDARD ACCESSORIES

- Battery
- Warranty card, Instruction manual, Calibration certificate

IP67 Digital Calipers 305 Series



305-06-2



STANDARD ACCESSORIES

- Battery, Screwdriver
- Warranty card, Instruction manual, Calibration certificate

FEATURES

- Resolution: .0005" / 0.01mm
- Absolute function, there is no need to set the zero
- Absolute or incremental measuring modes
- Metal Housing, the design will allow the caliper to be used in normal workshop conditions and is resistant to coolant, water, dust or oil
- Conforms to the IP67 ratings
- Hold function for easy reading
- Inch/Metric conversion
- Auto power ON/OFF
- Power: 3V lithium battery
- With Thumb Wheel

SPECIFICATIONS

Inch		Metric		Code No.
Range	Accuracy	Range	Accuracy	
0-6"	±.001"	0-150mm	±0.02mm	305-06-2
0-8"	±.0015"	0-200mm	±0.03mm	305-08-2
0-12"	±.0015"	0-300mm	±0.03mm	305-12-2

Dimension

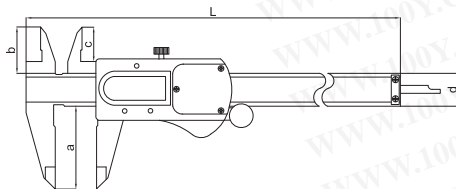

Range	L	a	b	c	d
Inch/Metric	mm	mm	mm	mm	mm
0-6"/0-150mm	236	40	21	16.5	16
0-8"/0-200mm	286	50	24	19.5	16
0-12"/0-300mm	400	60	25	20.5	16

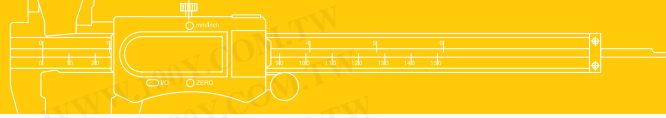

Absolute Digital Calipers

307 Series



307-56-3

FEATURES

- Resolution: .0005" / 0.01mm
- The caliper will be ready for measurements as soon as it is switched on with the LCD screen displaying the actual slider position. There is no need to set the zero position each time the caliper is used as the origin setting is retained even when the caliper is switched off
- Absolute system delivers reliable measurement
- Inch/Metric conversion
- A thumb wheel is provided for easy use
- Cable data output: 900-05-4/5
- The wireless data output is suitable for 901-00-1

SPECIFICATIONS

Inch	Metric	With Thumb Wheel	W/O Thumb Wheel
Range	Accuracy	Range	Accuracy
0-6"	±.001"	0-150mm	±0.02mm
0-8"	±.0015"	0-200mm	±0.03mm
0-12"	±.0015"	0-300mm	±0.03mm

STANDARD ACCESSORIES

- Battery
- Warranty card, Instruction manual, Calibration certificate

Dimension

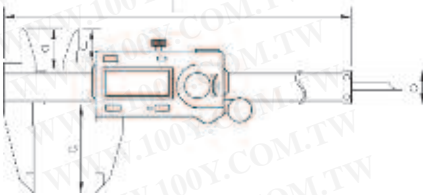

Range	L	a	b	c	d
Inch/Metric	mm	mm	mm	mm	mm
0-6"/0-150mm	236	40	21	16.5	16
0-8"/0-200mm	286	50	24	19.5	16
0-12"/0-300mm	400	60	25	20.5	16

Digital Calipers (Four Buttons)

307 Series

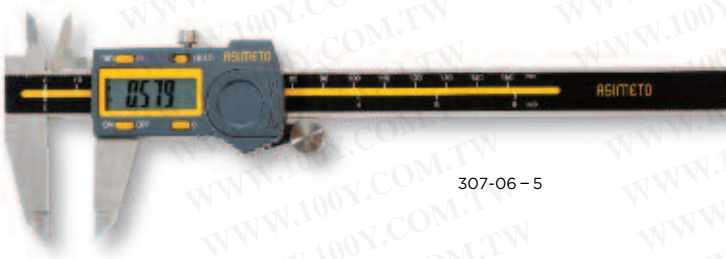

307-06-5

FEATURES

- Resolution: .0005" / 0.01mm
- Extra large LCD readout
- The origin position is retained through the ON/OFF cycle
- Inch/Metric conversion

SPECIFICATIONS

Inch	Metric	With Thumb Wheel	W/O Thumb Wheel
Range	Accuracy	Range	Accuracy
0-4"	±.001"	0-100mm	±0.02mm
0-6"	±.001"	0-150mm	±0.02mm
0-8"	±.0015"	0-200mm	±0.03mm
0-12"	±.0015"	0-300mm	±0.03mm

STANDARD ACCESSORIES

- Battery
- Warranty card, Instruction manual, Calibration certificate

Dimension

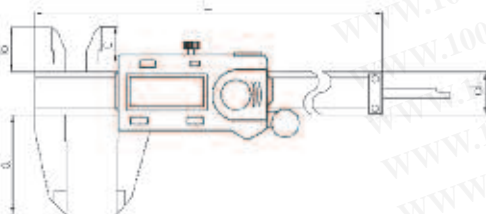

Range	L	a	b	c	d
Inch/Metric	mm	mm	mm	mm	mm
0-4"/0-100mm	176	35	19	13.5	16
0-6"/0-150mm	236	40	21	16.5	16
0-8"/0-200mm	286	50	24	19.5	16
0-12"/0-300mm	400	60	25	20.5	17

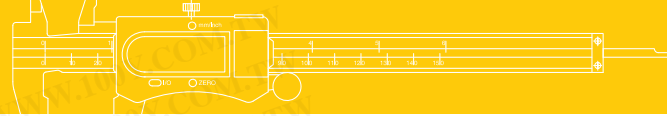

Digital Calipers (Three Buttons)

307 Series



307-XX-0 Series
Without Thumb Wheel



307-XX-1 Series
With Thumb Wheel



307-XX-6 Series
Fractional Electronic Calipers



307-XX-3 Series
Carbide tipped measuring faces

FEATURES

- Resolution: .0005" / 0.01mm / 1/128"
- Extra large LCD readout
- The origin position is retained through the ON/OFF cycle
- Inch/Metric conversion
- Three models are optional

STANDARD ACCESSORIES

- Battery
- Warranty card, Instruction manual, Calibration certificate

SPECIFICATIONS

Inch		Metric		With Thumb Wheel	W/O Thumb Wheel
Range	Accuracy	Range	Accuracy	Code No.	Code No.
General measuring surface					
0-6"	±.001"	0-150mm	±0.02mm	307-06-1	307-06-0
0-8"	±.0015"	0-200mm	±0.03mm	307-08-1	307-08-0
0-12"	±.0015"	0-300mm	±0.04mm	307-12-1	307-12-0
Carbide tipped measuring faces					
0-6"	±.001"	0-150mm	±0.02mm	307-06-3	-
0-8"	±.0015"	0-200mm	±0.03mm	307-08-3	-
0-12"	±.0015"	0-300mm	±0.04mm	307-12-3	-
Fractional Electronic Calipers					
0-6"	±.001"	0-150mm	±0.02mm	307-06-6	-
0-8"	±.0015"	0-200mm	±0.03mm	307-08-6	-

Dimension

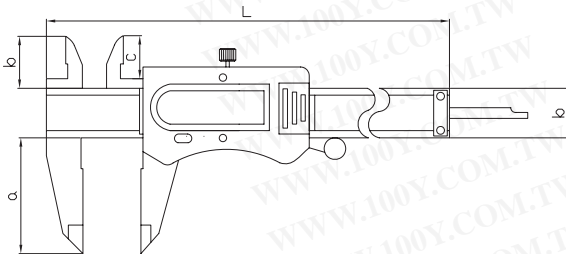

Range	L	a	b	c	d
Inch/Metric	mm	mm	mm	mm	mm
0-6"/0-150mm	236	40	21	16.5	16
0-8"/0-200mm	286	50	24	19.5	16
0-12"/0-300mm	400	60	25	20.5	17

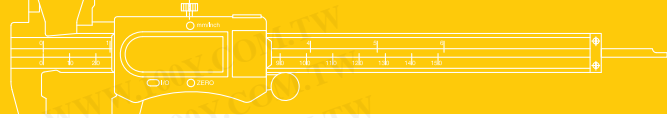

ABS Heavy Duty Digital Calipers

315 Series



FEATURES

- Resolution: .0005" / 0.01mm
- Designed with fine adjustment to allow precise movement of the slider
- Internal measurement jaws are rounded to provide accurate measurement of internal diameters
- Minimum internal diameter measurement capability of 20mm
- Inch/Metric conversion
- Six buttons
- Zero setting at any position
- Models are available with or without upper jaws
- Absolute delivery reliable measurement
- Cable data output: 900-05-4/5
- Wireless data output: 901-00-1

STANDARD ACCESSORIES

- Battery
- Warranty card, Instruction manual, Calibration certificate

SPECIFICATIONS

Inch		Metric		Accuracy	Jaw Length	Code No.
Range	Resolution	Range	Resolution			
Without Upper Jaws						
0-12"	.0005"	0-300mm	0.01mm	±0.04mm	90mm	315-12-6
0-20"	.0005"	0-500mm	0.01mm	±0.05mm	150mm	315-20-6
0-24"	.0005"	0-600mm	0.01mm	±0.05mm	100mm	315-24-6
0-32"	.0005"	0-800mm	0.01mm	±0.07mm	150mm	315-32-6
0-40"	.0005"	0-1000mm	0.01mm	±0.07mm	150mm	315-40-6
With Upper Jaws						
0-12"	.0005"	0-300mm	0.01mm	±0.04mm	90mm	315-12-8
0-20"	.0005"	0-500mm	0.01mm	±0.05mm	150mm	315-20-8
0-32"	.0005"	0-800mm	0.01mm	±0.07mm	150mm	315-32-8
0-40"	.0005"	0-1000mm	0.01mm	±0.07mm	150mm	315-40-8

Remark: Special Jaw Length are upon requested

Dimension

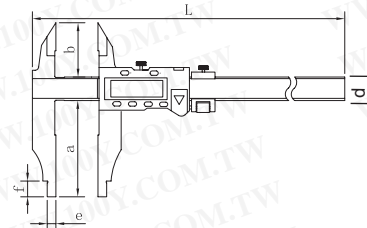
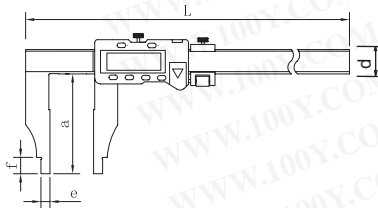

Range	L	a	d	e	f
Inch/Metric	mm	mm	mm	mm	mm
0-12"/0-300mm	470	90	25	10	18
0-20"/0-500mm	680	150	25	10	18
0-24"/0-600mm	730	100	25	10	18
0-32"/0-800mm	1030	150	32	10	25
0-40"/0-1000mm	1230	150	32	10	25

Range	L	a	b	d	e	f
Inch/Metric	mm	mm	mm	mm	mm	mm
0-12"/0-300	470	90	56	25	10	18
0-20"/0-500	680	150	56	25	10	25
0-32"/0-800	1030	150	67	32	10	25
0-40"/0-1000	1230	150	67	32	10	25

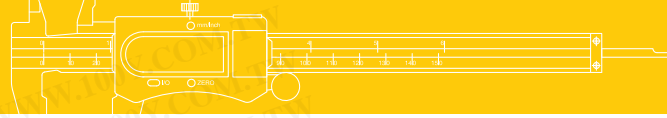

Ultra Light Heavy Duty Digital Calipers _SYLVAC SYSTEM 312 Series



312-20-4

FEATURES

- Resolution: .0005" / 0.01mm
- Lightweight design
- Optimum guidance and sliding characteristics due to double Vee guides.
- Stainless steel jaws, precision ground.
- Inch/Metric conversion

STANDARD ACCESSORIES

- Battery
- Warranty card, Instruction manual, Calibration certificate



312-12-0

SPECIFICATIONS

Inch	Metric						
Range	Range	Accuracy	Jaw Length	Internal Jaw	Power	Remark	Code No.
With Upper Jaws							
0-12"	0-300mm	±0.04mm	90mm	10mm	LR44 1.5V	-	312-12-0
0-20"	0-500mm	±0.05mm	90mm	10mm	LR44 1.5V	-	312-20-0
0-32"	0-800mm	±0.06mm	90mm	10mm	LR44 1.5V	-	312-32-0
Without Upper Jaws							
0-40"	0-1000mm	±0.06mm	150mm	20mm	CR2032 3V	Sylvac Electronics	312-40-2
0-60"	0-1500mm	±0.07mm	150mm	20mm	CR2032 3V	Sylvac Electronics	312-60-2
0-80"	0-2000mm	±0.08mm	150mm	20mm	CR2032 3V	Sylvac Electronics	312-80-2
0-120"	0-3000mm	±0.18mm	150mm	20mm	CR2032 3V	Sylvac Electronics	312-20-4

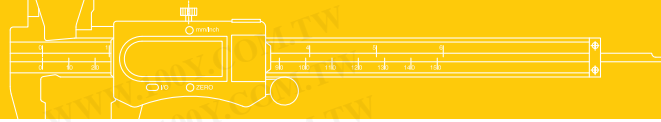

Ultra Light Digital Universal Depth Gauges _SYLVAC SYSTEM 312 Series



FEATURES

- Resolution: .0005" / 0.01mm
- Lightweight design
- Easy to read display. Optimum sliding characteristics are ensured by double Vee guides. Measurement head of hard-coated Aluminium with two tapped holes at 90° (M2.5) to take the measuring tips.
- Inch/Metric conversion
- Power: LR44 1.5V Battery

STANDARD ACCESSORIES

- Battery, Base (Each one of 150mm, 300mm, 450mm), Φ 2mm Contact Point
- Warranty card, Instruction manual, Calibration certificate



SPECIFICATIONS

Inch	Metric		
Range	Range	Accuracy	Code No.
0-12"	0-300mm	\pm 0.04mm	312-12-6
0-20"	0-500mm	\pm 0.05mm	312-20-6
0-32"	0-800mm	\pm 0.06mm	312-32-6

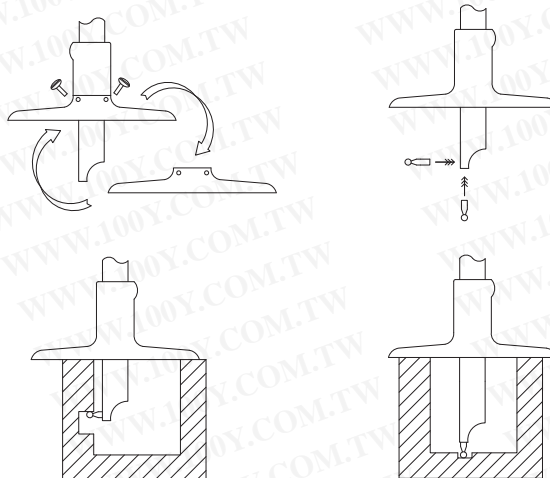



ABS Digital Calipers for Outside/Inside Grooves

309 Series



309-06-3



309-06-4

FEATURES

- Resolution: .0005" / 0.01mm
- Series 309: Measures external grooves and recessed hub dimensions
- Series 315: Measures internal grooves, bores and other details
- Inch/Metric conversion
- Zero-setting at any position for incremental measurement
- ABS system delivery reliable measurement
- Automatic Off to maximize battery life
- Cable data output: 900-05-4/5
- Wireless data output: 901-00-1

STANDARD ACCESSORIES

- Battery
- Warranty card, Instruction manual, Calibration certificate

SPECIFICATIONS

Inch			Metric			
Range	Resolution	Accuracy	Range	Resolution	Accuracy	Code No.
Outside groove						
0-6"	.0005"	±.001"	0-150mm	0.01mm	±0.03mm	309-06-3
0-8"	.0005"	±.0015"	0-200mm	0.01mm	±0.04mm	309-08-3
0-12"	.0005"	±.0015"	0-300mm	0.01mm	±0.04mm	309-12-3
Inside groove						
0.8-6"	.0005"	±.001"	20-150mm	0.01mm	±0.04mm	309-06-4
1-8"	.0005"	±.0015"	25-200mm	0.01mm	±0.04mm	309-08-4
1.2-12"	.0005"	±.002"	30-300mm	0.01mm	±0.05mm	309-12-4

Dimension

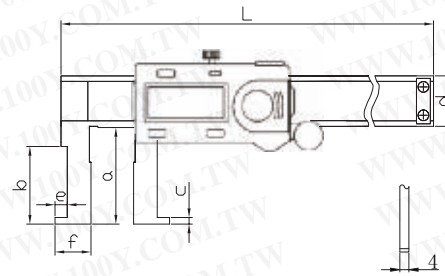
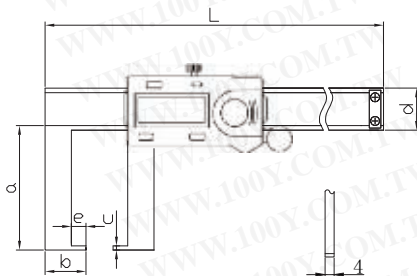

Range	L	a	b	c	d	e
Inch/Metric	mm	mm	mm	mm	mm	mm
0-6"/0-150mm	250	40	10	1	16	5
0-8"/0-200mm	300	50	19	1	16	7
0-12"/0-300mm	405	60	21	2	20	10

Range	L	a	b	c	d	e	f
Inch/Metric	mm	mm	mm	mm	mm	mm	mm
.8-6"/20-150mm	235	36	40	1	16	4.8	10
1.0-8"/25-200mm	287	46	70	1.5	16	4.8	12.5
1.2-12"/30-300mm	390	56	80	1.5	17	7.2	15

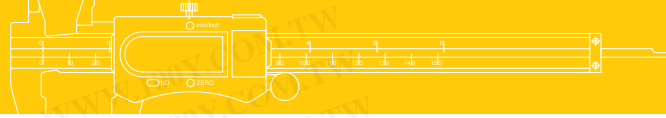

ABS Digital Tube Calipers

316 Series



316-06-2

Dimension

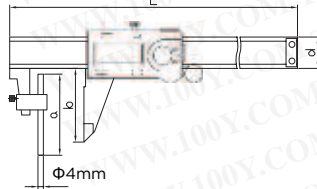

SPECIFICATIONS

Inch		Metric		L	a	b	d	
Range	Accuracy	Range	Accuracy	mm	mm	mm	mm	Code No.
0-6"	±.001"	0-150mm	±0.03mm	250	46	40	16	316-06-2
0-8"	±.0015"	0-200mm	±0.03mm	300	50	50	16	316-08-2
0-12"	±.0015"	0-300mm	±0.04mm	400	66	60	17	316-12-2

FEATURES

- Resolution: .0005" / 0.01mm
- The design incorporates a cylindrical stationary jaw on the beam with a normal jaw on the slider and is used for the measurement of tubular wall thicknesses
- Inch/Metric conversion
- Zero-setting at any position
- ABS system delivery reliable measurement
- Cable data output: 900-05-4/5
- Wireless data output: 901-00-1

STANDARD ACCESSORIES

- Battery
- Warranty card, Instruction manual, Calibration certificate

Digital Calipers With Adjustable Measuring Jaw

317 Series



317-06-0

Dimension

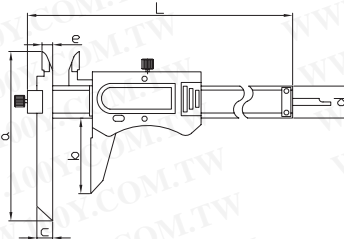

SPECIFICATIONS

Inch		Metric		L	a	b	c	d	e	
Range	Accuracy	Range	Accuracy	mm	mm	mm	mm	mm	mm	Code No.
0-6"	±.0015"	0-150mm	±0.04mm	239	110	40	10	16	7	317-06-0
0-8"	±.0015"	0-200mm	±0.04mm	289	120	50	10	16	7	317-08-0
0-12"	±.0020"	0-300mm	±0.05mm	389	130	60	10	16	7	317-12-0

FEATURES

- Resolution: .0005" / 0.01mm
- The stationary jaw on the beam is designed with vertical movement for the purpose of measuring various steps of different heights
- Inch/Metric conversion
- Zero-setting at any position

STANDARD ACCESSORIES

- Battery
- Warranty card, Instruction manual, Calibration certificate

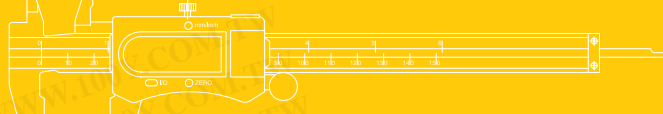

Digital Gear Tooth Calipers

328 / 330Series



328-06-0

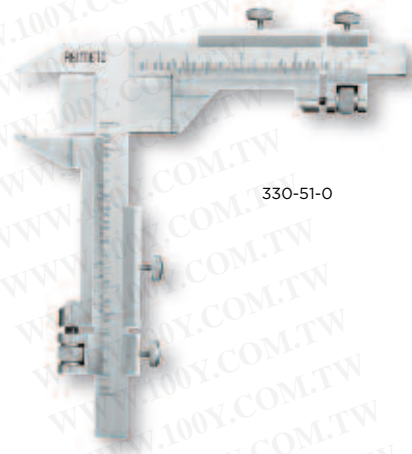

330-51-0

FEATURES

- Resolution:
 - Digital models: .0005" / 0.01mm
 - Vernier models: 0.02mm
- Measures the chordal gear tooth thickness at the chordal addendum (pitch circle)
- Inch/Metric conversion
- Zero-setting at any position

STANDARD ACCESSORIES

- Battery
- Warranty card, Instruction manual, Calibration certificate

Dimension

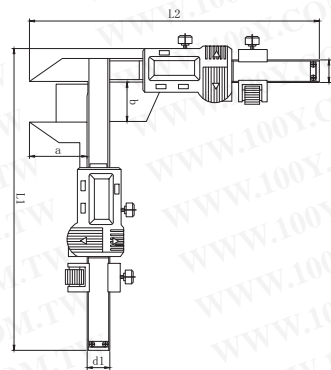

SPECIFICATIONS

Inch	Metric	Accuracy	L1	L2	a	b	d1	d2	Code No.
Range	Range	mm	mm	mm	mm	mm	mm	mm	
M0.04-1"	M1-25	±0.03	156	156.5	30.5	21	13	13	328-06-0
M0.2-2"	M5-50	±0.03	210	185.5	50.5	50.5	13	13	328-06-2
M0.04-1"	M1-25	±0.03	166	166	30.5	21	13	13	330-51-0
M0.2-2"	M5-50	±0.03	220	195	50.5	50.5	13	13	330-52-0

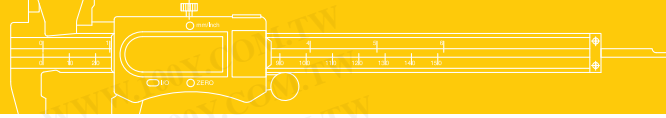

Digital Thickness Gauges

325 Series



325-32-0



325-30-0



325-50-0

FEATURES

- Resolution: .0005" / 0.01mm
- Inch/Metric conversion
- For measuring the thickness of paper, film, wire, sheet metal, jewelry, leather and similar materials
- Light weight, easy to operate

STANDARD ACCESSORIES

- Battery
- Warranty card, Instruction manual, Calibration certificate

SPECIFICATIONS

Inch			Metric			Code No.
Range	Resolution	Accuracy	Range	Resolution	Accuracy	
Horizontal						
0-5"	.0005"	±0.015"	0-12mm	0.01mm	±0.03mm	325-30-0
0-1"	.0005"	±0.015"	0-25mm	0.01mm	±0.04mm	325-32-0
Vertical						
0-.6"	.0005"	±0.015"	0-15mm	0.01mm	±0.03mm	325-50-0
0-1"	.0005"	±0.015"	0-25mm	0.01mm	±0.04mm	325-52-0

Dimension

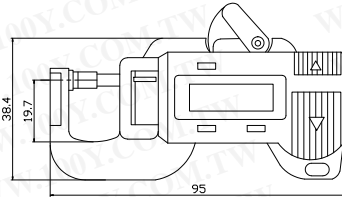
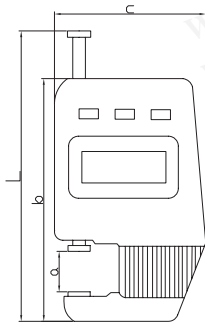

Range	L	a	b	c
Inch/Metric	mm	mm	mm	mm
0-0.6"/0-15mm	102.6	15.5	83.6	51
0-1"/0-25mm	132.8	26	104	61

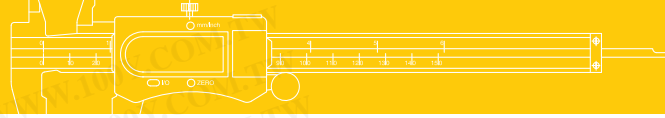

Digital Gauge With Single Wide Measuring Face

325 Series



325-36-0

Dimension

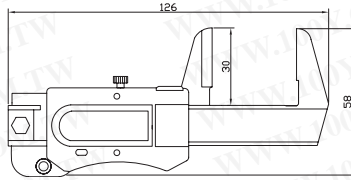

FEATURES

- Resolution: .0005" / 0.01mm
- Zero-setting at any position
- Inch/Metric conversion
- Easy operation and normally used for the measurement of small work pieces

STANDARD ACCESSORIES

- Battery
- Warranty card, Instruction manual, Calibration certificate

SPECIFICATIONS

Inch		Metric		Code No.
Range	Accuracy	Range	Accuracy	
0-1.2"	.0015"	0-30mm	±0.03mm	325-36-0

Welding Fillet Gauges

325 Series



325-05-6

Dimension

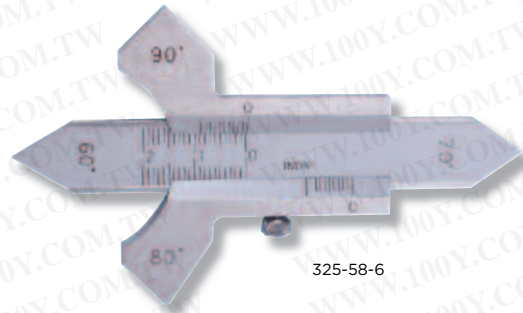
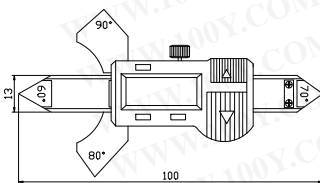

325-58-6

FEATURES

- Resolution:
 - Digital models: .0005" / 0.01mm
 - Mechanical Models: 0.1mm
- Measures the thickness of a weld along the intersecting vector of two right angle welded objects
- Inch/Metric conversion

STANDARD ACCESSORIES

- Battery (Digital models)
- Warranty card, Instruction manual

SPECIFICATIONS

Inch		Metric		Code No.
Range	Accuracy	Range	Accuracy	
Digital models				
0-.5"	±0.015"	0-12.5mm	±0.03mm	325-05-6
0-.8"	±0.015"	0-20mm	±0.03mm	325-08-6
Mechanical models				
-	-	0-20mm	±0.3mm	325-58-6

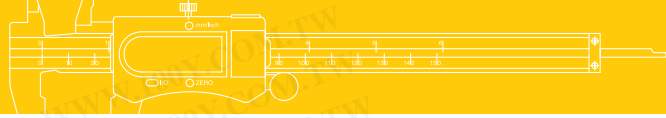

Mini-type 3-purpose Digital Calipers

305 Series



305-40-0

Dimension

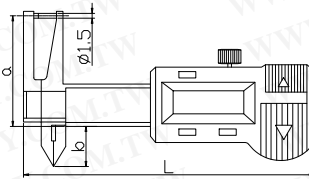

FEATURES

- Resolution: .0005" / 0.01mm
- For measuring the dimension of small workpiece
- Inch/Metric conversion
- Zero-setting at any position

STANDARD ACCESSORIES

- Battery
- Warranty card, Instruction manual, Calibration certificate

SPECIFICATIONS

Inch			Metric			L	a	b	Code No.
Range	Resolution	Accuracy	Range	Resolution	Accuracy				
0-6"	.0005"	±.0015"	0-15mm	0.01mm	±0.03mm	77mm	33.2mm	12.5mm	305-40-0
0-1"	.0005"	±.0015"	0-25mm	0.01mm	±0.03mm	87mm	33.2mm	12.5mm	305-42-0

Hook Type Digital Calipers

325 Series



325-05-0

FEATURES

- Resolution: .0005" / 0.01mm
- Measures the inside groove width and position of groove
- Inch/Metric conversion
- Zero-setting at any position

SPECIFICATIONS

Inch			Metric			Code No.
Range	Resolution	Accuracy	Range	Resolution	Accuracy	
.12-5"	.0005"	±.001"	3-125mm	0.01mm	±0.03mm	325-05-0
.12-8"	.0005"	±.001"	3-200mm	0.01mm	±0.03mm	325-08-0
.16-12"	.0005"	±.0015"	4-300mm	0.01mm	±0.04mm	325-12-0

STANDARD ACCESSORIES

- Battery
- Warranty card, Instruction manual, Calibration certificate

Dimension

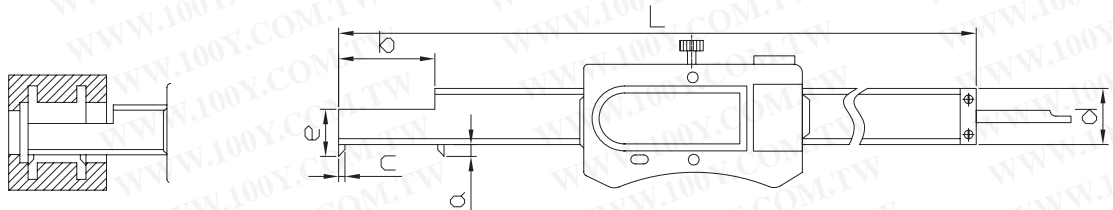

Range	L	a	b	c	d	e
Inch/Metric	mm	mm	mm	mm	mm	mm
.12-6"/3-125mm	235	4	24	3	12.5	12
.12-8"/3-200mm	310	4	24	3	12.5	12
.16-12"/4-300mm	466	5	86	4	15	14

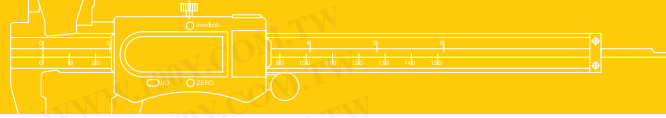

Dial Calipers

303 / 304 / 308 Series

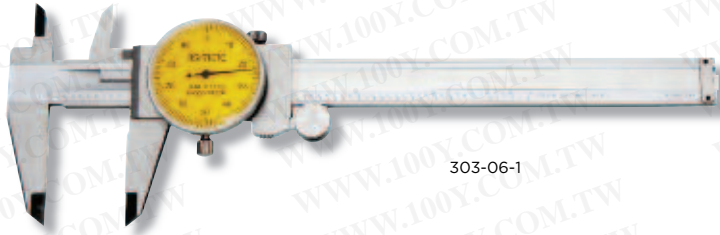

303-06-1



304-06-6



304-56-4

FEATURES

- Graduation:
Inch: .001"
Metric: 0.01mm or 0.02mm
- Stainless steel construction with all measuring surfaces surface-hardened
- Preloaded dual pinions eliminate backlash and provide better repeatability
- Thumb roller included

Aluminum models

- Sturdy Aluminum ergonomic diecast housing can be used without damage in the harshest of manufacturing environments, including situations with hot steel chips
- The dual pinion mechanism offers extra smooth operation

Carbide tipped measuring faces models

- Both ID & OD measuring surfaces are carbide tipped to increase caliper life by preventing wear

STANDARD ACCESSORIES

- Warranty card, Instruction manual, Calibration certificate

SPECIFICATIONS

Inch		
Range	Accuracy	Code No.
Standard models		
0-6"	±.001"	303-06-1
0-8"	±.0015"	303-08-1
0-12"	±.0015"	303-12-1
Aluminum dial housing models		
0-6"	±.001"	304-06-5
0-8"	±.0015"	304-08-5
0-12"	±.0015"	304-12-5
Carbide Tip models		
0-6"	±.001"	308-06-3
0-8"	±.0015"	308-08-3
0-12"	±.0015"	308-12-3

Metric		Grad.: 0.01mm	Grad.: 0.02mm
Range	Accuracy	Code No.	Code No.
Standard models			
0-150mm	±0.02mm	303-06-0	303-06-2
0-200mm	±0.03mm	303-08-0	303-08-2
0-300mm	±0.04mm	303-12-0	303-12-2
Aluminum dial housing models			
0-150mm	±0.02mm	304-06-4	304-06-6
0-200mm	±0.03mm	304-08-4	304-08-6
0-300mm	±0.04mm	304-12-4	304-12-6
Carbide Tip models			
0-150mm	±0.02mm	308-06-2	-
0-200mm	±0.03mm	308-08-2	-
0-300mm	±0.04mm	308-12-2	-
Plastic case models			
0-150mm	±0.02mm	304-56-4	-
0-200mm	±0.03mm	304-58-4	-

Dimension

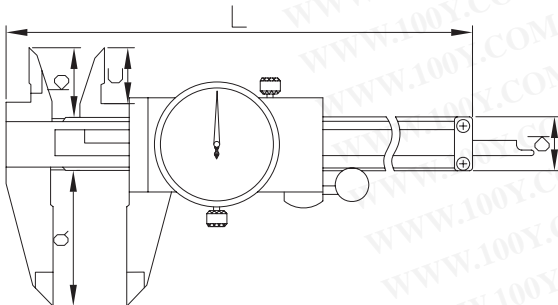

Range	L	a	b	c	d
Inch/Metric	mm	mm	mm	mm	mm
0-6"/0-150mm	234	40	21	16.5	16
0-8"/0-200mm	290	50	23.5	19	17
0-12"/0-300mm	393	64	24.5	20	17

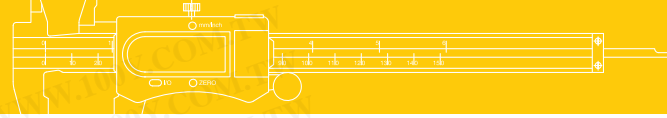

Vernier Calipers

341 / 343 Series

Plain

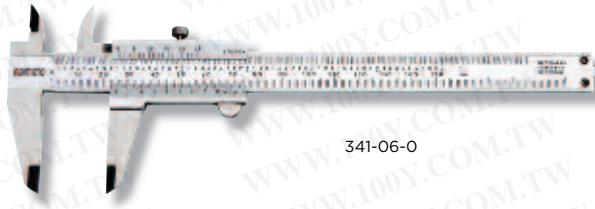

341-06-0

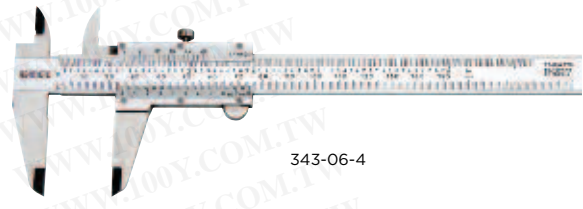

343-06-4

FEATURES

- Graduation:
Inch: .001"
Metric: 0.02mm or 0.05mm
- Various models available with an assortment of dual scales
- Measuring surfaces allow for the measurement of external diameters, internal diameters, depths and steps

- The upper and lower scales on the slider are angled to reduce parallax error
- Stainless steel with surface hardened measuring faces
- Models are available with the slider operation in either plain, thumb clamp, fine adjustment

STANDARD ACCESSORIES

- Warranty card, Instruction manual, Calibration certificate

SPECIFICATIONS

Range	Graduation	Range	Graduation	Accuracy	Note	Code No.
Lower	Lower	Upper	Upper			
Mono Block						
0-6"	.001"	0-6"	1/128"	±.001"	upper lock	341-06-1
0-8"	.001"	0-8"	1/128"	±.001"	upper lock	341-08-1
0-150mm	0.05mm	0-6"	1/128"	±0.05mm	upper lock	341-06-0
0-150mm	0.05mm	0-6"	1/128"	±0.05mm	lower locking screw	341-66-0
0-200mm	0.05mm	0-8"	1/128"	±0.05mm	upper lock	341-08-0
0-300mm	0.05mm	0-12"	1/128"	±0.05mm	upper lock	341-12-0
0-150mm	0.05mm	0-6"	1/128"	±0.05mm	with round depth bar Φ 1.8mm	341-06-2
0-100mm	0.02mm	0-4"	0.001"	±0.02mm	upper lock	341-04-4
0-150mm	0.02mm	0-6"	0.001"	±0.02mm	upper lock	341-06-4
0-200mm	0.02mm	0-8"	0.001"	±0.03mm	upper lock	341-08-4
0-300mm	0.02mm	0-12"	0.001"	±0.04mm	upper lock	341-12-4
0-150mm	0.05mm	0-6"	1/128"	±0.05mm	Titanium coating	341-06-6
0-200mm	0.05mm	0-8"	1/128"	±0.05mm	Titanium coating	341-08-6
0-300mm	0.05mm	0-12"	1/128"	±0.05mm	Titanium coating	341-12-6
0-150mm	0.02mm	0-6"	0.001"	±0.02mm	Titanium coating	341-06-8
0-200mm	0.02mm	0-8"	0.001"	±0.03mm	Titanium coating	341-08-8
0-300mm	0.02mm	0-12"	0.001"	±0.04mm	Titanium coating	341-12-8
Open Block						
0-100mm	0.02mm	-	-	±0.02mm	upper lock	343-04-4
0-150mm	0.02mm	-	-	±0.02mm	upper lock	343-06-4
0-200mm	0.02mm	-	-	±0.03mm	upper lock	343-08-4
0-300mm	0.02mm	-	-	±0.04mm	upper lock	343-12-4

Dimension

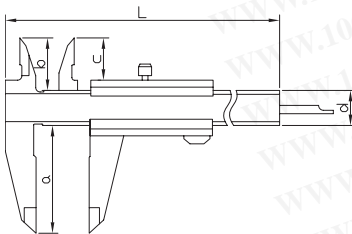

Range	L	a	b	c	d
Inch/Metric	mm	mm	mm	mm	mm
0-4"/0-100mm	175	25	19	13.5	16
0-6"/0-150mm	235	40	21	16.5	16
0-8"/0-200mm	297	50	23.5	19	16
0-12"/0-300mm	410	64	27	22	20

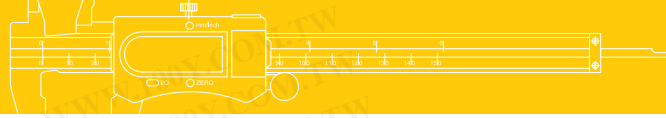

Vernier Calipers

363 Series

Fine adjustment

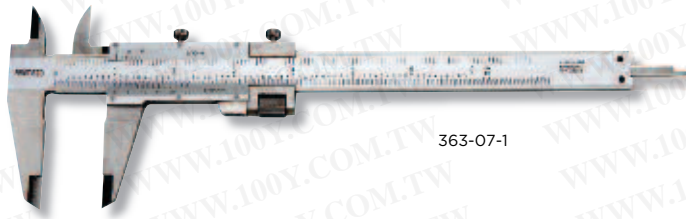

363-07-1

SPECIFICATIONS

Range	Graduation	Range	Graduation	Accuracy	Note	Open Block
Lower	Lower	Upper	Upper			Code No.
Inch						
0-5"	.001"	0-5"	1/128"	±0.001"	upper lock	363-05-1
0-7"	.001"	0-7"	1/128"	±0.0015"	upper lock	363-07-1
0-11"	.001"	0-11"	1/128"	±0.0015"	upper lock	363-11-1
Metric						
0-130mm	0.02mm	0-5"	0.001"	±0.02mm	upper lock	363-05-6
0-180mm	0.02mm	0-7"	0.001"	±0.03mm	upper lock	363-07-6
0-280mm	0.02mm	0-11"	0.001"	±0.04mm	upper lock	363-11-6

Dimension

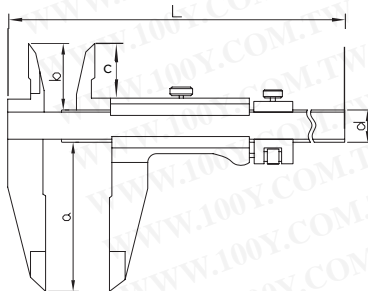

Range	L	a	b	c	d
Inch/Metric	mm	mm	mm	mm	mm
0-5.2"/0-130mm	228	40	21	16.5	16
0-7.2"/0-180mm	290	50	23.5	19	17
0-11.2/0-280mm	410	64	27.5	22	20

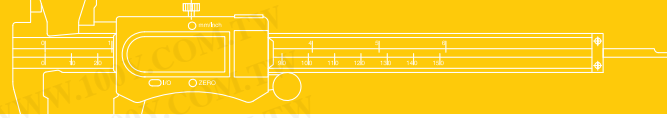

Vernier Calipers

351 / 302 Series

Thumb Clamp



351-06-4

Dimension

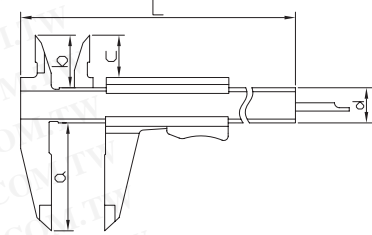

Range	L	a	b	c	d
Inch/Metric	mm	mm	mm	mm	mm
0-6"/0-150mm	228	40	21	16.5	16
0-8"/0-200mm	290	50	23.5	19	17

SPECIFICATIONS

Range	Graduation	Range	Graduation	Accuracy	Note	Code No.
Lower	Lower	Upper	Upper			
0-6"	.001"	0-6"	1/128"	±.001"	-	351-06-1
0-8"	.001"	0-8"	1/128"	±.0015"	-	351-08-1
0-150mm	0.05mm	0-6"	1/128"	±0.05mm	-	351-06-0
0-200mm	0.05mm	0-8"	1/128"	±0.05mm	-	351-08-0
0-150mm	0.05mm	0-6"	1/128"	±0.05mm	with round depth bar Φ 1.8mm	351-06-2
0-150mm	0.02mm	0-6"	0.001"	±0.02mm	-	351-06-4
0-200mm	0.02mm	0-8"	0.001"	±0.03mm	-	351-08-4

Modified "V" type beam

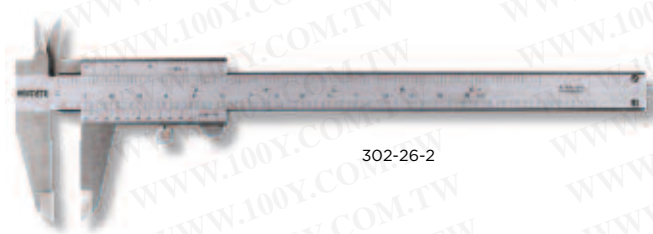

302-26-2

Dimension

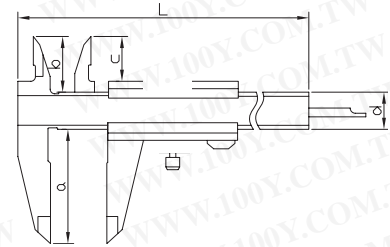

Range	L	a	b	c	d
Inch/Metric	mm	mm	mm	mm	mm
0-6"/0-150mm	235	40	21	16.5	16

FEATURES

- Designed with increased repeatability by incorporating a "V" slider to beam technology

SPECIFICATIONS

Range	Graduation	Range	Graduation	Accuracy	Note	Code No.
Lower	Lower	Upper	Upper			
0-150mm	0-6"	0.05mm	1/128"	±0.05mm	lower locking screw	302-26-0
0-150mm	0-6"	0.02mm	.001"	±0.02mm	lower locking screw	302-26-2

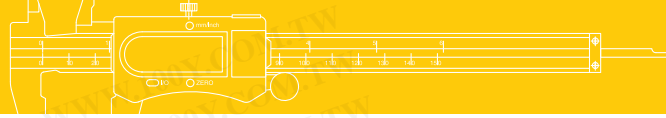

Long Jaw Vernier Calipers (Mono block)

311 Series



311-20-4

FEATURES

- Graduation:
Inch: .001"
Metric: 0.02mm or 0.05mm
- Stainless steel
- Models available with an assortment of Metric/Inch scale configurations
- Designed with fine adjustment to allow precise movement of the slider
- Internal measurement jaws are rounded to provide accurate measurement of internal diameters
- Minimum internal diameter measurement capability of:
10mm for 300mm/12" range
20mm for over 450mm/18" range

STANDARD ACCESSORIES

- Warranty card, Instruction manual,
Calibration certificate

SPECIFICATIONS

Range	Graduation	Range	Graduation	Accuracy	Jaw Length	Code No.
Lower	Lower	Upper	Upper			
0-12"	.001"	0-300mm	0.02mm	±.0015"	90mm	311-12-3
0-20"	.001"	0-500mm	0.02mm	±.0020"	200mm	311-20-3
0-30"	.001"	0-750mm	0.02mm	±.0020"	200mm	311-30-3
0-40"	.001"	0-1000mm	0.02mm	±.0030"	200mm	311-40-3
0-300mm	0.02mm	0-12"	.001"	±0.04mm	90mm	311-12-4
0-500mm	0.02mm	0-20"	.001"	±0.05mm	200mm	311-20-4
0-750mm	0.02mm	0-30"	.001"	±0.07mm	200mm	311-30-4
0-1000mm	0.02mm	0-40"	.001"	±0.07mm	200mm	311-40-4
0-300mm	0.05mm	0-12"	1/128"	±0.05mm	90mm	311-12-6
0-500mm	0.05mm	0-20"	1/128"	±0.08mm	200mm	311-20-6
0-750mm	0.05mm	0-30"	1/128"	±0.10mm	200mm	311-30-6
0-1000mm	0.05mm	0-40"	1/128"	±0.10mm	200mm	311-40-6

Dimension

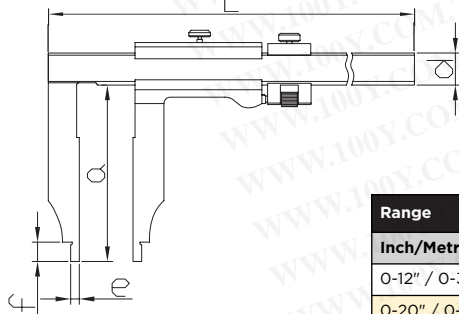

Range	L	a	d	e	f
Inch/Metric	mm	mm	mm	mm	mm
0-12" / 0-300mm	450	90	20	5	12
0-20" / 0-500mm	735	200	30	10	23
0-30" / 0-750mm	985	200	32	10	25
0-40" / 0-1000mm	1235	200	32	10	25

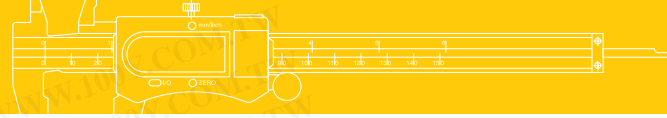

Long Jaw Vernier Calipers (Open block) 311 Series



FEATURES

- Graduation:
Inch: .001"
Metric: 0.02mm
- Stainless steel
- Models available with an assortment of Metric/Inch scale configurations
- Designed with fine adjustment to allow precise movement of the slider
- Internal measurement jaws are rounded to provide accurate measurement of internal diameters
- Minimum internal diameter measurement capability of:
10mm for 300mm/12" range
20mm for over 450mm/18" range

STANDARD ACCESSORIES

- Warranty card, Instruction manual,
Calibration certificate

SPECIFICATIONS

Range	Graduation	Range	Graduation	Accuracy	Jaw Length	Code No.
Lower	Lower	Upper	Upper			
0-12"	.001"	0-300mm	0.02mm	±.0015"	90mm	313-12-3
0-20"	.001"	0-500mm	0.02mm	±.0020"	200mm	313-20-3
0-30"	.001"	0-750mm	0.02mm	±.0020"	200mm	313-30-3
0-40"	.001"	0-1000mm	0.02mm	±.0030"	200mm	313-40-3
0-300mm	0.02mm	0-12"	.001"	±0.04mm	90mm	313-12-4
0-500mm	0.02mm	0-20"	.001"	±0.05mm	200mm	313-20-4
0-750mm	0.02mm	0-30"	.001"	±0.07mm	200mm	313-30-4
0-1000mm	0.02mm	0-40"	.001"	±0.07mm	200mm	313-40-4

Dimension

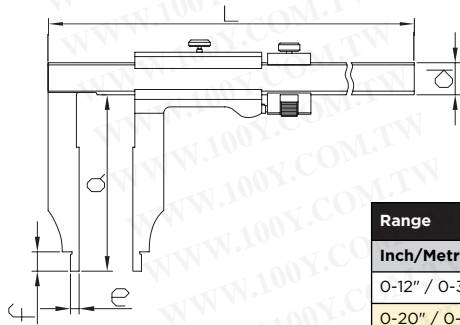

Range	L	a	d	e	f
Inch/Metric	mm	mm	mm	mm	mm
0-12" / 0-300mm	450	90	20	5	12
0-20" / 0-500mm	735	200	30	10	23
0-30" / 0-750mm	985	200	32	10	25
0-40" / 0-1000mm	1235	200	32	10	25

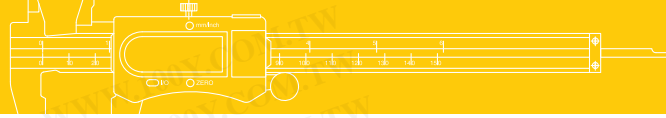

Heavy Duty Vernier Calipers With Upper Knife-edge (Mono block) 302 Series



302-12-2

STANDARD ACCESSORIES

- Warranty card, Instruction manual, Calibration certificate

FEATURES

- Graduation:
Inch: .001"
Metric: 0.02mm or 0.05mm
- With upper knife-edge for external diameter measurement
- Designed with fine adjustment to allow precise movement of the slider
- Stainless steel
- Models available with an assortment of Metric/Inch scale configurations
- Internal measurement jaws are rounded to provide accurate measurement of internal diameters with minimum internal measuring capability of 20mm

SPECIFICATIONS

Range	Graduation	Range	Graduation	Accuracy	Jaw Length	Code No.
Lower	Lower	Upper	Upper			
0-12"	.001"	0-300mm	0.02mm	±.0015"	56mm+100mm	302-12-1
0-20"	.001"	0-500mm	0.02mm	±.0020"	67mm+150mm	302-20-1
0-32"	.001"	0-800mm	0.02mm	±.0020"	67mm+150mm	302-32-1
0-40"	.001"	0-1000mm	0.02mm	±.0030"	67mm+150mm	302-40-1
0-300mm	0.02mm	0-12"	.001"	±0.04mm	56mm+100mm	302-12-0
0-500mm	0.02mm	0-20"	.001"	±0.05mm	67mm+150mm	302-20-0
0-800mm	0.02mm	0-32"	.001"	±0.07mm	67mm+150mm	302-32-0
0-1000mm	0.02mm	0-40"	.001"	±0.07mm	67mm+150mm	302-40-0
0-300mm	0.05mm	0-12"	1/128"	±0.08mm	56mm+100mm	302-12-2
0-500mm	0.05mm	0-20"	1/128"	±0.08mm	67mm+150mm	302-20-2
0-800mm	0.05mm	0-32"	1/128"	±0.10mm	67mm+150mm	302-32-2
0-1000mm	0.05mm	0-40"	1/128"	±0.10mm	67mm+150mm	302-40-2

Remark: Special Jaw Length are upon requested

Dimension

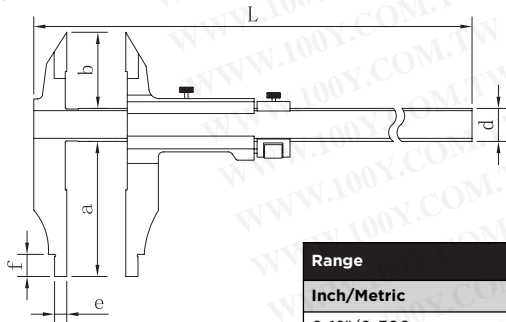

Range	L	a	b	d	e	f
Inch/Metric	mm	mm	mm	mm	mm	mm
0-12"/0-300mm	470	100	56	25	10	18
0-20"/0-500mm	735	150	67	32	10	25
0-32"/0-800mm	1035	150	67	32	10	25

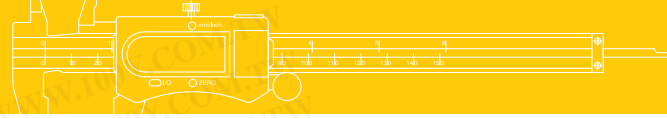

Heavy Duty Vernier Calipers With Upper Knife-edge (Open block) 302 Series

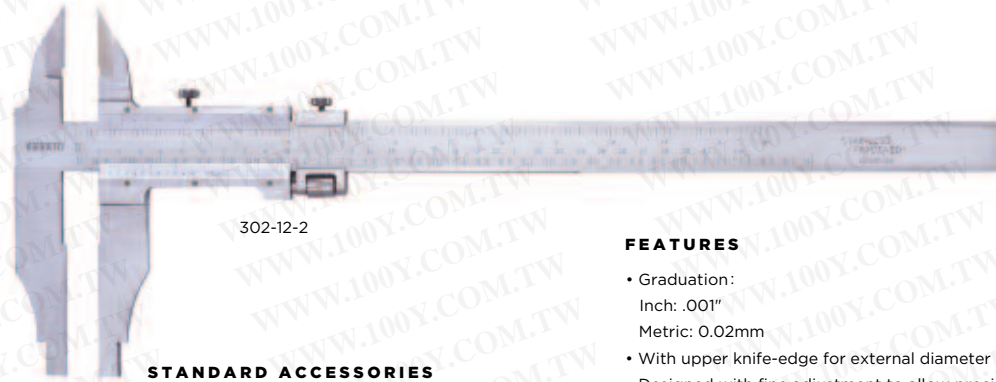

302-12-2

STANDARD ACCESSORIES

- Warranty card, Instruction manual, Calibration certificate

FEATURES

- Graduation:
Inch: .001"
Metric: 0.02mm
- With upper knife-edge for external diameter measurement
- Designed with fine adjustment to allow precise movement of the slider
- Stainless steel
- Models available with an assortment of Metric/Inch scale configurations
- Internal measurement jaws are rounded to provide accurate measurement of internal diameters with minimum internal measuring capability of 20mm

SPECIFICATIONS

Range	Graduation	Range	Graduation	Accuracy	Jaw Length	Code No.
Lower	Lower	Upper	Upper			
0-12"	.001"	0-300mm	0.02mm	±.0015"	36.5mm+90mm	302-12-9
0-20"	.001"	0-500mm	0.02mm	±.0020"	55mm+150mm	302-20-9
0-32"	.001"	0-800mm	0.02mm	±.0020"	64mm+150mm	302-32-9
0-40"	.001"	0-1000mm	0.02mm	±.0030"	64mm+150mm	302-40-9
0-300mm	0.02mm	0-12"	.001"	±0.04mm	36.5mm+90mm	302-12-8
0-500mm	0.02mm	0-20"	.001"	±0.05mm	55mm+150mm	302-20-8
0-800mm	0.02mm	0-32"	.001"	±0.07mm	64mm+150mm	302-32-8
0-1000mm	0.02mm	0-40"	.001"	±0.07mm	64mm+150mm	302-40-8

Remark: Special Jaw Length are upon requested

Dimension

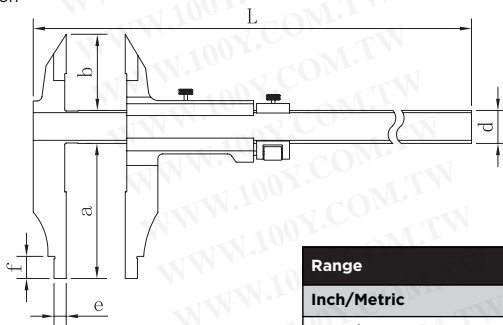

Range	L	a	b	d	e	f
Inch/Metric	mm	mm	mm	mm	mm	mm
0-12"/0-300mm	470	100	56	25	10	18
0-20"/0-500mm	735	150	67	32	10	25
0-32"/0-800mm	1035	150	67	32	10	25

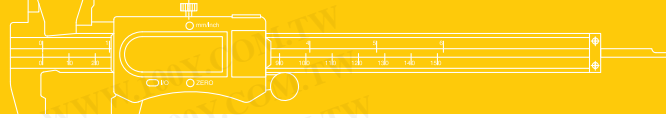

Heavy Duty Vernier Calipers (Mono block)

311 Series

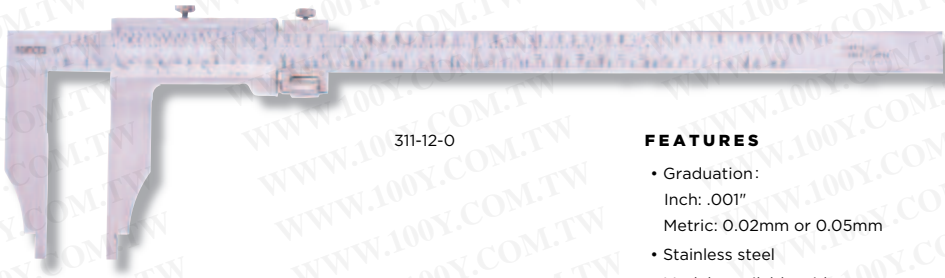

311-12-0

FEATURES

- Graduation:
Inch: .001"
Metric: 0.02mm or 0.05mm
- Stainless steel
- Models available with an assortment of Metric/Inch scale configurations
- Designed with fine adjustment to allow precise movement of the slider
- Internal measurement jaws are rounded to provide accurate measurement of internal diameters
- Minimum internal diameter measurement capability of:
10mm for 300mm/12" range
20mm for over 450mm/18" range

STANDARD ACCESSORIES

- Warranty card, Instruction manual, Calibration certificate

SPECIFICATIONS

Range	Graduation	Range	Graduation	Accuracy	Jaw Length	Code No.
Lower	Lower	Upper	Upper			
0-12"	.001"	0-300mm	0.02mm	±0.015"	75mm	311-12-1
0-18"	.001"	0-450mm	0.02mm	±0.020"	100mm	311-18-1
0-20"	.001"	0-500mm	0.02mm	±0.020"	100mm	311-20-1
0-24"	.001"	0-600mm	0.02mm	±0.020"	100mm	311-24-1
0-32"	.001"	0-800mm	0.02mm	±0.020"	150mm	311-32-1
0-40"	.001"	0-1000mm	0.02mm	±0.030"	150mm	311-40-1
0-60"	.001"	0-1500mm	0.02mm	±0.040"	200mm	311-60-1
0-80"	.001"	0-2000mm	0.02mm	±0.050"	200mm	311-80-1
0-300mm	0.02mm	0-12"	.001"	±0.04mm	75mm	311-12-0
0-450mm	0.02mm	0-18"	.001"	±0.05mm	100mm	311-18-0
0-500mm	0.02mm	0-20"	.001"	±0.05mm	100mm	311-20-0
0-600mm	0.02mm	0-24"	.001"	±0.05mm	100mm	311-24-0
0-800mm	0.02mm	0-32"	.001"	±0.05mm	150mm	311-32-0
0-1000mm	0.02mm	0-40"	.001"	±0.07mm	150mm	311-40-0
0-1500mm	0.02mm	0-60"	.001"	±0.11mm	200mm	311-60-0
0-2000mm	0.02mm	0-80"	.001"	±0.14mm	200mm	311-80-0
0-300mm	0.05mm	0-12"	1/128"	±0.05mm	75mm	311-12-2
0-450mm	0.05mm	0-18"	1/128"	±0.08mm	100mm	311-18-2
0-500mm	0.05mm	0-20"	1/128"	±0.05mm	100mm	311-20-2
0-600mm	0.05mm	0-24"	1/128"	±0.10mm	100mm	311-24-2
0-800mm	0.05mm	0-32"	1/128"	±0.10mm	150mm	311-32-2
0-1000mm	0.05mm	0-40"	1/128"	±0.10mm	150mm	311-40-2
0-1500mm	0.05mm	0-60"	1/128"	±0.15mm	200mm	311-60-2
0-2000mm	0.05mm	0-80"	1/128"	±0.20mm	200mm	311-80-2

Remark: Special Jaw Length are upon requested

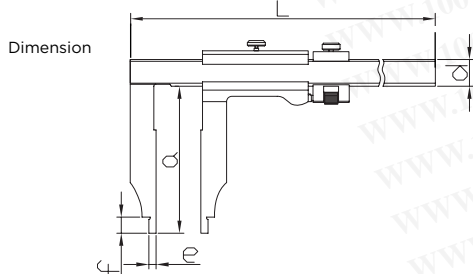

Range	L	a	d	e	f
Inch/Metric	mm	mm	mm	mm	mm
0-12" / 0-300mm	450	75	20	5	12
0-18" / 0-450mm	685	100	25	10	25
0-20" / 0-500mm	735	100	25	10	25
0-24" / 0-600mm	835	100	32	10	25
0-32" / 0-800mm	1035	150	32	10	25
0-40" / 0-1000mm	1235	150	32	10	25
0-60" / 0-1500mm	1820	200	42	10	25
0-80" / 0-2000mm	2270	200	42	10	25

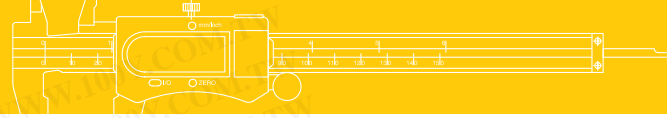

Heavy Duty Vernier Calipers (Open block) 311 Series

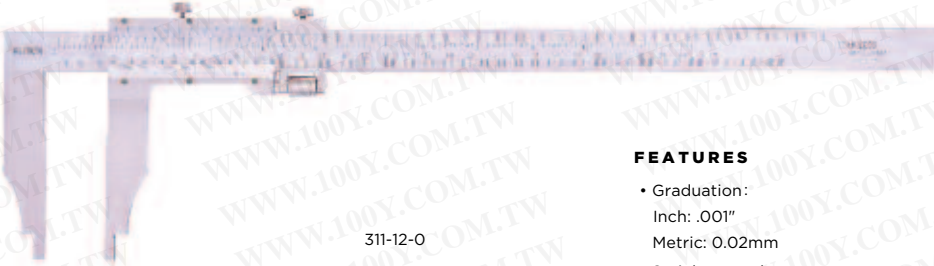

311-12-0

STANDARD ACCESSORIES

- Warranty card, Instruction manual, Calibration certificate

FEATURES

- Graduation:
Inch: .001"
Metric: 0.02mm
- Stainless steel
- Models available with an assortment of Metric/Inch scale configurations
- Designed with fine adjustment to allow precise movement of the slider
- Internal measurement jaws are rounded to provide accurate measurement of internal diameters
- Minimum internal diameter measurement capability of:
10mm for 300mm/12" range
20mm for over 450mm/18" range

SPECIFICATIONS

Range	Graduation	Range	Graduation	Accuracy	Jaw Length	Code No.
Lower	Lower	Upper	Upper			
0-12"	.001"	0-300mm	0.02mm	±0.015"	75mm	313-12-1
0-18"	.001"	0-450mm	0.02mm	±0.020"	100mm	313-18-1
0-20"	.001"	0-500mm	0.02mm	±0.020"	100mm	313-20-1
0-24"	.001"	0-600mm	0.02mm	±0.020"	100mm	313-24-1
0-32"	.001"	0-800mm	0.02mm	±0.020"	150mm	313-32-1
0-40"	.001"	0-1000mm	0.02mm	±0.030"	150mm	313-40-1
0-60"	.001"	0-1500mm	0.02mm	±0.040"	200mm	313-60-1
0-80"	.001"	0-2000mm	0.02mm	±0.050"	200mm	313-80-1
0-300mm	0.02mm	0-12"	.001"	±0.04mm	75mm	313-12-0
0-450mm	0.02mm	0-18"	.001"	±0.05mm	100mm	313-18-0
0-500mm	0.02mm	0-20"	.001"	±0.05mm	100mm	313-20-0
0-600mm	0.02mm	0-24"	.001"	±0.05mm	100mm	313-24-0
0-800mm	0.02mm	0-32"	.001"	±0.05mm	150mm	313-32-0
0-1000mm	0.02mm	0-40"	.001"	±0.07mm	150mm	313-40-0
0-1500mm	0.02mm	0-60"	.001"	±0.11mm	200mm	313-60-0
0-2000mm	0.02mm	0-80"	.001"	±0.14mm	200mm	313-80-0

Remark: Special Jaw Length are upon requested

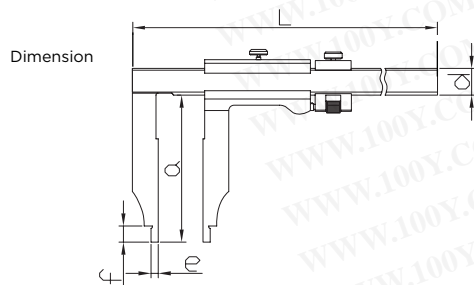

Range	L	a	d	e	f
Inch/Metric	mm	mm	mm	mm	mm
0-12" / 0-300mm	450	75	20	5	12
0-18" / 0-450mm	685	100	25	10	25
0-20" / 0-500mm	735	100	25	10	25
0-24" / 0-600mm	835	100	32	10	25
0-32" / 0-800mm	1035	150	32	10	25
0-40" / 0-1000mm	1235	150	32	10	25
0-60" / 0-1500mm	1820	200	42	10	25
0-80" / 0-2000mm	2270	200	42	10	25

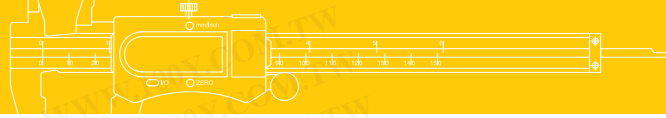

Circle Vernier Calipers

322 Series

FEATURES

- Graduation: 0.1mm
- With one-piece slider
- Made with stainless steel, hardened measuring face

STANDARD ACCESSORIES

- Warranty card

SPECIFICATIONS

Range	Accuracy	Jaw length	Code No.
0-150mm	±0.2mm	40mm	322-71-0
0-200mm	±0.2mm	40mm	322-72-0
0-250mm	±0.3mm	40mm	322-73-0
0-300mm	±0.3mm	40mm	322-74-0



T Form Marking Calipers

FEATURES

- Graduation: 0.05mm
- Made with stainless steel

STANDARD ACCESSORIES

- Warranty card

SPECIFICATIONS

Range	Accuracy	Base Length	Code No.
0-160mm	±0.1mm	135mm	322-51-0
0-250mm	±0.1mm	135mm	322-52-0
0-300mm	±0.15mm	160mm	322-53-0

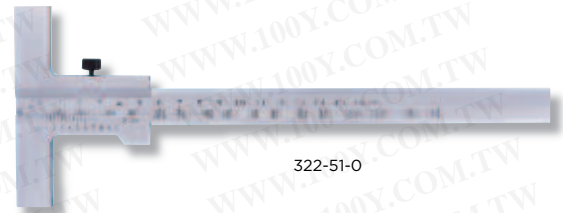

Marking Calipers

FEATURES

- Graduation: 1/128" / 0.1mm
- Made with stainless steel

STANDARD ACCESSORIES

- Warranty card

SPECIFICATIONS

Range		Range		Code No.
Upper	Accuracy	Lower	Accuracy	
0-8"	±.02"	0-200mm	±0.2mm	322-61-0
0-16"	±.02"	0-400mm	±0.3mm	322-62-0



322-61-0

Measuring Gauges

FEATURES

- Graduation: 0.1mm
- Made with stainless steel

STANDARD ACCESSORIES

- Warranty card

SPECIFICATIONS

Range	Accuracy	Code No.
0-200mm	±0.2mm	322-81-0
0-250mm	±0.3mm	322-82-0
0-300mm	±0.3mm	322-83-0



322-81-0

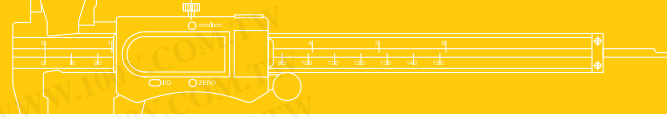

Forester Calipers

322 Series



FEATURES

- Made of Aluminium, Plastic handle

SPECIFICATIONS

Range	Graduation	Jaw Length	Code No.
0-500mm	5mm	255mm	322-91-0
0-800mm	5mm	410mm	322-92-0
0-1000mm	5mm	410mm	322-93-0

Internal Dial Caliper Gauges

403 Series

FEATURES

- Graduation: .001" / 0.025mm.
- For checking internal bores, recess diameters, etc.
- Highly recommended for quick ID comparisons.
- Gauge has a movement of 1" (25 mm).
- Can be set with a micrometer or ring gauge.
- Bezel rotates for zero setting.
- Button for closing arms. Arms automatically open when button is released.
- Unit is spring-loaded and makes point contact at constant measuring pressure.
- Arms have 0.06" diameter measuring tips.
- Revolution counter.
- Leg length 3-1/4".

STANDARD ACCESSORIES

- S-wrench
- Warranty card, Calibration certificate

SPECIFICATIONS

Inch		Metric		Inch		Metric	
Range	Accuracy	Range	Accuracy	Code No.	Code No.		
0.375 - 1.375"	±.002"	10-35mm	±0.05mm	403-31-1	403-31-0		
0.750 - 1.750"	±.002"	20-45mm	±0.05mm	403-32-1	403-32-0		
1.125 - 2.125"	±.002"	30-55mm	±0.05mm	403-33-1	403-33-0		
1.500 - 2.500"	±.002"	40-65mm	±0.05mm	403-34-1	403-34-0		
1.875 - 2.875"	±.003"	50-75mm	±0.08mm	403-35-1	403-35-0		
2.250 - 3.250"	±.003"	60-85mm	±0.08mm	403-36-1	403-36-0		
2.875 - 3.875"	±.003"	75-100mm	±0.08mm	403-37-1	403-37-0		
3.250 - 4.250"	±.004"	85-110mm	±0.08mm	403-38-1	403-38-0		
-	-	95-120mm	±0.1mm	-	403-39-0		
-	-	100-125mm	±0.1mm	-	403-40-0		



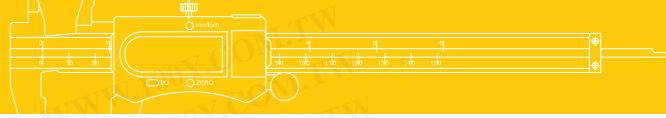

Internal Caliper Gauges

400 / 403 Series



400-14-0



403-22-0

FEATURES

- Resolution:
Digital models: .0002" / 0.005mm; Dial models: .0005" / 0.01mm
- Designed to measure internal grooves, and other intricate detailed internal characteristics
- This measuring instrument provides comparison readings and must be set to the nominal dimension using either micrometer or Setting Ring
- The digital model allows the display housing to be rotated $\pm 170^\circ$

STANDARD ACCESSORIES

- Battery (Digital models)
- Warranty card, Instruction manual, Calibration certificate

SPECIFICATIONS

Range	Arm Length	Tipped Length	Accuracy	Dial models	Digital models
				Type A Code No.	Type A Code No.
Inch					
.2-.6"	20mm	1.5mm	$\pm 0.008"$	403-11-1	400-11-1
.4-.8"	25mm	3.0mm	$\pm 0.008"$	403-12-1	400-12-1
.8-1.2"	30mm	6.5mm	$\pm 0.008"$	403-13-1	400-13-1
1.2-1.6"	30mm	9.0mm	$\pm 0.008"$	403-14-1	400-14-1
1.6-2.0"	30mm	9.0mm	$\pm 0.008"$	403-15-1	400-15-1
.2-1.0"	35mm	1.5mm	$\pm 0.0012"$	403-21-1	400-21-1
.4-1.2"	55mm	3.5mm	$\pm 0.0012"$	403-22-1	400-22-1
.8-1.6"	80mm	6.5mm	$\pm 0.0012"$	403-23-1	400-23-1
1.2-2.0"	80mm	8.5mm	$\pm 0.0012"$	403-24-1	400-24-1
1.6-2.4"	80mm	8.5mm	$\pm 0.0012"$	403-25-1	400-25-1
Metric					
5-15mm	20mm	1.5mm	± 0.02 mm	403-11-0	400-11-0
10-20mm	25mm	3.0mm	± 0.02 mm	403-12-0	400-12-0
20-30mm	30mm	6.5mm	± 0.02 mm	403-13-0	400-13-0
30-40mm	30mm	9.0mm	± 0.02 mm	403-14-0	400-14-0
40-50mm	30mm	9.0mm	± 0.02 mm	403-15-0	400-15-0
5-25mm	35mm	1.5mm	± 0.03 mm	403-21-0	400-21-0
10-30mm	55mm	3.5mm	± 0.03 mm	403-22-0	400-22-0
20-40mm	80mm	6.5mm	± 0.03 mm	403-23-0	400-23-0
30-50mm	80mm	8.5mm	± 0.03 mm	403-24-0	400-24-0
40-60mm	80mm	8.5mm </td <td>± 0.03mm</td> <td>403-25-0</td> <td>400-25-0</td>	± 0.03 mm	403-25-0	400-25-0

Dimension

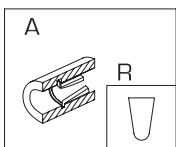
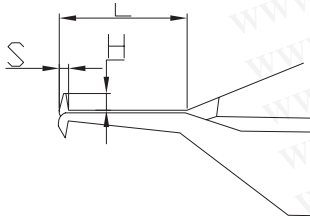

Metric	Inch	L	S	H	Measuring contact A(R)
Range	Range				
5-15mm	.2-.6"	20mm	1.0mm	1.5mm	0.3mm
10-20mm	.4-.8"	25mm	1.5mm	3.0mm	0.3mm
20-30mm	.8-1.2"	30mm	2.0mm	6.5mm	0.5mm
30-40mm	1.2-1.6"	30mm	2.5mm	9.0mm	0.5mm
40-50mm	1.6-2.0"	30mm	2.5mm	9.0mm	0.5mm
5-25mm	.2-1.0"	35mm	1.0mm	1.5mm	0.3mm
10-30mm	.4-1.2"	55mm	2.0mm	3.5mm	0.5mm
20-40mm	.8-1.6"	80mm	3.0mm	6.5mm	0.5mm
30-50mm	1.2-2.0"	80mm	3.0mm	8.5mm	0.5mm
40-60mm	1.6-2.4"	80mm	3.0mm	8.5mm	0.5mm

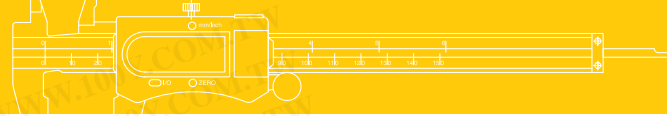

External Caliper Gauges

404 / 405 Series



404-21-0

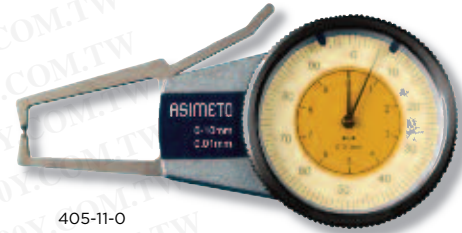

405-11-0

FEATURES

- Resolution:
Digital models: .0002" / 0.005mm; Dial models: .0005" / 0.01mm
- Designed to measure hard to access external work piece characteristics
- This measuring instrument provides comparison readings and must be set to the nominal dimension using either gauge blocks or an external setting master
The digital model allows the display housing to be rotated $\pm 170^\circ$

STANDARD ACCESSORIES

- Battery (Digital models)
- Warranty card, Instruction manual, Calibration certificate

SPECIFICATIONS

Range	Arm Length	Tipped Length	Accuracy	Dial models	Digital models
				Type A Code No.	Type A Code No.
Inch					
0-.4"	20mm	1.5mm	$\pm 0.008"$	405-11-1	404-11-1
.4-.8"	25mm	3.0mm	$\pm 0.008"$	405-12-1	404-12-1
.8-1.2"	30mm	6.5mm	$\pm 0.008"$	405-13-1	404-13-1
1.2-1.6"	30mm	9.0mm	$\pm 0.008"$	405-14-1	404-14-1
1.6-2.0"	30mm	9.0mm	$\pm 0.008"$	405-15-1	404-15-1
0-.8"	35mm	1.5mm	$\pm 0.0012"$	405-21-1	404-21-1
.4-1.2"	55mm	3.5mm	$\pm 0.0012"$	405-22-1	404-22-1
.8-1.6"	80mm	6.5mm	$\pm 0.0012"$	405-23-1	404-23-1
1.2-2.0"	80mm	8.5mm	$\pm 0.0012"$	405-24-1	404-24-1
1.6-2.4"	80mm	8.5mm	$\pm 0.0012"$	405-25-1	404-25-1
Metric					
0-10mm	20mm	1.5mm	$\pm 0.02\text{mm}$	405-11-0	404-11-0
10-20mm	25mm	3.0mm	$\pm 0.02\text{mm}$	405-12-0	404-12-0
20-30mm	30mm	6.5mm	$\pm 0.02\text{mm}$	405-13-0	404-13-0
30-40mm	30mm	9.0mm	$\pm 0.02\text{mm}$	405-14-0	404-14-0
40-50mm	30mm	9.0mm	$\pm 0.02\text{mm}$	405-15-0	404-15-0
0-20mm	35mm	1.5mm	$\pm 0.03\text{mm}$	405-21-0	404-21-0
10-30mm	55mm	3.5mm	$\pm 0.03\text{mm}$	405-22-0	404-22-0
20-40mm	80mm	6.5mm	$\pm 0.03\text{mm}$	405-23-0	404-23-0
30-50mm	80mm	8.5mm	$\pm 0.03\text{mm}$	405-24-0	404-24-0
40-60mm	80mm	8.5mm	$\pm 0.03\text{mm}$	405-25-0	404-25-0

Dimension

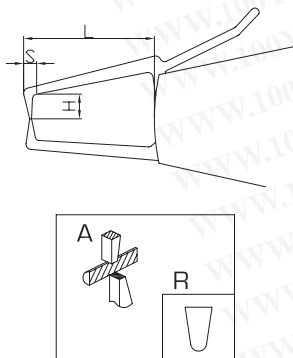

Metric	Inch	L	S	H	Measuring contact
Range	Range	L	S	H	A(R)
0-10mm	0-.8"	40mm	3mm	8mm	0.5mm
10-20mm	.4-.8"	40mm	3mm	8mm	0.5mm
20-30mm	.8-1.2"	40mm	3mm	8mm	0.5mm
30-40mm	1.2-1.6"	40mm	3mm	8mm	0.5mm
40-50mm	1.6-2.0"	40mm	3mm	8mm	0.5mm
0-20mm	0-.8"	80mm	6.5mm	25mm	0.75mm
10-30mm	.4-1.2"	80mm	6.5mm	25mm	0.75mm
20-40mm	.8-1.6"	80mm	6.5mm	25mm	0.75mm
30-50mm	1.2-2.0"	80mm	6.5mm	25mm	0.75mm
40-60mm	1.6-2.4"	80mm	6.5mm	25mm	0.75mm

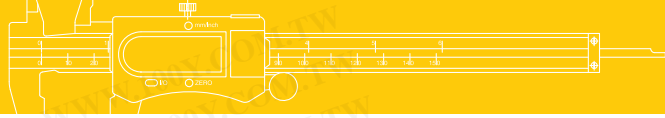

Caliper Extender Attachments

300 Series



300-01-0



300-01-1



300-01-4

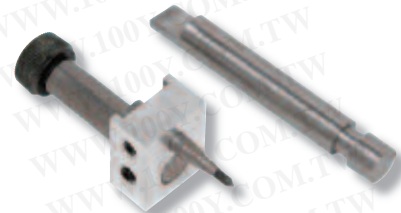

300-01-5

FEATURES

- A unique Caliper accessory that extends the range of your 6" Caliper up to 91"
- Allows both inside and outside measurements of up to 51" with your 6" Dial, Vernier, or Digital Caliper. These Extender Kits allow you to perform measuring operations without the expense of purchasing a stand alone Caliper, which could cost thousands of dollars! For the occasional measuring situation, these Kits provide the answer at a reasonable cost
- Extension bars are manufactured from high grade Aluminum, and black anodized with white numerals for clarity and protection
- The 91" model is clear anodized, with white numerals
- All mounting hardware and calibration rods are included
- Complete instructions accompany this easy to use kit. Choose the model that fits the range of measurements you need
- Caliper not included

SPECIFICATIONS

Description	Tolerance	Code No.
26" Extension Kit	±.003"	300-01-0
36" Extension Kit	±.003"	300-02-0
51" Extension Kit	±.004"	300-03-0
71" Extension Kit	±.005"	300-04-0
91" Extension Kit	±.006"	300-05-0
Accessory		
1/2" Projection Pins (pair)		300-01-1
1" Projection Pins (pair)		300-01-2
1-1/2" Projection Pins (pair)		300-01-3
Centerline Gauge Pins		300-01-4
Layout Kit		300-01-5

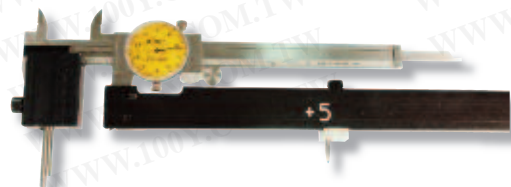
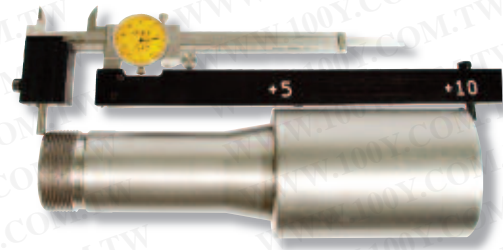

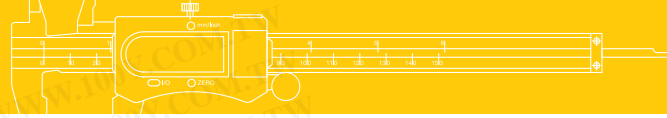

Universal Caliper Accessory Kits

300 Series

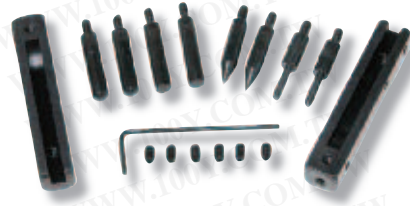
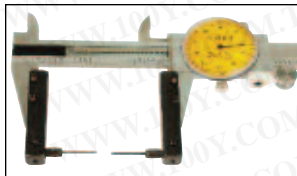
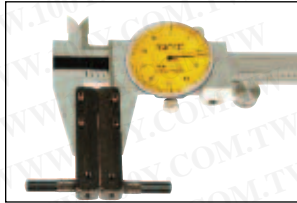
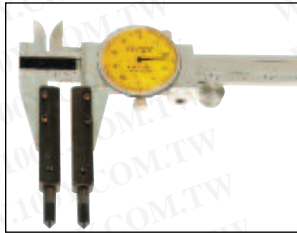
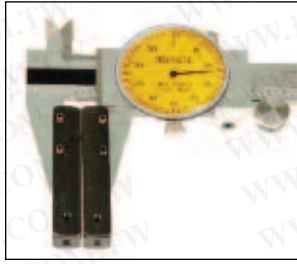

FEATURES

- The original caliper jaw attachment accessory
- The square bodies attach to the jaws of any 4", 6", 8" Caliper. Threaded holes are located in the front, both sides, and the bottoms of the bodies, allowing the use of the points on any side
- Measures slots, grooves, shoulders, holes, pockets, and takes ID and OD measurements
- Steel, Black Oxide finish

SPECIFICATIONS

Code No.: 300-11-0		
Kit contains:	QTY	Description
Universal Caliper Bodies	1 pair	3/8" square x 2" length. Slot for Caliper jaws is .147 wide. 4-40 holes for set screws fasten the body to the caliper jaw
Flat Points	1 pair	3/16 diameter x .810 length. 4-48 threads
Cone Points	1 pair	3/16 diameter x .810 length. 4-48 threads
Stem Points	1 pair	3/16 body diameter, .084 stem diameter x .820 length. 4-48 threads
Ball Points	1 pair	3/16 diameter x .810 length. 4-48 threads

Centerline Gauges

300 Series

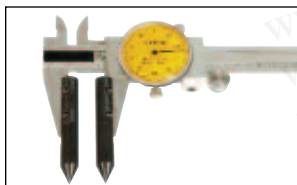
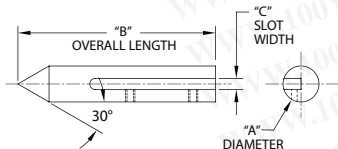

FEATURES

- Measures centerline distances
- Easily attaches to Dial, Vernier, and Digital Calipers
- 60 Degree Conical Points
- Hardened Steel with Black Oxide finish
- Attaches in seconds with Set Screws
- Supplied in High Impact Tubes with Allen Wrench
- User friendly instructions

SPECIFICATIONS

used	Min Measuring	A	B	C	Code No.
4", 6", and 8" Calipers	3/8"	.375"	2-5/16"	.127"	300-13-0
12" Calipers	1/2"	.500"	2.762"	.144"	300-14-0

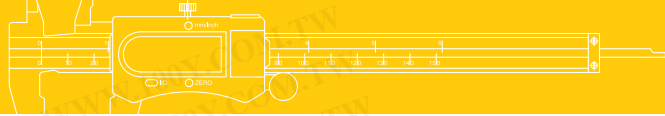

Groove Measurement Caliper Jaws

300 Series

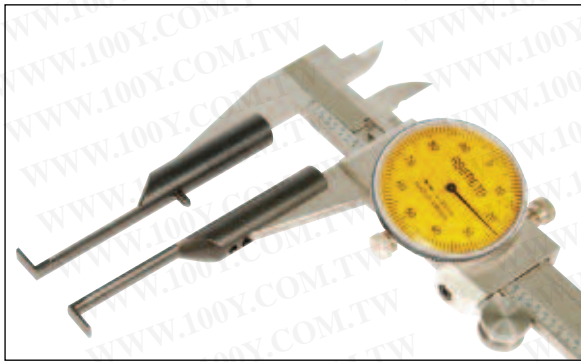
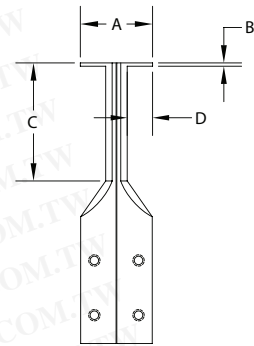

FEATURES

- Fits on any vernier, dial or digital 6" caliper
- Enables the measurement of hard to reach work piece characteristics such as internal grooves
- Measuring range of 0.200 to 6.000 inches
- Designed with an alignment pin ensuring correct alignment of the measuring surfaces
- Black Oxide finish

SPECIFICATIONS

Min Measurement (A)	Width of Feet (B)	Max Depth (C)	Groove Depth (D)	Code No.
.200"	.015"	.400"	.050"	300-21-0
.300"	.015"	.625"	.070"	300-22-0
.600"	.025"	1.000"	.200"	300-23-0
.725"	.040"	1.250"	.255"	300-24-0
External Measurement	.024"	3.000"	.375"	300-25-0
Set	Description			
3 Pair Set	Includes Max. Depth of .400, .625, & 1"			300-20-3
5 Pair Set	Includes All Jaws Pictured Above			300-20-5

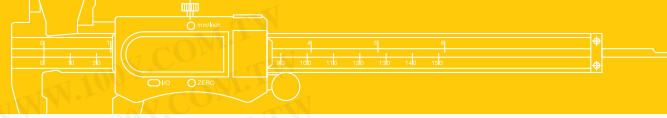

Tool Kits

960 Series

Kit #1 Analog

	Inch	Metric
Code No.	960-01-1	960-01-0
Individual Description	Individual Code No.	Individual Code No.
0-6" x .001", 0-150mm x 0.02mm Dial Caliper	303-06-1	303-06-2
0-1" x .0001", 0-25mm x 0.01mm Outside Mic.	101-01-3	101-01-0

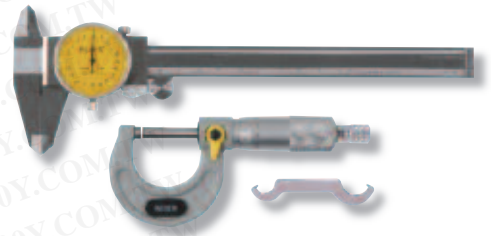

960-01-0

Kit #2 Analog Plus

	Inch	Metric
Code No.	960-02-1	960-02-0
Individual Description	Individual Code No.	Individual Code No.
0-6" x .001", 0-150mm x 0.02mm Dial Caliper	303-06-1	303-06-2
0-1" x .0001", 0-25mm x 0.01mm Outside Mic.	101-01-3	101-01-0
0-6" x .001", 0-150mm x 0.01mm Depth Mic.	201-06-1	201-06-0

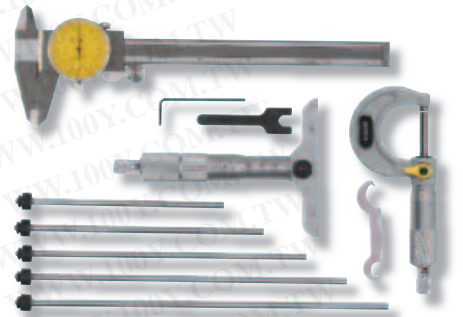

960-02-0

Kit #3 Digital Plus

	Inch	Metric
Code No.	960-03-1	960-03-0
Individual Description	Individual Code No.	Individual Code No.
0-6" x .0005", 0-150mm x 0.01mm Digital Caliper	307-06-5	307-06-5
0-1" x .00005", 0-25mm x 0.001mm Digital Outside Mic.	105-01-5	105-01-4
0-8" x .0005", 0-200mm x 0.01mm Digital Depth Caliper	327-08-7	327-08-7

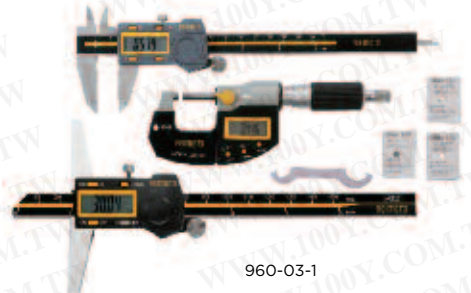

960-03-1

Kit #5 Digital

	Inch	Metric
Code No.	960-05-1	960-05-0
Individual Description	Individual Code No.	Individual Code No.
0-6" x .0005", 0-150mm x 0.01mm Digital Caliper	307-06-5	307-06-5
0-1" x .00005", 0-25mm x 0.001mm Digital Outside Mic.	105-01-5	105-01-4

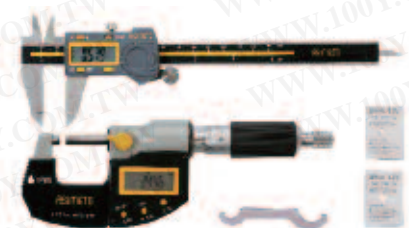

960-05-1

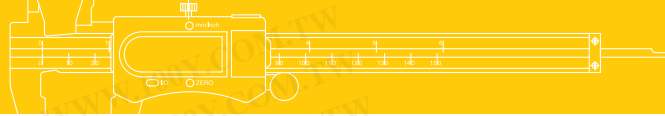

Tool Kits

960 Series



960-10-0

Kit #6 Magnetic Base and Dial Gauge

	Inch	Metric
Code No.	960-06-1	960-06-0
Individual Description	Individual Code No.	Individual Code No.
Magnetic Stand with 6" Rods and Universal Clamp	601-01-1	601-01-0
AGD2 Dial Indicator 0-1" x .001", 0-10mm x 0.01mm	402-26-1	402-10-0



960-08-0

Kit #7 Magnetic Base and Dial Gauge Plus

	Inch	Metric
Code No.	960-07-1	960-07-0
Individual Description	Individual Code No.	Individual Code No.
Magnetic Stand with 6" Rods and Universal Clamp	601-01-1	601-01-0
AGD2 Dial Indicator 0-.050" x .0001", 0-1mm x 0.001mm	402-01-1	402-01-0

Kit #8 Magnetic Adj. Base and Dial Gauge

	Inch	Metric
Code No.	960-08-1	960-08-0
Individual Description	Individual Code No.	Individual Code No.
Magnetic Stand with 6" Rods and Universal Clamp / Fine Adjustment	601-02-1	601-02-0
AGD2 Dial Indicator 0-1" x .001", 0-10mm x 0.01mm	402-26-1	402-10-0

Kit #9 Magnetic Adj. Base and Dial Gauge Plus

	Inch	Metric
Code No.	960-09-1	960-09-0
Individual Description	Individual Code No.	Individual Code No.
Magnetic Stand with 6" Rods and Universal Clamp / Fine Adjustment	601-02-1	601-02-0
AGD2 Dial Indicator 0-.050" x .0001", 0-1mm x 0.001mm	402-01-1	402-01-0

Kit #10 Magnetic Base and Test Indicator

	Inch	Metric
Code No.	960-10-1	960-10-0
Individual Description	Individual Code No.	Individual Code No.
Magnetic Stand with 6" Rods and Universal Clamp	601-01-1	601-01-0
Horiz. Dial Test Indicator .03" x .0005", 0.8mm x 0.01mm	501-73-3	501-08-2

Kit #11 Magnetic Base and Test Indicator Plus

	Inch	Metric
Code No.	960-11-1	960-11-0
Individual Description	Individual Code No.	Individual Code No.
Magnetic Stand with 6" Rods and Universal Clamp	601-01-1	601-01-0
Horiz. Dial Test Indicator .008" x .0001", 0.2mm x 0.002mm	501-78-3	501-02-2

Kit #12 Magnetic Adj. Base and Test Indicator

	Inch	Metric
Code No.	960-12-1	960-12-0
Individual Description	Individual Code No.	Individual Code No.
Magnetic Stand with 6" Rods and Universal Clamp / Fine Adjustment	601-02-1	601-02-0
Horiz. Dial Test Indicator .03" x .0005", 0.8mm x 0.01mm	501-73-3	501-08-2

Kit #13 Magnetic Adj. Base and Test Indicator Plus

	Inch	Metric
Code No.	960-13-1	960-13-0
Individual Description	Individual Code No.	Individual Code No.
Magnetic Stand with 6" Rods and Universal Clamp / Fine Adjustment	601-02-1	601-02-0
Horiz. Dial Test Indicator .008" x .0001", 0.2mm x 0.002mm	501-78-3	501-02-2

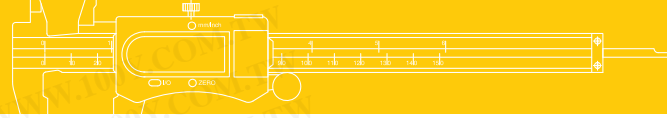

Tool Kits

960 Series

Kit #14B Digital Plus

	Inch	Metric
Code No.	960-14-1B	960-14-0B
Individual Description	Individual Code No.	Individual Code No.
ARTICULATING ARM WITH MAGNETIC BASE, TYPE II	602-02-1	602-02-1
0-.03" x .0005", 0-0.8mm x 0.01mm Horiz. Dial Test Indicator.	501-73-3	501-08-2
0-1" x .001", 0-25mm x 0.01mm Outside Mic.	101-01-1	101-01-0
0-1" x .00005", 0-25mm x 0.001mm Digital Outside Mic.	105-01-5	105-01-4
0-.5" x .0005", 0-10mm x 0.01mm AGD2 Dial Indicator	402-12-1	402-10-0
0-.5" x .0005", 0-12.5mm x 0.01mm Digital Indicators	407-01-3	407-01-2
0-6" x .0005", 0-150mm x 0.01mm ABS Digital Caliper	307-56-3	307-56-3
0-6" x .0005", 0-150mm x 0.01mm Dial Caliper	304-06-5	304-06-4



960-14-1B



960-14-XX

Kit #14W Digital Plus

	Inch	Metric
Code No.	960-14-1W	960-14-0W
Individual Description	Individual Code No.	Individual Code No.
ARTICULATING ARM WITH MAGNETIC BASE, TYPE II	602-02-1	602-02-1
0-.03" x .0005", 0-0.8mm x 0.01mm Horiz. Dial Test Indicator.	501-73-3	501-08-2
0-1" x .001", 0-25mm x 0.01mm Outside Mic.	101-01-1	101-01-0
0-1" x .00005", 0-25mm x 0.001mm Digital Outside Mic.	105-01-5	105-01-4
0-.5" x .0005", 0-10mm x 0.01mm AGD2 Dial Indicator	402-12-1	402-10-0
0-.5" x .0005", 0-12.5mm x 0.01mm Digital Indicators	407-01-3	407-01-2
0-6" x .0005", 0-150mm x 0.01mm ABS Digital Caliper	307-56-3	307-56-3
0-6" x .0005", 0-150mm x 0.01mm Dial Caliper	304-06-5	304-06-4



960-14-1W

Kit #16 Digital Plus

	Inch
Code No.	960-16-1
Individual Description	Individual Code No.
ARTICULATING ARM WITH MAGNETIC BASE, TYPE II	602-02-1
0-.03" x .0005" Horiz. Dial Test Indicator.	501-73-3
0-1" x .0001" Outside Mic.	101-01-3
0-1" x .001" AGD2 Dial Indicator	402-26-1
0-6" x .0005" IP67 Digital Calipers	301-06-0



960-16-1

Depth & Height Gauges

- 85 Depth Calipers
- 86 Depth Calipers With Single Hook
- 87 Depth Calipers With Double Hook
- 88 Depth Base Attachment for Calipers
- 88 Thickness Gauges
- 89 Depth Gauges
- 89 Digital Depth Gauges
- 90 Single Beam Digital Height Gauges with Hand Wheel
- 90 Digital Height Gauges
- 91 Double Beam Digit Counter Height Gauges with Hand Wheel
- 91 Double Beam Digital Height Gauges with Hand Wheel
- 92 Vernier Height Gauges

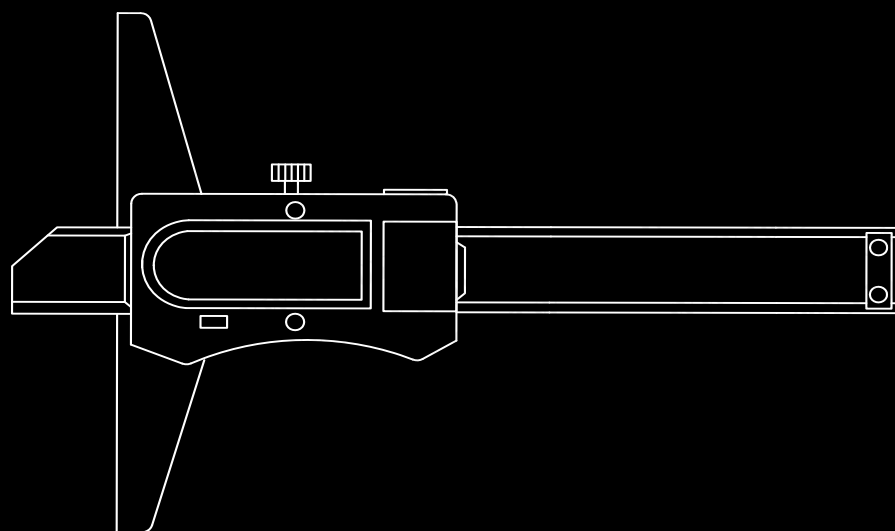



Depth Calipers

321 / 324 / 327 Series



327-06-7



324-12-1



321-08-2

FEATURES

- Resolution:
 - Digital models: .0005" / 0.01mm
 - Vernier models: .001" / 0.02mm or 0.05mm
 - Dial models: .001" / 0.02mm
- Both of the measuring surfaces are precision ground for accuracy
- Inch/Metric conversion
- Models are available in Absolute Digital, Vernier, Dial designs
- Cable data output: 900-05-4/5
- Wireless data output: 901-00-1

STANDARD ACCESSORIES

- Battery (Digital models)
- Warranty card, Instruction manual, Calibration certificate

SPECIFICATIONS

Inch			Metric			Inch		Metric	
Range	Graduation	Accuracy	Range	Graduation	Accuracy	Code No.	Code No.		
ABS Digital models									
0-6"	.0005"	±.001"	0-150mm	0.01mm	±0.02mm	-			327-06-7
0-8"	.0005"	±.0015"	0-200mm	0.01mm	±0.03mm	-			327-08-7
0-12"	.0005"	±.0015"	0-300mm	0.01mm	±0.04mm	-			327-12-7
Vernier models									
0-6"	.001"	±.001"	0-150mm	0.02mm	±0.02mm	321-06-1			321-06-2
0-8"	.001"	±.0015"	0-200mm	0.02mm	±0.03mm	321-08-1			321-08-2
0-12"	.001"	±.0015"	0-300mm	0.02mm	±0.04mm	321-12-1			321-12-2
0-20"	.001"	±.002"	0-500mm	0.02mm	±0.06mm	321-20-1			321-20-2
-	-	-	0-150mm	0.05mm	±0.05mm	-			321-06-0
-	-	-	0-200mm	0.05mm	±0.05mm	-			321-08-0
-	-	-	0-300mm	0.05mm	±0.05mm	-			321-12-0
Dial models									
0-6"	.001"	±.001"	0-150mm	0.02mm	±0.02mm	324-06-1			324-06-0
0-8"	.001"	±.0015"	0-200mm	0.02mm	±0.03mm	324-08-1			324-08-0
0-12"	.001"	±.0015"	0-300mm	0.02mm	±0.04mm	324-12-1			324-12-0

Dimension

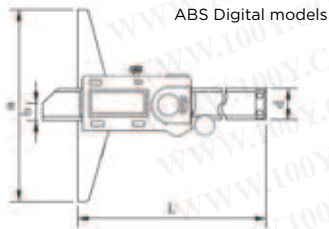

ABS Digital models

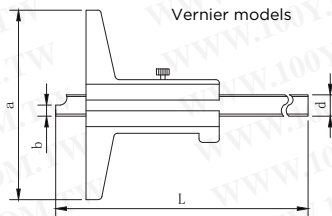

Vernier models

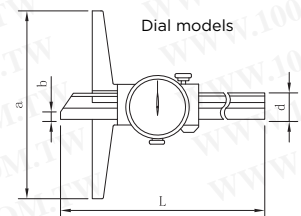

Dial models

Range	ABS Digital models / Digital models				Vernier models				Dial models				
	Inch/Metric	L	a	b	d	L	a	b	d	L	a	b	d
0-6"/0-150mm		230mm	100mm	6mm	14.5mm	250mm	100mm	5mm	10mm	236mm	100mm	4.6mm	13.5mm
0-8"/0-200mm		280mm	100mm	6mm	14.5mm	300mm	100mm	5mm	10mm	286mm	100mm	4.6mm	13.5mm
0-12"/0-300mm		380mm	100mm	6mm	14.5mm	400mm	100mm	5mm	10mm	386mm	100mm	4.6mm	13.5mm



Depth Calipers With Single Hook

322 Series



322-06-7



322-08-2

FEATURES

- Resolution:
Digital models: .0005" / 0.01mm
Vernier models: .001" / 0.05mm
- The stationary measuring surface on the beam protrudes at right angles (measuring hook) to allow for the measurement of depths, internal groove positions, and other intricate characteristics
- Measurements can be taken on either side of the measuring hook
- Vernier models are designed allowing the main beam to be reversible with corresponding scales on the slider
- All measuring surfaces are hardened
- Both Vernier and Digital models are available
- Cable data output: 900-05-4/5
- Wireless data output: 901-00-1

STANDARD ACCESSORIES

- Battery (Digital models)
- Warranty card, Instruction manual, Calibration certificate

SPECIFICATIONS

Inch			Metric			Inch		Metric	
Range	Resolution	Accuracy	Range	Resolution	Accuracy	Code No.	Code No.		
ABS Digital models									
0-6"	.0005"	±.001"	0-150mm	0.01mm	±0.02mm	-			322-06-7
0-8"	.0005"	±.0015"	0-200mm	0.01mm	±0.03mm	-			322-08-7
0-12"	.0005"	±.0015"	0-300mm	0.01mm	±0.04mm	-			322-12-7
Vernier models									
0-6"	.001"	±.001"	0-150mm	0.05mm	±0.05mm	322-06-3			322-06-2
0-8"	.001"	±.0015"	0-200mm	0.05mm	±0.05mm	322-08-3			322-08-2
0-12"	.001"	±.0015"	0-300mm	0.05mm	±0.08mm	322-12-3			322-12-2

Dimension

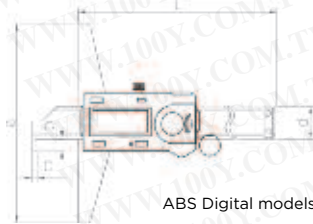

ABS Digital models

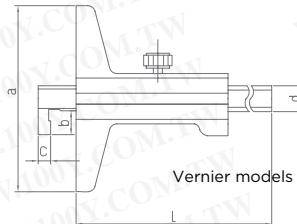

Vernier models

Range	ABS Digital models					Vernier models					
	Inch/Metric	L	a	b	c	d	L	a	b	c	d
0-6"/0-150mm		230mm	100mm	5mm	2mm	14.5mm	250mm	100mm	10mm	5mm	10mm
0-8"/0-200mm		280mm	100mm	5mm	2mm	14.5mm	300mm	100mm	10mm	5mm	10mm
0-12"/0-300mm		380mm	100mm	5mm	2mm	14.5mm	400mm	100mm	10mm	5mm	10mm



Depth Calipers With Double Hook

323 / 331 Series



323-06-7



331-08-2

FEATURES

- Resolution:
 - Digital models: .0005" / 0.01mm
 - Vernier models: .001" / 0.05mm
- The hooked measuring surfaces are used for measurement of internal or external grooves and other intricate work piece characteristics
- The main beam on the Vernier models is double sided with dual scales, and is able to be reversed in the slider for measurement flexibility
- The base and measuring faces are hardened and precision ground
- Both Digital and Vernier models are available
- Cable data output: 900-05-4/5
- Wireless data output: 901-00-1

STANDARD ACCESSORIES

- Battery (Digital models)
- Warranty card, Instruction manual, Calibration certificate

SPECIFICATIONS

Inch			Metric			Inch		Metric	
Range	Resolution	Accuracy	Range	Resolution	Accuracy	Code No.	Code No.		
ABS Digital models									
0-6"	.0005"	±.001"	0-150mm	0.01mm	±0.02mm	-	323-06-7		
0-8"	.0005"	±.0015"	0-200mm	0.01mm	±0.03mm	-	323-08-7		
0-12"	.0005"	±.0015"	0-300mm	0.01mm	±0.04mm	-	323-12-7		
Vernier models									
0-6"	.001"	±.001"	0-150mm	0.05mm	±0.05mm	331-06-3	331-06-2		
0-8"	.001"	±.0015"	0-200mm	0.05mm	±0.05mm	331-08-3	331-08-2		
0-12"	.001"	±.0015"	0-300mm	0.05mm	±0.08mm	331-12-3	331-12-2		

Dimension

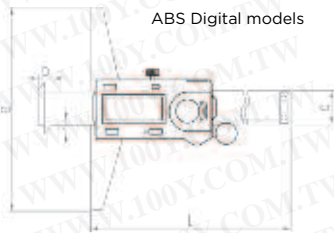

ABS Digital models

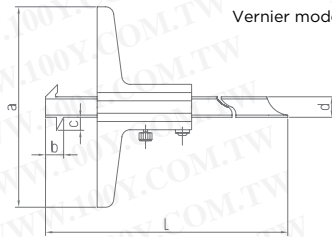

Vernier models

Range	ABS Digital models					Vernier models					
	Inch/Metric	L	a	b	c	d	L	a	b	c	d
0-6"/0-150mm		230mm	100mm	5mm	2mm	14.5mm	250mm	100mm	5mm	7mm	10mm
0-8"/0-200mm		280mm	100mm	5mm	2mm	14.5mm	300mm	100mm	5mm	7mm	10mm
0-12"/0-300mm		380mm	100mm	5mm	2mm	14.5mm	400mm	100mm	5mm	7mm	10mm

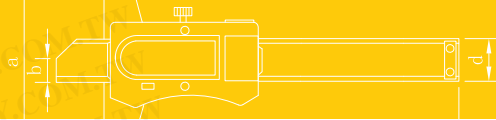

Depth Base Attachment for Calipers

327 Series

FEATURES

- For up to 200mm calipers with depth bar
- Made of stainless steel

SPECIFICATIONS

Base Length	Code No.
75mm/3"	327-66-9

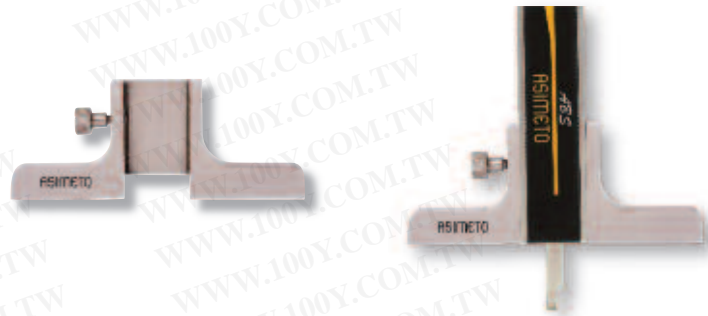

Thickness Gauges

495 / 491 Series



491-01-0



495-02-0

FEATURES

- Resolution:
Digital models: .0005" or .0001" / 0.01mm or 0.001mm
Dial models: .001" / 0.01mm
- Designed for the measurement of paper, film, wire, sheet metal, jewelry, leather and similar materials
- Measurement anvils are flat

STANDARD ACCESSORIES

- Battery (Digital models)
- Warranty card, Instruction manual, Calibration certificate

SPECIFICATIONS

Inch			Metric			Deep Throat	Code No.
Range	Resolution	Accuracy	Range	Resolution	Accuracy		
Digital models							
0-0.4"	.0005"	±.001"	0-10mm	0.01mm	±0.015mm	30mm	495-01-0
0-0.4"	.0005"	±.001"	0-10mm	0.01mm	±0.015mm	120mm	495-02-0
0-0.4"	.00005"	±.0005"	0-10mm	0.001mm	±0.01mm	30mm	495-01-3
0-0.4"	.00005"	±.0005"	0-10mm	0.001mm	±0.01mm	120mm	495-02-3
Dial models							
Range	Resolution	Accuracy	Range	Resolution	Accuracy	Code No.	Code No.
0-0.4"	.001"	±.001"	0-10mm	0.01mm	±0.015mm	491-01-1	491-01-0
0-0.4"	.001"	±.001"	0-10mm	0.01mm	±0.015mm	491-02-1	491-02-0



Depth Gauges

473 / 475 Series

FEATURES

- Resolution:
 - Digital models: .0005" or .0001" / 0.01mm or 0.001mm
 - Dial models: .001" / 0.01mm
- The total measuring range is accomplished with threaded depth rods in 1" or 20mm intervals
- The base surface is precisely finished and hardened for accurate repeatable measurements
- Inch/Metric conversion for digital models

STANDARD ACCESSORIES

- Battery (Digital models), Interchangeable rods
- Warranty card, Instruction manual, Calibration certificate

SPECIFICATIONS

Digital models

Inch			Metric			Stroke	Rods	Base Length	Code No.
Range	Resolution	Accuracy	Range	Resolution	Accuracy				
0-4"	.0005"	±.001"	0-100mm	0.01mm	0.02mm	12.7mm	10 pcs	63 x 17mm	475-04-0
0-4"	.0005"	±.001"	0-100mm	0.01mm	0.02mm	12.7mm	10 pcs	101.5 x 17mm	475-04-2
0-4"	.00005"	±.0005"	0-100mm	0.001mm	0.01mm	12.7mm	10 pcs	63 x 17mm	475-04-4
0-4"	.00005"	±.0005"	0-100mm	0.001mm	0.01mm	12.7mm	10 pcs	101.5 x 17mm	475-04-6

Dial models

Range	Resolution	Accuracy	Stroke	Rods	Base Length	Code No.
Inch						
0-4"	.001"	±.002"	1"	4 pcs	2.5" x .63"	473-04-1
0-4"	.001"	±.002"	1"	4 pcs	4" x .63"	473-04-3
Metric						
0-100mm	0.01mm	±0.02mm	10mm	10 pcs	63.5 x 17mm	473-04-0
0-100mm	0.01mm	±0.02mm	10mm	10 pcs	101.6 x 17mm	473-04-2



475-04-4



473-04-0

Digital Depth Gauges

321 Series

FEATURES

- Resolution: .0005" / 0.01mm
- The origin point is retained throughout the life of the battery
- Inch/Metric conversion
- Spherical end anvil

STANDARD ACCESSORIES

- Battery
- Warranty card, Calibration certificate

SPECIFICATIONS

Inch		Metric		Base Length	Code No.
Range	Accuracy	Range	Accuracy		
0-1.2"	±.0015"	0-30mm	±0.03mm	60mm	321-01-0



321-01-0

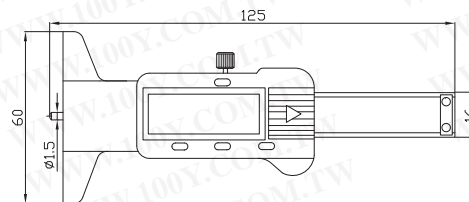



Single Beam Digital Height Gauges with Hand Wheel

626 Series

FEATURES

- Resolution: .0005" / 0.01mm
- Large LCD display
- Hand wheel design for fine adjustment
- Metric/Inch conversion at any position
- Zero setting on any position
- Carbide tipped scriber provided
- Manual power On/Off

STANDARD ACCESSORIES

- Carbide tipped scriber with clamp, Battery
- Warranty card, Instruction manual, Calibration certificate

SPECIFICATIONS

Inch		Metric		Code No.
Range	Accuracy	Range	Accuracy	
0-12"	±.0015"	0-300mm	±0.04mm	626-12-0
0-18"	±.0015"	0-450mm	±0.04mm	626-18-0
0-24"	±.0020"	0-600mm	±0.05mm	626-24-0
0-12"	±.0015"	0-300mm	±0.04mm	626-12-2
0-24"	±.0020"	0-600mm	±0.05mm	626-24-2



626-12-0

Dimension

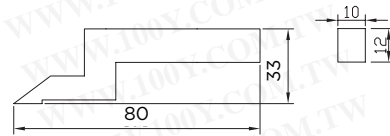

Digital Height Gauges

625 Series

FEATURES

- Resolution: .0005" / 0.01mm
- Origin memory eliminates the need to zero the reading each time the height gauge is turned on
- Can be used with a test indicator and holder for precise measurement
- Inch/Metric conversion
- The fine-adjustment allows the slider to be precisely positioned
- The base is designed with a thermal heat isolation hand grip

STANDARD ACCESSORIES

- Carbide tipped scriber with clamp, Battery
- Warranty card, Instruction manual, Calibration certificate

SPECIFICATIONS

Inch		Metric		Code No.
Range	Accuracy	Range	Accuracy	
0-12"	±.0015"	0-300mm	±0.04mm	625-12-0
0-24"	±.0020"	0-600mm	±0.07mm	625-24-0
0-40"	±.0040"	0-1000mm	±0.10mm	625-40-0



625-24-0

Dimension

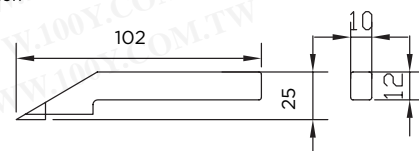



Double Beam Digit Counter Height Gauges with Hand Wheel

623 Series



623-18-1

FEATURES

- Graduation: .001" / 0.01mm.
- Position is displayed by a combination of the digit counter and the dial
- Hand wheel design for both coarse and fine adjustments
- Digit counter graduation: Inch .1" / Metric 1mm
- The digit counters provide bi-directional positioning and the capability of setting zero at any position

STANDARD ACCESSORIES

- Carbide tipped scriber with clamp
- Warranty card, Instruction manual, Calibration certificate

SPECIFICATIONS

Inch		Metric		Inch	Metric
Range	Accuracy	Range	Accuracy	Code No.	Code No.
0-12"	±0.015"	0-300mm	±0.04mm	623-12-1	623-12-0
0-18"	±0.020"	0-450mm	±0.05mm	623-18-1	623-18-0
0-24"	±0.020"	0-600mm	±0.07mm	623-24-1	623-24-0
0-40"	±0.030"	0-1000mm	±0.07mm	623-40-1	623-40-0

Dimension

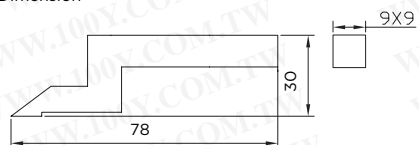

Double Beam Digital Height Gauges with Hand Wheel

627 Series



627-24-0

FEATURES

- Resolution: .001" / 0.01mm
- Designed with hand wheel micro-adjustable rack and pinion for precision positioning
- Can be used with a test indicator and holder for precise measurement
- High precision, measurement more accurate
- Zero setting at any position
- Manual power On/Off
- Metric/Inch system conversion
- Large LCD display

STANDARD ACCESSORIES

- Carbide tipped scriber with clamp, Battery
- Warranty card, Instruction manual, Calibration certificate

SPECIFICATIONS

Inch		Metric		
Range	Accuracy	Range	Accuracy	Code No.
0-12"	±.001"	0-300mm	±0.02mm	627-12-0
0-18"	±.0015"	0-450mm	±0.03mm	627-18-0
0-24"	±.0015"	0-600mm	±0.03mm	627-24-0

Dimension

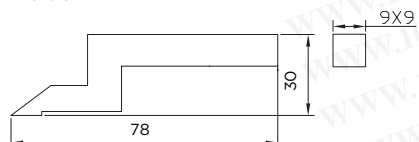



Vernier Height Gauges

621 Series

FEATURES

- Graduation:
Inch: .001" or 1/128"
Metric: 0.02mm or 0.05mm
- The fine-adjustment allows the slider to be precisely positioned
- Matte chrome finish
- Stainless steel design
- The base is designed with a thermal heat isolation hand grip

STANDARD ACCESSORIES

- Carbide tipped scriber with clamp
- Warranty card, Instruction manual, Calibration certificate

SPECIFICATIONS

Inch			Metric			Code No.
Range	Graduation	Accuracy	Range	Graduation	Accuracy	
0-12"	1/128"	±.0015"	0-300mm	0.05mm	±0.05mm	621-12-0
0-18"	1/128"	±.0015"	0-450mm	0.05mm	±0.08mm	621-18-0
0-20"	1/128"	±.0015"	0-500mm	0.05mm	±0.08mm	621-20-0
0-24"	1/128"	±.0020"	0-600mm	0.05mm	±0.10mm	621-24-0
0-40"	1/128"	±.0020"	0-1000mm	0.05mm	±0.10mm	621-40-0
0-12"	.001"	±.0015"	0-300mm	0.02mm	±0.04mm	621-12-2
0-18"	.001"	±.0015"	0-450mm	0.02mm	±0.05mm	621-18-2
0-20"	.001"	±.0015"	0-500mm	0.02mm	±0.05mm	621-20-2
0-24"	.001"	±.0020"	0-600mm	0.02mm	±0.07mm	621-24-2
0-40"	.001"	±.0020"	0-1000mm	0.02mm	±0.07mm	621-40-2



621-24-0

Dimension

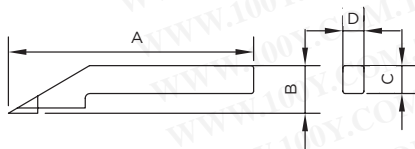

Range	A	B	C	D
0-12"/0-300mm	97mm	32mm	15mm	11mm
0-18"/0-450mm	97mm	32mm	15mm	11mm
0-20"/0-500mm	97mm	32mm	15mm	11mm
0-24"/0-600mm	97mm	32mm	15mm	11mm
0-40"/0-1000mm	80mm	94mm	14mm	11mm

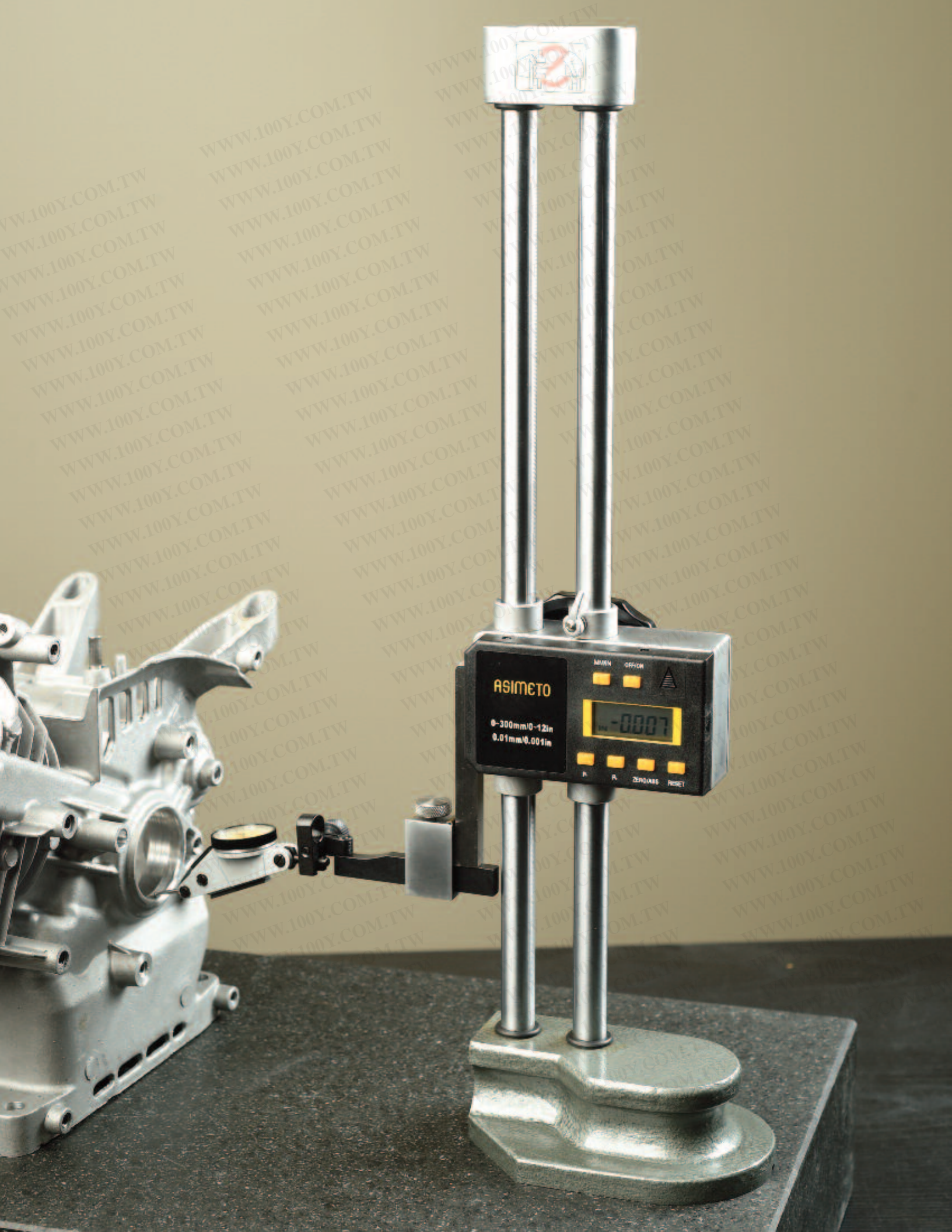

ASIMETO
0-300mm/0-12in
0.01mm/0.001in

MAIN OFFON
-0.007
P P ZERO/LAS RESET

Indicators & Dial Gauges

95	IP65 Digital Indicators	113	Centering Indicators
96	Digital Indicators	114	Zero Set Holder
97	AGD1 Dial Indicators	114	Zero Set Universal Attachment
98	AGD2 Dial Indicators	115	Axial Support Bracket
101	Crank Shaft Gauges	115	Double-Jointed Dovetail Holder
101	Dial Comparators	115	Surface Gauges
102	Dial Indicators - One revolution for Error-free Reading	116	Spring-Loaded Tension Clamps
102	Straight Metric Indicator Stem Bushing	116	Clamps with Dovetail
103	Back Plunger Type Dial Indicators	117	Inside/Outside Diameter Groove Gauges
103	Back Plunger Dial Indicator Sets	117	Dial Indicator Depth Bases
104	Ball Indicator Points	117	Dial Holders
104	Flat Carbide Needle Indicator Points	117	Universal Dovetail Indicator Holder
105	Dial Indicator Points	118	Optional Accessories for ASIMETO Test Indicators
105	Stem Indicator Points	119	Dial Gauge Stands
106	Ball Tip Dial Indicator Points	119	Precision Granite Stands
107	Dial Indicator Extension Rods & Sets	120	Magnetic Bases
107	Indicator Probe Holders	120	Forced Locking Magnetic Bases
108	Dial Test Indicators	121	Flexible Arm Magnetic Bases
110	Extended Range Dial Test Indicators	121	Articulating Arm Magnetic Bases
111	Extended Range Dial Test Indicator Sets	122	Hydraulic Magnetic Bases
112	Digital Test Indicator	122	Magnetic Bases
112	Digital Radius Gauge	122	Permanent Magnetic Base

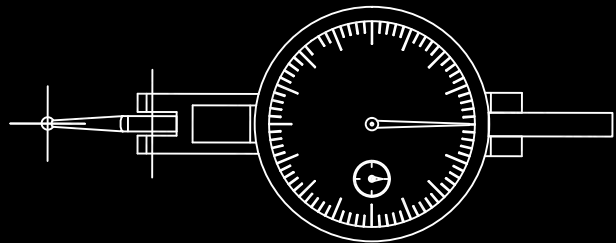
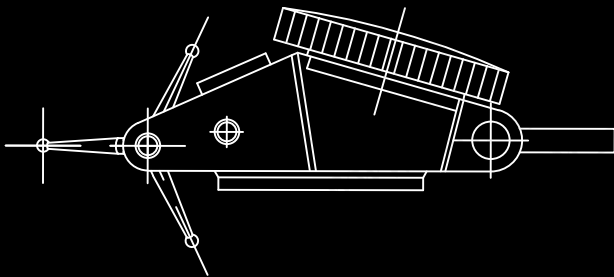



IP65 Digital Indicators

407 Series



407-02-5



407-01-4



Lifting lever

FEATURES

- Resolution:
 - Inch: .0005"; .00005"
 - Metric: 0.01mm; 0.001mm
- Absolute measurement
- Tolerance measurement feature allows for the upper and lower tolerance for maximum and minimum.
- Inch/Metric and ABS/INC conversion
- Flat back (attached) and lug back supplied
- Ø8mm stem diameter for metric models
- Ø3/8" stem diameter for inch models
- 360 deg. screen rotation
- Cable data output: 900-07-0/1
- Wireless data output: 901-00-2

STANDARD ACCESSORIES

- Lug Back, Battery, Lifting lever (More than 1 inch)
- Warranty card, Instruction manual, Calibration certificate

SPECIFICATIONS

Inch			Metric			Inch		Metric	
Range	Resolution	Accuracy	Range	Resolution	Accuracy	Code No.	Code No.		
0-.5"	.0005"	±.0008"	0-12.5mm	0.01mm	±0.02mm	407-01-3	407-01-2		
0-1"	.0005"	±.0012"	0-25mm	0.01mm	±0.02mm	407-02-3	407-02-2		
0-2"	.0005"	±.0012"	0-50mm	0.01mm	±0.02mm	407-03-3	407-03-2		
0-.5"	.00005"	±.00016"	0-12.5mm	0.001mm	±0.004mm	407-01-5	407-01-4		
0-1"	.00005"	±.0002"	0-25mm	0.001mm	±0.005mm	407-02-5	407-02-4		
0-2"	.00005"	±.00025"	0-50mm	0.001mm	±0.006mm	407-03-5	407-03-4		

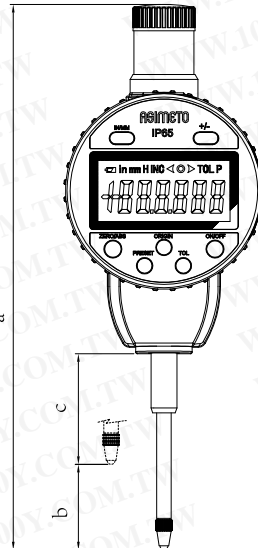
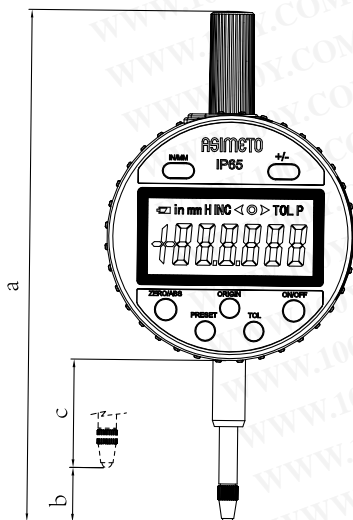

Range	A	B	C
	mm	mm	mm
0-0.5"/0-12.5mm	126.5	13.5	26.8
0-1"/0-25mm	169	26.5	34.3
0-2"/0-50mm	246	52	33.7



Digital Indicators

405 Series



405-95-1



405-01-0

FEATURES

- Resolution:
 - Inch: .0005"; .00005"
 - Metric: 0.01mm; 0.001mm
- The maximum, minimum, or runout value can be displayed during measurement.
- Tolerance measurement feature allows for the upper and lower tolerance for maximum and minimum.
- Inch/Metric and ABS/INC conversion
- Flat back (attached) and lug back supplied
- Ø8mm stem diameter for metric models
- Ø3/8" stem diameter for inch models

STANDARD ACCESSORIES

- Lug Back, Battery
- Warranty card, Instruction manual, Calibration certificate

SPECIFICATIONS

Inch			Metric			Inch		Metric	
Range	Resolution	Accuracy	Range	Resolution	Accuracy	Code No.	Code No.		
0-.5"	.0005"	±.0008"	0-12.5mm	0.01mm	±0.02mm	405-95-1	405-95-0		
0-1"	.0005"	±.0012"	0-25mm	0.01mm	±0.02mm	405-01-1	405-01-0		
0-2"	.0005"	±.0012"	0-50mm	0.01mm	±0.02mm	405-02-1	405-02-0		
0-4"	.0005"	±.0012"	0-100mm	0.01mm	±0.03mm	405-04-1	405-04-0		
0-.5"	.00005"	±.00016"	0-12.5mm	0.001mm	±0.004mm	405-95-5	405-95-4		
0-1"	.00005"	±.0002"	0-25mm	0.001mm	±0.005mm	405-01-5	405-01-4		
0-2"	.00005"	±.00025"	0-50mm	0.001mm	±0.006mm	405-02-5	405-02-4		
0-4"	.00005"	±.0003"	0-100mm	0.001mm	±0.008mm	405-04-5	405-04-4		

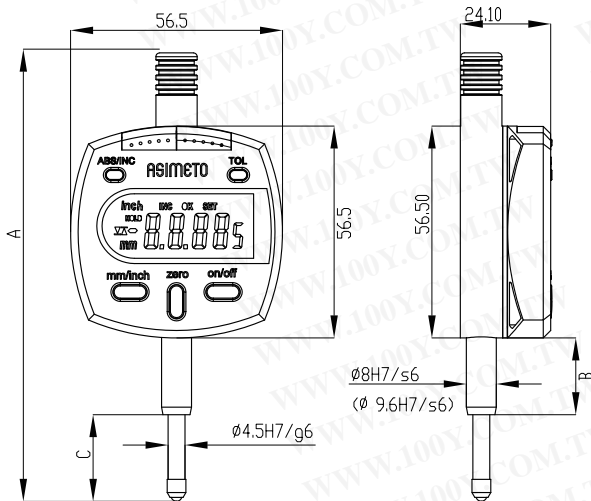

Range	A	B	C
	mm	mm	mm
0-.5"/0-12.5mm	122	26	24
0-1"/0-25mm	174	47	41
0-2"/0-50mm	248	71	61
0-4"/0-100mm	396	35	102



AGD1 Dial Indicators

401 Series

FEATURES

- Graduation:
Inch: .0005" / .001"
Metric: 0.01mm
- Dial face dia.: Ø1.61" / Ø42mm
- Jeweled
- Flat back (attached) and lug back supplied
- Inch models without revolution Counter

STANDARD ACCESSORIES

- Flat Back
- Warranty card, Instruction manual, Calibration certificate



401-06-1



401-05-2

SPECIFICATIONS

Range	Graduation	Range / Rev.	Dial reading	Accuracy	Code No.
Stem diameter Ø3/8"					
.25"	.001"	.1"	0-100	±.001"	401-06-1
.25"	.001"	.1"	0-50-0	±.001"	401-06-3
.25"	.0005"	.05"	0-25-0	±.0005"	401-06-5
3mm	0.01mm	0.5mm	0-50	±0.02mm	401-03-1
5mm	0.01mm	0.5mm	0-50	±0.02mm	401-05-1
5mm	0.01mm	0.5mm	0-25-0	±0.02mm	401-05-3
Stem diameter Ø8mm					
3mm	0.01mm	0.5mm	0-50	0.014mm	401-03-0
5mm	0.01mm	0.5mm	0-50	0.016mm	401-05-0
5mm	0.01mm	0.5mm	0-25-0	0.016mm	401-05-2

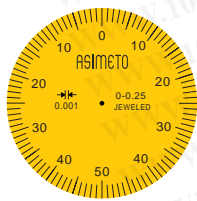

401-06-3

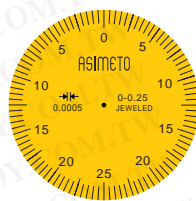

401-06-5

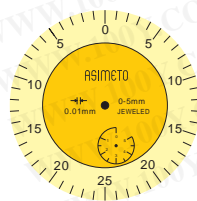

401-05-2

401-05-3

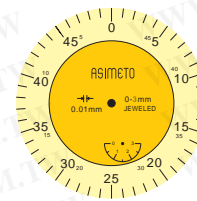

401-03-0

401-03-1

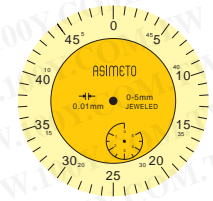

401-05-0

401-05-1

Inch Dimension

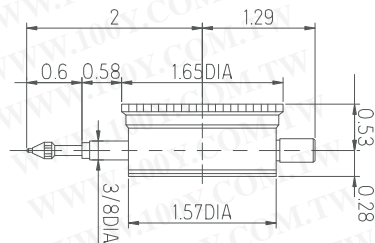

Metric Dimension

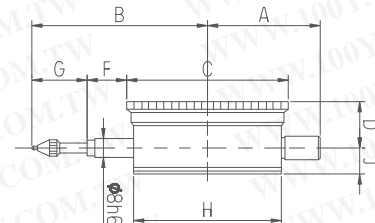

Range	A	B	C	D	F	G	H	J
	mm	mm	mm	mm	mm	mm	mm	mm
0-3mm	30.6	46.4	42	13.5	14.7	10.7	40	7
0-5mm	30.6	48.4	42	13.5	14.7	12.7	40	7



AGD2 Dial Indicators

402 Series

FEATURES

- Graduation Inch: .0001" / .0005" / .001"; Metric / 0.001mm / 0.01mm
- Dial face dia.: Ø2.20" / Ø58mm
- Easy to read dial face
- Jeweled
- Internal tolerance marker
- Flat back (attached) and lug back supplied
- With counter pointer
- IP54 water proof series: with sealed housing & water resistant ring.

STANDARD ACCESSORIES

- Flat back, Warranty card, Instruction manual, Calibration certificate

SPECIFICATIONS

Range	Graduation	Range / Rev.	Dial reading	Accuracy	Code No.
Stem Diameter Ø3/8"					
.05"	.0001"	.01"	0-100	±.0001"	402-01-1
.05"	.0001"	.01"	0-50-0	±.0001"	402-01-3
.25"	.001"	.1"	0-100	±.002"	402-06-1
.25"	.001"	.1"	0-50-0	±.002"	402-06-3
.25"	.0005"	.05"	0-25-0	±.0015"	402-06-5
.50"	.001"	.1"	0-100	±.002"	402-12-1
.50"	.001"	.1"	0-50-0	±.002"	402-12-3
.50"	.0005"	.05"	0-50	±.002"	402-12-5
1"	.001"	.1"	0-100	±.002"	402-26-1
1"	.001"	.1"	0-50-0	±.002"	402-26-3
1"	.0005"	.05"	0-50	±.002"	402-26-5
2"	.001"	.1"	0-100	±.004"	402-51-1
3mm	0.01mm	1mm	0-100	±0.03mm	402-03-1
3mm	0.01mm	1mm	0-50-0	±0.03mm	402-03-3
5mm	0.01mm	1mm	0-100	±0.03mm	402-05-1
5mm	0.01mm	1mm	0-50-0	±0.03mm	402-05-3
10mm	0.01mm	1mm	0-100	±0.03mm	402-10-1
10mm	0.01mm	1mm	0-50-0	±0.03mm	402-10-3
20mm	0.01mm	1mm	0-50-0	±0.04mm	402-20-1
25mm	0.01mm	1mm	0-50-0	±0.04mm	402-25-3
Stem Diameter Ø8mm					
1mm	0.001mm	0.2mm	0-200	±0.005mm	402-01-0
1mm	0.001mm	0.2mm	0-100-0	±0.005mm	402-01-2
3mm	0.01mm	1mm	0-100	±0.014mm	402-03-0
3mm	0.01mm	1mm	0-50-0	±0.014mm	402-03-2
5mm	0.01mm	1mm	0-100	±0.016mm	402-05-0
5mm	0.01mm	1mm	0-50-0	±0.016mm	402-05-2
10mm	0.01mm	1mm	0-100	±0.02mm	402-10-0
10mm	0.01mm	1mm	0-50-0	±0.02mm	402-10-2
20mm	0.01mm	1mm	0-50-0	±0.025mm	402-20-0
20mm	0.01mm	1mm	0-100	±0.025mm	402-20-2
25mm	0.01mm	1mm	0-50-0	±0.035mm	402-25-0
25mm	0.01mm	1mm	0-100	±0.035mm	402-25-2
30mm	0.01mm	1mm	0-100	±0.035mm	402-30-0
30mm	0.01mm	1mm	0-50-0	±0.035mm	402-30-2
50mm	0.01mm	1mm	0-100	±0.035mm	402-50-0
100mm	0.01mm	1mm	0-100	±0.050mm	402-00-0
Shock Proof. Stem Diameter Ø8mm					
5mm	0.01mm	1mm	0-100	±0.016mm	402-05-4
10mm	0.01mm	1mm	0-100	±0.02mm	402-10-8
20mm	0.01mm	1mm	0-100	±0.025mm	402-20-8
IP54 Water Proof Series					
10mm (Stem Dia. Ø8mm)	0.01mm	1mm	0-100	±0.02mm	402-10-4
0.4" (Stem Dia. Ø3/8")	.001"	.1"	0-100	±.002"	402-26-7
0.4" (Stem Dia. Ø3/8")	.0005"	.05"	0-50	±.0015"	402-26-9



402-10-0



402-26-5



402-10-4



AGD2 Dial Indicators

402 Series

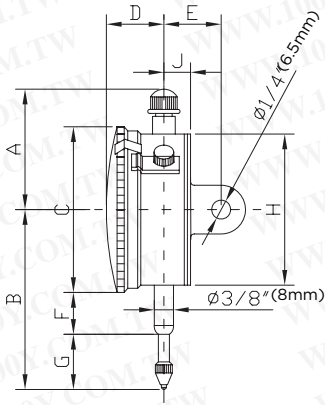

Range	A	B	C	D	E	F	G	H	J
Inch	inch	inch	inch	inch	inch	inch	inch	inch	inch
0-.05"	1.76	2.39	2.28	0.64	0.76	0.69	0.56	2.11	0.32
0-.25"	1.48	2.54	2.28	0.64	0.76	0.69	0.71	2.11	0.32
0-.5"	1.48	2.74	2.28	0.64	0.76	0.69	0.91	2.11	0.32
0-1"	1.48	3.21	2.28	0.64	0.76	0.69	1.38	2.11	0.32
0-2"	4.73	5.5	2.28	0.7	0.76	2	2.34	2.11	0.32
Metric	mm	mm	mm	mm	mm	mm	mm	mm	mm
0-1mm	45	62	58	16.2	19.3	18.3	15	53.5	8.1
0-3mm	43.7	68.5	58	16.3	19	18.3	15	53.5	8.1
0-5mm	43.7	68.5	58	16.3	19	18.3	15	53.5	8.1
0-10mm	43.7	68.5	58	16.3	19	18.3	15	53.5	8.1
0-20mm	37.5	80.5	58	16.3	19.4	17.5	34	53.5	8.4
0-25mm	37.5	80.5	58	16.3	19.4	17.5	34	53.5	8.4
0-30mm	43.7	88	58	15	20	21.5	37.5	53.5	9

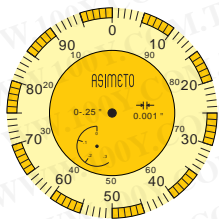

402-06-1

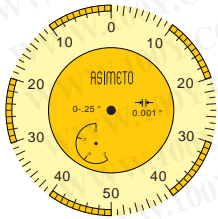

402-06-3

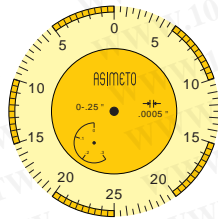

402-06-5

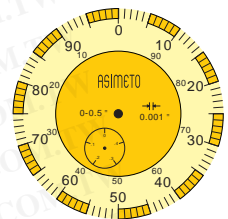

402-12-1

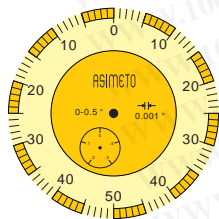

402-12-3

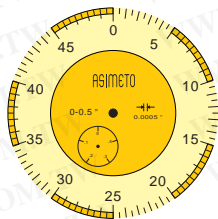

402-12-5

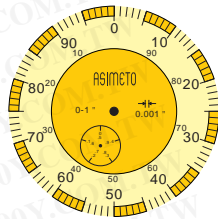

402-26-1

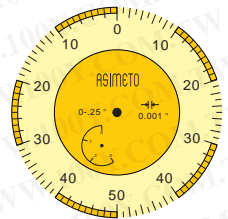

402-26-3

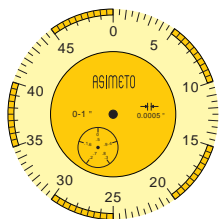

402-26-5

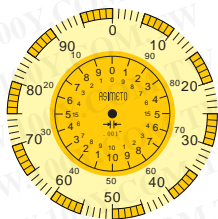

402-51-1

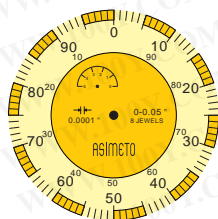

402-01-1

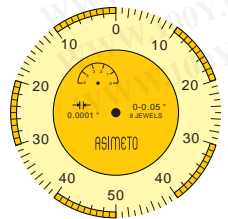

402-01-3



AGD2 Dial Indicators

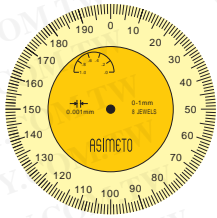

402-01-0

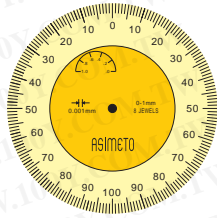

402-01-2

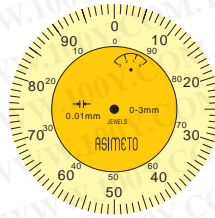

402-03-0
402-03-1

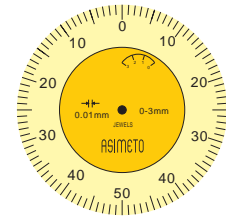

402-03-2
402-03-3

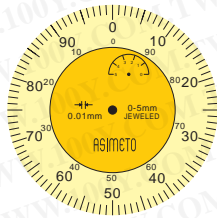

402-05-0
402-05-1

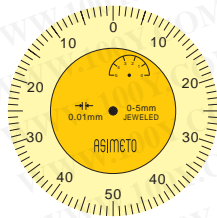

402-05-2
402-05-3

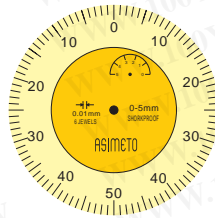

402-05-4

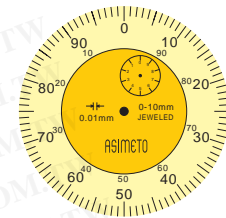

402-10-0
402-10-1

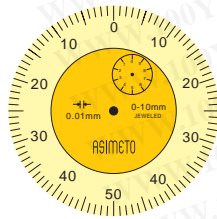

402-10-2
402-10-3



402-10-8

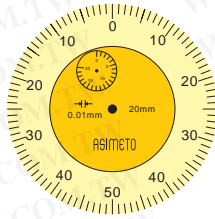

402-20-0
402-20-1

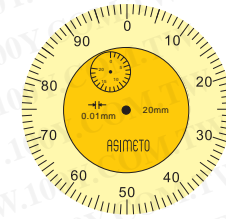

402-20-2

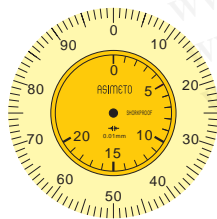

402-20-8



402-25-0
402-25-3

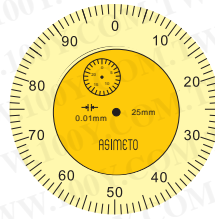

402-25-2

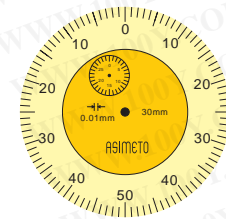

402-30-2

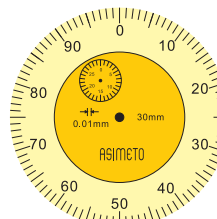

402-30-0



Crank Shaft Gauges

469 Series



FEATURES

- Graduation: 0.01mm
- For checking crank shafts and crank shaft bearings of motors for ships, cars, trucks etc. Also in departments for grinding crankshafts, repair of crankshafts and especially for checking of motors or compressors in situ.

STANDARD ACCESSORIES

- Rod, Anvil
- Warranty card, Calibration certificate

SPECIFICATIONS

Range	Dial Travel	Resolution	Code No.
60-300mm	0-3mm	0.01mm	469-10-3
60-500mm	0-3mm	0.01mm	469-10-5

Dial Comparators

422 Series



FEATURES

- Resolution: 0.001mm
- High accuracy
- Jeweled and shock proof
- Water and dust resistant design
- With 8mm stem diameter

STANDARD ACCESSORIES

- Spindle lifting cable
- Warranty card, Instruction manual, Calibration certificate

SPECIFICATIONS

Range	Resolution	Dial reading	Accuracy	Code No.
G Series				
±0.02"	.00005"	.002-0-.002	±0.00006"	422-21-1
±0.05mm	0.001mm	50-0-50	±0.0012mm	422-21-2

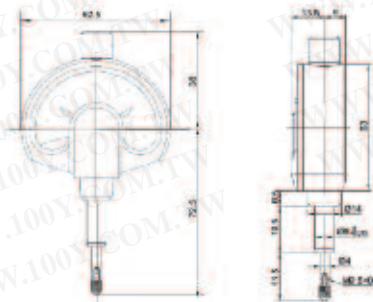



Dial Indicators - One revolution for Error-free Reading

422 Series



422-01-0

FEATURES

- Graduation: 0.01mm
- AGD2 series, dial face dia. $\varnothing 2.20'' / \varnothing 58\text{mm}$
- Easy to read dial face
- A pair of limit hands are provided for quick and easy tolerance judgment
- Provided with an improved resistance to shop floor contaminants such as water and dust
- With Flat back
- With $\varnothing 8\text{mm}$ stem diameter

STANDARD ACCESSORIES

- Warranty card, Calibration certificate

SPECIFICATIONS

Range	Graduation	Dial reading	Accuracy	Code No.
0.8mm	0.01mm	40-0-40	$\pm 0.009\text{mm}$	422-01-0
G Series				
0.16mm	0.001mm	90-0-90	$\pm 0.009\text{mm}$	422-02-1
0.4mm	0.005mm	20-0-20	$\pm 0.009\text{mm}$	422-03-1

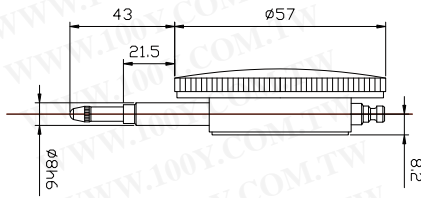

Straight Metric Indicator Stem Bushing

500 Series



FEATURES

- Accepts 8MM stem, converts to 3/8" diameter stem.
- Straight bushing, no head.
- .500" length.
- Brass, Nickel Plated.

SPECIFICATIONS

Code No.
500-32-0



Back Plunger Type Dial Indicators

422 Series

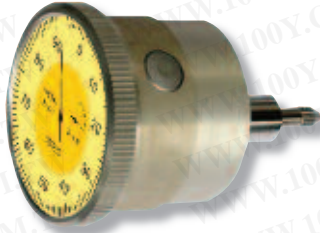

422-11-1

FEATURES

- Graduation: .001" / 0.01mm
- Easy to read dial face with dial revolution counter
- Back plunger type dial indicators are designed to be used in fixtures and other applications that the dial reading is best viewed from an axis parallel to that of the indicator measuring axis

STANDARD ACCESSORIES

- Warranty card, Calibration certificate

SPECIFICATIONS

Range	Graduation	Accuracy	Range / Rev.	Dial Dia.	Stem diameter	Dial reading	Code No.
Inch							
.1"	.001"	±.001"	.1"	1.6"	Ø3/8"	0-100	422-11-1
.2"	.001"	±.001"	.1"	1.6"	Ø3/8"	0-100	422-12-1
Metric							
1mm	0.01mm	±0.015mm	1mm	58mm	Ø8mm	0-100	422-11-2
3mm	0.01mm	±0.015mm	1mm	58mm	Ø8mm	0-100	422-12-2
5mm	0.01mm	±0.02mm	1mm	58mm	Ø8mm	0-100	422-13-2

Back Plunger Dial Indicator Sets

422 Series



FEATURES

- Ideal for fast, accurate set-ups and measurements on lathes, milling machines, planers, shapers, etc. plus various inspection applications.
- Each set includes:
 - Test Indicator, fully jeweled
 - Universal clamp
 - Toolpost holder
 - 5/16" x 3" holding rod
 - 5/16" x 5" holding rod
 - #4-48 thread size
 - "G" clamp
- Lever attachment.
- Spherical, tapered and standard anvils are supplied.

SPECIFICATIONS

Range	Graduation	Accuracy	Reading	Code No.
0- .1"	.001"	±.001"	0-50-0	422-15-1
0- .1"	.001"	±.001"	0-100	422-15-3
0-2mm	0.01mm	±0.015mm	0-50-0	422-15-0
0-2mm	0.01mm	±0.015mm	0-100	422-15-2
Sets				
0- .1"	.001"	±.001"	0-50-0	422-15-7
0- .1"	.001"	±.001"	0-100	422-15-9
0-2mm	0.01mm	±0.015mm	0-50-0	422-15-6
0-2mm	0.01mm	±0.015mm	0-100	422-15-8



Ball Indicator Points

477 Series

FEATURES

- Precision contact points for use on standard travel dial indicators
- Both tungsten carbide and ruby have extremely hard and smooth measuring surfaces
- Fit all AGD Group 1, 2, 3 and 4 indicators



SPECIFICATIONS

Ball Diameter (mm)	Length	Body Diameter (in)	Ball Material	Code No. (4-48 Threads)	Code No. (M2.5 Threads)
2	1/4"	.187	Carbide	477-00-1	477-00-0
2	1/2"	.187	Carbide	477-01-1	477-01-0
2	3/4"	.187	Carbide	477-02-1	477-02-0
2	1	.187	Carbide	477-03-1	477-03-0
3	1/4"	.187	Carbide	477-04-1	477-04-0
3	1/2"	.187	Carbide	477-05-1	477-05-0
3	3/4"	.187	Carbide	477-06-1	477-06-0
3	1	.187	Carbide	477-07-1	477-07-0
4	1/4"	.187	Carbide	477-08-1	477-08-0
4	1/2"	.187	Carbide	477-09-1	477-09-0
4	3/4"	.187	Carbide	477-10-1	477-10-0
4	1	.187	Carbide	477-11-1	477-11-0
2	1/4"	.187	Ruby	477-12-1	477-12-0
2	1/2"	.187	Ruby	477-13-1	477-13-0
2	3/4"	.187	Ruby	477-14-1	477-14-0
2	1	.187	Ruby	477-15-1	477-15-0
3	1/4"	.187	Ruby	477-16-1	477-16-0
3	1/2"	.187	Ruby	477-17-1	477-17-0
3	3/4"	.187	Ruby	477-18-1	477-18-0
3	1	.187	Ruby	477-19-1	477-19-0
4	1/4"	.187	Ruby	477-20-1	477-20-0
4	1/2"	.187	Ruby	477-21-1	477-21-0
4	3/4"	.187	Ruby	477-22-1	477-22-0
4	1	.187	Ruby	477-23-1	477-23-0

477 Series

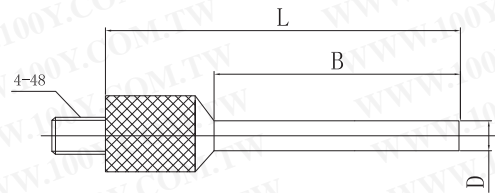

SPECIFICATIONS

D	B	L	Code No.
.015	.120	.400	477-01-5
.031	.120	.400	477-02-5
.031	.500	.780	477-03-5
.062	.500	.800	477-04-5
.062	1.00	1.300	477-05-5
.078	1.00	1.300	477-06-5



Dial Indicator Points

477 Series

FEATURES

- Each point is carefully manufactured of Stainless steel.
- 4 - 48 Threads for use in AGD 1, 2, 3, 4 indicators.

SPECIFICATIONS

Type	Body Diameter (in)	Length (in)	Code No.
Flat	7/32	1/8	477-01-3
Flat	7/32	1	477-02-3
Flat	5/16	.175	477-03-3
Flat	7/32	.175	477-04-3
Flat	7/32	1/4	477-05-3
Flat	7/32	3/8	477-06-3
Flat	7/32	1/2	477-07-3
Flat	7/32	5/8	477-08-3
Flat	7/32	3/4	477-09-3
Flat	7/32	7/8	477-10-3
Flat	7/32	.895	477-11-3
Flat	7/32	1-1/4	477-12-3
Flat	7/32	1-1/2	477-13-3
Ball	7/32	7/32	477-14-3
Ball	7/32	13/32	477-15-3
Ball	7/32	5/8	477-16-3
Ball	7/32	13/16	477-17-3
Ball	7/32	7/8	477-18-3
Ball	3/16	1	477-19-3
Cone	7/32	1/2	477-20-3
Cone	7/32	5/8	477-21-3
Cone	7/32	3/4	477-22-3
Cone	7/32	7/8	477-23-3
Cone	7/32	1	477-24-3



Flat



Ball



Cone

Stem Indicator Points

477 Series



Bent Stem



Double Stem



Single Stem

FEATURES

- Each point is carefully manufactured of Stainless steel.
- 4 - 48 Threads for use in AGD 1, 2, 3, 4 indicators.

SPECIFICATIONS

Type	D	A	E	L	C	B	Code No.
Bent Stem	7/32	5/16	1/16	7/16	N/A	N/A	477-01-7
Double Stem	7/32	5/16	1/64	.697	.118	.24	477-02-7
Double Stem	7/32	1/4	0.023	.960	.1	.585	477-03-7
Double Stem	7/32	1/4	0.023	.960	.235	.47	477-04-7
Single Stem	3/16	3/16	1-5/32	1-5/32	N/A	N/A	477-05-7

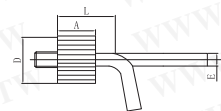

Bent Stem

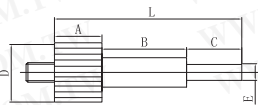

Double Stem

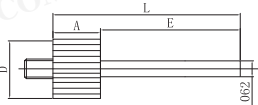

Single Stem



Ball Tip Dial Indicator Points

477 Series



FEATURES

- Grade 25 chrome alloy steel balls.
- Use only as an indicator point and not for sizing or gauging applications where side pressure would be present.

SPECIFICATIONS

Ball Diameter	Stem Length	Major Stem Diameter	Minor Stem Diameter	Thread	Code No.
.0310"	.600"	.156"	.025"	4-48	477-01-9
.0460"	.71"	.156"	.040"	4-48	477-02-9
.062"	.71"	.156"	.058"	4-48	477-03-9
.0780"	.83"	.156"	.058"	4-48	477-04-9
.0938"	.83"	.156"	.100"	4-48	477-05-9
.1250"	.80"	.156"	.100"	4-48	477-06-9
.1562"	.80"	.156"	.100"	4-48	477-07-9
.1562"	.80"	.156"	.156"	M2.5	477-08-9
.1870"	.375"	.156"	.218"	4-48	477-09-9
.2188"	.375"	.156"	.218"	4-48	477-10-9
.2500"	.250"	.218"	.218"	4-48	477-11-9
.2812"	.250"	.218"	.218"	4-48	477-12-9
.3125"	.250"	.218"	.218"	4-48	477-13-9
.3438"	.250"	.218"	.218"	4-48	477-14-9
.3750"	.250"	.218"	.218"	4-48	477-15-9
.4060"	.250"	.218"	.218"	4-48	477-16-9
.4060"	.250"	.218"	.218"	M2.5	477-17-9
.4370"	.250"	.218"	.218"	4-48	477-18-9
.4680"	.250"	.218"	.218"	4-48	477-19-9
.5000"	.250"	.218"	.218"	4-48	477-20-9
.5310"	.250"	.218"	.218"	4-48	477-21-9
.5625"	.250"	.312"	.312"	4-48	477-22-9
.5937"	.250"	.312"	.312"	4-48	477-23-9
.6250"	.250"	.312"	.312"	4-48	477-24-9
.6250"	.250"	.312"	.312"	M2.5	477-25-9
.6560"	.250"	.312"	.312"	4-48	477-26-9
.687"	.250"	.312"	.312"	4-48	477-27-9
.7180"	.250"	.312"	.312"	4-48	477-28-9
.7500"	.250"	.312"	.312"	4-48	477-29-9
.7812"	.250"	.312"	.312"	4-48	477-30-9
.8125"	.250"	.312"	.312"	4-48	477-31-9
.8750"	.250"	.5"	.5"	4-48	477-32-9
.9375"	.250"	.5"	.5"	4-48	477-33-9
1.0000"	.250"	.5"	.5"	4-48	477-34-9
1.0625"	.250"	.5"	.5"	4-48	477-35-9
1.1250"	.250"	.5"	.5"	4-48	477-36-9
1.1785"	.250"	.5"	.5"	4-48	477-37-9
1.2500"	.250"	.5"	.5"	4-48	477-38-9



Dial Indicator Extension Rods & Sets

477 Series

SPECIFICATIONS

Length	Inch		Metric	
	Thread	Code No.	Thread	Code No.
1/2"	4-48	477-10-7	M2.5x0.45	477-10-6
3/4"	4-48	477-11-7	M2.5x0.45	477-11-6
1"	4-48	477-12-7	M2.5x0.45	477-12-6
1-1/4"	4-48	477-13-7	M2.5x0.45	477-13-6
1-1/2"	4-48	477-14-7	M2.5x0.45	477-14-6
1-3/4"	4-48	477-15-7	M2.5x0.45	477-15-6
2"	4-48	477-16-7	M2.5x0.45	477-16-6
2-1/2"	4-48	477-17-7	M2.5x0.45	477-17-6
3"	4-48	477-18-7	M2.5x0.45	477-18-6
4"	4-48	477-19-7	M2.5x0.45	477-19-6
6"	4-48	477-20-7	M2.5x0.45	477-20-6
Sets				
each of 1",2",3"	4-48	477-03-8	M2.5x0.45	477-04-8



FEATURES

- Use to gain extra length.
- 7/32" diameter points.
- Stainless Steel.

Indicator Probe Holders

500 Series

FEATURES

- Low Carbon Steel, Black Oxide plated
- .014-.040 chucking capacity

SPECIFICATIONS

Thread	Code No.
4-48	500-17-1
M2.5	500-17-0





Dial Test Indicators

501 / 502 / 511 / 512 Series

FEATURES

- Graduation: Inch .0001"; .0005"; Metric 0.002mm; 0.01mm
- Jeweled bearings
- Inch unit comes with $\varnothing 3/8"$ dovetail stems. Metric unit comes with $\varnothing 8$ mm dovetail stems
- Easy to read yellow face
- Horizontal models and Vertical models are available
- Ruby contact point

STANDARD ACCESSORIES

- Warranty card, Instruction manual, Calibration certificate



Vertical



Horizontal



3D Model

Full Set



Carbide tipped point
DIA. $\varnothing 2$ mm

Steel point
DIA. $\varnothing 1$ mm

Stem Dia.
Metric: 4mm
Inch: .157"

Knurled
Clamping Ring

Swivel Clamp
Metric: for $\varnothing 4$ mm, & $\varnothing 8$ mm Dia.
Inch: for $3/8"$, & .157" Dia.

Holding Bar
Metric: 9x9x100mm
Inch: .25"x.5"x4"

Base Set



Indicator

Carbide tipped point
 $\varnothing 2$ mm Dia.

Stem Dia.
Metric: $\varnothing 8$ mm
Inch: $\varnothing 3/8"$

Knurled
Clamping Ring

wrench

SPECIFICATIONS

Range	Resolution	Dial reading	Accuracy	Note	$\varnothing 32$ mm / $\varnothing 1.26"$ DIA.		$\varnothing 40$ mm / $\varnothing 1.57"$ DIA.	
					Code No.	Set Code No.	Code No.	Set Code No.
Inch								
.008"	.0001"	0-4-0	$\pm 0.001"$	Horizontal	501-78-3	501-78-7	-	-
.03"	.0005"	0-15-0	$\pm 0.005"$	Horizontal	501-73-3	501-73-8	-	-
.008"	.0001"	0-4-0	$\pm 0.001"$	Vertical	501-78-5	-	-	-
.03"	.0005"	0-15-0	$\pm 0.005"$	Vertical	501-73-5	-	-	-
.03"	.0005"	0-15-0	$\pm 0.005"$	Horizontal / Long Point	501-73-6	-	-	-
Metric								
0.2mm	0.002mm	0-100-0	0.004mm	Horizontal	501-02-2	501-02-7	502-02-2	502-02-7
0.5mm	0.01mm	0-25-0	0.013mm	Horizontal	501-05-2	501-05-7	502-05-2	502-05-7
0.8mm	0.01mm	0-40-0	0.013mm	Horizontal	501-08-2	501-08-7	502-08-2	502-08-7
1.0mm	0.01mm	0-50-0	0.013mm	Horizontal	501-10-2	501-10-7	502-10-2	502-10-7
0.2mm	0.002mm	0-100-0	0.004mm	Vertical	501-02-4	-	502-02-4	-
0.5mm	0.01mm	0-25-0	0.013mm	Vertical	501-05-4	-	502-05-4	-
0.8mm	0.01mm	0-40-0	0.013mm	Vertical	501-08-4	-	502-08-4	-
1.0mm	0.01mm	0-50-0	0.013mm	Vertical	501-10-4	-	502-10-4	-
G Series								
0.2mm	0.002mm	0-100-0	0.004mm	Horizontal	501-02-6	-	502-02-6	-
0.8mm	0.01mm	0-40-0	0.008mm	Horizontal	501-08-6	-	502-08-6	-
IP53 model								
0.2mm	0.002mm	0-100-0	0.004mm	Horizontal	511-02-6	-	512-02-6	-
0.8mm	0.01mm	0-40-0	0.013mm	Horizontal	511-08-6	-	512-08-6	-



Dial Test Indicators

501 / 502 / 511 / 512 Series



501-08-2 502-08-2
501-08-4 502-08-4
501-08-7 502-08-7
501-08-6 502-08-6
511-08-6 512-08-6



501-10-2 502-10-2
501-10-4 502-10-4
501-10-7 502-10-7



501-02-2 502-02-2
501-02-4 502-02-4
501-02-7 502-02-7
501-02-6 502-02-6
511-02-6 512-02-6

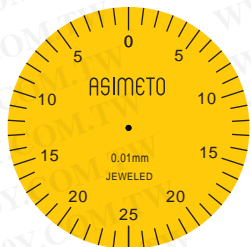

501-05-2 502-05-2
501-05-4 502-05-4
501-05-7 502-05-7



501-73-3 501-73-8
501-73-5
501-73-6



501-78-3
501-78-5
501-78-7

Dimension

Horizontal

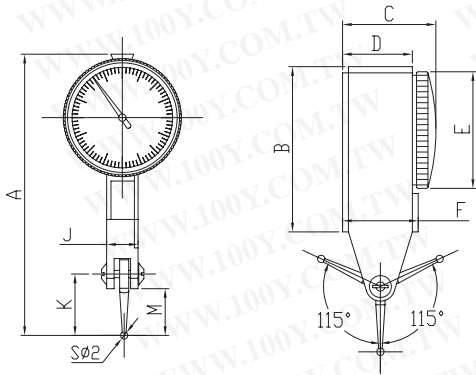

Vertical

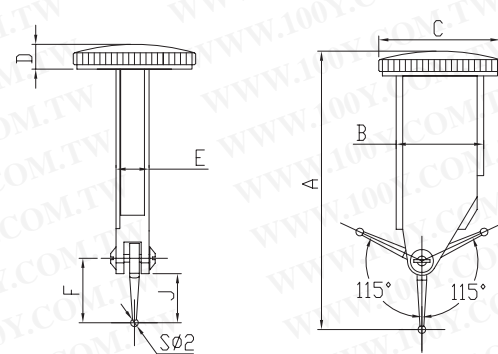

Grauation	A	B	C	D	E	F	J	K	M
	mm	mm	mm	mm	mm	mm	mm	mm	mm
Vertical									
0.002mm/.0001"	71	44	25	17	32	19	8.5	15	11
0.01mm/.0005"	78.6	45	27	19	32	21	8.5	18	14
Horizontal									
0.002mm/.0001"	69	23	32	8	8.5	15	11	-	-
0.01mm/.0005"	76	23	32	8	8.5	17	13	-	-

Remark: Refer to Page 118 for the detail length of contact point for different ranges test indicators



Extended Range Dial Test Indicators

503 / 504 Series

FEATURES

- Graduation:
 - Inch: .0001" / .0005" / .001"
 - Metric: 0.002mm / 0.01mm
- Jeweled bearing design and resistant to magnetic fields
- Stem diameter: Inch: 3/8", Metric: 8mm
- Carbide contact point swivel 210 degrees
- Horizontal and vertical models are available
- 30 and 38mm dial diameters are available

STANDARD ACCESSORIES

- Wrench
- Warranty card, Instruction manual, Calibration certificate



SPECIFICATIONS

Range	Graduation	Dial Reading	Accuracy	Note	Φ30mm / Φ1.18" Dia.	Φ38mm / Φ1.50" Dia.
					Code No.	Code No.
Inch						
.060"	.001"	0-15-0	±.0012"	Horizontal	503-06-1	-
.060"	.0005"	0-15-0	±.0012"	Horizontal	503-56-1	504-56-1
.060"	.001"	0-15-0	±.0012"	Vertical	503-06-3	-
.060"	.0005"	0-15-0	±.0012"	Vertical	503-56-3	504-56-3
Metric						
1.6mm	0.01mm	0-40-0	±0.02mm	Horizontal	503-56-0	504-56-0
1.6mm	0.01mm	0-40-0	±0.02mm	Vertical	503-56-2	504-56-2

Dimension

Horizontal

Vertical

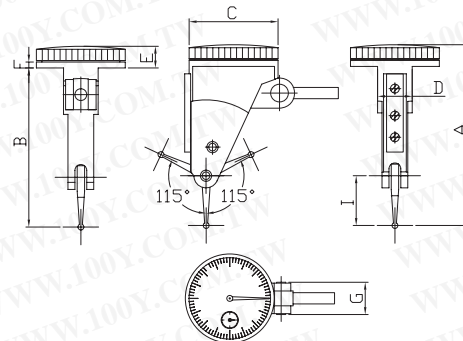
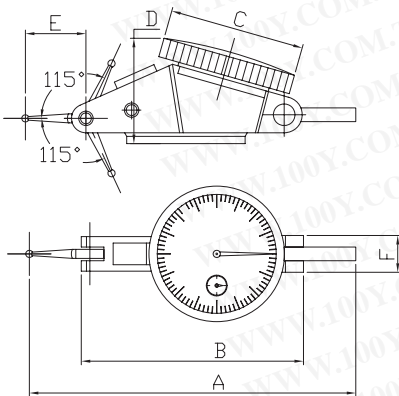

A	B	C	D	E	F
91mm	64mm	30/38mm	36mm	19.7mm	12.3mm

A	B	C	D	E	F	G
66mm	57.5mm	30/38mm	12mm	8.5mm	20mm	12.3mm



Extended Range Dial Test Indicator Sets

504 Series

SET #1

FEATURES

- Doubles the range of most of indicators
- Jeweled movement and easy to read dial
- Range: 0 – 0.060"
- Two dovetail stems and 3 contact points included: Stems: 3/8" & 5/32", Points: .04" (hardened steel), .08", .12" (tungsten carbide) x 5/8" long

STANDARD ACCESSORIES

- Calibration certificate, Instruction manual, Warranty card, Indicator, wrench
- Height Gauge Bar (1/4" x 1/2") w/Swivel Clamp w/5/32", 7/32", 1/4" holes
- Axial support w/3/8" Stem and Dovetail
- Reduction sleeve 3/8" to 5/32"
- Two dovetail Stems, 3/8" & 5/32"
- Three contact points: .04" (hardened steel), .08", .12" (Tungsten Carbide) x 5/8" long



504-81-1

SPECIFICATIONS

Range	Graduation	Dial Dia.	Accuracy	Indicator Code No.	Set Code No.
1.6mm	0.01mm	30mm	±0.002mm	503-56-0	504-81-0
.060"	.0005"	1.5"	±0.0012"	504-56-1	504-81-1
.060"	.0005"	1.0"	±0.0012"	503-56-1	504-81-3
.060"	.001"	1.0"	±0.0012"	503-06-1	504-81-5

SET #2

FEATURES

- Doubles the range of most of indicators
- Jeweled movement and easy to read dial
- Supplied with Xtra-Mag magnetic base
- Range: 0- .060", Graduation: .0005"
- Dial Reading 0-15-0, Dial Dia.: 1-5/16"
- 5/32" Stem, dovetail on front and back

STANDARD ACCESSORIES

- Calibration certificate, Instruction manual, Warranty card, Indicator , Wrench
- Xtra-Mag magnetic base with 2 universal ball sockets
- Micro-fine adjustment screw
- 3-9/16" extension arm
- Two dovetail Stems: 3/8" & 5/32"
- Three contact points: .04" (hardened steel), .08", .12" (Tungsten Carbide) x 5/8" long



504-82-1

SPECIFICATIONS

Range	Graduation	Dial Dia.	Accuracy	Indicator Code No.	Set Code No.
.060"	.0005"	1.5"	±0.0012"	504-56-1	504-82-1
1.6mm	0.01mm	38mm	±0.02mm	504-56-0	504-82-0



Digital Test Indicator

505 Series

FEATURES

- Resolution: 0.001mm/ .0001"
- Inch/Metric conversion
- With Ø8mm and Ø4mm dovetail stems
- Positive and negative measurement
- Tolerance setting
- With Ruby tipped contact point

STANDARD ACCESSORIES

- Warranty card, Instruction manual, Calibration certificate

SPECIFICATIONS

Inch		Metric		Code No.
Range	Accuracy	Range	Accuracy	
.02"	.0005"	0.5mm	0.02mm	505-01-0



Digital Radius Gauge

495 Series

FEATURES

- Resolution: 0.005mm / .0002"
- Inch/Metric conversion
- With 5 Bases :10mm,20mm,30mm,60mm,100mm.

STANDARD ACCESSORIES

- Warranty card, Instruction manual, Calibration certificate

SPECIFICATIONS

Range	Indicator	Accuracy	Code No.
R5-999.99mm	0-12.5mm/0.005mm	0.5mm	495-17-0





Centering Indicators

469 Series

FEATURES

- Graduation: .0005" / 0.01mm
- Provides a simplified method of centering a work piece or fixture on horizontal for vertical machines, internal or external diameters. Face of indicator remains stationary in any desired position while the machine spindle rotates, leaving the operator with both hands free to accurately position the machine table
- Shank Dia.: $\varnothing 3/8"$ / $\varnothing 10\text{mm}$
- Operating speed not to exceed 800 RPM
- Range:
 - Internal: $5/32"$ - $12"$ / 4 - 300mm
 - External: Up to $12"$ / 300mm

STANDARD ACCESSORIES

- 6 pcs Feeler Set, Center Locating Feeler, Warranty card, Instruction manual

SPECIFICATIONS

	Dial range	Accuracy	Code No.
Metric	0-3mm	0.005mm	469-00-6
Inch	0- .15"	.0002"	469-00-8

Parts

Description	Length	capacity	Code No.
6 pcs Feeler Set			469-01-1
ID Feeler	2"/50mm	4"/100mm	469-01-2
ID Feeler	4"/100mm	8"/200mm	469-01-3
ID Feeler	6"/150mm	12"/300mm	469-01-4
OD Feeler	2"/50mm	4"/100mm	469-01-5
OD Feeler	4"/100mm	8"/200mm	469-01-6
OD Feeler	6"/150mm	12"/300mm	469-01-7
Center Locating Feeler			469-01-8
Feeling Rod			469-01-9



469-00-6



Zero Set Holder

500 Series

FEATURES

- The ZeroSet fits all dovetail equipped Indicators, and is used for checking Set-Ups.
- Checks the alignment of the centers of round materials in relation to the cutting head.
- Speeds set up operations enormously.
- Equipped with a spindle post with 1/4", 3/8", and 1/2" diameters, and has an effective measuring range of 3/8" thru 9".
- Test indicator is not included and is optional.

SPECIFICATIONS

Code No.

500-15-0

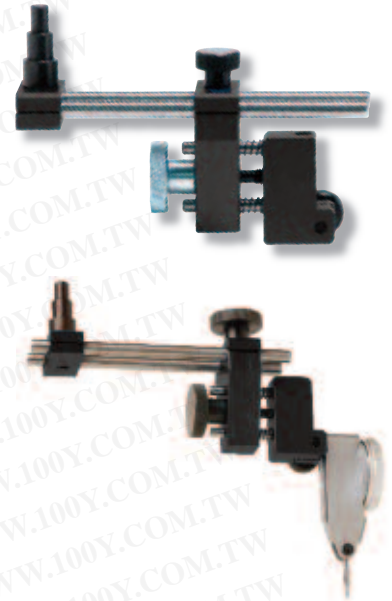

Zero Set Universal Attachment

500 Series



FEATURES

- For use with any dovetail test indicator allowing a multitude of positioning possibilities in either direction
- Angles up to 90 degrees on either side.
- Allows for an infinite range of measurements over an extensive area.
- Test indicator is not included and is optional.

SPECIFICATIONS

Code No.

500-16-0





Axial Support Bracket

500 Series



FEATURES

- Used for mounting Indicators with dovetails or rods.
- 3/8" diameter body for secure clamping, with 5-1/2" overall reach.
- Bends in many directions

SPECIFICATIONS

Shank Dia.	Overall Length	Code No.
3/8"	5 1/4"	500-26-0



Double-Jointed Dovetail Holder

500 Series

FEATURES

- Brass Setting Nut allows orientation of the indicator in a full 360 degrees, with secure clamping.
- It also allows a fine adjustment for the indicator of .060" up and down.
- 3/8" diameter body for secure clamping
- 4-1/2" overall reach
- Fits all dovetail equipped Indicators

SPECIFICATIONS

Shank Dia.	Overall Length	Code No.
3/8"	4 3/4"	500-27-0



Surface Gauges

500 Series

FEATURES

- Base hardened.
- Bottom grooved for cylindrical work.
- Front end recessed for depressing spindle below base level.
- Knurled thumb screw in rocker for extra fine adjustment.
- Includes scriber.
- Universal Surface Gauge includes clamp attachment (with 5/32" and 15/64" holes) for holding indicators, scribers, etc.

SPECIFICATIONS

Description	Spindles	Base dimensions (L x W x H)	Code No.
Small Toolmaker's Surface Gauge	4" and 7"	2-1/4 x 1-5/8 x 7/8"	500-28-0
Universal Surface Gauge	9" and 12"	3-1/8 x 2-3/8 x 1-1/8"	500-29-0





Spring-Loaded Tension Clamps

500 Series

FEATURES

- A complete range of sizes for all applications.
- Used for setting up and fixturing all types of instruments.
- Available with clamping ranges from 5/32" to 1/2".
- Overall length for all sizes is 1-3/4".
- Steel with Black Oxide finish.
- New Stainless Steel sizes also.



SPECIFICATIONS

Clamp Hole	End Hole	Code No.	
		Steel	Stainless Steel
5/16"	5/32"	500-30-0	500-40-0
5/16"	1/4"	500-30-1	500-40-1
3/8"	1/4"	500-30-2	500-40-2
1/4"	1/4"	500-30-3	500-40-3
5/16"	5/16"	500-30-4	500-40-4
3/8"	5/16"	500-30-5	500-40-5
3/8"	3/8"	500-30-6	500-40-6
1/2"	3/8"	500-30-7	500-40-7
1/2"	5/16"	500-30-8	500-40-8



Clamps with Dovetail

500 Series



500-36-1



500-36-2



500-36-0



500-36-4

FEATURES

- For any indicator equipped with rods or dovetails.
- Used to fixture Indicators on Surface Gauge, Gauge Stands, Magnetic Bases, Height Gauge, Transfer Stands, and many others.
- Steel with Black Oxide finish.

SPECIFICATIONS

Mounting Hole	Code No.
3/8" and 7/32"	500-36-0
3/8 and 1/4	500-36-1
3/8 and 5/32	500-36-2
7/32 and 5/32	500-36-3
1/4 and 1/8 plus adjustable hole up to 1/4	500-36-4



500-36-3



Inside/Outside Diameter Groove Gauges

500 Series

FEATURES

- A quick way to inspect steps, counterbores, keyways and face O-ring grooves
- Available in 0-6" and 6-12" ranges
- Black Anodized Aluminum



SPECIFICATIONS

Range	Code No.
0-6"	500-37-0
6-12"	500-38-0

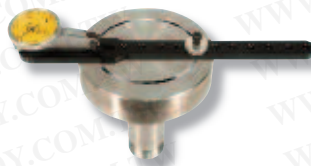

Dial Indicator Depth Bases

500 Series

FEATURES

- Ground flat and parallel on both top and bottom surfaces.
- Set screw in bases holds Indicator in place.
- Black Oxide plated.



SPECIFICATIONS

Base length	Dia. of hole	Code No.
65mm	3/8"	500-39-1
100mm	3/8"	500-39-3
65mm	8mm	500-39-0
100mm	8mm	500-39-2

Dial Holders

500 Series

FEATURES

- Measuring depth with a dial indicator

SPECIFICATIONS

Base length	Dia. of hole	Measuring rods QTY	Code No.
63.5mm	3/8"	10 PCS	500-90-1
100mm	3/8"	10 PCS	500-90-3
63.5mm	8mm	10 PCS	500-90-0
100mm	8mm	10 PCS	500-90-2



Universal Dovetail Indicator Holder

500 Series

FEATURES

- 1/4" shank diameter with 3" reach.
- This spring loaded holder locks in any of (4) 90 degree quadrants, and allows many variable angles of holding.
- Brass contact will not scar Indicator.
- Fits all dovetail equipped Indicators.
- Stainless Steel

SPECIFICATIONS

Code No.
500-41-0





Optional Accessories for ASIMETO Test Indicators

500 Series

Contact Points



			Steel	Carbide	Ruby
Indicator Range	Tipp Dia.	Length	Code No.	Code No.	Code No.
1mm/0.01mm	Φ1mm	21mm	500-11-1	-	-
	Φ2mm	21.5mm	500-12-1	500-12-2	500-12-3
	Φ3mm	22mm	500-13-1	500-13-2	-
0.8mm/0.01mm	Φ1mm	15.9mm	500-51-1	-	-
	Φ2mm	17.3mm	500-52-1	500-52-2	500-52-3
0.5mm/0.01mm	Φ3mm	17.8mm	500-53-1	500-53-2	-
.03"/.0005"	Φ1mm	15.9mm	500-61-1	-	-
	Φ2mm	16.2mm	500-62-1	500-62-2	500-62-3
	Φ3mm	16.7mm	500-63-1	500-63-2	-
0.2mm/0.002mm	Φ1mm	15.9mm	500-71-1	-	-
	Φ2mm	16.2mm	500-72-1	500-72-2	500-72-3
.008"/.0001"	Φ3mm	16.7mm	500-73-1	500-73-2	-
1.6mm/0.01mm	Φ1mm	21.3mm	500-81-1	-	-
	Φ2mm	22.6mm	500-84-1	-	500-82-3
	Φ3mm	22.3mm	500-83-1	500-83-2	-
.06"/.001" .06"/.0005"	Φ1mm	21.3mm	500-81-1	-	-
	Φ2mm	21.8mm	500-82-1	500-82-2	500-82-3
	Φ3mm	22.3mm	500-83-1	500-83-2	-

Dovetail Stem Sets



Knurled Clamping Ring

Size	Code No.
3/8"	500-31-1
5/32"	500-31-3
8mm	500-31-0
6mm	500-31-2

Swivel Clamps



Description	Code No.
For 3/8" & 5/32" dia. Dovetail Stem	500-25-1
For 8mm & 6mm dia. Dovetail Stem	500-25-2

Holding Bars



500-21-0

500-21-1

Size	Code No.
.25x.5", Length: 2"	500-21-1
.25x.5", Length: 4"	500-21-3
9x9mm, Length: 50mm	500-21-0
9x9mm, Length: 100mm	500-21-2
10x12mm, Length: 50mm	500-21-4
10x12mm, Length: 100mm	500-21-6

Centering Holders

- Allows large diameter cylinders or holes to be centered



Description	Code No.
8mm Dia. Stem	500-35-0
.25" Dia. Stem	500-35-1



Dial Gauge Stands

670 Series

FEATURES

- Both column and metal stage are hardened and precision lapped
- With $\varnothing 8\text{mm}$ H7 clamping hole



670-01-0



670-11-0

SPECIFICATIONS

Size	Flatness	Pillar	Verticality	Measuring range	Code No.
$\varnothing 50\text{mm}$	0.002mm	207 x $\varnothing 35\text{mm}$	0.03mm	100mm	670-01-0
$\varnothing 50\text{mm}$	0.002mm	170 x $\varnothing 20\text{mm}$	0.03mm	100mm	670-02-0
80 x 80mm	0.002mm	180 x $\varnothing 25\text{mm}$	0.03mm	100mm	670-03-0
115 x 97mm	0.002mm	Primary: 260 x $\varnothing 27.5\text{mm}$ secondary: 150 x $\varnothing 20\text{mm}$	0.03mm	200mm	670-04-0
60 x 68mm	0.002mm	207 x $\varnothing 35\text{mm}$	0.03mm	100mm	670-11-0
98 x 115mm	0.005mm	235 x $\varnothing 35\text{mm}$	0.05mm	100mm	670-12-0

Precision Granite Stands

670 Series

FEATURES

- With adjustable arm
- Granite measuring surface and base
- With $\varnothing 8\text{mm}$ H7 clamping hole



670-31-0



670-22-0

SPECIFICATIONS

Size	Flatness	Pillar	Verticality	Measuring range	Code No.
Smooth Column					
150 x 100 x 40	0.002mm	200 x $\varnothing 20\text{mm}$	0.03mm	150mm	670-13-0
150 x 100 x 40	0.002mm	170 x $\varnothing 18\text{mm}$	0.03mm	1000mm	670-14-0
150 x 150 x 50	0.002mm	300 x $\varnothing 30\text{mm}$	0.03mm	250mm	670-31-0
150 x 230 x 50	0.002mm	300 x $\varnothing 30\text{mm}$	0.03mm	250mm	670-32-0
230 x 300 x 90	0.002mm	300 x $\varnothing 30\text{mm}$	0.03mm	250mm	670-33-0
Screw Column					
200 x 150 x 50	0.002mm	300 x $\varnothing 30\text{mm}$	0.03mm	250mm	670-22-0
300 x 200 x 50	0.002mm	300 x $\varnothing 30\text{mm}$	0.03mm	250mm	670-23-0



Magnetic Bases

601 Series

FEATURES

- Accepts test indicators with dovetail clamping mechanism
- Dial gauges can be held by the 3/8" or 8mm diameter stem or by the lug backing plate
- The rotary knob switches natural magnet on or off
- The precision surfaces and the bottom V are securely fastened to the ferrous work piece or machine table when the rotary knob is in the on position
- #601-02-0/1 with Fine Adjustment



601-01-1

601-02-1

SPECIFICATIONS

Magnetic Power	Magnetic Base	Main Stem		Sub Pole			Remark	Inch	Metric
	(L X W X H)	Dia.	Length	Dia.	Length	Dia. of hole		Code No.	Code No.
80 kgf	60x50x55mm	Φ12mm	176mm	Φ10mm	165mm	Φ3/8" / Φ8mm		601-01-1	601-01-0
80 kgf	60x50x55mm	Φ12mm	176mm	Φ10mm	150mm	Φ3/8" / Φ8mm	with a fine adjustment	601-02-1	601-02-0
100 kgf	73x50x55mm	Φ12mm	190mm	Φ10mm	150mm	Φ3/8" / Φ8mm	Metal switch	601-03-1	601-03-0

Forced Locking Magnetic Bases

604 Series

FEATURES

- Accepts test indicators with dovetail clamping mechanism
- Dial gauges can be held by the 3/8" or 8mm diameter stem or by the lug backing plate
- New design, Holding more solid and reliable, more stable performance, higher accuracy
- The rotary knob switches natural magnet on or off
- The precision surfaces and the bottom V are securely fastened to the ferrous work piece or machine table when the rotary knob is in the on position



604-02-0

SPECIFICATIONS

Magnetic Power	Magnetic Base	Main Stem		Sub Pole		Dia. of Hole		
	(L X W X H)	Dia.	Length	Dia.	Length		Slot	Code No.
80 kgf	60x50x55mm	Φ12mm	180mm	Φ10mm	160mm	Φ3/8" / Φ8mm	6.5mm	604-01-0
80 kgf	60x50x55mm	Φ14mm	203mm	Φ12mm	165mm	Φ3/8" / Φ8mm	6.5mm	604-02-0
100 kgf	73x50x55mm	Φ16mm	250mm	Φ16mm	200mm	Φ3/8" / Φ8mm	6.5mm	604-03-0
100 kgf	117x50x55mm	Φ18mm	350mm	Φ16mm	200mm	Φ3/8" / Φ8mm	6.5mm	604-04-0



Flexible Arm Magnetic Bases

601 Series

FEATURES

- Accepts test indicators with dovetail clamping mechanism
- Dial gauges can be held by the 3/8" or 8mm diameter stem or by the lug backing plate
- The multi-flex arm is turned rigid when the lever is activated
- The rotary knob switches natural magnet on or off
- The precision surfaces and the bottom V are securely fastened to the ferrous work piece or machine table when the rotary knob is in the on position
- 132 lb / 60kg magnetic pull

SPECIFICATIONS

Magnetic Power	Magnetic Base (L X W X H)	Main Stem Length	Dia. of Hole	Code No.
60 kgf	60x50x55mm	360mm	Φ8mm	601-11-0
60 kgf	60x50x55mm	360mm	Φ3/8"	601-11-1



601-11-0

Articulating Arm Magnetic Bases

602 Series

FEATURES

- Accepts test indicators with dovetail clamping mechanism
- Dial gauges can be held by the 3/8" or 8mm diameter stem or by the lug backing plate
- The rotary knob switches natural magnet on or off
- The precision surfaces and the bottom V are securely fastened to the ferrous work piece or machine table when the rotary knob is in the on position



602-01-6



602-31-0

SPECIFICATIONS

Magnetic Power	Magnetic Base (L X W X H)	Height	Dia. of Hole	Slot	Code No.
80 kgf	60x50x55mm	390mm	Φ3/8" / Φ8mm	6.5mm	602-31-0
100 kgf	73x50x55mm	410mm	Φ3/8" / Φ8mm	6.5mm	602-01-6



Articulating Arm Magnetic Bases

602 Series

FEATURES

- Accepts test indicators with dovetail clamping mechanism
- Dial gauges can be held by the 3/8" or 8mm diameter stem or by the lug backing plate
- Arm has 3 articulating joints that can be locked with the single hand knob
- The rotary knob switches natural magnet on or off
- The precision surfaces and the bottom V are securely fastened to the ferrous work piece or machine table when the rotary knob is in the on position

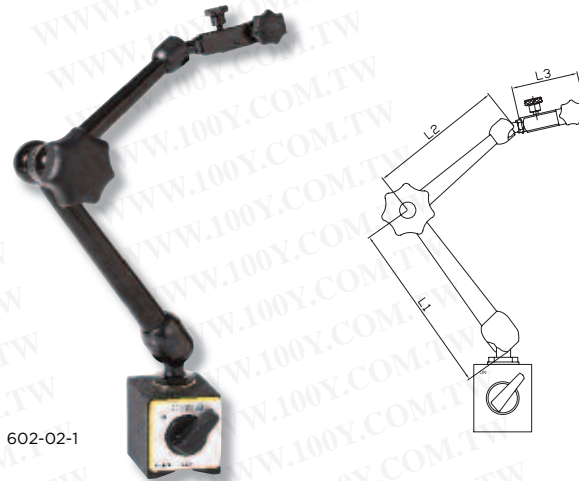

602-02-1

SPECIFICATIONS

Magnetic Power	Magnetic Base (L X W X H)	Height	Dia. of Hole	L1	L2	L3	Slot	Code No.
30 kgf	40x30x35mm	215mm	Φ3/8" / Φ8mm	65mm	55mm	60mm	6.5mm	602-01-1
80 kgf	60x50x55mm	350mm	Φ3/8" / Φ8mm	110mm	110mm	60mm	6.5mm	602-02-1
80 kgf	60x50x55mm	440mm	Φ3/8" / Φ8mm	150mm	140mm	60mm	6.5mm	602-03-1
130 kgf	117x50x55mm	690mm	Φ3/8" / Φ8mm	345mm	230mm	60mm	6.5mm	602-05-1

FEATURES

- Accepts test indicators with dovetail clamping mechanism
- Dial gauges can be held by the 3/8" or 8mm diameter stem or by the lug backing plate
- Arm has 3 articulating joints that can be locked with the single hand knob
- The rotary knob switches natural magnet on or off
- The precision surfaces and the bottom V are securely fastened to the ferrous work piece or machine table when the rotary knob is in the on position



602-05-3

602-04-3

SPECIFICATIONS

Magnetic Power	Magnetic Base (L X W X H)	Height	Dia. of Hole	Code No.
40 kgf	36x30x35mm	187mm	Φ3/8" / Φ8mm	602-01-3
60 kgf	58x50x55mm	255mm	Φ3/8" / Φ8mm	602-02-3
80 kgf	60x50x55mm	340mm	Φ3/8" / Φ8mm	602-03-3
100 kgf	74x50x55mm	460mm	Φ3/8" / Φ8mm	602-04-3
40 kgf	DIA40X80mm	255mm	Φ3/8" / Φ8mm	602-05-3



Hydraulic Magnetic Bases

603 Series

FEATURES

- Accepts test indicators with dovetail clamping mechanism
- Dial gauges can be held by the 3/8" or 8mm diameter stem or by the lug backing plate
- The rotary knob switches natural magnet on or off
- The precision surfaces and the bottom V are securely fastened to the ferrous work piece or machine table when the rotary knob is in the on position

SPECIFICATIONS

Magnetic Power	Magnetic Base (L X W X H)	Height	Dia. of Hole	Slot	Code No.
80 kgf	60x50x55mm	385mm	Φ3/8" / Φ8mm	6.5mm	603-01-0
100 kgf	73x50x55mm	685mm	Φ3/8" / Φ8mm	6.5mm	603-02-0



603-01-0

Magnetic Bases

600 Series

Magnetic Power	Dimension	Thread size	Code No.
60kgf	60x50x55mm	M8	600-01-1
80kgf	60x50x55mm(Metal switch)	M8	600-01-2
100kgf	73x50x55mm(Metal switch)	M8	600-01-3



600-01-1

Permanent Magnetic Base

601 Series

FEATURES

- With permanent magnetic base, without On/Off switch
- Dovetail groove included

SPECIFICATIONS

Magnetic Power	Main body	Main Stem Length	Dia. of Hole	Slot	Code No.
			Hole	Slot	
17 kgf	Ø30x25mm	85mm	Φ8 / Φ6mm	6mm	601-12-0



601-12-0

Bore Gauges

125	Dial Bore Gauges
126	Large Diameter Dial Bore Gauges
126	Extension Rods
127	Digital Bore Gauges
129	Bore Gauge Zero Checkers
129	Telescoping Gauges

Dial Bore Gauges

483 / 484 Series

FEATURES

- Moveable probe pin with carbide ball
- .24-.4" / 6-10mm range is with fixed anvils
- .4-.74" / 10-18mm range is with plate guide and fixed anvils
- .7-1.4" / 18-35mm range is with canister guide and fixed anvils
- Over 1.4" / 35mm range is with wheel guide and inserting anvils

STANDARD ACCESSORIES

- Refer to the table
- Warranty card, Instruction manual, Calibration certificate



.24-.4" / 6-10mm



.4-.74" / 10-18mm
Plate guide



.7-1.4" / 18-35mm
Canister guide



Over 1.4" / 35mm
Wheel guide



484-22-0

SPECIFICATIONS

Range	Graduation	Dial Travel	Accuracy	Number of Anvils	Number of Spacers	Number of Sub-anvils	Probe Depth	Code No.
Inch								
.24-.4"	.0001"	.05" (AGD1)	±0.0002"	9	-	-	2"	483-11-1
.4-.7"	.0001"	.05" (AGD1)	±0.0003"	9	1	-	4"	483-12-1
.7-1.5"	.0001"	.05" (AGD2)	±0.0003"	10	2	-	6"	483-21-1
1.4-2.4"	.0001"	.05" (AGD2)	±0.0003"	6	4	-	6"	483-22-1
2-6"	.0001"	.05" (AGD2)	±0.0003"	11	4	1	6"	483-31-1
6-10"	.0001"	.05" (AGD2)	±0.0003"	6	6	1	16"	483-32-1
10-16"	.0001"	.05" (AGD2)	±0.0003"	6	6	2	16"	483-33-1
Metric								
6-10mm	0.001mm	1mm (AGD1)	±0.005mm	9	-	-	40mm	483-11-0
10-18mm	0.001mm	1mm (AGD1)	±0.007mm	9	1	-	100mm	483-12-0
18-35mm	0.001mm	1mm (AGD2)	±0.007mm	9	1	-	150mm	483-21-0
35-50mm	0.001mm	1mm (AGD2)	±0.007mm	4	4	-	150mm	483-22-0
50-160mm	0.001mm	1mm (AGD2)	±0.007mm	12	4	1	150mm	483-31-0
160-250mm	0.001mm	1mm (AGD2)	±0.007mm	5	5	1	400mm	483-32-0
250-400mm	0.001mm	1mm (AGD2)	±0.007mm	5	5	2	400mm	483-33-0
Metric								
6-10mm	0.01mm	3mm (AGD1)	±0.015mm	9	-	-	40mm	484-11-0
10-18mm	0.01mm	3mm (AGD1)	±0.015mm	9	1	-	100mm	484-12-0
18-35mm	0.01mm	3mm (AGD2)	±0.020mm	9	2	-	150mm	484-21-0
35-50mm	0.01mm	3mm (AGD2)	±0.020mm	4	4	-	150mm	484-22-0
50-160mm	0.01mm	3mm (AGD2)	±0.025mm	12	4	1	150mm	484-31-0
160-250mm	0.01mm	3mm (AGD2)	±0.025mm	5	5	1	400mm	484-32-0
250-400mm	0.01mm	3mm (AGD2)	±0.025mm	5	5	2	400mm	484-33-0
400-600mm	0.01mm	3mm (AGD2)	±0.025mm	5	5	2	400mm	484-34-0
Set								
Range	Graduation	Individual Holes			Indicator		Code No.	
18-160mm	0.01mm	18-35mm, 35-50mm, 50-160mm			402-03-2 3mmx0.01mm		484-63-8	
18-160mm	0.001mm	18-35mm, 35-50mm, 50-160mm			402-01-2 1mmx0.001mm		483-63-8	

Large Diameter Dial Bore Gauges

484 Series

FEATURES

- Carbide tipped contact point, wheel guide
- Equipped with dial indicator #402-10-2

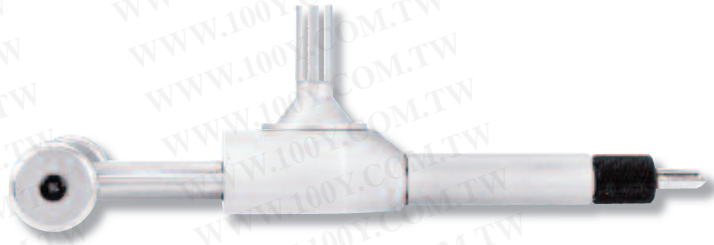

SPECIFICATIONS

Range	Graduation	Dial Travel	Rod Travel	Number of Anvil	Number of Spacers	Number of Sub-anvil	Probe Depth	Code No.
18-50mm	0.01mm	10mm	1.5mm	8	2	1	150mm	484-41-0
30-100mm	0.01mm	10mm	1.8mm	5	3	2	150mm	484-42-0
50-100mm	0.01mm	10mm	4mm	10	2	-	200mm	484-43-0
100-160mm	0.01mm	10mm	4mm	7	4	-	300mm	484-44-0
100-300mm	0.01mm	10mm	3mm	6	4	2	250mm	484-45-0
160-250mm	0.01mm	10mm	4mm	5	4	2	400mm	484-46-0
250-450mm	0.01mm	10mm	6mm	5	4	2	500mm	484-47-0
450-700mm	0.01mm	10mm	8mm	5	4	4	500mm	484-48-0
700-1000mm	0.01mm	10mm	8mm	5	4	5	500mm	484-49-0

Extension Rods

480 Series

FEATURES

- After the installation can be used to measure deep hole size
- Extension rod length can be up to 40" / 1000mm
- The use of single long extension rod will be better than connecting of multiple short Extension Rod

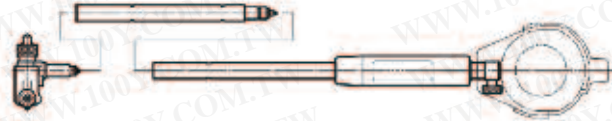

SPECIFICATIONS

Length	For Range	Code No.	For Range	Code No.	For Range	Code No.
4.92" / 125mm	.7" - 1.5" / 18 - 35mm	480-01-0	1.4" - 2.4" / 35 - 50mm 2" - 6" / 50 - 160mm	480-01-1	6" - 10" / 160 - 250mm 10" - 16" / 250 - 400mm	480-01-2
9.84" / 250mm	.7" - 1.5" / 18 - 35mm	480-02-0	1.4" - 2.4" / 35 - 50mm 2" - 6" / 50 - 160mm	480-02-1	6" - 10" / 160 - 250mm 10" - 16" / 250 - 400mm	480-02-2
19.69" / 500mm	.7" - 1.5" / 18 - 35mm	480-03-0	1.4" - 2.4" / 35 - 50mm 2" - 6" / 50 - 160mm	480-03-1	6" - 10" / 160 - 250mm 10" - 16" / 250 - 400mm	480-03-2
29.53" / 750mm	-	-	1.4" - 2.4" / 35 - 50mm 2" - 6" / 50 - 160mm	480-04-1	6" - 10" / 160 - 250mm 10" - 16" / 250 - 400mm	480-04-2
39.37" / 1000mm	-	-	1.4" - 2.4" / 35 - 50mm 2" - 6" / 50 - 160mm	480-05-1	6" - 10" / 160 - 250mm 10" - 16" / 250 - 400mm	480-05-2

Digital Bore Gauges

485 / 486 Series

FEATURES

- Resolution: .00005" / 0.002mm / 0.001mm
- Dynamic carbide contact point
- Digital gauges has analog sweep display to determine minimum reading
- .24-.4"/6-10mm range is with fixed anvils
- .4-.74"/10-18mm range is with plate guide and fixed anvils
- .7-1.4"/18-35mm range is with canister and fixed anvils
- Over 1.4"/35mm range is with wheel guide and inserting anvils

STANDARD ACCESSORIES

- Refer to the table
- Warranty card, Instruction manual, Calibration certificate



Metric Range	Number of Anvils	Number of Spacers	Metric Range	Number of Anvils	Number of Spacers	Accuracy	Probe Depth	Inch Code No.	Metric Code No.
.24-.4"	9	-	6-10mm	9	-	±0.012mm	2"/40mm	485-11-1	485-11-0
.4-.7"	9	1	10-18mm	9	1	±0.012mm	4"/100mm	485-12-1	485-12-0
.7-1.5"	10	2	18-35mm	9	2	±0.015mm	6"/150mm	485-21-1	485-21-0
1.4-2.4"	6	3	35-50mm	4	4	±0.015mm	6"/150mm	485-22-1	485-22-0
2-6"	11	3	50-160mm	12	4	±0.018mm	6"/150mm	485-31-1	485-31-0
6-10"	6	5	160-250mm	5	5	±0.018mm	16"/400mm	485-32-1	485-32-0
10-16"	6	5	250-400mm	5	5	±0.018mm	16"/400mm	485-33-1	485-33-0

Metric Range	Number of Anvils	Number of Spacers	Accuracy	Probe Depth	Metric Code No.
6-10mm	9	-	±0.005mm	2"/40mm	486-11-0
10-18mm	9	1	±0.005mm	4"/100mm	486-12-0
18-35mm	9	2	±0.007mm	4"/100mm	486-21-0
35-50mm	4	4	±0.007mm	6"/150mm	486-22-0
50-160mm	12	4	±0.007mm	6"/150mm	486-31-0
160-250mm	5	5	±0.007mm	16"/400mm	486-32-0
250-400mm	5	5	±0.007mm	16"/400mm	486-33-0

Accessories

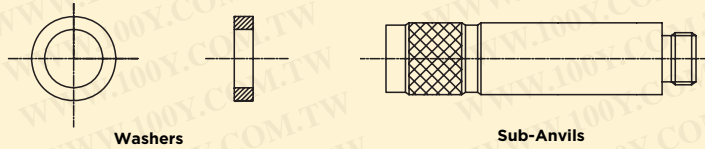

Washers

Sub-Anvils

Metric Washers and Sub-Anvils

Washers (mm)							Sub-Anvils (mm)		
Range	Qty.	#1	#2	#3	#4	#5	Qty.	#1	#2
6-10mm									
10-18mm	1	0.5							
18-35mm	2	0.5	1						
35-50mm	4	0.5	1	2	3				
50-160mm	4	0.5	1	2	3		1	55	
160-250mm	5	0.5	1	2	3	6	1	50	
250-400mm	5	0.5	1	2	3	6	2	50	100

Inch Washers and Sub-Anvils

Washer Dimensions (in)							Sub-Anvils (in)			
Range	Washer Qty.	#1	#2	#3	#4	#5	#6	Extension Rod Qty.	#1	#2
.24-.4"										
.4-.7"	1	0.02								
.7-1.5"	2	0.02	0.04							
1.4-2.4"	4	0.02	0.04	0.08	0.12					
2-6"	4	0.02	0.04	0.08	0.12			1	2	
6-10"	6	0.02	0.04	0.08	0.1	0.2	0.3	1	2	
10-16"	6	0.02	0.04	0.08	0.1	0.2	0.3	2	2	4

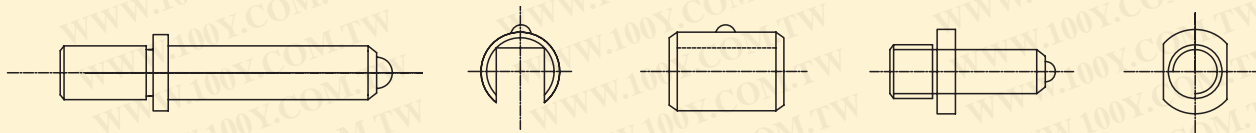

Adjustment Anvils

Metric Adjustment Anvils

Range Anvils Range (mm)													
Range	Qty.	#1	#2	#3	#4	#5	#6	#7	#8	#9	#10	#11	#12
6-10mm	9	6	6.5	7	7.5	8	8.5	9	9.5	10			
10-18mm	9	10	11	12	13	14	15	16	17	18			
18-35mm	9	18	20	22	24	26	28	30	32	34			
35-50mm	4	35	40	45	50								
50-160mm	12	50	55	60	65	70	75	80	85	90	95	100	105
160-250mm	5	160	170	180	190	200							
250-400mm	5	250	260	270	280	290							

Inch Adjustment Anvils

Range Anvils Range (in)												
Range	Qty.	#1	#2	#3	#4	#5	#6	#7	#8	#9	#10	#11
.24-.4"	9	0.24	0.26	0.28	0.3	0.32	0.34	0.36	0.38	0.4		
.4-.7"	9	0.4	0.44	0.48	0.52	0.58	0.62	0.64	0.68	0.7		
.7-1.5"	10	0.7	0.78	0.86	0.94	1.02	1.1	1.18	1.26	1.34	1.42	
1.4-2.4"	6	1.4	1.6	1.8	2	2.2	2.4					
2-6"	11	2	2.2	2.4	2.6	2.8	3	3.2	3.4	3.6	3.8	4
6-10"	6	6	6.4	6.8	7.2	7.6	8					
10-16"	6	10	10.4	10.8	11.2	11.6	12					

Bore Gauge Zero Checkers

483 Series

FEATURES

- The Bore Gauge Zero Checker allows easy zero adjustment of dial bore gauges with ranges of 18mm (.7") through 400mm (16") using gauge blocks
- High Accuracy and stable performance
- Interchangeable Supporting Blocks is for setting of various bore gauge

SPECIFICATIONS

Description	Code No.
18mm - 400mm / .7" - 16"	483-00-2
Interchangeable Supporting Blocks	483-50-0

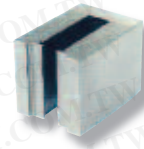

483-50-0

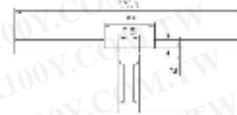

483-00-2



Telescoping Gauges

487 Series

FEATURES

- Spring-loaded plunger expands within the bore (or groove), allowing determination of the internal diameter
- With a knurled clamp



487-86-9

SPECIFICATIONS

	Inch	Metric				
Model	Range	Range	Depth	Code No.	Depth	Code No.
A	5/16" - 1/2"	8-12.7mm	4.2"/107mm	487-01-1	12"/300mm	487-01-3
B	1/2" - 3/4"	12.7-19mm	4.4"/112mm	487-02-1	12"/300mm	487-02-3
C	3/4" - 1-1/4"	19-32mm	4.4"/112mm	487-03-1	12"/300mm	487-03-3
D	1-1/4" - 2-1/8"	32-54mm	5.85"/150mm	487-04-1	12"/300mm	487-04-3
E	2-1/8" - 3-1/2"	54-90mm	5.85"/150mm	487-05-1	12"/300mm	487-05-3
F	3-1/2" - 6"	90-150mm	5.85"/150mm	487-06-1	12"/300mm	487-06-3
SETS						
6 pcs (A, B, C, D, E, F)	5/16"-6"	8-150mm		487-86-9		
5 pcs (B, C, D, E, F)	1/2"-6"	12.7-150mm		487-85-9		
4 pcs (A, B, C, D)	5/16"-2-1/8"	8-54mm		487-84-9		

Other Gauges

131	Protractors	138	CNC Tool Setting Gauges
131	Universal Bevel Protractors	139	Angle Gauges
131	Universal Angle Protractor	140	Thread Pitch Gauges
132	Dial Protractor	140	Center Gauge
132	Digital Protractor	141	Radius Gauges
133	Depth and Angle Gauges	141	Spring Dividers and Calipers
133	Combination Square Sets	142	Digital Protractors - Level Type
134	Steel Squares	142	Precision Levels
134	Granite Squares	143	High Precision Metric Parallels
135	Straight Knife Edges	143	Precision Parallel Sets
135	5-pcs Square Set	144	Granite Surface Plates
135	Die Makers Square Set	144	Granite Plate Stands
136	4-Way V-Blocks	145	Electronic Edge Finders
136	Cast Vee Blocks	145	Edge Finders
136	1-2-3, 2-3-4 & 2-4-6 Blocks	146	Automatic Weld Size Welding Gauge
137	Magnetic V-Blocks	146	Bridge Cam Welding Gauge
137	V-Blocks with Clamp	147	Universal Sliding Bevel
137	Magnetic Base Protractor	147	American Standard & Wire Gauges
138	Round Bar Center Finder	147	Countersink Angle Gauge
138	Wiggler Sets	147	Sine Bar Riser Kit

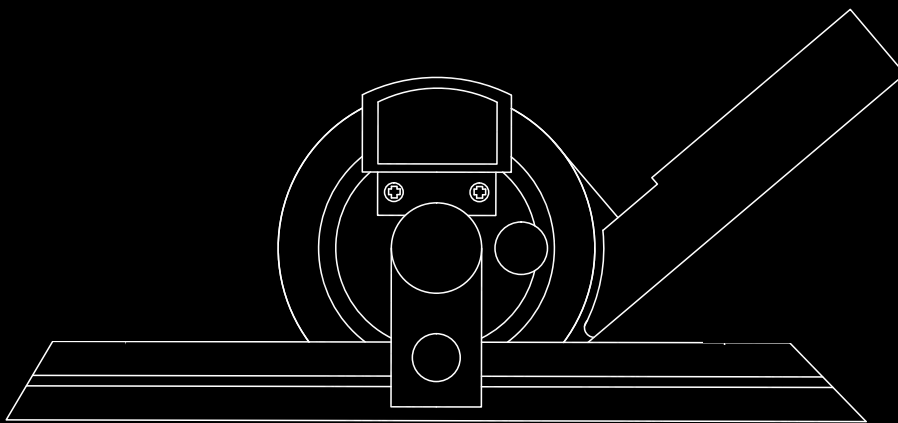

Protractors 490 Series

FEATURES

- Graduation: 1°
- Base and scale are stainless steel
- 150mm/6" arm, Ø85mm protractor
- Accuracy: ±5 min

SPECIFICATIONS

Description	Code No.
Protractor Resolution: 0°-90°, 90°-180°, 180°-90°, 90°-0°	490-01-1
Semi-circle: 0°-180°, 180°-0°	490-01-2

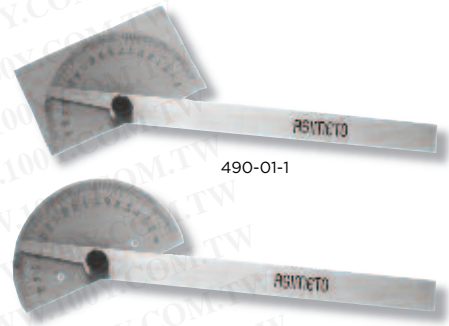

490-01-1

Universal Bevel Protractors 490 Series

FEATURES

- Dial Graduation: 1°, Vernier: 5'
- Designed to provide precise angular measurements
- Magnifying glass is provided for easier reading
- Can be used with a standard height gauge to provide angular measurement from reference plate
- Accuracy: ±5 min

STANDARD ACCESSORIES

- Base, Blades, Bevel Blades, Warranty card, Instruction manual

SPECIFICATIONS

Description	Code No.
With 150mm/6" blades	490-06-1
With 200mm/8" blades	490-06-2
With 300mm/12" blades	490-06-3
With three blades: 150mm/6", 200mm/8", 300mm/12"	490-06-0



490-06-1

Universal Angle Protractor 490 Series

FEATURES

- Graduation: 2'
- With fine adjustment device
- measuring surface
- The combination of flexible measuring way
- Accuracy: ±2 min

STANDARD ACCESSORIES

- Base, Blades, Bevel Blades, Warranty card, Instruction manual

SPECIFICATIONS

Description	Code No.
With 90° Square, Ruler	490-05-0

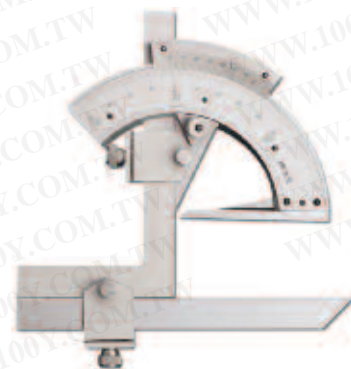

490-05-0

Dial Protractor 490 Series

FEATURES

- Measuring Range: 0-360°, Graduation: 5'
- Designed with analog readout and fine adjustment to provide precise angular measurements
- Can be used with a standard height gauge to provide angular measurement from reference plate
- Accuracy: ± 5 min

STANDARD ACCESSORIES

- Base, Blades (3 pcs), Bevel Blade
- Warranty card, Instruction manual

SPECIFICATIONS

Blades Included	Code No.
150mm/6", 200mm/8", 300mm/12"	490-10-0

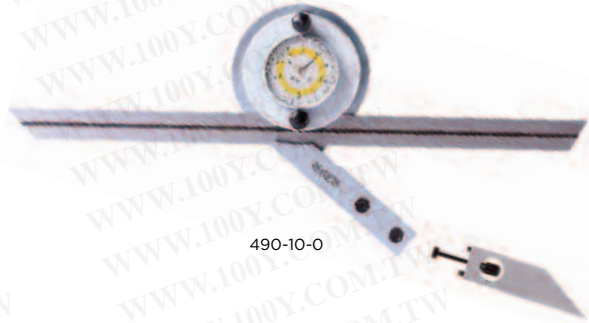

490-10-0

Digital Protractor 490 Series

FEATURES

- Resolution: 30"/0.008"
- Measuring Range: 0-360°
- Range selection: 1 x 360°, 2 x 180°, 4 x 90°
- Dual reading LCD display arc minutes / decimal degrees
- With fine adjustment
- Preset function
- Accuracy: ± 5 min

STANDARD ACCESSORIES

- Base, Blades (3 pcs), Bevel Blade, Setting Square
- Warranty card, Instruction manual

SPECIFICATIONS

Blades Included	Code No.
150mm/6", 200mm/8", 300mm/12"	490-15-0



490-15-0

LCD Display Screen

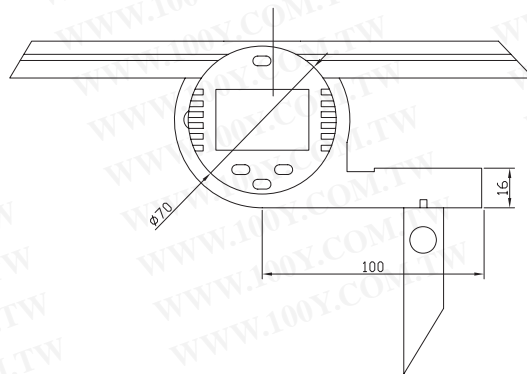

Depth and Angle Gauges

607 Series

FEATURES

- Hardened steel head with 2-1/2" base.
- Angles: 30°, 45°, 60° both sides.
- Stainless steel blade: 6" x 7/32" with 32nds and 64ths graduations.
- Rod: Non-graduated, for holes under 3/32" diameter.

SPECIFICATIONS

Range	Code No.
Head With Blade	607-58-0
Head With Blade and Rod	607-58-1



Combination Square Sets

490 Series

FEATURES

- Graduation:
 - Protractor: 1°
 - Blade: 1mm, 64ths, 32nds, 1/2mm
- Blades are hardened and tempered for durability
- Square head has level and pointed attachment for hand scribing
- Micro-fine blade graduations
- Gauge heads are hardened cast finished in baked enamel with exception of the measurement faces

SPECIFICATIONS

Description	Blade Length	Code No.
4 pcs Set	12"/300mm	490-20-4
3 pcs Set (Blades, Squares, 45° Center Gauges)	12"/300mm	490-20-3
3 pcs Set (Blades, Squares, 45° Center Gauges)	6"/150mm	490-20-6
2 pcs Set (Blades, Squares)	12"/300mm	490-20-2
2 pcs Set (Blades, Dial Scale)	12"/300mm	490-20-5
4 pcs Set (With 4R ruler)	12"/300mm	490-21-4
4 pcs Set (With 16R ruler)	12"/300mm	490-22-4

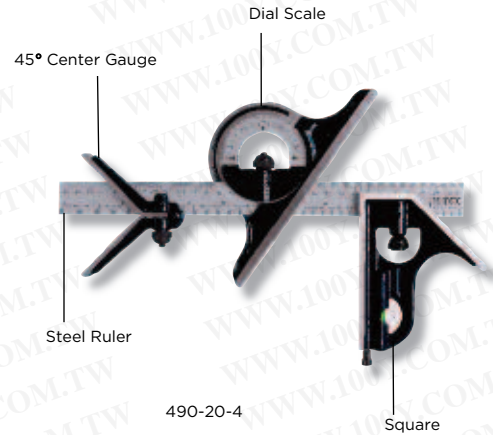

Steel Squares

639 Series

FEATURES

- Made of precision ground hardened stainless steel
- Accuracy according to DIN875

SPECIFICATIONS

Inch Size	Metric Size	Regular Type		Bevel Type	
		Squareness	Code No.	Squareness	Code No.
General Type Squares					
2" x 1.6"	50 x 40mm	0	639-21-4	00	639-21-0
3" x 2"	75 x 50mm	0	639-22-4	00	639-22-0
4" x 2.75"	100 x 70mm	0	639-23-4	00	639-23-0
6" x 4"	150 x 100mm	0	639-24-4	00	639-24-0
8" x 5"	200 x 130mm	0	639-25-4	00	639-25-0
10" x 6.5"	250 x 160mm	0	639-26-4	00	639-26-0
12" x 8"	300 x 200mm	0	639-27-4	00	639-27-0
16" x 10"	400 x 265mm	1	639-28-4	-	-
20" x 12"	500 x 330mm	1	639-29-4	-	-
Squares with Wider Base, "Engineers Square"					
2" x 1.6"	50 x 40mm	0	639-31-4	00	639-31-0
3" x 2"	75 x 50mm	0	639-32-4	00	639-32-0
4" x 2.75"	100 x 70mm	0	639-33-4	00	639-33-0
6" x 4"	150 x 100mm	0	639-34-4	00	639-34-0
8" x 5"	200 x 130mm	0	639-35-4	00	639-35-0
10" x 6.5"	250 x 165mm	0	639-36-4	00	639-36-0
12" x 8"	300 x 200mm	0	639-37-4	00	639-37-0
Squares with Extra Base Regular Type					
3" x 2"	75 x 50mm	0	639-53-0	1	639-53-1
4" x 2.75"	100 x 70mm	0	639-54-0	1	639-54-1
6" x 4"	150 x 100mm	0	639-55-0	1	639-55-1
8" x 5"	200 x 130mm	0	639-56-0	1	639-56-1
10" x 6.5"	250 x 160mm	0	639-57-0	1	639-57-1
12" x 8"	300 x 200mm	0	639-58-0	1	639-58-1
16" x 10"	400 x 265mm	1	639-59-0	-	-
20" x 12"	500 x 330mm	1	639-60-0	-	-

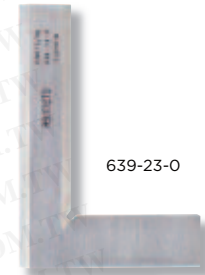

639-23-0



639-24-4



639-33-4

Granite Squares

639 Series

FEATURES

- Made of wear resistant black granite
- The flatness of the datum surfaces is according to DIN876/00
- Squareness is according to DIN875

SPECIFICATIONS

Just Size	Thickness	Accuracy	Code No.
200 x 150mm	50mm	00	639-01-0
300 x 200mm	50mm	00	639-02-0
400 x 250mm	50mm	00	639-03-0
500 x 300mm	60mm	00	639-04-0
600 x 400mm	70mm	00	639-05-0
800 x 500mm	80mm	00	639-06-0
1000 x 600mm	100mm	00	639-07-0



639-03-0

Just Size	Thickness	Accuracy	Code No.
400 x 400mm	40mm	00	639-01-1

Straight Knife Edges

639 Series

FEATURES

- Made of hardened stainless steel
- The design incorporates a precise 45 degree cross section allowing for visual inspection of surfaces
- The back edge is fitted with a thermal plastic grip to reduce the effects of heat transfer
- Straightness according to DIN874/00

SPECIFICATIONS

Inch Size	Metric Size	Squareness	Code No.
3"	75mm	00	639-71-0
4"	100mm	00	639-72-0
5"	125mm	00	639-73-0
6"	150mm	00	639-74-0
8"	200mm	00	639-75-0
12"	300mm	00	639-76-0
16"	400mm	00	639-77-0
20"	500mm	00	639-78-0
24"	600mm	00	639-79-0



639-73-0

5-pcs Square Set

639 Series

- Packaging: Wooden case

Code No.	639-00-8
Description	Qty.
Straight edge 100 mm	1
Precision square 75 x 50 mm	1
Precision square 40 x 28 mm	1
Precision square 25 x 20 mm	1
Scriber 9 x 9 x 60 mm	1



639-00-8

Die Makers Square Set

606 Series

FEATURES

- Use for precise miniature layouts.
- Hardened and ground with very fine finish extremely accurate.
- Set includes: 3 hardened beveled edge squares; 3/4", 1-1/4", 2-3/8" plus 1-1/2" triangular straight edge with handle complete in a fitted case.
- Straight edge sides are machined in the middle for clearance of burs and dirt.

Specifications of Squares: Beam	Blade
1-15/16"	2-15/16"
1-1/8"	1-9/16"
3/4"	1"

SPECIFICATIONS

Description	Included	Code No.
Diemaker's Square Set	3 hardened beveled edge squares 1PCS, Squares 3PCS	606-67-0



4-Way V-Blocks

607 Series

FEATURES

- Manufactured from close grained cast iron.
- Precisely machined and ground square and parallel within .0008".
- V-groove parallel to bearing surface within .0008".
- Each V-Block has 4 different size V's, supporting a large range of diameters.
- Furnished in matched and numbered pairs.
- V angle: 90° (with 1/8" groove at bottom of V).



SPECIFICATIONS

Length	Height	Width	V Openings	Code No.
3-3/4"	2-3/4"	1-3/8"	13/16", 1-1/4", 1-1/16", 2"	607-04-0
4"	4"	1-5/32"	7/8", 1-1/4", 1-5/8", 2"	607-05-0
4-3/4"	4-3/4"	1-3/8"	1-1/4", 1-5/8", 2-1/8", 2-1/2"	607-06-0

Cast Vee Blocks

607 Series

FEATURES

- Precision ground matched pairs made of Cast Iron Grade 20.
- Supports objects that are cylindrical and 90° or less.
- Accuracy:
Flatness: .0005"
Parallelism: .0008"
Perpendicularity: .0008"



SPECIFICATIONS

Width	V-Opening	Height	Length	V-Cap.	Code No.
2"	7/8"	1-1/4"	15/16"	1-5/32"	607-70-0
3"	1-3/4"	2-3/8"	1-5/16"	2-7/16"	607-71-0
4"	2-3/16"	2-9/16"	1-9/16"	3-1/16"	607-72-0
5"	2-7/16"	3-1/16"	1-15/16"	3-3/8"	607-73-0
6"	3-1/16"	3-1/2"	2-6/17"	4-1/4"	607-74-0
7-7/8"	4-6/17"	5-1/2"	3-15/16"	6-1/4"	607-75-0
9-7/8"	4-15/16"	6-1/2"	4-15/16"	6-15/16"	607-76-0
11-13/16"	5-1/16"	7-7/8"	5-15/16"	7-1/16"	607-77-0

1-2-3, 2-3-4 & 2-4-6 Blocks

607 Series

FEATURES

- Height accuracy in Pair: +/- .0001"
- Hardened steel to HRC 55-60, ground to surface finish 6-16 microinches
- Squareness: 0.0002"
- Parallelism: .0001"

SPECIFICATIONS

	Description	Code No.
1-2-3 Block	5 tapped holes (3/8"-16), 18 untapped holes (0.340" dia.)	607-01-0
2-3-4 Block	5 tapped holes (3/8"-16), 18 untapped holes (0.340" dia.)	607-01-1
2-4-6 Block	5 tapped holes (5/8"-11), 18 untapped holes (0.520" dia.)	607-01-2



Magnetic V-Blocks

609 Series

FEATURES

- workpiece can be placed on v-shape or top surface
- The rotary knob switches natural magnet on or off
- The precision surfaces and the bottom V are securely fastened to the ferrous work piece or machine table when the rotary knob is in the on position

609-13-0

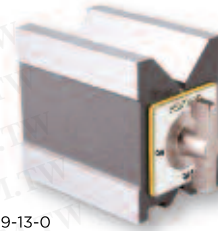

SPECIFICATIONS

Magnetic Power	Magnetic Base (L X W X H)	A	Weight	Code No.
60 kgf	70x60x72mm	36mm	1.6kg	609-10-0
70 kgf	80x56x72mm	36mm	1.7kg	609-11-0
80 kgf	125x60x72mm	36mm	3.0kg	609-12-0
70 kgf	100x70x95mm	46mm	4.0kg	609-13-0
80 kgf	115x75x100mm	50mm	5.2kg	609-14-0

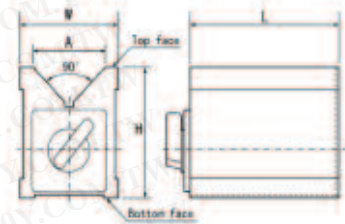

V-Blocks with Clamp

606 Series

FEATURES

- Made with hardened steel at HRC55-62
- With spring clamping bar.
- Delivered in pairs
- Accuracy: Parallelism & Squareness: 0.005mm



606-60-0



606-60-6

SPECIFICATIONS

Dimension	For Shaft Dia.	Code No.
Plain Clamp		
30x35x35mm	25mm	606-60-0
60x60x50mm	55mm	606-61-0
105x105x78mm	100mm	606-62-0
Deep Throat Clamp		
40x35x35mm	25mm	606-60-6
70x45x41mm	40mm	606-60-2
70x63x44mm	40mm	606-60-4

Magnetic Base Protractor

607 Series

FEATURES

- Machined V-Base and leg ends have strong magnetic pull making it easy to secure to the work piece.
- Used for tool rooms and machine shops to find center of round stock and to make angular adjustments.
- 2-3/8" dial face has machine-divided graduations to 1 degree in four 90° quadrants.
- Maximum V-Opening: 3-3/16".
- Overall length of legs: 4-13/16"
- Accuracy: ±3 minutes.

SPECIFICATIONS

Code No.
607-27-0



Round Bar Center Finder

607 Series



FEATURES

- Accurately and quickly locates the center of round work pieces.
- Shank is held in collet or chuck and center is easily indicated by visual alignment of etched lines.
- Satin chrome finish.
- 3" capacity.

SPECIFICATIONS

Code No.
607-28-0

Wiggler Sets

607 Series



FEATURES

- Versatile Center & Edge Finder with 4 interchangeable attachments which snap conveniently into the special chuck.
- Ball swivel joint permits adjustments to an angular position or true concentricity.
- Set includes offset indicator holder, ball contact attachment- 0.250" dia., disc contact attachment- 0.100" dia. and needle point attachment.

Code No. : 607-29-0		
Replacement Attachments	Description	Code No.
Chuck		607-29-1
Needle Point	Length: Closed 2-3/8", Open: 4-1/8"	607-29-2
Ball Contact	Shank Dia.: 3/8", Ball Dia.: .250"	607-29-3
Disc Contact	.100" Dia.	607-29-4
Offset Indicator Holder		607-29-5

CNC Tool Setting Gauges

607 Series

FEATURES

- Designed for use on CNC slant bed machines.
- Accurately sets turning, boring and facing tools on the centerline of the workpiece.
- Adjustable to any slant angle (360°).
- 607-03-0 includes easy-to-read laser etched protractor.

SPECIFICATIONS

Description	Code No.
Tool Setting Gauge	607-02-0
Deluxe Tool Setting Gauge	607-03-0



Angle Gauges

605 Series

FEATURES

- Material: Satin finished stainless steel
- Each gauge has eight precision radii
- The contour of each gauge has: 50% of primary angle and complementary angles including internal and external angles
- Various purposes including alignment of the lathe tool bit and for checking cutting tool geometry

SPECIFICATIONS

Description	No. of Leaves	Code No.
Angle gauges set	18	605-01-0



Individual Gauges Included

Primary Angle	1/2 Primary Angle	Accuracy	Complementary Angle	Primary Angle	1/2 Primary Angle	Accuracy	Complementary Angle
5° D	2°30'	±5'	175° D	50° D	25° D	±5'	130° D
10° D	5° D	±5'	170° D	55° D	27°30'	±5'	125° D
15° D	7°30'	±5'	165° D	60° D	30° D	±5'	120° D
20° D	10° D	±5'	160° D	65° D	32°30'	±5'	115° D
25° D	12°30'	±5'	155° D	70° D	35° D	±5'	110° D
30° D	15° D	±5'	150° D	75° D	37°30'	±5'	105° D
35° D	17°30'	±5'	145° D	80° D	40° D	±5'	100° D
40° D	20° D	±5'	140° D	85° D	42°30'	±5'	95° D
45° D	22°30'	±5'	135° D	90° D	45° D	±5'	90° D

FEATURES

- Made of hardened steel. Hardness HRC 55
- Accuracy according to DIN / ISO 3650

SPECIFICATIONS

10 pcs Set

Length x Thickness	Angle	Accuracy	Code No.
3" x 1/4"	1°- 5° by step of 1° 10°- 30° by step of 5°	±0.01°	605-06-0



605-06-0

2 pcs Set

Size	Thickness	Angle	Accuracy	Code No.
3x3x4-3/8"	1/4"	45°x 45°x 90°	±0.01°	605-06-2
2x3-15/16x4"	1/4"	30°x 60°x 90°		

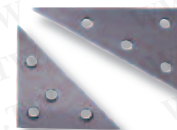

605-06-2

7 pcs Set

Grade	Individual Blocks Included	Code No.
DIN/1	15°10', 30°20', 45°30' 50°, 60°40', 75°50', 90°	605-06-3



605-06-3



Thread Pitch Gauges

605 Series

FEATURES

- Each individual gauge is stamped with the thread pitch size
- See chart below for different thread forms

SPECIFICATIONS

Metric Screw Pitch Gauges (60°)

Range	No. of Leaves	Composition of Leaves	Code No.
0.25 - 2.5mm	28	0.25 - 0.90mm by 0.05mm , 1 - 2mm x 0.1mm step , Plus 1.25, 1.75, 2.5mm	605-50-0
0.35 - 6mm	22	0.35, 0.4, 0.45, 0.5, 0.6, 0.7, 0.75, 0.8, 1, 1.25, 1.5, 1.75, 2, 2.5, 3, 3.5, 4, 4.5, 5, 5.5, 6mm, and 60° angle gauge	605-51-0
0.4 - 7mm	21	0.4, 0.5, 0.7, 0.75, 0.8, 0.9, 1, 1.25, 1.5, 1.75, 2, 2.5, 3, 3.5, 4, 4.5, 5, 5.5, 6, 6.5, 7mm	605-52-0
0.4 - 7mm	18	0.4, 0.5, 0.75, 1, 1.25, 1.5, 1.75, 2, 2.5, 3, 3.5, 4, 4.5, 5, 5.5, 6, 6.5, 7mm	605-53-0

Unified Screw Pitch Gauges (60°)

Range	No. of Leaves	Composition of Leaves	Code No.
4 - 42 TPI	30	4, 4-1/2, 5, 5-1/2, 6, 7, 8, 9, 10, 11, 11-1/2, 12, 13, 14, 15, 16, 18, 20, 22, 24, 26, 27, 28, 30, 32, 34, 36, 38, 40, 42 TPI	605-50-2
4 - 84 TPI	51	4, 4-1/2, 5, 5-1/2, 6, 7, 8, 9, 10, 11, 11-1/2, 12, 13, 14, 15, 16, 18, 20, 22, 24, 26, 27, 28, 30 - 84 by 2 , TPI	605-51-2

Metric and Unified Screw Pitch Gauges (60°)

Range	No. of Leaves	Composition of Leaves	Code No.
0.4 - 7mm 4 - 42 TPI	51	605-52-0 and 605-50-2	605-50-8
0.5 - 6mm 4 - 56 TPI	28	0.5, 1, 1.25, 1.5, 1.75, 2, 2.5, 3, 3.5, 4, 4.5, 5, 5.5, 6mm 4, 6, 7, 8, 10, 11, 11-1/2, 12, 13, 16, 20, 28, 32 TPI	605-51-8

Whitworth Screw Pitch Gauges (55°)

Range	No. of Leaves	Composition of Leaves	Code No.
4 - 42 TPI	30	4, 4-1/2, 5, 5-1/2, 6, 7, 8, 9, 10, 11, 11-1/2, 12, 13, 14, 15, 16, 18, 20, 22, 24, 26, 27, 28, 30, 32, 34, 36, 38, 40, 42 TPI	605-50-5
4 - 60 TPI	28	4, 4-1/2, 5, 6, 7, 8, 9, 10, 11, 12, 13, 14, 16, 18, 20, 22, 24, 25, 26, 28, 30, 32, 34, 36, 40, 48, 60 TPI	605-51-5



Center Gauge

605 Series

FEATURES

- Precision machined hardened steel
- Profile is for 60 degree threads
- Scales markings:
Side 1 with 14ths and 20ths graduations
Side 2 with 24ths and 32ths graduations



Code No. 605-60-0

Radius Gauges

605 Series

FEATURES

- Size is permanently marked on each gauge leaf
- Gauge profiles have both convex and concave radii



605-42-0

SPECIFICATIONS

Range	Qty.	Composition of Leaves	Remark	Code No.
1/32" - 17/64"	16 Slise	1/32" -17/64" x 1/64" step	90° arc.	605-40-1
1/32" - 1/4"	15 Slise	1/32" -1/4" x 1/64" step	180° arc.	605-41-1
17/64" - 1/2"	16 Slise	17/64" - 1/2" x 1/64" step	180° arc.	605-42-1
9/32" - 33/64"	16 Slise	9/32" - 33/64" x 1/64" step	90° arc.	605-43-1
1/64" - 1/2"	25 Slise	1/64" - 17/64" x 1/64" step, 9/32" - 1/2" x 1/32" step	-	605-44-1
0.5 - 13mm	26 Slise	0.5 - 13mm x 0.5mm step	90° arc.	605-41-0
1 - 7mm	17 pairs	1-3mm x 0.25mm step, 3.5-7mm x 0.5mm step	180° arc.	605-42-0
7.5 - 15mm	16 pairs	7.5 - 15mm x 0.5mm step	180° arc.	605-43-0
15.5 - 25mm	15 pairs	15.5 - 20mm x 0.5mm step, 21-25mm x 1mm step	180° arc.	605-44-0

Spring Dividers and Calipers

606 Series

FEATURES

- Manufactured from hardened durable material
- Contact surfaces are rounded

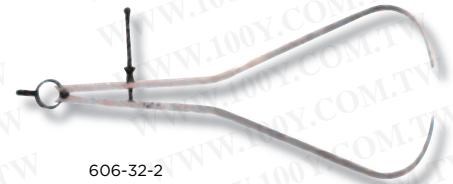

606-32-2

SPECIFICATIONS

Inch	Metric	Spring Divider	Outside Spring Caliper	Inside Spring Caliper
Range	Range	Code No.	Code No.	Code No.
6"	150mm	606-31-0	606-31-2	606-31-4
8"	200mm	606-32-0	606-32-2	606-32-4
10"	250mm	606-33-0	606-33-2	606-33-4
12"	300mm	606-34-0	606-34-2	606-34-4
16"	400mm	606-35-0	606-35-2	606-35-4
20"	500mm	606-36-0	606-36-2	606-36-4
24"	600mm	606-37-0	606-37-2	606-37-4



606-32-4



606-32-0

Digital Protractors - Level Type

490 Series

FEATURES

- This protractor provides an immediate digital reading of any angle in a full circle with 0°-90°-0°-90°-0° readings. The machined Aluminum frame is rigid and light with a precise platform that allows the sensor and its microprocessor circuit to provide high accuracy throughout the entire 360° range
- Four 90° quadrants for display purposes
- Calibrates in minutes without any special fixtures
- HOLD button for freezing a reading in an unreadable position
- ABS/ZERO button allows 2 measuring modes, Standard and Alternate Reference.
- V-grooves on top and bottom for use on curved surfaces
- Angle displayed upright regardless of protractor position
- Item #490-16-2 comes with magnet on base, which is helpful for fixing

STANDARD ACCESSORIES

- Battery, Warranty card, Instruction manual

SPECIFICATIONS

Code No.	490-16-0 / 490-16-2
Range	360°
Resolution	0.1°
Operating Temp. Range	23°F-122°F/-5°C-50°C
Power	3V, Lithium cell
Accuracy	±0.1°
Size	152x63.8x60mm
Weight	343g



490-16-0

Precision Levels

606 Series

FEATURES

- All measuring surfaces of the square models are precision ground to facilitate readings at both horizontal and vertical planes

SPECIFICATIONS

Range	Sensitivity	Code No.
Straight Models		
150 x 44mm	0.02mm/m	606-50-0
200 x 47mm	0.10mm/m	606-51-0
200 x 47mm	0.05mm/m	606-51-5
200 x 47mm	0.02mm/m	606-51-2
300 x 55mm	0.10mm/m	606-52-0
300 x 55mm	0.05mm/m	606-52-5
300 x 55mm	0.02mm/m	606-52-2
Square Models		
200 x 200 x 40mm	0.10mm/m	606-53-0
200 x 200 x 40mm	0.05mm/m	606-53-5
200 x 200 x 40mm	0.02mm/m	606-53-2
300 x 300 x 46mm	0.10mm/m	606-54-0
300 x 300 x 46mm	0.05mm/m	606-54-5
300 x 300 x 46mm	0.02mm/m	606-54-2



606-53-0

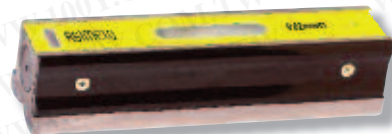

606-51-0

High Precision Metric Parallels

663 Series



663-02-0

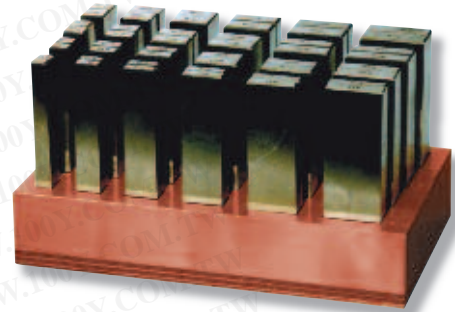

663-12-0

FEATURES

- Made of hardened steel. Hardness HRC 48
- Tolerance of Height: $\pm 0.01\text{mm}$
- Tolerance in pairs IT5

SPECIFICATIONS

Height of Individual Blocks	Length	Width	Number of Pairs	Code No.
14, 16, 18, 20, 22, 24, 26, 28, 30, 32, 35, 40mm	120mm	10mm	12	663-01-0
14, 16, 18, 20, 22, 24, 26, 28, 30, 32, 35, 40, 45, 50mm	150mm	10mm	14	663-02-0

Width x Height of Individual Blocks	Length	Number of Pairs	Code No.
2x5, 3x6, 4x7, 5x8, 6x9mm, 2x10, 3x11, 4x12, 5x13, 6x14mm, 2x15, 3x16, 4x17, 5x18, 6x19mm, 2x20, 3x21, 4x22, 5x23, 6x24mm	100mm	20	663-11-0
8x11, 10x13, 12x15, 14x17mm, 8x16, 10x18, 12x20, 14x22mm, 8x21, 10x23, 12x25, 14x27mm	125mm	24	663-12-0
8x26, 10x28, 12x30, 14x32mm, 8x31, 10x33, 12x35, 14x37mm, 8x36, 10x38, 12x40, 14x42mm	150mm	24	663-13-0

Precision Parallel Sets

607 Series

FEATURES

- hardened and ground high grade alloy steel.
- Hardness 52-58 HRC.
- 6" length.
- Height specifications consistent within each pair.
- Absolute heights are nominal.
- Supplied in durable molded plastic case.



SPECIFICATIONS

	Description	Thickness	Parallelism	Paired Accuracy	Width Accuracy	Length accuracy	Code No.
8 Pair Parallel Set	7/8" to 1-3/4" in 1/8" increments.	1/2"	$\pm 0.0003"$	$\pm 0.0003"$	$\pm 0.0008"$	$\pm 0.0006"$	607-08-0
9 Pair Parallel Set	3/4" to 1-3/4" in 1/8" increments.	1/4"	$\pm 0.0002"$	$\pm 0.0002"$	$\pm 0.0008"$	$\pm 0.0006"$	607-09-0
10 Pair Parallel Set	1/2" to 1-5/8" in 1/8" increments.	1/8"	$\pm 0.0002"$	$\pm 0.0002"$	$\pm 0.0008"$	$\pm 0.0006"$	607-10-0
10 Pair Parallel Set	1/2" to 1-5/8" in 1/8" increments.	1/32"	$\pm 0.0002"$	$\pm 0.0002"$	$\pm 0.0008"$	$\pm 0.0006"$	607-10-1



Granite Surface Plates

630 / 631 Series

FEATURES

- Material: Natural granite black in colour provides stability and longevity
- Each surface plate is shipped with a certificate of accuracy which guarantees its accuracy
- Granite surface plates are more common than cast iron plates due to the positive attributes
- Granite plate stands is not included



SPECIFICATIONS

Inch

Size	Grade AA
	Code No.
8x12x3"	631-10-9
9x12x3"	631-12-9
12x12x3"	631-14-9
12x18x4"	631-16-9
18x18x4"	631-18-9
18x24x4"	631-20-9
24x24x5"	631-22-9
24x30x5"	631-24-9
24x36x6"	631-26-9
24x48x8"	631-28-9
30x36x6"	631-30-9
30x48x8"	631-32-9
30x60x12"	631-34-9
36x36x6"	631-36-9
36x48x8"	631-38-9

Metric

Size	Grade 00
	Code No.
400x400x100mm	630-09-9
300x300x100mm	630-10-9
450x300x100mm	630-12-9
600x450x100mm	630-14-9
600x600x130mm	630-16-9
750x500x130mm	630-18-9
1000x750x150mm	630-20-9
1000x1000x150mm	630-22-9
1500x1000x200mm	630-24-9
2000x1000x250mm	630-26-9
2000x1500x300mm	630-28-9
2000x2000x300mm	630-30-9
3000x1500x400mm	630-32-9
3000x2000x500mm	630-34-9

Granite Plate Stands

638 Series

Size	Code No.
600x450x100mm	638-03-0
600x600x130mm	638-04-0
750x500x130mm	638-05-0
1000x750x150mm	638-06-0
1000x1000x150mm	638-07-0
1500x1000x200mm	638-08-0

Electronic Edge Finders

607 Series



607-15-0

FEATURES

- Repeatability: .002".
- Reads off any electrically conductive metal.
- Cylindrical style head.
- 1/2" shank.
- Furnished with LED indicator.

Code No.

607-15-0



607-16-0

FEATURES

- T.I.R. within .0002".
- Precision ground on all surfaces.
- Four highly visible LED lights.
- One-piece construction for strength and accuracy.
- Head diameter: 0.400"; 3/4" shank.

Code No.

607-16-0

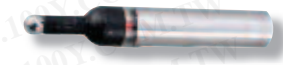

607-17-0

FEATURES

- Use on any electrically conductive material.
- Highly accurate - repeatability: .0002".
- Bright LED with six equally spaced light ports.

Code No.

607-17-0

Edge Finders

607 Series



607-30-0



607-40-0



607-41-0



607-32-0

FEATURES

- Hardened and ground all over.
- Accurately locates the starting point for all types of machine work and jig boring.

SPECIFICATIONS

Description	Shank Dia.	Tip Dia.	Code No.
Edge Finder (EF1)	3/8"	.200"	607-30-0
Edge Finder (EF2)	1/2"	.200"	607-31-0
Edge Finder (EF3)	1/2"	.500"	607-32-0
Edge Finder (EF4)	10mm / 3/8"	10mm	607-33-0
Edge Finder (EF5)	10mm	10mm	607-34-0
Center Finder (EF6)	3/8"		607-35-0
Center Finder (EF7)	1/2"		607-36-0
Combo Edge/Center Finder (EF8)	3/8"	.200"	607-37-0
Combo Edge/Center Finder (EF9)	1/2"	.200"	607-38-0
Sets			
4 Pcs Set	EF1, EF3, EF5, EF8		607-40-0
4 Pcs Set	EF2, EF6, EF7, EF9,		607-41-0



607-35-0



607-37-0



Automatic Weld Size Welding Gauge

607 Series

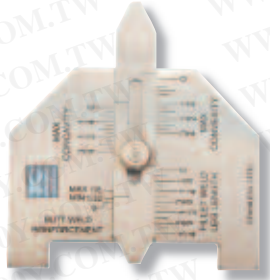

FEATURES

- For accurate inspection of butt and fillet type welds. Checks size of fillet welds, permissible tolerance of convexity, concavity, and reinforcement of butt welds.
- Stainless steel, pocket size construction.
- Inch readings
- Convexity and concavity sizes preset in accordance with AWS D1-1.

SPECIFICATIONS

Code No.
607-63-0

Bridge Cam Welding Gauge

606 Series



FEATURES

- This versatile cam-type weld gauge can be used for checking surfaces, angles, depths, etc.
- Can measure fit-up bevels, weld reinforcement, fillet weld leg length, undercuts and pits, throat of fillet weld, angles to 60° height of weld metal, and misalignments.
- High quality stainless steel construction.
- Quick and accurate measurement of most common weld sizes.
- Readings in Inch and Metric.
- Adjustable scale compensates for wear on pointer.

SPECIFICATIONS

Code No.
606-64-0

Universal Sliding Bevel

606 Series



FEATURES

- Straight slot allows for a wide variety of adjustments and angle settings not easily obtained with ordinary bevels
- Contains straight and offset slots on 6" adjustable blade.
- Duplicate any angle.
- Handle is 3-1/2" long with a straight slot.

SPECIFICATIONS

Code No.
606-65-0

American Standard & Wire Gauges

607 Series

FEATURES

- Made of heavy gauge hardened steel 62 RC.
- Satin chrome finish, no glare.
- Gaging slots meet Federal Specifications.
- Front face shows gauge size, back shows decimal equivalents adjacent to each slot.



SPECIFICATIONS

Description	Code No
American Standard and B&S Gauge for measuring wire diameter and non-ferrous sheets with copper, Aluminum and wrought iron.	607-60-0
U.S. Standard Gauge for measuring steel, plate iron and uncoated sheet metal.	607-61-0

Countersink Angle Gauge

607 Series

FEATURES

- Easily verifies countersink angles.
- Graduated in 32nds for depth measurement.
- Standard angles are 60, 82, 90, 100, 110 and 120°.



SPECIFICATIONS

Code No
607-62-0

Sine Bar Riser Kit

605 Series

FEATURES

Sine Bar:

- 5" length, 1" body size.
- Hardened and ground steel.
- Top parallel to bottom of rolls within .0002".

Riser:

- 18 risers: 1/2, 1, 2, 3, 4, 5, 6, 7, 8, 9, 10, 11, 12, 13, 14, 15, 1/4T and 1/2T.
- Within .0001" of exact constants.
- Note: Risers to be used individually, not to be stacked.
1/4T and 1/2T are to obtain angle of 1/4" and 1/2" taper per foot respectively.



SPECIFICATIONS

Description	Code No.
Sine Bar with Riser Kit	605-73-0

Gauges

- 149 Rectangular Gauge Block Sets
- 151 Rectangular Steel Gauge Block Sets
- 151 Rectangular Tungsten Steel Gauge Block Sets
- 152 Inch Individual Rectangular Gauge Blocks
- 153 Metric Individual Rectangular Gauge Blocks
- 154 Metric Individual Rectangular Ceramic Gauge Blocks
- 155 Caliper Calibration Gauge Sets
- 155 Micrometer Calibration Gauge Sets
- 156 Gauge Block Accessories
- 157 Check Masters
- 157 Optical Flats and Parallels
- 158 Plug Gauges and Ring Gauges
- 159 Thread Plug Gauges and Ring Gauges
- 161 ANSI Inch Thread Ring Gauges
- 162 Whitworth Pipe Thread Plug Gauges and Ring Gauges
- 162 NPT Thread Plug Gauges and Ring Gauges
- 162 Inch Master Setting Ring Gauges
- 163 ANSI Inch Thread Plug Gauges and Adjustable Ring Gauges
- 164 ANSI Metric Thread Plug Gauges and Ring Gauges
- 165 Individual Inspection Gauge Balls
- 165 Precision Inspection Gauge Ball Sets
- 166 36 pcs Round Space Block Set
- 166 Thread Measuring Wire Set
- 167 Pin Gauge Sets
- 169 Pin Gauge Handles

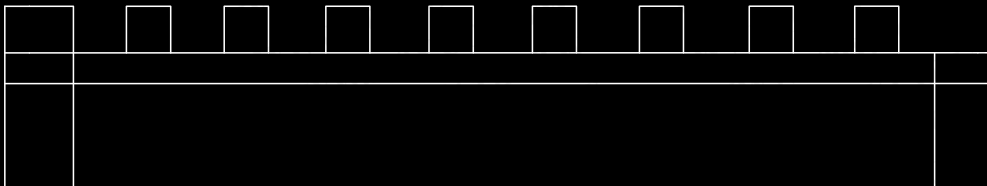

Rectangular Gauge Block Sets

650 Series

FEATURES

- Individual serial numbers on each block, regardless of grade
- A complete certificate of calibration traceable to the N.I.S.T or P.T.B showing the deviation of each block
- Mirror polished surfaces provide superior wringing characteristics



650-63-0

SPECIFICATIONS

Inch

Blocks Per Set	Blocks Included In Set	Grade	Former grade	Steel	Ceramic
				Code No.	Code No.
81 (ASME)	1 Block: .050" 10 Blocks: .1000"- .1009" x .0001" step 49 Blocks: .101"- .149" x .001" step 17 Blocks: .150"- .950" x .050" step 4 Blocks: 1.000"-4.000" x 1.000" step	0	2	650-01-0	650-51-0
		AS-1	3	650-01-1	650-51-1
		AS-2	B	650-01-2	-
36 (ASME)	1 Block: .050" 10 Blocks: .1000"- .1009" x .0001" step 9 Blocks: .101"- .109" x .001" step 9 Blocks: .110"- .190" x .010" step 4 Blocks: .200"- .500" x .100" step 3 Blocks: 1", 2", 4"	0	2	650-02-0	650-52-0
		AS-1	3	650-02-1	650-52-1
		AS-2	B	650-02-2	-

Metric

1 mm base set

Blocks Per Set	Blocks Included In Set	Grade	Steel	Ceramic
			Code No.	Code No.
122 (ASME / DIN /JIS / GB)	1 Blocks: 1.0005mm 9 Blocks: 1.001- 1.009mm x 0.001mm step 49 Blocks: 1.01- 1.49mm x 0.01mm step 4 Blocks: 1.6 - 1.9mm x 0.1mm step 49 Blocks: 0.5 - 24.5mm x 0.5mm step 8 Blocks: 30 - 100mm x 10mm step 2 Blocks: 25, 75mm	0	650-11-0	650-61-0
		1	650-11-1	650-61-1
		2	650-11-2	650-61-2
		0	650-11-0	650-61-0
112 (ASME / DIN /JIS / GB)	1 Blocks: 1.0005mm 9 Blocks: 1.001- 1.009mm x 0.001mm step 49 Blocks: 1.01- 1.49mm x 0.01mm step 49 Blocks: 0.5 - 24.5mm x 0.5mm step 4 Blocks: 25 - 100mm x 25mm step	0	650-17-0	650-67-0
		1	650-17-1	650-67-1
		2	650-17-2	650-67-2
103 (ASME / DIN /JIS / GB)	1 Blocks: 1.005mm 49 Blocks: 1.01- 1.49mm x 0.01mm step 49 Blocks: 0.5 - 24.5mm x 0.5mm step 4 Blocks: 25 - 100mm x 25mm step	0	650-12-0	650-62-0
		1	650-12-1	650-62-1
		2	650-12-2	650-62-2
88 (ASME / DIN /JIS / GB)	1 Blocks: 1.0005mm 9 Blocks: 1.001- 1.009mm x 0.001mm step 49 Blocks: 1.01- 1.49mm x 0.01mm step 19 Blocks: 0.5 - 9.5mm x 0.5mm step 10 Blocks: 10 - 100mm x 10mm step	0	650-18-0	650-68-0
		1	650-18-1	650-68-1
		2	650-18-2	650-68-2
87 (ASME / DIN /JIS / GB)	9 Blocks: 1.001- 1.009mm x 0.001mm step 49 Blocks: 1.01- 1.49mm x 0.01mm step 19 Blocks: 0.5 - 9.5mm x 0.5mm step 10 Blocks: 10 - 100mm x 10mm step	0	650-13-0	650-63-0
		1	650-13-1	650-63-1
		2	650-13-2	650-63-2
76 (ASME / DIN /JIS / GB)	1 Blocks: 1.005mm 49 Blocks: 1.01- 1.49mm x 0.01mm step 19 Blocks: 0.5 - 9.5mm x 0.5mm step 4 Blocks: 10 - 40mm x 10mm step 3 Blocks: 50 - 100mm x 25mm step	0	650-19-0	650-69-0
		1	650-19-1	650-69-1
		2	650-19-2	650-69-2

Rectangular Gauge Block Sets

650 Series

Metric 1 mm base set

Blocks Per Set	Blocks Included In Set	Grade	Steel	Ceramic
			Code No.	Code No.
56 (ASME / DIN / JIS / GB)	1 Block: 0.5mm 9 Block: 1.001- 1.009mm x 0.001mm step 9 Block: 1.01- 1.09mm x 0.01mm step 9 Block: 1.1- 1.9mm x 0.1mm step 24 Block: 1- 24mm x 1mm step 4 Block: 25 - 100mm x 25mm step	0	650-20-0	650-70-0
		1	650-20-1	650-70-1
		2	650-20-2	650-70-2
47 (ASME / DIN / GB)	1 Block: 1.005mm 20 Block: 1.01- 1.20mm x 0.01mm step 7 Block: 1.3 - 1.9mm x 0.1mm step 9 Block: 1- 9mm x 1mm step 10 Block: 10 - 100mm x 10mm step	0	650-14-0	650-64-0
		1	650-14-1	650-64-1
		2	650-14-2	650-64-2
47 (JIS)	1 Block: 1.005mm 9 Block: 1.01 - 1.09mm x 0.01mm step 9 Block: 1.1 - 1.9mm x 0.1mm step 24 Block: 1 - 24mm x 1mm step 4 Block: 25 - 100mm x 25mm step	0	650-15-0	650-65-0
		1	650-15-1	650-65-1
		2	650-15-2	650-65-2
46 (ASME / DIN / JIS / GB)	9 Block: 1.001- 1.009mm x 0.001mm step 9 Block: 1.01- 1.09mm x 0.01mm step 9 Block: 1.1 - 1.9mm x 0.1mm step 9 Block: 1- 9mm x 1mm step 10 Block: 10 - 100mm x 10mm step	0	650-21-0	650-71-0
		1	650-21-1	650-71-1
		2	650-21-2	650-71-2
34 (ASME / DIN / JIS / GB)	1 Block: 1.0005mm 9 Block: 1.001- 1.009mm x 0.001mm step 9 Block: 1.01 - 1.09mm x 0.01mm step 9 Block: 1.1- 1.9mm x 0.1mm step 6 Block: 1- 5 x 1mm step, 10mm	0	650-22-0	650-72-0
		1	650-22-1	650-72-1
		2	650-22-2	650-72-2
32 (ASME / DIN / JIS / GB)	1 Block: 1.005mm 9 Block: 1.01 - 1.09mm x 0.01mm step 9 Block: 1.1 - 1.9mm x 0.1mm step 9 Block: 1- 9mm x 1mm step 4 Block: 10mm, 20mm, 30mm, 50mm	0	650-16-0	650-66-0
		1	650-16-1	650-66-1
		2	650-16-2	650-66-2
24 (ASME / DIN / JIS / GB)	9 Block: 1.01 -1.09mm x 0.01mm step 9 Block: 1.1 - 1.9mm x 0.1mm step 5 Block: 1 - 5 mm x 1mm step 1 Block: 10 mm	0	650-23-0	650-73-0
		1	650-23-1	650-73-1
19 (ASME / DIN / JIS / GB)	9 Block: 1.1 - 1.9mm x 0.1mm step 5 Block: 1- 5 mm x 1mm step 2 Block: 10 - 20 mm x 10mm step 3 Block: 25mm, 50mm, 100 mm	0	650-24-0	650-74-0
		1	650-24-1	650-74-1
10 (ASME / DIN / JIS / GB)	5 Block: 1 - 5 mm x 1mm step 2 Block: 10 - 20 mm x 10mm step 3 Block: 25mm, 50mm, 100 mm	0	650-25-0	650-75-0
		1	650-25-1	650-75-1

Metric 0.001 mm base set

Blocks Per Set	Blocks Included In Set	Grade	Steel	Ceramic
			Code No.	Code No.
18 (ASME / DIN / JIS / GB)	9 Block: 0.991 - 0.999mm x 0.001mm step 9 Block: 1.001 - 1.009mm x 0.001mm step	0	650-26-0	650-76-0
		1	650-26-1	650-76-1
		2	650-26-2	650-76-2
9 (ASME / DIN / JIS / GB)	9 Block: 1.001 - 1.009mm x 0.001mm step	0	650-27-0	650-77-0
		1	650-27-1	650-77-1
		2	650-27-2	650-77-2
9 (ASME / DIN / JIS / GB)	9 Block: 0.991 - 0.999mm x 0.001mm step	0	650-28-0	650-78-0
		1	650-28-1	650-78-1
		2	650-28-2	650-78-2

Rectangular Steel Gauge Block Sets

650 Series

Metric 2 mm base Set

Blocks Per Set	Blocks Included In Set	Grade	ISO / DIN / JIS / GB	ASME
			Code No.	Code No.
112	1 Block: 2.0005mm 9 Block: 2.001- 2.009mm x 0.001mm step 49 Block: 2.01- 2.49mm x 0.01mm step 49 Block: 0.5 - 24.5mm x 0.5mm step 4 Block: 25 - 100mm x 25mm step	0	650-29-0	650-79-0
		1	650-29-1	650-79-1
		2	650-29-2	650-79-2
88	1 Block: 1.0005mm 9 Block: 2.001- 2.009mm x 0.001mm step 49 Block: 2.01- 2.49mm x 0.01mm step 19 Block: 0.5 - 9.5mm x 0.5mm step 10 Block: 10 - 100mm x 10mm step	0	650-30-0	650-80-0
		1	650-30-1	650-80-1
		2	650-30-2	650-80-2
88	1 Block: 2.0005mm 9 Block: 2.001- 2.009mm x 0.001mm step 49 Block: 2.01- 2.49mm x 0.01mm step 19 Block: 0.5 - 9.5mm x 0.5mm step 10 Block: 10 - 100mm x 10mm step	0	650-31-0	650-81-0
		1	650-31-1	650-81-1
		2	650-31-2	650-81-2
47	1 Block: 2.0005mm 9 Block: 2.001- 2.009mm x 0.001mm step 9 Block: 2.01- 2.09mm x 0.01mm step 9 Block: 2.1- 2.9mm x 0.1mm step 9 Block: 1- 9mm x 1mm step 10 Block: 10 - 100mm x 10mm step	0	650-32-0	650-82-0
		1	650-32-1	650-82-1
		2	650-32-2	650-82-2
46	9 Block: 2.001- 2.009mm x 0.001mm step 9 Block: 2.01- 2.09mm x 0.01mm step 9 Block: 2.1- 2.9mm x 0.1mm step 9 Block: 1- 9mm x 1mm step 10 Block: 10 - 100mm x 10mm step	0	650-33-0	650-83-0
		1	650-33-1	650-83-1
		2	650-33-2	650-83-2
33	1 Block: 2.005mm 9 Block: 2.01- 2.09mm x 0.01mm step 9 Block: 2.1- 2.9mm x 0.1mm step 9 Block: 1- 9mm x 1mm step 5 Block: 10mm, 20mm, 30mm, 60mm, 100mm	0	650-34-0	650-84-0
		1	650-34-1	650-84-1
		2	650-34-2	650-84-2
8	125mm, 150, 175, 200, 250, 300, 400, 500mm	0	650-35-0	650-85-0
		1	650-35-1	650-85-1
		2	650-35-2	650-85-2

Rectangular Tungsten Steel Gauge Block Sets

650 Series

Blocks Per Set	Blocks Included In Set	Grade	Code No.
87 (ASME / DIN / JIS / GB)	9 Block: 1.001- 1.009mm x 0.001mm step 49 Block: 1.01- 1.49mm x 0.01mm step 19 Block: 0.5 - 9.5mm x 0.5mm step 10 Block: 10 - 100mm x 10mm step	0	650-93-0
		1	650-93-1
103 (ASME / DIN / JIS / GB)	1 Block: 1.005mm 49 Block: 1.01- 1.49mm x 0.01mm step 49 Block: 0.5 - 24.5mm x 0.5mm step 4 Block: 25 - 100mm x 25mm step	0	650-92-0
		1	650-92-1
112 (ASME / DIN / JIS / GB)	1 Block: 1.0005mm 9 Block: 1.001- 1.009mm x 0.001mm step 49 Block: 1.01- 1.49mm x 0.01mm step 49 Block: 0.5 - 24.5mm x 0.5mm step 4 Block: 25 - 100mm x 25mm step	0	650-97-0
		1	650-97-1

Inch Individual Rectangular Gauge Blocks

65X Series

FEATURES

- ASME / DIN / JIS / GB Standard
- ASME Grade 0 is available for both Steel and Ceramic individuals,
- ASME Grade 1 is only available for Steel



651-87-0

SPECIFICATIONS

Size	Steel		Ceramic
	Grade 0	Grade 1	Grade 0
.05"	651-01-0	651-01-1	655-01-0
.05005"	651-02-0	651-02-1	655-02-0
.0503"	651-03-0	651-03-1	655-03-0
.0506"	651-04-0	651-04-1	655-04-0
.0507"	651-05-0	651-05-1	655-05-0
.0508"	651-06-0	651-06-1	655-06-0
.0509"	651-07-0	651-07-1	655-07-0
.052"	651-08-0	651-08-1	655-08-0
.053"	651-09-0	651-09-1	655-09-0
.054"	651-10-0	651-10-1	655-10-0
.055"	651-11-0	651-11-1	655-11-0
.056"	651-12-0	651-12-1	655-12-0
.058"	651-13-0	651-13-1	655-13-0
.06"	651-14-0	651-14-1	655-14-0
.1"	651-15-0	651-15-1	655-15-0
.10005"	651-16-0	651-16-1	655-16-0
.1001"	651-17-0	651-17-1	655-17-0
.1002"	651-18-0	651-18-1	655-18-0
.1003"	651-19-0	651-19-1	655-19-0
.1004"	651-20-0	651-20-1	655-20-0
.1005"	651-21-0	651-21-1	655-21-0
.1006"	651-22-0	651-22-1	655-22-0
.1007"	651-23-0	651-23-1	655-23-0
.1008"	651-24-0	651-24-1	655-24-0
.1009"	651-25-0	651-25-1	655-25-0
.101"	651-26-0	651-26-1	655-26-0
.102"	651-27-0	651-27-1	655-27-0
.103"	651-28-0	651-28-1	655-28-0
.104"	651-29-0	651-29-1	655-29-0
.105"	651-30-0	651-30-1	655-30-0
.106"	651-31-0	651-31-1	655-31-0
.107"	651-32-0	651-32-1	655-32-0
.108"	651-33-0	651-33-1	655-33-0
.109"	651-34-0	651-34-1	655-34-0
.11"	651-35-0	651-35-1	655-35-0
.111"	651-36-0	651-36-1	655-36-0

Size	Steel		Ceramic
	Grade 0	Grade 1	Grade 0
.112"	651-37-0	651-37-1	655-37-0
.113"	651-38-0	651-38-1	655-38-0
.114"	651-39-0	651-39-1	655-39-0
.115"	651-40-0	651-40-1	655-40-0
.116"	651-41-0	651-41-1	655-41-0
.117"	651-42-0	651-42-1	655-42-0
.118"	651-43-0	651-43-1	655-43-0
.119"	651-44-0	651-44-1	655-44-0
.12"	651-45-0	651-45-1	655-45-0
.121"	651-46-0	651-46-1	655-46-0
.122"	651-47-0	651-47-1	655-47-0
.123"	651-48-0	651-48-1	655-48-0
.124"	651-49-0	651-49-1	655-49-0
.125"	651-50-0	651-50-1	655-50-0
.126"	651-51-0	651-51-1	655-51-0
.127"	651-52-0	651-52-1	655-52-0
.128"	651-53-0	651-53-1	655-53-0
.129"	651-54-0	651-54-1	655-54-0
.13"	651-55-0	651-55-1	655-55-0
.131"	651-56-0	651-56-1	655-56-0
.132"	651-57-0	651-57-1	655-57-0
.133"	651-58-0	651-58-1	655-58-0
.134"	651-59-0	651-59-1	655-59-0
.135"	651-60-0	651-60-1	655-60-0
.136"	651-61-0	651-61-1	655-61-0
.137"	651-62-0	651-62-1	655-62-0
.138"	651-63-0	651-63-1	655-63-0
.139"	651-64-0	651-64-1	655-64-0
.14"	651-65-0	651-65-1	655-65-0
.141"	651-66-0	651-66-1	655-66-0
.142"	651-67-0	651-67-1	655-67-0
.143"	651-68-0	651-68-1	655-68-0
.144"	651-69-0	651-69-1	655-69-0
.145"	651-70-0	651-70-1	655-70-0
.146"	651-71-0	651-71-1	655-71-0
.147"	651-72-0	651-72-1	655-72-0

Size	Steel		Ceramic
	Grade 0	Grade 1	Grade 0
.148"	651-73-0	651-73-1	655-73-0
.149"	651-74-0	651-74-1	655-74-0
.15"	651-75-0	651-75-1	655-75-0
.16"	651-76-0	651-76-1	655-76-0
.17"	651-77-0	651-77-1	655-77-0
.18"	651-78-0	651-78-1	655-78-0
.19"	651-79-0	651-79-1	655-79-0
.2"	651-80-0	651-80-1	655-80-0
.21"	651-81-0	651-81-1	655-81-0
.25"	651-82-0	651-82-1	655-82-0
.3"	651-83-0	651-83-1	655-83-0
.35"	651-84-0	651-84-1	655-84-0
.4"	651-85-0	651-85-1	655-85-0
.45"	651-86-0	651-86-1	655-86-0
.5"	651-87-0	651-87-1	655-87-0
.55"	651-88-0	651-88-1	655-88-0
.6"	651-89-0	651-89-1	655-89-0
.65"	651-90-0	651-90-1	655-90-0
.7"	651-91-0	651-91-1	655-91-0
.75"	651-92-0	651-92-1	655-92-0
.8"	651-93-0	651-93-1	655-93-0
.85"	651-94-0	651-94-1	655-94-0
.9"	651-95-0	651-95-1	655-95-0
.95"	651-96-0	651-96-1	655-96-0
1"	651-97-0	651-97-1	655-97-0
2"	651-98-0	651-98-1	655-98-0
3"	651-99-0	651-99-1	655-99-0
4"	652-00-0	652-00-1	656-00-0
5"	652-01-0	652-01-1	656-01-0
6"	652-02-0	652-02-1	-
7"	652-03-0	652-03-1	-
8"	652-04-0	652-04-1	-
10"	652-05-0	652-05-1	-
12"	652-06-0	652-06-1	-
16"	652-07-0	652-07-1	-
20"	652-08-0	652-08-1	-

Metric Individual Rectangular Gauge Blocks

653 / 654 Series

FEATURES

- ASME / DIN / JIS / GB Standard
- Steel Grade 0 and Grade 1

SPECIFICATIONS

	Grade 0	Grade 1
Size	Code No.	Code No.
0.5mm	653-01-0	653-01-1
1mm	653-02-0	653-02-1
1.001mm	653-03-0	653-03-1
1.002mm	653-04-0	653-04-1
1.003mm	653-05-0	653-05-1
1.004mm	653-06-0	653-06-1
1.005mm	653-07-0	653-07-1
1.006mm	653-08-0	653-08-1
1.007mm	653-09-0	653-09-1
1.008mm	653-10-0	653-10-1
1.009mm	653-11-0	653-11-1
1.01mm	653-12-0	653-12-1
1.02mm	653-13-0	653-13-1
1.03mm	653-14-0	653-14-1
1.04mm	653-15-0	653-15-1
1.05mm	653-16-0	653-16-1
1.06mm	653-17-0	653-17-1
1.07mm	653-18-0	653-18-1
1.08mm	653-19-0	653-19-1
1.09mm	653-20-0	653-20-1
1.1mm	653-21-0	653-21-1
1.11mm	653-22-0	653-22-1
1.12mm	653-23-0	653-23-1
1.13mm	653-24-0	653-24-1
1.14mm	653-25-0	653-25-1
1.15mm	653-26-0	653-26-1
1.16mm	653-27-0	653-27-1
1.17mm	653-28-0	653-28-1
1.18mm	653-29-0	653-29-1
1.19mm	653-30-0	653-30-1
1.2mm	653-31-0	653-31-1
1.21mm	653-32-0	653-32-1
1.22mm	653-33-0	653-33-1
1.23mm	653-34-0	653-34-1
1.24mm	653-35-0	653-35-1
1.25mm	653-36-0	653-36-1
1.26mm	653-37-0	653-37-1
1.27mm	653-38-0	653-38-1
1.28mm	653-39-0	653-39-1
1.29mm	653-40-0	653-40-1
1.3mm	653-41-0	653-41-1
1.31mm	653-42-0	653-42-1
1.32mm	653-43-0	653-43-1
1.33mm	653-44-0	653-44-1
1.34mm	653-45-0	653-45-1

	Grade 0	Grade 1
Size	Code No.	Code No.
1.35mm	653-46-0	653-46-1
1.36mm	653-47-0	653-47-1
1.37mm	653-48-0	653-48-1
1.38mm	653-49-0	653-49-1
1.39mm	653-50-0	653-50-1
1.4mm	653-51-0	653-51-1
1.41mm	653-52-0	653-52-1
1.42mm	653-53-0	653-53-1
1.43mm	653-54-0	653-54-1
1.44mm	653-55-0	653-55-1
1.45mm	653-56-0	653-56-1
1.46mm	653-57-0	653-57-1
1.47mm	653-58-0	653-58-1
1.48mm	653-59-0	653-59-1
1.49mm	653-60-0	653-60-1
1.5mm	653-61-0	653-61-1
1.6mm	653-62-0	653-62-1
1.7mm	653-63-0	653-63-1
1.8mm	653-64-0	653-64-1
1.9mm	653-65-0	653-65-1
2mm	653-66-0	653-66-1
2.5mm	653-67-0	653-67-1
3mm	653-68-0	653-68-1
3.5mm	653-69-0	653-69-1
4mm	653-70-0	653-70-1
4.5mm	653-71-0	653-71-1
5mm	653-72-0	653-72-1
5.5mm	653-73-0	653-73-1
6mm	653-74-0	653-74-1
6.5mm	653-75-0	653-75-1
7mm	653-76-0	653-76-1
7.5mm	653-77-0	653-77-1
8mm	653-78-0	653-78-1
8.5mm	653-79-0	653-79-1
9mm	653-80-0	653-80-1
9.5mm	653-81-0	653-81-1
10mm	653-82-0	653-82-1
10.5mm	653-83-0	653-83-1
11mm	653-84-0	653-84-1
11.5mm	653-85-0	653-85-1
12mm	653-86-0	653-86-1
12.5mm	653-87-0	653-87-1
13mm	653-88-0	653-88-1
13.5mm	653-89-0	653-89-1
14mm	653-90-0	653-90-1

	Grade 0	Grade 1
Size	Code No.	Code No.
14.5mm	653-91-0	653-91-1
15mm	653-92-0	653-92-1
15.5mm	653-93-0	653-93-1
16mm	653-94-0	653-94-1
16.5mm	653-95-0	653-95-1
17mm	653-96-0	653-96-1
17.5mm	653-97-0	653-97-1
18mm	653-98-0	653-98-1
18.5mm	653-99-0	653-99-1
19mm	654-00-0	654-00-1
19.5mm	654-01-0	654-01-1
20mm	654-02-0	654-02-1
20.5mm	654-03-0	654-03-1
21mm	654-04-0	654-04-1
21.5mm	654-05-0	654-05-1
22mm	654-06-0	654-06-1
22.5mm	654-07-0	654-07-1
23mm	654-08-0	654-08-1
23.5mm	654-09-0	654-09-1
24mm	654-10-0	654-10-1
24.5mm	654-11-0	654-11-1
25mm	654-12-0	654-12-1
30mm	654-13-0	654-13-1
40mm	654-14-0	654-14-1
50mm	654-15-0	654-15-1
60mm	654-16-0	654-16-1
70mm	654-17-0	654-17-1
75mm	654-18-0	654-18-1
80mm	654-19-0	654-19-1
90mm	654-20-0	654-20-1
100mm	654-21-0	654-21-1
125mm	-	654-22-1
150mm	-	654-23-1
175mm	-	654-24-1
200mm	-	654-25-1
250mm	-	654-27-1
300mm	-	654-29-1
400mm	-	654-31-1
500mm	-	654-33-1
600mm	-	654-35-1
700mm	-	654-37-1
800mm	-	654-39-1
900mm	-	654-41-1
1000mm	-	654-43-1

Metric Individual Rectangular Ceramic Gauge Blocks 657 / 658 Series

FEATURES

- ASME / DIN / JIS / GB Standard
- Ceramic Grade O

SPECIFICATIONS

Size	Code No.
0.5mm	657-01-0
1mm	657-02-0
1.001mm	657-03-0
1.002mm	657-04-0
1.003mm	657-05-0
1.004mm	657-06-0
1.005mm	657-07-0
1.006mm	657-08-0
1.007mm	657-09-0
1.008mm	657-10-0
1.009mm	657-11-0
1.01mm	657-12-0
1.02mm	657-13-0
1.03mm	657-14-0
1.04mm	657-15-0
1.05mm	657-16-0
1.06mm	657-17-0
1.07mm	657-18-0
1.08mm	657-19-0
1.09mm	657-20-0
1.1mm	657-21-0
1.11mm	657-22-0
1.12mm	657-23-0
1.13mm	657-24-0
1.14mm	657-25-0
1.15mm	657-26-0
1.16mm	657-27-0
1.17mm	657-28-0
1.18mm	657-29-0
1.19mm	657-30-0
1.2mm	657-31-0
1.21mm	657-32-0
1.22mm	657-33-0
1.23mm	657-34-0
1.24mm	657-35-0
1.25mm	657-36-0
1.26mm	657-37-0
1.27mm	657-38-0
1.28mm	657-39-0
1.29mm	657-40-0
1.3mm	657-41-0

Size	Code No.
1.31mm	657-42-0
1.32mm	657-43-0
1.33mm	657-44-0
1.34mm	657-45-0
1.35mm	657-46-0
1.36mm	657-47-0
1.37mm	657-48-0
1.38mm	657-49-0
1.39mm	657-50-0
1.4mm	657-51-0
1.41mm	657-52-0
1.42mm	657-53-0
1.43mm	657-54-0
1.44mm	657-55-0
1.45mm	657-56-0
1.46mm	657-57-0
1.47mm	657-58-0
1.48mm	657-59-0
1.49mm	657-60-0
1.5mm	657-61-0
1.6mm	657-62-0
1.7mm	657-63-0
1.8mm	657-64-0
1.9mm	657-65-0
2mm	657-66-0
2.5mm	657-67-0
3mm	657-68-0
3.5mm	657-69-0
4mm	657-70-0
4.5mm	657-71-0
5mm	657-72-0
5.5mm	657-73-0
6mm	657-74-0
6.5mm	657-75-0
7mm	657-76-0
7.5mm	657-77-0
8mm	657-78-0
8.5mm	657-79-0
9mm	657-80-0
9.5mm	657-81-0
10mm	657-82-0

Size	Code No.
10.5mm	657-83-0
11mm	657-84-0
11.5mm	657-85-0
12mm	657-86-0
12.5mm	657-87-0
13mm	657-88-0
13.5mm	657-89-0
14mm	657-90-0
14.5mm	657-91-0
15mm	657-92-0
15.5mm	657-93-0
16mm	657-94-0
16.5mm	657-95-0
17mm	657-96-0
17.5mm	657-97-0
18mm	657-98-0
18.5mm	657-99-0
19mm	658-00-0
19.5mm	658-01-0
20mm	658-02-0
20.5mm	658-03-0
21mm	658-04-0
21.5mm	658-05-0
22mm	658-06-0
22.5mm	658-07-0
23mm	658-08-0
23.5mm	658-09-0
24mm	658-10-0
24.5mm	658-11-0
25mm	658-12-0
30mm	658-13-0
40mm	658-14-0
50mm	658-15-0
60mm	658-16-0
70mm	658-17-0
75mm	658-18-0
80mm	658-19-0
90mm	658-20-0
100mm	658-21-0

Caliper Calibration Gauge Sets

659 Series

FEATURES

- DIN / GB Standard
- Material: Hardened Steel
- Grades 0 and 1 are available



659-31-1

SPECIFICATIONS

For DIN Standard

Individual Blocks in Set	Grade	Code No.	
30.0mm, 41.3mm, 131.4mm, Master Ring: Ø4.0mm, Ø25.0mm	0-150mm	1	659-31-1
41.3mm, 131.4mm, 243.5mm, Master Ring: Ø4.0mm, Ø25.0mm	0-300mm	0	659-32-0

For GB Standard

Individual Blocks in Set	Grade	Code No.	
10mm, 20mm, 20mm, 41.2mm, 81.5mm, 121.8mm	0-150mm	1	659-41-1
10mm, 20mm, 20mm, 51.2mm, 121.5mm, 191.8mm	0-200mm	1	659-42-1
10mm, 20mm, 20mm, 101.2mm, 201.5mm, 291.8mm	0-300mm	1	659-43-1

Micrometer Calibration Gauge Sets

659 Series

FEATURES

- DIN / GB Standard
- Steel or Ceramic, Grade 1



659-71-1

SPECIFICATIONS

For DIN Standard

Blocks in Set	Range	Grade	Steel Set	Ceramic Set
			Code No.	Code No.
5.1mm, 10.3mm, 15.0mm, 20.2mm, 25.0mm	0-25mm	1	659-21-1	659-71-1

For GB Standard

Blocks in Set	Range	Grade	Steel Set	Ceramic Set
			Code No.	Code No.
5.12mm, 10.24mm, 15.36mm, 21.5mm, 25.0mm	0-25mm	1	659-22-1	659-72-1
5.12mm, 10.24mm, 15.36mm, 21.5mm, 25.0mm, 30.12mm, 35.24mm, 40.36mm, 46.5mm, 50.0mm, 55.12mm, 60.24mm, 65.36mm, 71.5mm, 75.0mm, 80.12mm, 85.24mm, 90.36mm, 96.5mm, 100mm	0-100mm	1	659-23-1	659-73-1

Gauge Block Accessories

660 Series

FEATURES

- The gauge block accessory set is used to firmly connect rectangular gauge blocks with the gauge holding devices. A series of universal precision measuring surfaces and base are provided to increase the measurement flexibility

SPECIFICATIONS

Metric		12 pcs Set	17 pcs Set	
		660-01-0	660-01-1	
Description	Dimension	Individuals in Set	Individuals in Set	Code No.
Gauge Holder	0-50mm	1 pcs	1 pcs	660-10-1
	0-100mm	1 pcs	1 pcs	660-10-2
	100-200mm	1 pcs	1 pcs	660-10-3
Cylinder Jaws	R2 x 10mm	1 pair	1 pair	660-11-1
	R5 x 15mm	1 pair	1 pair	660-11-2
	R10 x 40mm	1 pair	1 pair	660-11-3
Scriber	15mm	1 pcs	1 pcs	660-12-3
Center Point	8 x 8mm	1 pcs	1 pcs	660-12-4
Parallel Jaw	8 x 19 x 100mm	-	1 pair	660-12-7
Base Block		1 pcs	1 pcs	660-05-0
Bevel Jaw	60mm	-	1 pair	660-06-2
Straight Edge	100mm	-	1 pcs	660-06-4

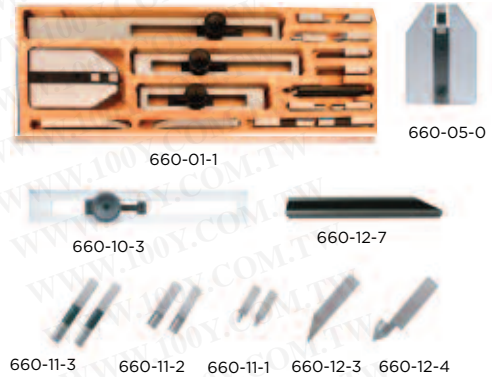

Inch				27 pcs Set	14 pcs Set	
				660-01-2	660-02-1	
#	Description/Use	Dimension	Accuracy	Individuals in Set	Individuals in Set	Code No.
A	Base Block	4 x 2-3/4 x 1.7"	Height: ± 0.0002 "	1 pcs	-	660-05-5
B	Scriber Point	1.950" Length	Flatness: ± 0.00002 "/2"	1 pcs	-	660-13-1
C	Center Point	2.05" Length	Concentricity: ± 0.0004 "	1 pcs	-	660-13-4
D	Points	2.05" Length	Concentricity: ± 0.0002 "	1 pair	-	660-13-5
E	Cylinder Jaws	Radius x A x B x C	Radius: ± 0.00003 "			
		.1"x.236"x1.58"x.315"	Pair: ± 0.00004 "	1 pair	1 pair	660-14-1
		.2"x.507"x1.965"x.315"		1 pair	1 pair	660-14-2
		.25"x.516"x2.366"x.315"		1 pair	1 pair	660-14-3
		.5"x.800"x2.945"x.512"		1 pair	1 pair	660-14-4
		.75"x1.2"x4.92"x.768"		1 pair	-	660-14-5
F	Flat Jaws	.750" Height, 6" Length	Parallelism: ± 0.00004 "	1 pair	-	660-13-7
G	Jaws with Ref. Line	.0625" Ref. line	Line Height: ± 0.0002 "	1 pair	-	660-14-6
H	Jaws with Beveled End	.750" Height, 4" Length	Flatness: ± 0.00002 "/2"	1 pair	1 pair	660-14-8
		.750" Height, 6" Length		1 pair	1 pair	660-14-9
I	Holders	2.250" Capacity, 4.175" Length	Working surfaces	1 pcs	1 pcs	660-15-1
		4.000" Capacity, 6.5" Length	accurately ground	1 pcs	-	660-15-2
		6.000" Capacity, 8.5" Length	and lapped	1 pcs	1 pcs	660-15-3
		10.000" Capacity, 12" Length		1 pcs	-	660-15-4

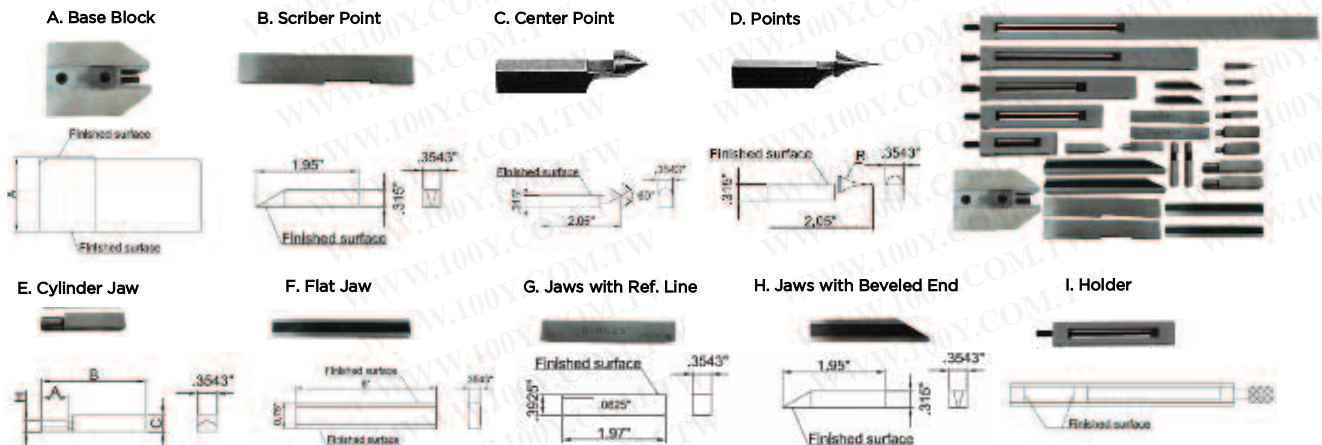

Check Masters

660 / 661 Series

FEATURES

- Check masters are used to provide the incremental positioning error during the calibration of Coordinate Measuring Machines or machine tools
- Can be used in either vertical or horizontal position
- The individual gauging surfaces are made of zirconium based ceramic that resist corrosion and provide stability to size change over time



660-12-0



661-12-0

SPECIFICATIONS

Range	Pitch	Accuracy	Parallelism	Horizontal	Vertical
				Code No.	Code No.
Inch					
12"	1"/.5"	±.00005"	.00004"	660-12-1	661-12-1
24"	1"/.5"	±.00007"	.00006"	660-24-1	661-24-1
Metric					
300mm	20mm/10mm	±1.2µm	1µm	660-12-0	661-12-0
600mm	20mm/10mm	±1.8µm	1.5µm	660-24-0	661-24-0

Customized pitch for special purpose is available also

Optical Flats and Parallels

605 Series

FEATURES

- Used to verify the flatness and parallelism of micrometer measuring faces
- Each set has four individual thicknesses as per chart
- Flatness: 0.1µm. Parallelism: 0.2µm

SPECIFICATIONS

Optical Flats

Dimensions	Flatness	Code No.
∅45 x 15mm	0.03µm	605-51-1
∅60 x 20mm	0.03µm	605-51-3



605-51-1

Optical Parallels Diameter: 30mm

Micrometers Range	Dimensions	Code No.
0-25mm	15.62, 15.75, 15.87, 16.00mm	605-52-1
25-50mm	40.62, 40.75, 40.87, 41.00mm	605-52-2
50-75mm	65.62, 65.75, 65.87, 66.00mm	605-52-3
75-100mm	90.62, 90.75, 90.87, 91.00mm	605-52-4



605-52-1

Plug Gauges and Ring Gauges

670 / 675 Series

FEATURES

- Hardened steel
- Plug Gauge Accuracy according to DIN 7162/7164
- Plug Gauge Sizes according to DIN 2245
- Ring Gauge Accuracy according to DIN 2250



670-10-7

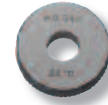

675-10-0

SPECIFICATIONS

Plug Gauges

Size	H7 Code No.	H6 Code No.	H8 Code No.	H9 Code No.
2mm	670-02-7	670-02-6	670-02-8	670-02-9
3mm	670-03-7	670-03-6	670-03-8	670-03-9
4mm	670-04-7	670-04-6	670-04-8	670-04-9
5mm	670-05-7	670-05-6	670-05-8	670-05-9
6mm	670-06-7	670-06-6	670-06-8	670-06-9
7mm	670-07-7	670-07-6	670-07-8	670-07-9
8mm	670-08-7	670-08-6	670-08-8	670-08-9
9mm	670-09-7	670-09-6	670-09-8	670-09-9
10mm	670-10-7	670-10-6	670-10-8	670-10-9
11mm	670-11-7	670-11-6	670-11-8	670-11-9
12mm	670-12-7	670-12-6	670-12-8	670-12-9
13mm	670-13-7	670-13-6	670-13-8	670-13-9
14mm	670-14-7	670-14-6	670-14-8	670-14-9
15mm	670-15-7	670-15-6	670-15-8	670-15-9
16mm	670-16-7	670-16-6	670-16-8	670-16-9
17mm	670-17-7	670-17-6	670-17-8	670-17-9
18mm	670-18-7	670-18-6	670-18-8	670-18-9
19mm	670-19-7	670-19-6	670-19-8	670-19-9
20mm	670-20-7	670-20-6	670-20-8	670-20-9
21mm	670-21-7	670-21-6	670-21-8	670-21-9
22mm	670-22-7	670-22-6	670-22-8	670-22-9
23mm	670-23-7	670-23-6	670-23-8	670-23-9
24mm	670-24-7	670-24-6	670-24-8	670-24-9
25mm	670-25-7	670-25-6	670-25-8	670-25-9
26mm	670-26-7	670-26-6	670-26-8	670-26-9
27mm	670-27-7	670-27-6	670-27-8	670-27-9
28mm	670-28-7	670-28-6	670-28-8	670-28-9
30mm	670-30-7	670-30-6	670-30-8	670-30-9
32mm	670-32-7	670-32-6	670-32-8	670-32-9

Size	H7 Code No.	H6 Code No.	H8 Code No.	H9 Code No.
34mm	670-34-7	670-34-6	670-34-8	670-34-9
35mm	670-35-7	670-35-6	670-35-8	670-35-9
36mm	670-36-7	670-36-6	670-36-8	670-36-9
37mm	670-37-7	670-37-6	670-37-8	670-37-9
38mm	670-38-7	670-38-6	670-38-8	670-38-9
40mm	670-40-7	670-40-6	670-40-8	670-40-9
42mm	670-42-7	670-42-6	670-42-8	670-42-9
44mm	670-44-7	670-44-6	670-44-8	670-44-9
45mm	670-45-7	670-45-6	670-45-8	670-45-9
46mm	670-46-7	670-46-6	670-46-8	670-46-9
47mm	670-47-7	670-47-6	670-47-8	670-47-9
48mm	670-48-7	670-48-6	670-48-8	670-48-9
50mm	670-50-7	670-50-6	670-50-8	670-50-9
52mm	670-52-7	670-52-6	670-52-8	670-52-9
55mm	670-55-7	670-55-6	670-55-8	670-55-9
60mm	670-60-7	670-60-6	670-60-8	670-60-9
62mm	670-62-7	670-62-6	670-62-8	670-62-9
65mm	670-65-7	670-65-6	670-65-8	670-65-9
68mm	670-68-7	670-68-6	670-68-8	670-68-9
70mm	670-70-7	670-70-6	670-70-8	670-70-9
72mm	670-72-7	670-72-6	670-72-8	670-72-9
75mm	670-75-7	670-75-6	670-75-8	670-75-9
80mm	670-80-7	670-80-6	670-80-8	670-80-9
85mm	670-85-7	670-85-6	670-85-8	670-85-9
90mm	670-90-7	670-90-6	670-90-8	670-90-9
95mm	670-95-7	670-95-6	670-95-8	670-95-9
98mm	670-98-7	670-98-6	670-98-8	670-98-9
100mm	671-00-7	671-00-6	671-00-8	671-00-9

Ring Gauge

Size	Code No.
2.0mm	675-02-0
2.2mm	675-02-2
2.5mm	675-02-5
2.8mm	675-02-8
3.0mm	675-03-0
3.5mm	675-03-5
4.0mm	675-04-0
4.5mm	675-04-5
5.0mm	675-05-0
6.0mm	675-06-0
7.0mm	675-07-0
8.0mm	675-08-0
9.0mm	675-09-0
10mm	675-10-0

Size	Code No.
11mm	675-11-0
12mm	675-12-0
13mm	675-13-0
14mm	675-14-0
15mm	675-15-0
16mm	675-16-0
17mm	675-17-0
18mm	675-18-0
19mm	675-19-0
20mm	675-20-0
21mm	675-21-0
22mm	675-22-0
23mm	675-23-0
24mm	675-24-0

Size	Code No.
25mm	675-25-0
26mm	675-26-0
27mm	675-27-0
28mm	675-28-0
30mm	675-30-0
32mm	675-32-0
33mm	675-33-0
34mm	675-34-0
35mm	675-35-0
36mm	675-36-0
37mm	675-37-0
38mm	675-38-0
40mm	675-40-0
42mm	675-42-0

Size	Code No.
44mm	675-44-0
45mm	675-45-0
46mm	675-46-0
47mm	675-47-0
48mm	675-48-0
50mm	675-50-0
52mm	675-52-0
55mm	675-55-0
58mm	675-58-0
60mm	675-60-0
62mm	675-62-0
65mm	675-65-0
68mm	675-68-0
70mm	675-70-0

Size	Code No.
72mm	675-72-0
75mm	675-75-0
80mm	675-80-0
82mm	675-82-0
85mm	675-85-0
88mm	675-88-0
90mm	675-90-0
92mm	675-92-0
95mm	675-95-0
98mm	675-98-0
100mm	676-00-0

Thread Plug Gauges and Ring Gauges

68X Series

FEATURES

- ISO-Metric Thread
- Per DIN 13



682-14-5



685-14-5



686-14-5

SPECIFICATIONS

	Plug Gauge 6H	Ring Gauge "GO" 6g	Ring Gauge "NO GO" 6g
Size	Code No.	Code No.	Code No.
ISO-Metric Coarse Thread			
M2	680-02-0	-	-
M2.5	680-02-5	-	-
M3	680-03-0	683-03-1	684-03-0
M3.5	680-03-5	683-03-6	684-03-5
M4	680-04-2	683-04-1	684-04-0
M5	680-05-2	683-05-1	684-05-0
M6	680-06-2	683-06-1	684-06-0
M8	680-08-2	683-08-1	684-08-0
M9	680-09-2	683-09-1	684-09-0
M10	680-10-2	683-10-1	684-10-0
M12	680-12-2	683-12-1	684-12-0
M14	680-14-2	683-14-1	684-14-0
M16	680-16-2	683-16-1	684-16-0
M18	680-18-2	683-18-1	684-18-0
ISO-Metric Fine Thread			
M2.0x0.35	682-02-0	685-02-0	686-02-0
M2.2x0.35	682-02-8	685-02-8	686-02-8
M2.5x0.35	682-02-9	685-02-9	686-02-9
M3.0x0.35	682-03-0	685-03-0	686-03-0
M3.5x0.35	682-03-9	685-03-9	686-03-9
M4.0x0.35	682-04-0	685-04-0	686-04-0
M4.5x0.35	682-04-9	685-04-9	686-04-9
M5.0x0.35	682-05-0	685-05-0	686-05-0
M6.0x0.35	682-06-0	685-06-0	686-06-0
M4.0x0.5	682-04-1	685-04-1	686-04-1
M5.0x0.5	682-05-1	685-05-1	686-05-1
M6.0x0.5	682-06-1	685-06-1	686-06-1
M8.0x0.5	682-08-1	685-08-1	686-08-1
M10x0.5	682-10-1	685-10-1	686-10-1
M12x0.5	682-12-1	685-12-1	686-12-1
M6.0x0.75	682-06-2	685-06-2	686-06-2
M7.0x0.75	682-07-2	685-07-2	686-07-2
M8.0x0.75	682-08-2	685-08-2	686-08-2
M10x0.75	682-10-2	685-10-2	686-10-2
M12x0.75	682-12-2	685-12-2	686-12-2
M8.0x1	682-08-3	685-08-3	686-08-3
M9.0x1	682-09-3	685-09-3	686-09-3
M10x1	682-10-3	685-10-3	686-10-3
M11x1	682-11-3	685-11-3	686-11-3
M12x1	682-12-3	685-12-3	686-12-3
M14x1	682-14-3	685-14-3	686-14-3
M16x1	682-16-3	685-16-3	686-16-3
M18x1	682-18-3	685-18-3	686-18-3

	Plug Gauge 6H	Ring Gauge "GO" 6g	Ring Gauge "NO GO" 6g
Size	Code No.	Code No.	Code No.
M20	680-20-2	683-20-1	684-20-0
M22	680-22-2	683-22-1	684-22-0
M24	680-24-2	683-24-1	684-24-0
M27	680-27-2	683-27-1	684-27-0
M30	680-30-2	683-30-1	684-30-0
M33	680-33-2	683-33-1	684-33-0
M36	680-36-2	683-36-1	684-36-0
M39	680-39-2	683-39-1	684-39-0
M42	680-42-2	683-42-1	684-42-0
M45	680-45-2	683-45-1	684-45-0
M48	680-48-2	683-48-1	684-48-0
M52	680-52-2	683-52-1	684-52-0
M56	680-56-2	683-56-1	684-56-0
M60	680-60-2	683-60-1	684-60-0
M20x1	682-20-3	685-20-3	686-20-3
M21x1	682-21-3	685-21-3	686-21-3
M22x1	682-22-3	685-22-3	686-22-3
M23x1	682-23-3	685-23-3	686-23-3
M24x1	682-24-3	685-24-3	686-24-3
M25x1	682-25-3	685-25-3	686-25-3
M26x1	682-26-3	685-26-3	686-26-3
M27x1	682-27-3	685-27-3	686-27-3
M28x1	682-28-3	685-28-3	686-28-3
M30x1	682-30-3	685-30-3	686-30-3
M32x1	682-32-3	685-32-3	686-32-3
M33x1	682-33-3	685-33-3	686-33-3
M34x1	682-34-3	685-34-3	686-34-3
M35x1	682-35-3	685-35-3	686-35-3
M36x1	682-36-3	685-36-3	686-36-3
M38x1	682-38-3	685-38-3	686-38-3
M39x1	682-39-3	685-39-3	686-39-3
M40x1	682-40-3	685-40-3	686-40-3
M42x1	682-42-3	685-42-3	686-42-3
M45x1	682-45-3	685-45-3	686-45-3
M48x1	682-48-3	685-48-3	686-48-3
M50x1	682-50-3	685-50-3	686-50-3
M52x1	682-52-3	685-52-3	686-52-3
M55x1	682-55-3	685-55-3	686-55-3
M56x1	682-56-3	685-56-3	686-56-3
M58x1	682-58-3	685-58-3	686-58-3
M60x1	682-60-3	685-60-3	686-60-3
M62x1	682-62-3	685-62-3	686-62-3

Thread Plug Gauges and Ring Gauges

68X Series

Plug Gauge 6H		Ring Gauge"GO" 6g	Ring Gauge"NO GO" 6g
Size	Code No.	Code No.	Code No.
ISO-Metric Fine Thread			
M64x1	682-64-3	685-64-3	686-64-3
M65x1	682-65-3	685-65-3	686-65-3
M68x1	682-68-3	685-68-3	686-68-3
M70x1	682-70-3	685-70-3	686-70-3
M72x1	682-72-3	685-72-3	686-72-3
M75x1	682-75-3	685-75-3	686-75-3
M76x1	682-76-3	685-76-3	686-76-3
M78x1	682-78-3	685-78-3	686-78-3
M80x1	682-80-3	685-80-3	686-80-3
M10x1.25	682-10-4	685-10-4	686-10-4
M12x1.25	682-12-4	685-12-4	686-12-4
M14x1.25	682-14-4	685-14-4	686-14-4
M12x1.5	682-12-5	685-12-5	686-12-5
M14x1.5	682-14-5	685-14-5	686-14-5
M16x1.5	682-16-5	685-16-5	686-16-5
M18x1.5	682-18-5	685-18-5	686-18-5
M20x1.5	682-20-5	685-20-5	686-20-5
M22x1.5	682-22-5	685-22-5	686-22-5
M24x1.5	682-24-5	685-24-5	686-24-5
M25x1.5	682-25-5	685-25-5	686-25-5
M26x1.5	682-26-5	685-26-5	686-26-5
M27x1.5	682-27-5	685-27-5	686-27-5
M28x1.5	682-28-5	685-28-5	686-28-5
M30x1.5	682-30-5	685-30-5	686-30-5
M32x1.5	682-32-5	685-32-5	686-32-5
M33x1.5	682-33-5	685-33-5	686-33-5
M34x1.5	682-34-5	685-34-5	686-34-5
M35x1.5	682-35-5	685-35-5	686-35-5
M36x1.5	682-36-5	685-36-5	686-36-5
M38x1.5	682-38-5	685-38-5	686-38-5
M40x1.5	682-40-5	685-40-5	686-40-5
M42x1.5	682-42-5	685-42-5	686-42-5
M45x1.5	682-45-5	685-45-5	686-45-5
M48x1.5	682-48-5	685-48-5	686-48-5
M50x1.5	682-50-5	685-50-5	686-50-5
M52x1.5	682-52-5	685-52-5	686-52-5
M55x1.5	682-55-5	685-55-5	686-55-5
M56x1.5	682-56-5	685-56-5	686-56-5
M58x1.5	682-58-5	685-58-5	686-58-5
M60x1.5	682-60-5	685-60-5	686-60-5
M62x1.5	682-62-5	685-62-5	686-62-5
M64x1.5	682-64-5	685-64-5	686-64-5
M65x1.5	682-65-5	685-65-5	686-65-5
M68x1.5	682-68-5	685-68-5	686-68-5
M70x1.5	682-70-5	685-70-5	686-70-5
M72x1.5	682-72-5	685-72-5	686-72-5
M75x1.5	682-75-5	685-75-5	686-75-5
M76x1.5	682-76-5	685-76-5	686-76-5
M78x1.5	682-78-5	685-78-5	686-78-5
M80x1.5	682-80-5	685-80-5	686-80-5
M18x2	682-18-6	685-18-6	686-18-6
M20x2	682-20-6	685-20-6	686-20-6
M22x2	682-22-6	685-22-6	686-22-6
M24x2	682-24-6	685-24-6	686-24-6
M26x2	682-26-6	685-26-6	686-26-6
M27x2	682-27-6	685-27-6	686-27-6

Plug Gauge 6H		Ring Gauge"GO" 6g	Ring Gauge"NO GO" 6g
Size	Code No.	Code No.	Code No.
M28x2	682-28-6	685-28-6	686-28-6
M30x2	682-30-6	685-30-6	686-30-6
M32x2	682-32-6	685-32-6	686-32-6
M33x2	682-33-6	685-33-6	686-33-6
M34x2	682-34-6	685-34-6	686-34-6
M35x2	682-35-6	685-35-6	686-35-6
M36x2	682-36-6	685-36-6	686-36-6
M38x2	682-38-6	685-38-6	686-38-6
M39x2	682-39-6	685-39-6	686-39-6
M40x2	682-40-6	685-40-6	686-40-6
M42x2	682-42-6	685-42-6	686-42-6
M45x2	682-45-6	685-45-6	686-45-6
M48x2	682-48-6	685-48-6	686-48-6
M50x2	682-50-6	685-50-6	686-50-6
M52x2	682-52-6	685-52-6	686-52-6
M55x2	682-55-6	685-55-6	686-55-6
M56x2	682-56-6	685-56-6	686-56-6
M58x2	682-58-6	685-58-6	686-58-6
M60x2	682-60-6	685-60-6	686-60-6
M62x2	682-62-6	685-62-6	686-62-6
M64x2	682-64-6	685-64-6	686-64-6
M68x2	682-68-6	685-68-6	686-68-6
M70x2	682-70-6	685-70-6	686-70-6
M72x2	682-72-6	685-72-6	686-72-6
M75x2	682-75-6	685-75-6	686-75-6
M76x2	682-76-6	685-76-6	686-76-6
M78x2	682-78-6	685-78-6	686-78-6
M80x2	682-80-6	685-80-6	686-80-6
M82x2	682-82-6	685-82-6	686-82-6
M85x2	682-85-6	685-85-6	686-85-6
M88x2	682-88-6	685-88-6	686-88-6
M90x2	682-90-6	685-90-6	686-90-6
M92x2	682-92-6	685-92-6	686-92-6
M95x2	682-95-6	685-95-6	686-95-6
M98x2	682-98-6	685-98-6	686-98-6
M100x2	683-00-6	685-00-6	686-00-6
M30x3	682-30-7	685-30-7	686-30-7
M33x3	682-33-7	685-33-7	686-33-7
M36x3	682-36-7	685-36-7	686-36-7
M39x3	682-39-7	685-39-7	686-39-7
M40x3	682-40-7	685-40-7	686-40-7
M42x3	682-42-7	685-42-7	686-42-7
M45x3	682-45-7	685-45-7	686-45-7
M48x3	682-48-7	685-48-7	686-48-7
M50x3	682-50-7	685-50-7	686-50-7
M52x3	682-52-7	685-52-7	686-52-7
M55x3	682-55-7	685-55-7	686-55-7
M56x3	682-56-7	685-56-7	686-56-7
M58x3	682-58-7	685-58-7	686-58-7
M60x3	682-60-7	685-60-7	686-60-7
M62x3	682-62-7	685-62-7	686-62-7
M64x3	682-64-7	685-64-7	686-64-7
M65x3	682-65-7	685-65-7	686-65-7
M68x3	682-68-7	685-68-7	686-68-7
M70x3	682-70-7	685-70-7	686-70-7
M72x3	682-72-7	685-72-7	686-72-7

Whitworth Pipe Thread Plug Gauges and Ring Gauges 690 Series

- Right hand, DIN ISO 228

SPECIFICATIONS

	Plug Gauge	Ring Gauge "GO"	Ring Gauge "NO GO"
Size	Code No.	Code No.	Code No.
G1/16	690-01-1	-	-
G1/8	690-02-1	690-02-3	690-02-4
G1/4	690-03-1	690-03-3	690-03-4
G3/8	690-04-1	690-04-3	690-04-4
G1/2	690-05-1	690-05-3	690-05-4
G5/8	690-06-1	690-06-3	690-06-4
G3/4	690-07-1	690-07-3	690-07-4
G7/8	690-08-1	690-08-3	690-08-4
G1	690-09-1	690-09-3	690-09-4

	Plug Gauge	Ring Gauge "GO"	Ring Gauge "NO GO"
Size	Code No.	Code No.	Code No.
G1-1/8	690-10-1	690-10-3	690-10-4
G1-1/4	690-11-1	690-11-3	690-11-4
G1-1/2	690-12-1	690-12-3	690-12-4
G1-3/4	690-13-1	690-13-3	690-13-4
G2	690-14-1	690-14-3	690-14-4
G2-1/4	690-15-1	690-15-3	690-15-4
G2-1/2	690-16-1	690-16-3	690-16-4
G2-3/4	690-17-1	690-17-3	690-17-4
G3	690-18-1	690-18-3	690-18-4

NPT Thread Plug Gauges and Ring Gauges 690 Series

- NPT ANSI/ASME B.1.20.1*

	Plug Gauge	Ring Gauge
Size	Code No.	Code No.
1/8"-27	690-41-1	690-41-3
1/4"-18	690-42-1	690-42-3
3/8"-18	690-43-1	690-43-3
1/2"-14	690-44-1	690-44-3
3/4"-14	690-45-1	690-45-3

	Plug Gauge	Ring Gauge
Size	Code No.	Code No.
1"-11.5	690-46-1	690-46-3
1-1/4"-11.5	690-47-1	690-47-3
1-1/2"-11.5	690-48-1	690-48-3
2"-11.5	690-49-1	690-49-3
2-1/2"-8	690-50-1	690-50-3
3"-8	690-51-1	690-51-3

Inch Master Setting Ring Gauges 679 Series

FEATURES

- Hardened steel



Size	Accuracy	Taper/Ovality	Code No.
.100"	±.00004"	.000012"	679-01-0
.160"	±.00005"	.000015"	679-02-0
.175"	±.00005"	.000015"	679-03-0
.225"	±.00005"	.000015"	679-04-0
.240"	±.00005"	.000015"	679-05-0
.350"	±.00005"	.000015"	679-06-0
.500"	±.00006"	.000019"	679-07-0
.650"	±.00006"	.000019"	679-08-0
1.000"	±.00008"	.000024"	679-09-0
1.400"	±.00008"	.000028"	679-10-0

Size	Accuracy	Taper/Ovality	Code No.
1.800"	±.00008"	.000028"	679-11-0
2.000"	±.00010"	.000031"	679-12-0
2.800"	±.00010"	.000031"	679-13-0
3.600"	±.00012"	.000039"	679-14-0
4.000"	±.00012"	.000039"	679-19-0
5.000"	±.00016"	.000047"	679-15-0
7.000"	±.00016"	.000047"	679-16-0
9.000"	±.00019"	.000055"	679-17-0
11.000"	±.00023"	.000062"	679-18-0

ANSI Inch Thread Plug Gauges and Adjustable Ring Gauges

695 Series

FEATURES

- aluminum handles
- ANSI Standard



695-41-1



695-41-0



695-41-2

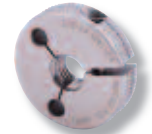

695-32-5

SPECIFICATIONS

	Plug Gauge "GO" (Class 2B)	Plug Gauge "NO GO" (Class 2B)	Plug Gauge Double End (Class 2B)	Ring Gauge "GO" (Class 2A)	Ring Gauge "NO GO" (Class 2A)
Size	Code No.	Code No.	Code No.	Code No.	Code No.
0 - 80	695-01-0	695-01-1	695-01-2	695-01-4	695-01-5
1 - 64	695-02-0	695-02-1	695-02-2	695-02-4	695-02-5
1 - 72	695-03-0	695-03-1	695-03-2	695-03-4	695-03-5
2 - 56	695-04-0	695-04-1	695-04-2	695-04-4	695-04-5
2 - 64	695-05-0	695-05-1	695-05-2	695-05-4	695-05-5
3 - 48	695-06-0	695-06-1	695-06-2	695-06-4	695-06-5
3 - 56	695-07-0	695-07-1	695-07-2	695-07-4	695-07-5
4 - 40	695-08-0	695-08-1	695-08-2	695-08-4	695-08-5
4 - 48	695-09-0	695-09-1	695-09-2	695-09-4	695-09-5
5 - 40	695-10-0	695-10-1	695-10-2	695-10-4	695-10-5
5 - 44	695-11-0	695-11-1	695-11-2	695-11-4	695-11-5
6 - 32	695-12-0	695-12-1	695-12-2	695-12-4	695-12-5
6 - 40	695-13-0	695-13-1	695-13-2	695-13-4	695-13-5
8 - 32	695-14-0	695-14-1	695-14-2	695-14-4	695-14-5
8 - 36	695-15-0	695-15-1	695-15-2	695-15-4	695-15-5
10 - 24	695-16-0	695-16-1	695-16-2	695-16-4	695-16-5
10 - 32	695-17-0	695-17-1	695-17-2	695-17-4	695-17-5
12 - 24	695-18-0	695-18-1	695-18-2	695-18-4	695-18-5
12 - 28	695-19-0	695-19-1	695-19-2	695-19-4	695-19-5
1/4 - 20	695-20-0	695-20-1	695-20-2	695-20-4	695-20-5
1/4 - 28	695-21-0	695-21-1	695-21-2	695-21-4	695-21-5
1/4 - 32	695-22-0	695-22-1	695-22-2	695-22-4	695-22-5
5/16 - 18	695-23-0	695-23-1	695-23-2	695-23-4	695-23-5
5/16 - 24	695-24-0	695-24-1	695-24-2	695-24-4	695-24-5
5-16 - 32	695-25-0	695-25-1	695-25-2	695-25-4	695-25-5
3/8 - 16	695-26-0	695-26-1	695-26-2	695-26-4	695-26-5
3/8 - 24	695-27-0	695-27-1	695-27-2	695-27-4	695-27-5
3/8 - 32	695-28-0	695-28-1	695-28-2	695-28-4	695-28-5
7/16 - 14	695-29-0	695-29-1	695-29-2	695-29-4	695-29-5
7/16 - 20	695-30-0	695-30-1	695-30-2	695-30-4	695-30-5
7/16 - 28	695-31-0	695-31-1	695-31-2	695-31-4	695-31-5
1/2 - 13	695-32-0	695-32-1	695-32-2	695-32-4	695-32-5
1/2 - 20	695-33-0	695-33-1	695-33-2	695-33-4	695-33-5
1/2 - 28	695-34-0	695-34-1	695-34-2	695-34-4	695-34-5
9/16 - 12	695-35-0	695-35-1	695-35-2	695-35-4	695-35-5
9/16 - 18	695-36-0	695-36-1	695-36-2	695-36-4	695-36-5
9/16 - 24	695-37-0	695-37-1	695-37-2	695-37-4	695-37-5
5/8 - 11	695-38-0	695-38-1	695-38-2	695-38-4	695-38-5
5/8 - 18	695-39-0	695-39-1	695-39-2	695-39-4	695-39-5
5/8 - 24	695-40-0	695-40-1	695-40-2	695-40-4	695-40-5
3/4 - 10	695-41-0	695-41-1	695-41-2	695-41-4	695-41-5
3/4 - 16	695-42-0	695-42-1	695-42-2	695-42-4	695-42-5
3/4 - 20	695-43-0	695-43-1	695-43-2	695-43-4	695-43-5
7/8 - 9	695-44-0	695-44-1	695-44-2	695-44-4	695-44-5
7/8 - 14	695-45-0	695-45-1	695-45-2	695-45-4	695-45-5
7/8 - 20	695-46-0	695-46-1	695-46-2	695-46-4	695-46-5
1 - 8	695-47-0	695-47-1	695-47-2	695-47-4	695-47-5
1 - 12	695-48-0	695-48-1	695-48-2	695-48-4	695-48-5

ANSI Metric Thread Plug Gauges and Ring Gauges

696 Series

FEATURES

- Aluminum handles
- ANSI Standard

SPECIFICATIONS

Size	Plug Gauge "GO" (6H)	Plug Gauge "NO GO" (6H)	Plug Gauge Double End (6H)	Ring Gauge "GO" (6g)	Ring Gauge "NO GO" (6g)
Code No.	Code No.	Code No.	Code No.	Code No.	Code No.
M1.6 X 0.35	696-01-0	696-01-1	696-01-2	-	-
M1.8 X 0.35	696-02-0	696-02-1	696-02-2	-	-
M2 X 0.4	696-03-0	696-03-1	696-03-2	-	-
M2.2 X 0.45	696-04-0	696-04-1	696-04-2	-	-
M2.5 X 0.45	696-05-0	696-05-1	696-05-2	696-05-4	696-05-5
M3 X 0.5	696-06-0	696-06-1	696-06-2	696-06-4	696-06-5
M3.5 X 0.6	696-07-0	696-07-1	696-07-2	696-07-4	696-07-5
M4 X 0.7	696-08-0	696-08-1	696-08-2	696-08-4	696-08-5
M4.5 X 0.75	696-09-0	696-09-1	696-09-2	696-09-4	696-09-5
M5 X 0.8	696-10-0	696-10-1	696-10-2	696-10-4	696-10-5
M6 X 1	696-11-0	696-11-1	696-11-2	696-11-4	696-11-5
M7 X 1	696-12-0	696-12-1	696-12-2	696-12-4	696-12-5
M8 X 1	696-13-0	696-13-1	696-13-2	696-13-4	696-13-5
M8 X 1.25	696-14-0	696-14-1	696-14-2	696-14-4	696-14-5
M10 X 1.25	696-15-0	696-15-1	696-15-2	696-15-4	696-15-5
M10 X 1.5	696-16-0	696-16-1	696-16-2	696-16-4	696-16-5
M12 X 1.25	696-17-0	696-17-1	696-17-2	696-17-4	696-17-5
M12 X 1.75	696-18-0	696-18-1	696-18-2	696-18-4	696-18-5
M14 X 1.5	696-19-0	696-19-1	696-19-2	696-19-4	696-19-5
M14 X 2	696-20-0	696-20-1	696-20-2	696-20-4	696-20-5
M16 X 1.5	696-21-0	696-21-1	696-21-2	696-21-4	696-21-5
M16 X 2	696-22-0	696-22-1	696-22-2	696-22-4	696-22-5
M18 X 1.5	696-23-0	696-23-1	696-23-2	696-23-4	696-23-5
M18 X 2.5	696-24-0	696-24-1	696-24-2	696-24-4	696-24-5
M20 X 1.5	696-25-0	696-25-1	696-25-2	696-25-4	696-25-5
M20 X 2.5	696-26-0	696-26-1	696-26-2	696-26-4	696-26-5
M22 X 1.5	696-27-0	696-27-1	696-27-2	696-27-4	696-27-5
M24 X 2	696-28-0	696-28-1	696-28-2	696-28-4	696-28-5
M24 X 3	696-29-0	696-29-1	696-29-2	696-29-4	696-29-5
M27 X 2	696-30-0	696-30-1	696-30-2	696-30-4	696-30-5
M27 X 3	696-31-0	696-31-1	696-31-2	696-31-4	696-31-5
M30 X 2	696-32-0	696-32-1	696-32-2	696-32-4	696-32-5
M30 X 3.5	696-33-0	696-33-1	696-33-2	696-33-4	696-33-5
M33 X 2	696-34-0	696-34-1	696-34-2	696-34-4	696-34-5
M33 X 3.5	696-35-0	696-35-1	696-35-2	696-35-4	696-35-5
M36 X 3	696-36-0	696-36-1	696-36-2	696-36-4	696-36-5
M36 X 4	696-37-0	696-37-1	696-37-2	696-37-4	696-37-5
M39 X 3	696-38-0	696-38-1	696-38-2	696-38-4	696-38-5
M39 X 4	696-39-0	696-39-1	696-39-2	696-39-4	696-39-5

Individual Inspection Gauge Balls

679 Series

FEATURES

- Chrome steel hardened to 63 HRC.
- Ground and lapped.
- Grade 25 accuracy - AFBMA certified.
- Certificate NOT supplied with individual gauge balls.



SPECIFICATIONS

Size	Code No.	Size	Code No.
1/16"	679-22-0	1/2"	679-38-0
3/32"	679-24-0	17/32"	679-39-0
1/8"	679-25-0	9/16"	679-40-0
9/64"	679-26-0	19/32"	679-41-0
5/32"	679-27-0	5/8"	679-42-0
3/16"	679-28-0	21/32"	679-43-0
7/32"	679-29-0	11/16"	679-44-0
1/4"	679-30-0	23/32"	679-45-0
9/32"	679-31-0	3/4"	679-46-0
5/16"	679-32-0	25/32"	679-47-0
11/32"	679-33-0	13/16"	679-48-0
3/8"	679-34-0	7/8"	679-49-0
13/32"	679-35-0	15/16"	679-50-0
7/16"	679-36-0	1"	679-51-0
15/32"	679-37-0		

Size	Code No.	Size	Code No.
1mm	679-57-0	14mm	679-70-0
2mm	679-58-0	15mm	679-71-0
3mm	679-59-0	16mm	679-72-0
4mm	679-60-0	17mm	679-73-0
5mm	679-61-0	18mm	679-74-0
6mm	679-62-0	19mm	679-75-0
7mm	679-63-0	20mm	679-76-0
8mm	679-64-0	21mm	679-77-0
9mm	679-65-0	22mm	679-78-0
10mm	679-66-0	23mm	679-79-0
11mm	679-67-0	24mm	679-80-0
12mm	679-68-0	25mm	679-81-0
13mm	679-69-0		

Precision Inspection Gauge Ball Sets

679 Series

FEATURES

- Meets all grade 25 AFBMA standards.
- Chrome alloy steel, hardened to 63 HRC.
- Surface finish to 1.5 Micro-Inches.
- Within .0001"/0.0025 mm of actual size.
- Spherical accuracy within 0.000025"/0.0006 mm.
- Inches - includes: 32 pairs in Inch sizes 1/32" to 1".
- Metric - includes: 25 pairs in Metric sizes 1mm to 25 mm in 1 mm increments.



SPECIFICATIONS

	QTY	Description	Code No.
Ball Set - Inches	32 Pair	1/32" to 1"	679-90-1
Ball Set - Metric	25 Pair	1mm to 25 mm in 1 mm increments	679-90-0

36 pcs Round Space Block Set

679 Series

FEATURES

- For quickly setting stops and set ups in lathes, milling machines, drill presses, etc. Also excellent for setting sine bars.
- Each block marked for size. Overall diameter: .750".
- 1/4"-28 threaded hole through center of block.
- Working surfaces hardened to HRC 58-60.
- Working surfaces precision ground and lapped to $\pm .000050"$.
- 4 connecting screws supplied to form desired length.



SPECIFICATIONS

Description	Included	Code No.
36 PCS Set	.050, .060, .0625, .070, .080, .090, .100, .101, .102, .103, .104, .105, .106, .107, .108, .109, .110, .120, .125, .130, .140, .150, .160, .170, .180, .190, .200, .300, .400, .500, .600, .700, .800, .900, 1.00 (2 ea.)	679-95-0

Thread Measuring Wire Set

697 Series

FEATURES

- 48 wires — 16 different sizes.
- Measures all threads from 3 - 48 threads per inch.
- Measures all metric threads from 0.5 mm to 6 mm.
- Also measures ACME threads.
- Laminated chart included.

SPECIFICATIONS

Code No.
697-30-0

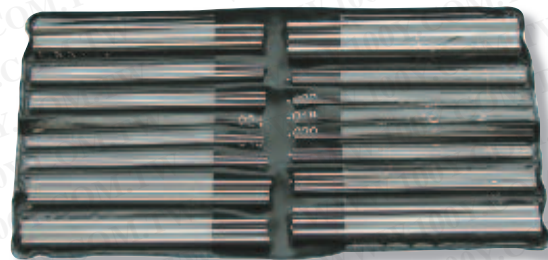

Individual Pin Gauges

FEATURES

- Black Oxide coating prevents corrosion and shows gauge wear.
- J Series

SPECIFICATIONS

Inch		Bright Finish	Black Oxide Finish
Size	Tolerance	Code No.	Code No.
.011" - 1.000" x 0.001 step	+0/-0.0002 Minus	21-0011 to 21-1000	23-0011 to 23-1000
.011" - 1.000" x 0.001 step	+0.0002/-0 Plus	22-0011 to 22-1000	24-0011 to 24-1000



Metric			Metric		
Size	Accuracy	Code No.	Size	Accuracy	Code No.
0.05 - 0.09 x 0.01 step	±0.0005	800-00-5 to 800-009	0.20 - 0.29 x 0.01 step	+0/+0.005	812-44-2 to 812-45-2
0.10 - 10.00 x 0.01 step	±0.0008	800-01-0 to 809-92-0	0.300 - 12.975 x 0.025 step	-0.005/+0	812-45-3 to 812-96-9
10.005 - 20.000 x 0.01 step	±0.0015	809-92-1 to 811-43-1	13.0 - 19.0 x 0.1 step	+0/+0.005	812-97-0 to 813-03-0
20.01 - 30.00 x 0.01 step	±0.0020	811-43-2 to 812-44-1	13.0 - 19.0 x 0.1 step	-0.005/+0	813-03-1 to 813-09-1

Pin Gauge Sets

697 Series

FEATURES

- For quick and accurate measurements. Measure hole sizes, slot widths, calculate distances between holes, use as Go/NoGo gaging, etc.
- Each set includes pin gauge holder.
- Furnished in attractive molded plastic case.
- Class ZZ guaranteed to .0002"/0.005 mm tolerance limit.
- Inspected with equipment which has been calibrated and is traceable to NIST.
- Marked with size and direction of tolerance on gauge over .060"/1.5 mm.
- Hardened drill rod RC 60-62, 2 inches long.
- 10 micron finish or better.
- Black Oxide coating prevents corrosion and shows gauge wear.
- Certificate of accuracy included.



SPECIFICATIONS

Qty	Range	Surface	Accuracy: +0.0002" -0"		Accuracy: -0.0002" +0"	
			Code No.	Code No.	Code No.	Code No.
Sets						
50	.011" - .060" x 0.001 step	Bright Finish	697-01-0		697-01-2	
190	.061" - .250" x 0.001 step	Bright Finish	697-02-0		697-02-2	
250	.251" - .500" x 0.001 step	Bright Finish	697-03-0		697-03-2	
125	.501" - .625" x 0.001 step	Bright Finish	697-04-0		697-04-2	
125	.626" - .750" x 0.001 step	Bright Finish	697-05-0		697-05-2	
82	.751" - .832" x 0.001 step	Bright Finish	697-06-0		697-06-2	
84	.833" - .916" x 0.001 step	Bright Finish	697-07-0		697-07-2	
84	.917" - 1.000" x 0.001 step	Bright Finish	697-08-0		697-08-2	
50	.011" - .060" x 0.001 step	Black Oxide Finish	697-09-0		697-09-2	
190	.061" - .250" x 0.001 step	Black Oxide Finish	697-10-0		697-10-2	
250	.251" - .500" x 0.001 step	Black Oxide Finish	697-11-0		697-11-2	
125	.501" - .625" x 0.001 step	Black Oxide Finish	697-12-0		697-12-2	
125	.626" - .750" x 0.001 step	Black Oxide Finish	697-13-0		697-13-2	
82	.751" - .832" x 0.001 step	Black Oxide Finish	697-14-0		697-14-2	
84	.833" - .916" x 0.001 step	Black Oxide Finish	697-15-0		697-15-2	
84	.917" - 1.000" x 0.001 step	Black Oxide Finish	697-16-0		697-16-2	

Pin Gauge Sets

698 \ 699 Series

FEATURES

- J Series

SPECIFICATIONS

Qty	Range	Code No.	Qty	Range	Code No.
24	0.06 - 0.29mm x 0.01mm step	698-20-0	51	0.50 - 0.75mm x 0.005mm step	698-20-1
31	0.20 - 0.50mm x 0.01mm step	698-21-0	51	0.75 - 1.00mm x 0.005mm step	698-21-1
51	0.50 - 1.00mm x 0.01mm step	698-22-0	51	1.00 - 1.25mm x 0.005mm step	698-22-1
51	1.00 - 1.50mm x 0.01mm step	698-23-0	51	1.25 - 1.50mm x 0.005mm step	698-23-1
51	1.50 - 2.00mm x 0.01mm step	698-24-0	51	1.50 - 1.75mm x 0.005mm step	698-24-1
51	2.00 - 2.50mm x 0.01mm step	698-25-0	51	1.75 - 2.00mm x 0.005mm step	698-25-1
51	2.50 - 3.00mm x 0.01mm step	698-26-0	51	2.00 - 2.25mm x 0.005mm step	698-26-1
51	3.00 - 3.50mm x 0.01mm step	698-27-0	51	2.25 - 2.50mm x 0.005mm step	698-27-1
51	3.50 - 4.00mm x 0.01mm step	698-28-0	51	2.50 - 2.75mm x 0.005mm step	698-28-1
51	4.00 - 4.50mm x 0.01mm step	698-29-0	51	2.75 - 3.00mm x 0.005mm step	698-29-1
51	4.50 - 5.00mm x 0.01mm step	698-30-0	51	3.00 - 3.25mm x 0.005mm step	698-30-1
51	5.00 - 5.50mm x 0.01mm step	698-31-0	51	3.25 - 3.50mm x 0.005mm step	698-31-1
51	5.50 - 6.00mm x 0.01mm step	698-32-0	51	3.50 - 3.75mm x 0.005mm step	698-32-1
51	6.00 - 6.50mm x 0.01mm step	698-33-0	51	3.75 - 4.00mm x 0.005mm step	698-33-1
51	6.50 - 7.00mm x 0.01mm step	698-34-0	51	4.00 - 4.25mm x 0.005mm step	698-34-1
51	7.00 - 7.50mm x 0.01mm step	698-35-0	51	4.25 - 4.50mm x 0.005mm step	698-35-1
51	7.50 - 8.00mm x 0.01mm step	698-36-0	51	4.50 - 4.75mm x 0.005mm step	698-36-1
51	8.00 - 8.50mm x 0.01mm step	698-37-0	51	4.75 - 5.00mm x 0.005mm step	698-37-1
51	8.50 - 9.00mm x 0.01mm step	698-38-0	51	5.00 - 5.25mm x 0.005mm step	698-38-1
51	9.00 - 9.50mm x 0.01mm step	698-39-0	51	5.25 - 5.50mm x 0.005mm step	698-39-1
51	9.50 - 10.00mm x 0.01mm step	698-40-0	51	5.50 - 5.75mm x 0.005mm step	698-40-1
51	10.00 - 10.50mm x 0.01mm step	698-41-0	51	5.75 - 6.00mm x 0.005mm step	698-41-1
51	10.50 - 11.00mm x 0.01mm step	698-42-0	51	6.00 - 6.25mm x 0.005mm step	698-42-1
51	11.00 - 11.50mm x 0.01mm step	698-43-0	51	6.25 - 6.50mm x 0.005mm step	698-43-1
51	11.50 - 12.00mm x 0.01mm step	698-44-0	51	6.50 - 6.75mm x 0.005mm step	698-44-1
51	12.00 - 12.50mm x 0.01mm step	698-45-0	51	6.75 - 7.00mm x 0.005mm step	698-45-1
51	12.50 - 13.00mm x 0.01mm step	698-46-0	51	7.00 - 7.25mm x 0.005mm step	698-46-1
51	13.00 - 13.50mm x 0.01mm step	698-47-0	51	7.25 - 7.50mm x 0.005mm step	698-47-1
51	13.50 - 14.00mm x 0.01mm step	698-48-0	51	7.50 - 7.75mm x 0.005mm step	698-48-1
51	14.00 - 14.50mm x 0.01mm step	698-49-0	51	7.75 - 8.00mm x 0.005mm step	698-49-1
51	14.50 - 15.00mm x 0.01mm step	698-50-0	51	8.00 - 8.25mm x 0.005mm step	698-50-1
51	15.00 - 15.50mm x 0.01mm step	698-51-0	51	8.25 - 8.50mm x 0.005mm step	698-51-1
51	15.50 - 16.00mm x 0.01mm step	698-52-0	51	8.50 - 8.75mm x 0.005mm step	698-52-1
51	16.00 - 16.50mm x 0.01mm step	698-53-0	51	8.75 - 9.00mm x 0.005mm step	698-53-1
51	16.50 - 17.00mm x 0.01mm step	698-54-0	51	9.00 - 9.25mm x 0.005mm step	698-54-1
51	17.00 - 17.50mm x 0.01mm step	698-55-0	51	9.25 - 9.50mm x 0.005mm step	698-55-1
51	17.50 - 18.00mm x 0.01mm step	698-56-0	51	9.50 - 9.75mm x 0.005mm step	698-56-1
51	18.00 - 18.50mm x 0.01mm step	698-57-0	51	9.75 - 10.00mm x 0.005mm step	698-57-1
51	18.50 - 19.00mm x 0.01mm step	698-58-0	50	0.300 - 1.525mm x 0.025mm step	699-21-0
51	19.00 - 19.50mm x 0.01mm step	698-59-0	190	1.550 - 6.275mm x 0.025mm step	699-22-0
51	19.50 - 20.00mm x 0.01mm step	698-60-0	140	6.300 - 9.775mm x 0.025mm step	699-23-0
20	0.10 - 0.29mm x 0.01mm step	699-20-0	110	9.800 - 12.525mm x 0.025mm step	699-24-0
61	13.0 - 19.0mm x 0.1mm step	699-26-0	18	12.550 - 12.975mm x 0.025mm step	699-25-0

Pin Gauge Handles

697 Series

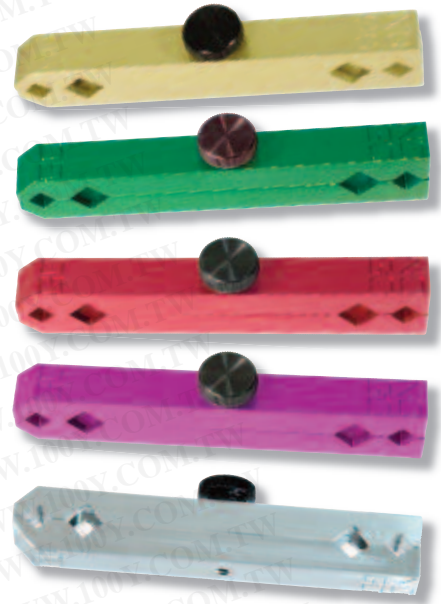
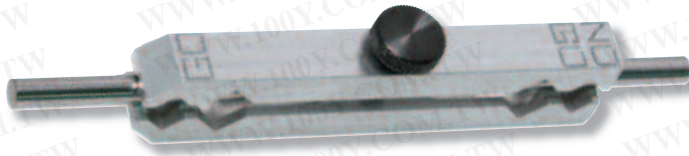

FEATURES

- Machined from solid Aluminum, this premium handle can hold diameters from 1/32" to 1/2".
- Go and No Go marked on gauge.
- Completely self contained, does not use any bushings.
- Available in plain Aluminum, or Green, Purple, Red, or Yellow Anodized Aluminum

SPECIFICATIONS

Pin Gauge Handles	Code No.
Aluminum	697-40-0
Green Anodized Aluminum	697-40-1
Purple Anodized Aluminum	697-40-2
Red Anodized Aluminum	697-40-3
Yellow Anodized Aluminum	697-40-4

Pin Gauge Handles

697 Series



FEATURES

- Comfortable, ergonomically designed handle for pin gauge.
- Can be used with GO pin (green) on one end, NO GO pin (red) on opposite end.

SPECIFICATIONS

Gage Size Range	Code No.
0.011" - 0.060"	697-41-0
0.061" - 0.250"	697-41-1
0.251" - 0.500"	697-41-2
0.501" - 0.625"	697-41-3
0.626" - 0.750"	697-41-4
0.751" - 0.832"	697-41-5
0.833" - 1.000"	697-41-6

Testers & Optical Instrument

171	Coordinate Measuring Machine
174	CMM Probes
178	2D Vision Measuring System
180	ViewMeasure
181	Concentricity Gauges
182	Vertical Profile Projectors
183	Surface Roughness Tester
183	Surface Roughness Standards
184	Digital Coating Thickness Gauges
184	Shore Scale A Durometer
185	Rockwell Type Hardness Testers
185	Digital Twin Rockwell Hardness Tester
186	Touch Screen Rockwell Type Hardness Testers
186	Brinell Hardness Testers
187	Impact Hardness Testers
187	Hardness Test Blocks
188	Microscope
191	Microscope accessories

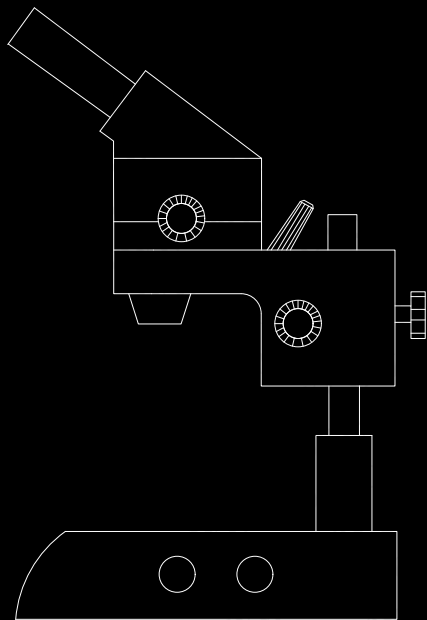



Coordinate Measuring Machine

648 Series





Coordinate Measuring Machine

648 Series

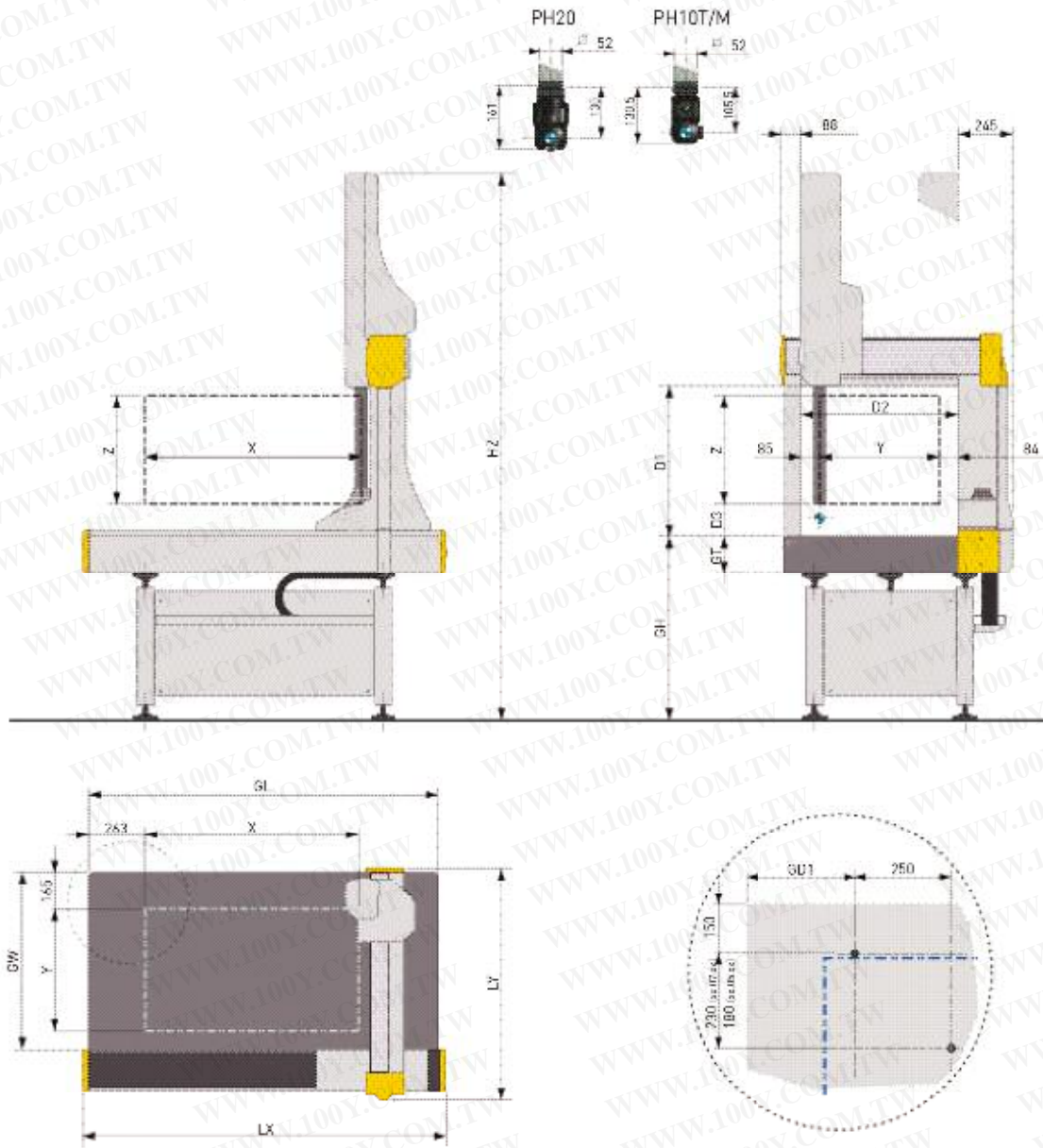



Coordinate Measuring Machine

648 Series

STRUCTURE

- Coordinate Measuring Machine, CNC type, with aluminum alloy mobile bridge structure on granite table machine base
Guideways:
X axis: dovetail guideways machined into the granite table
Y axis: micromachined anodized light alloy extrusion
Z axis: micromachined anodized light alloy extrusion or silicon Carbide (Value+)
- CNC drive via DC motors with zero hysteresis friction drive on steel bar on all axes
- Sliding System: Air bearings on all axes
- Motion Control: DC Servomotor on all axes
- Thermal Compensation: Multi-sensors temperature compensation system (total 4 sensors) in Option
- Measuring system: High resolution (0.1µm) free floating linear scales mounted in carriers
- U series

ENVIRONMENT

- Temperature Range for metrological Specification:
- Operating Temperature: 15-35°C
- Relative Humidity: 40-80% (non condensing)
- Acceptable Vibrations:(vibration acceleration between peaks)
30 mm/s² from 1 to 10Hz
15 mm/s² from 10 to 20Hz
50 mm/s² from 20 to 100Hz

Optional: Metrology Room or CMM protection system

SPECIFICATIONS

Code No.	Measuring Strokes			PH10T/M/PH20-TP20		Weights	
	X	Y	Z	MPE _c	MPE _c	Max. Part Weight	Machine Weight
	[mm]			[µm]		[kg]	
Value							
648-01-0	500	500	500	2.5+L/300	2.2	300	470
648-01-1	700	500	500	2.5+L/300	2.2	300	540
648-01-2	700	650	500	2.5+L/300	2.5	650	775
648-01-3	1000	650	500	2.5+L/300	2.5	700	925
648-01-4	1200	650	500	2.5+L/300	2.5	700	990
Value+							
648-11-0	500	500	500	2.0+L/300	2.0	300	470
648-11-1	700	500	500	2.0+L/300	2.0	300	540
648-11-2	700	650	500	2.1+L/300	2.1	650	775
648-11-3	1000	650	500	2.1+L/300	2.1	700	925
648-11-4	1200	650	500	2.1+L/300	2.1	700	990
648-11-5	700	650	650	2.5+L/300	2.5	650	800
648-11-6	1000	650	650	2.5+L/300	2.5	700	950
648-11-7	1200	650	650	2.5+L/300	2.5	700	1015

Performance data are only valid if the following specifications are met:

- PH10T/M/PH20-TP20/TP200: Tip diameter Ø 4 mm x Stylus length 10 mm
- L = measuring length in mm
- CMM equipped with Multisensor temperature compensation system (Optional)

Ambient temperature Range:

- 18 - 22 °C; Max. Gradients : 0,5 °K/h - 2,0 °K/24h - 0,5 °K/m
- Maximum Permissible Error of indication for size measurement according ISO 10360-2
- Maximum Permissible Probing Error according ISO 10360-2



CMM Styli - M2 Thread

478 Series

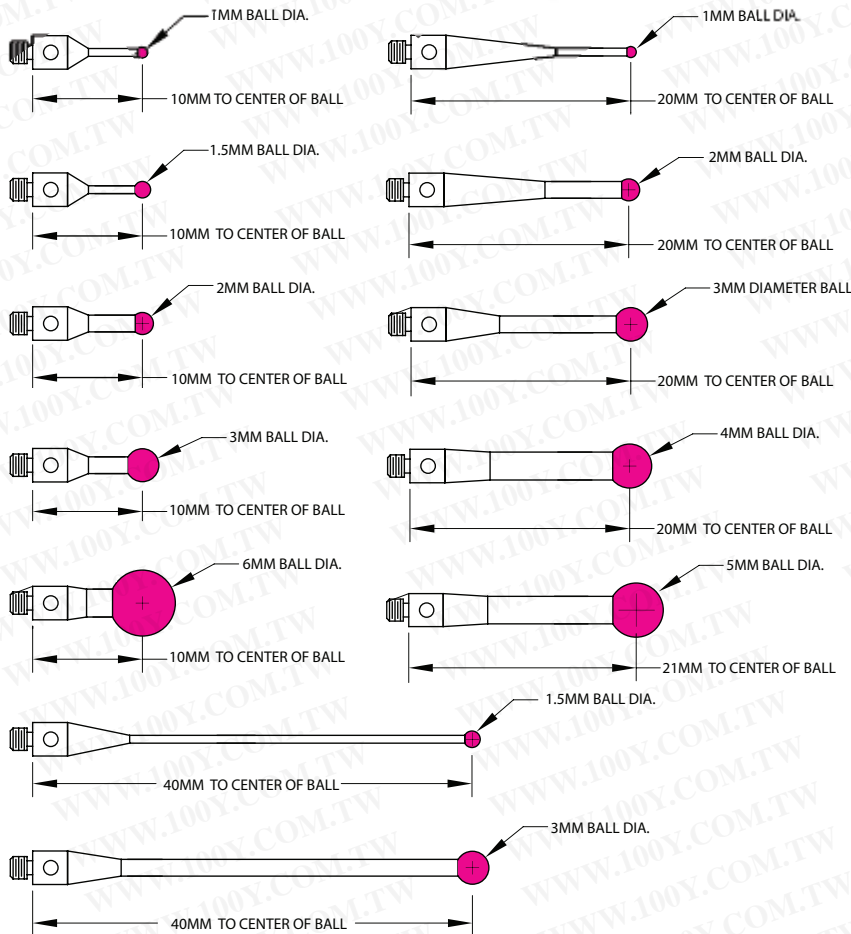

SPECIFICATIONS

Ball Size	Length	Renishaw Functional Equivalent	Carbide Probes	SPI	Q Mark	Code No.
1mm Ruby	10mm		265-1R	12-620-1	TM2-1010	478-01-6
1.5mm Ruby	10mm	PS24R A/5000/7802	-	-	TM2-1510	478-02-6
2mm Ruby	10mm	PS8R A/5000/7807	-	14-987-2	TM2-2010	478-03-6
3mm Ruby	10mm	PS1R A/5000/3604	-	14-988-0	TM2-3010	478-04-6
6mm Ruby	10mm	PS14R A/5000/4156	265-6R	12-625-0	TM2-6010	478-05-6
8mm Ruby	12mm	PS15R A/5000/4158	265-8R	12-626-8	TM2-8015	478-06-6
1mm Ruby	20mm	PS23R A/5000/7808	266-1R	12-621-9	TM2-1020-07	478-07-6
1.5mm Ruby	20mm			-		478-08-6
2mm Ruby	20mm	PS2R A/5000/3603	266-2R	12-622-7	TM2-2020	478-09-6
3mm Ruby	20mm	PS16R A/5000/4160	266-3R	12-623-5	TM2-3020	478-10-6
4mm Ruby	20mm	PS17R A/5000/4161	266-4R	12-624-3	TM2-4020	478-11-6
5mm Ruby	21mm			-		478-12-6
1.5mm Ruby	40mm			-		478-13-6
3mm Ruby	40mm			-		478-14-6



CMM Styli - M3 Thread

478 Series

Ball Size	Length	Renishaw Functional Equivalent	Carbide Probes	Q Mark	Code No.
1mm Ruby	10mm				478-20-6
6mm Ruby	10mm				478-21-6
8mm Ruby	12mm				478-22-6
1mm Ruby	20mm	PS1-9R A/5000/3551	261-1R	TM3-1020	478-23-6
2mm Ruby	20mm	PS1-10R A/5000/3552	261-2R	TM3-2020	478-24-6
3mm Ruby	20mm	PS1-11R A/5000/3553	261-3R	TM3-3020	478-25-6
4mm Ruby	20mm	PS1-12R A/5000/7606	261-4R	TM3-4020	478-26-6
5mm Ruby	21mm	PS1-13R A/5000/7630	-	TM3-5020	478-27-6

CMM Styli - M4 Thread

478 Series

Ball Size	Length	Renishaw Functional Equivalent	Carbide Probes	Code No.
1mm Ruby	10mm			478-30-6
6mm Ruby	10mm			478-31-6
8mm Ruby	12mm			478-32-6
1mm Ruby	20mm	PS2-3R A/5000/7545	840-1R	478-33-6
2mm Ruby	20mm	PS2-4R A/5000/7547	840-2R	478-34-6
3mm Ruby	20mm	PS2-5R A/5000/7549	840-3R	478-35-6
4mm Ruby	20mm	PS2-6R A/5000/7551	840-4R	478-36-6
5mm Ruby	21mm			478-37-6

Cylinder Styli

478 Series

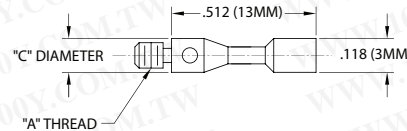

Thread	Cylinder Diameter	Styli Length	Base Diameter (C)	Code No.
M2 x 0.4	3mm	13mm	3mm	478-50-6
M3 x 0.5	3mm	13mm	3mm	478-51-6
M4 x 0.5	3mm	13mm	4.75mm	478-52-6

CMM Styli Universal Wrench

478 Series

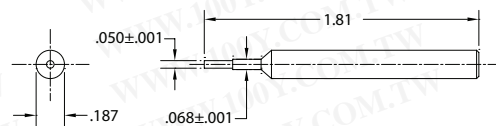

Code No.
478-55-6



CMM Extensions - M2 Thread

478 Series

• Stainless Steel

Length	Diameter	Renishaw Functional Equivalent	Carbide Probes	SPI	Q Mark	Code No.
5mm	3mm					478-60-6
10mm	3mm	SE4 M/5000/3647	265-E10	12-631-8	VM2-10	478-61-6
20mm	3mm	SE5 M/5000/3648	265-E20	12-632-6	VM2-20	478-62-6
30mm	3mm	SE6 M/5000/4162	265-E30	12-633-4	VM2-30	478-63-6
35mm	3mm					478-64-6
40mm	3mm	SE18 M/5000/7779	265-E40	14-983-1	VM2-40	478-65-6
60mm	3mm			14-984-9		478-66-6



CMM Extensions - M3 Thread

478 Series

Length	Diameter	Renishaw Functional Equivalent	Carbide Probes	Q Mark	Code No.
10mm	4mm	SE8 M/5000/7633	261-E10	VM3-10	478-70-6
20mm	4mm	SE2 M/5000/3592	261-E20	VM3-20	478-71-6
30mm	4mm		261-E30		478-72-6
35mm	4mm	M/5000/3593	261-E35	VM3-35	478-73-6
40mm	4mm	M/5000/3593			478-74-6
60mm	4mm				478-75-6



CMM Extensions - M4 Thread

478 Series

Length	Diameter	Renishaw Functional Equivalent	Carbide Probes	Q Mark	Code No.
10mm	6.3mm		823-E10	VM4-10	478-80-6
20mm	6.3mm		823-E20	VM4-20	478-81-6
30mm	6.3mm		823-E30	VM4-30	478-82-6
35mm	6.3mm				478-83-6
40mm	6.3mm				478-84-6
60mm	6.3mm				478-85-6



CMM Adaptor Tips

478 Series

• Converts your probe head to a different thread size, allowing multiple uses of CMM Styli or accessories.

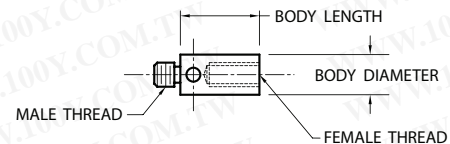

Male Thread	Female Thread	Body Dia.	Body Length	Renishaw Functional Equivalent	Carbide Probes	Fowler	Q Mark	Code No.
M3 x 0.5	M2 x 0.4	4mm	5mm	SA3 M/5000/4163	261-AD5	14-986-4	RM3-M2	478-90-6
M2 x 0.4	M3 x 0.5	4mm	10mm	SA2 M/5000/4164	265-AD7	14-979-9	RM2-M3	478-91-6
M4 x 0.7	M2 x 0.4	6.3mm	5mm	SA5 M/5000/6622	399	14-980-7		478-92-6
M2 x 0.4	M4 x 0.7	6.3mm	15mm			14-981-5	RM4-M2	478-93-6
M4 x 0.7	M3 x 0.5	6.3mm	10mm	SA6 M/5000/6714		14-982-3		478-94-6



CMM Crossheads

478 Series

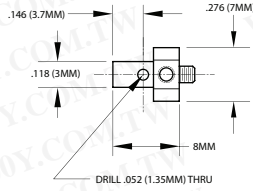

Code No.
478-56-6

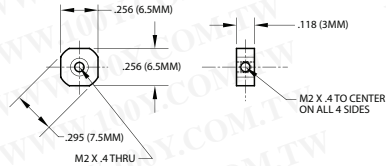

Code No.
478-57-6

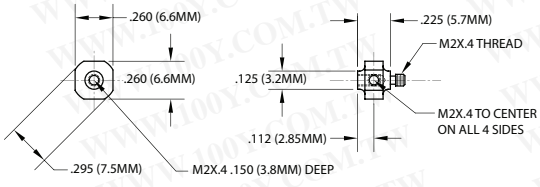
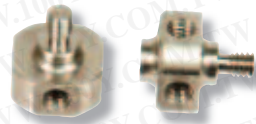

Code No.
478-58-6

CMM Styli Knuckle

478 Series

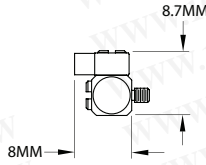

Code No.
478-59-6

CMM Star Styli

478 Series

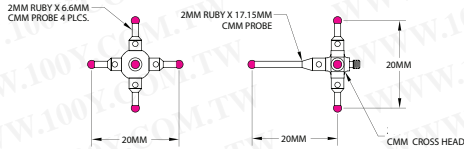

6 PCS Set Code No.: 478-53-6		
Kit contains:	QTY	Description
CMM Crosshead	1	6.6mm x 6.6mm x 5.7mm, M2 x 0.4
Ruby Ball Probe	1	2mm x 17.2mm
Ruby Ball Probe	4	2mm x 6.6mm

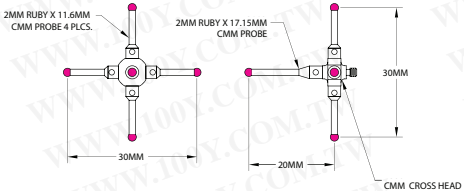
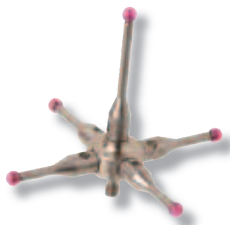

6 PCS Set Code No.: 478-54-6		
Kit contains:	QTY	Description
CMM Crosshead	1	6.6mm x 6.6mm x 5.7mm, M2 x 0.4
Ruby Ball Probe	1	2mm x 17.2mm
Ruby Ball Probe	4	2mm x 11.6mm



2D Vision Measuring System

647 Series

FEATURES

- Manual machine, excellent vision measuring system for 2D measurement on wide range of workpiece.
- High quality optics for light intensive and sharp three dimensional images
- Ergonomic hand wheel, be mounted on both side, ideal for either a left or right handed operator.
- Quick release system on stage, can be switched instantly between coarse and fine movement
- Robust cast stand
- Stable XY table precision mounted
- T Series

Characteristics of the M3 software

- Advanced video probe toolbox.
- programmable light control.
- Advanced Edge Teach.
- Graphics-based "Part View" constructions
- Quick Annotate and Markup.
- Geometric tolerancing.
- Feature Detail Graphics.
- DXF Overlay and FOV capability.
- Part programs and playback
- Flexible Report Content and Formatting



SPECIFICATIONS

Code No.	647-01-0	647-02-0	647-03-0
Model	VMS-1510	VMS-2020	VMS-3030
Measuring Range	150 x 100 x 130 mm (x,y,z)	200 x 200 x 180 mm (x,y,z)	300 x 300 x 130 mm (x,y,z)
Resolution	0.5 μm (x,y)	0.5 μm (x,y)	0.5 μm (x,y)
Vision	CCD +Zoom	CCD +Zoom	CCD +Zoom
Zoom	10X ... 100X (Option 20X ~ 200X)	10X ... 100X (Option 20X ~ 200X)	10X ... 100X (Option 20X ~ 200X)
Surface Light	White LED Light(Option of Coaxial Light)	White LED Light(Option of Coaxial Light)	White LED Light(Option of Coaxial Light)
Contour Light	Green LED	Green LED	Green LED
Accuracy	3+L/200 μm	3+L/200 μm	3+L/200 μm
Repeatability	0.002mm	0.002mm	0.002mm
Transmission	Linear Guideway + Rolling Drive Nut	Linear Guideway + Rolling Drive Nut	Linear Guideway + Rolling Drive Nut
Operation	Manual	Manual	Manual
Demo-parts Height	100mm	150mm	120mm
Demo-parts Weight	5 Kgs	10 Kgs	10 Kgs
Dimension	36 x 65 x 78 cm	67 x 60 x 95 cm	77 x 100 x 95 cm
Machine Weight	60 Kgs	105 Kgs	150 Kgs
Measuring Software	M3	M3	M3

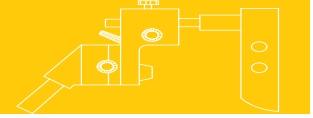

2D Vision Measuring System

647 Series

FEATURES

- CNC machine motorized with joystick, meet variety of measurement needs, such as: IC electronics, Lead Frame and the related manufacturers in the fields of LCD, Semiconductor, P.C, Board, Film, Screen Printing WireCut, E.D.M, Rubber, Plastic, Precise Mold & Dies and so on 2D workpiece machining.
- Options of Centering Microscope, CCD Camera, Laser and so on several projection system depends on the different workpiece.
- The multi-function IK5000 effects the 2D geometric measurement of Point, Line, Circle, Arc, Angle, Distance, Pitching, Alignment, and with the RS232 port.



SPECIFICATIONS

Code No.	647-01-1	647-02-1	647-03-1
Model	VMS-2020-CNC	VMS-3020-CNC	VMS-3030-CNC
Measuring Range	200 x 200 x 180 mm (x,y,z)	300 x 200 x 100 mm (x,y,z)	300 x 300 x 200 mm (x,y,z)
Resolution	0.5 μm in Axes	0.5 μm in Axes	0.5 μm in Axes
Vision	Color CCD +Zoom	Color CCD +Zoom	Color CCD +Zoom
Zoom	10X ... 100X (Option 20X ~ 200X)	10X ... 100X (Option 20X ~ 200X)	10X ... 100X (Option 20X ~ 200X)
Surface Light	White LED Light(Option of Coaxial Light)	White LED Light(Option of Coaxial Light)	White LED Light(Option of Coaxial LED)
Contour Light	Green LED	Green LED	Green LED
Accuracy	3+L/200 μm	2+L/200 μm	3+L/200 μm
Repeatability	0.002mm	0.002mm	0.002mm
Drive	Servo Motors + Joystick	Servo Motors + Joystick	Servo Motors + Joystick
Transmission	Linear Guideway + Rolling Drive Nut	Linear Guideway + Rolling Drive Nut	Linear Guideway + Rolling Drive Nut
Operation	CNC Programmable	CNC Programmable	CNC Programmable
Demo-parts Height	150mm	85mm	200mm
Demo-parts Weight	10 Kgs	12 Kgs	12 Kgs
Dimension	67 x 60 x 95 cm	89 x 82 x 109 cm	77 x 100 x 93 cm
Machine Weight	105 Kgs	382 Kgs	360 Kgs
Measuring Software	IK5000-VED-CNC	IK5000-VED-CNC	IK5000-VED-CNC



ViewMeasure

643 Series



Horizontal



Vertical



OPTICAL FEATURES

- Provides a quick solution to optically precisely measure small work pieces with multiple features
- The pattern recognition routines will allow the work piece to be randomly placed anywhere within the field of view
- Large field of view, long focal depth, minimal distortion
- Perspective and fluoroscopy error eliminated
- Quick measuring speed, multi task capability
- Easy Setup
- ASIMETO / M3 software optional
- Max work piece weight 2KG
- G Series

SPECIFICATIONS

Vertical

Code No.	643-11-0	643-11-1	643-11-2
Model	QVM 3040	QVM 3077	QVM 3095
Magnification	.133	.074	.059
Depth of field	3.8	12.4	19.2
Field of view (mm)	42x32	77x57	96x72
Z Axis travel	30	30	30
Accuracy (µm)	± 4.1+L/50	± 6.0+L/50	± 7.5+L/50
Camera	B/W , 5MP , Matrix		
Surface illumination	White Ring Light		
Contour illumination	Green Collimated Light		
W x L x H	290x222x618	290x222x700	330x245x750

Horizontal

Code No.	643-20-4	643-20-3	643-20-2	643-20-1
Model	QHM 3020	QHM 4030	QHM 6040	QHM 8060
Field of view (mm)	32x24	42x32	57x42	77x57
Accuracy (µm)	± 4.0+L/50	± 4.0+L/50	± 4.5+L/50	± 6.0+L/50
Camera	High resolution CCD			
Contour illumination	Green Collimated Light			

• Can be customized according to customer's requirements

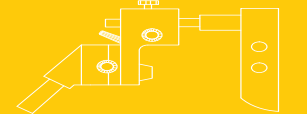

Concentricity Gauges

646 Series

FEATURES

- Precision structure with ball bearing slide
- equipped with Asimeto measuring tools or together with universal magnetic base
- light and easy to be used to measure concentricity / eccentricity for parts such as shaft, tube, bush, screw etc
- Dial test indicator and universal magnetic base are not included
- T Series



646-01-0

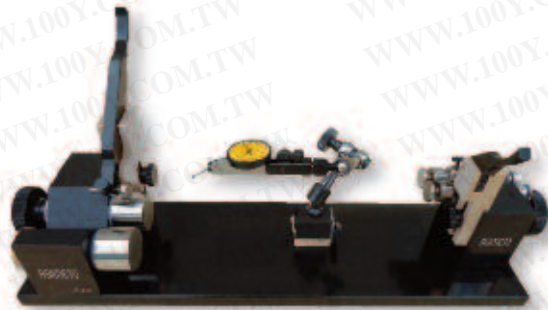

646-04-0

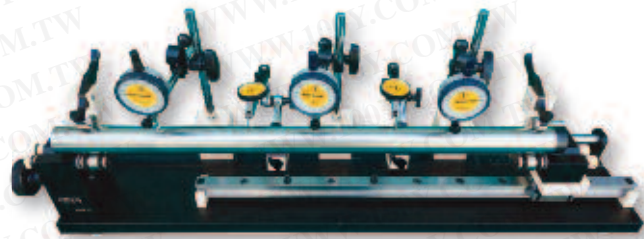

646-12-0

SPECIFICATIONS

Clip Outer Dia. (mm)	Size (mm)	Model	Code No.
Φ1 - Φ30	260 x 98 x 110	CMG-A	646-01-0
Φ1 - Φ30	260 x 170 x 150	CMG-AA	646-02-0
Φ30 - Φ90	330 x 140 x 95	CMG-AB	646-03-0
Φ1 - Φ90	520 x 140 x 200	CMG-ABA	646-04-0
Φ1 - Φ40	390 x 98 x 110	CMG-AL	646-05-0
Φ1 - Φ30	260 x 98 x 110	CMG-AR	646-06-0
Φ1 - Φ35	390 x 98 x 110	CMG-B1	646-07-0
Φ1 - Φ35	390 x 98 x 110	CMG-B1R	646-08-0
Φ1 - Φ35	500 x 98 x 120	CMG-B3	646-09-0
Φ1 - Φ35	500 x 98 x 120	CMG-B3R	646-10-0
Φ1 - Φ40	600 x 200 x 250	CMG-A-S3	646-11-0
Φ1 - Φ40	850 x 190 x 350	CMG-A-S6	646-12-0
Φ1 - Φ40	1250 x 190 x 350	CMG-A-S10	646-13-0



Vertical Profile Projectors

641 Series

FEATURES

- Used to inspect the profiles of a wide variety of parts and components
- Designed to provide an excellent quality image with accurate magnification
- The error of the contour measuring is under 0.08% deviation
- A convenient foot switch transfers the coordinate data to the data processing system
- Provides the data processing system and foot-switch, which are convenient to output and gather the data

STANDARD ACCESSORIES

- | | |
|--|-------|
| 1 Main body | 1 pcs |
| 2 Lens | 1 pcs |
| 3 Corresponding semi-reflective (Equipped With the Lens) | 1 pcs |
| 4 Spring Fixture of screen | 4 pcs |
| 5 2m Power wire | 1 pcs |
| 6 Instruction manual | 1 pcs |
| 7 Certification | 1 pcs |
| 8 Packaging list | 1 pcs |
| 9 4A/5 x 20 Fuse | 5 pcs |
| 10 24V 150W Halogen bulb | 2 pcs |



641-01-0

SPECIFICATIONS

Code No.		641-01-0 / 641-01-1			641-02-0 / 641-02-1		
Imaging direction		Obverse / Reverse Image			Obverse / Reverse Image		
Working Table	Stage Size (mm)	340 x 152			404 x 228		
	Glass Table Size (mm)	196 x 96			260 x 160		
	X-Axis Travel (mm)	150			200		
	Y-Axis Travel (mm)	50			100		
	Z-Axis Travel (mm)	90 (for focusing)			90 (for focusing)		
	Measuring Accuracy	4.0+L/25 Qm L: Measuring Length (mm)			4.0+L/25 Qm L: Measuring Length (mm)		
Resolution (X/Y-axis)		0.001 mm (1µm) or 0.0005 mm (0.5µm)			0.001 mm (1Qm) or 0.0005 mm (0.5µm)		
Projector Screen	Dimension	12" (Ø312 mm), usable range > Ø300 mm			12" (Ø312 mm), usable range > Ø300 mm		
	Rotary Range	0°-360°			0°-360°		
	Angle Resolution	1' or 0.01°			1' or 0.01°		
Objective Lens	Magnification	10X (Standard)	20X (Option)	50X (Option)	10X (Standard)	20X (Option)	50X (Option)
	Object View (mm)	Ø30	Ø15	Ø6	Ø30	Ø15	Ø6
	Working Distance (mm)	77.7	44.3	38.4	77.7	44.3	38.4
Data Processing System		DC-3000 multi-function data processing system: Coordinate skew, mm/inch conversion, ABS/INC conversion, Zero setting, calculation, 0°, 90°, 270°, 360° conversion, linear compensation					
Illumination		Transmission and reflection light source; 24V/150W-halogen lamp					
Power		110V/220V(AC), 50/60Hz, 400W total power					
Light Source Cooling		Forced air cooling					
Instruments dimension (mm)		770 x 550 x 1100			770 x 550 x 1100		
Weight (kgs)		130			160		
Option	Rotary Table		Code No.: 641-05-0				
	Swivel Center Support		Code No.: 641-05-1				
	Edge Detector		Code No.: 641-05-2				



Surface Roughness Tester 645 Series

FEATURES

- Portable, and simply operation
- Build-in Li-ion battery, can work independently
- Standard probe can be used on most of surface roughness applications, there are also optional probes can meet special measuring surface requirements
- Multi testing speed, including 0.5mm/s, 1.0mm/s
- Complies with many standrads including ISO, ANSI, DIN and JIS etc
- Diamond stylus tip, 90 tip degree angle and 5µm tip radius
- Detector measuring force less than 4mN

STANDARD ACCESSORIES

- Protective case
- Main unit, Battery Charger, Standard detector, Calibration specimen
- Front and rear height adjustment attachments, Protection shield, Screw driver
- Manual

SPECIFICATIONS

Part Number	645-02-0
Language	Chinese, Japanese and English
Measuring Range	160 µm
Detector travers	17.5 mm
Resolution	0.01µm on ± .20µm Range 0.02µm on ± .40µm Range 0.04µm on ± .80µm Range
Sampling Lengths	0.25,0.80,2.5 mm
L x W x H	140 x 52 x 48 mm
Weight	440 grams
Measurement Parameters	Ra,Rq,Rz,Rt,Rp,Rv,Rs,RSm, RSM(JIS),Ry(JIS),RSk,R3z,Rmax,Rpc,Rmr
Standards	ISO,ANSI,DIN,JIS
Filter	RC,PC-RC,Gauss,D-P
Accuracy	Less than or equal to 10% of reading
Repeatability	Less than or equal to 6% of reading
Power Supply	Built in Lithium Ion Battery with 6 Volt AC adapter



Surface Roughness Standards 506 Series

FEATURES

- Set of 30 specimens, 7/8" x 3/8" electro formed, solid nickel
- Used for the visual comparison of surface roughness

SPECIFICATIONS

Code No.	506-01-0	
Qty.	Contents	Roughness
2 pcs	Flat Lapping	0.05; 0.1µm (2; 4µ")
4 pcs	Reaming	0.2; 0.4; 0.8; 1.6µm (8; 16; 32; 63µ")
6 pcs	Grinding	0.05; 0.1; 0.2; 0.4; 0.8; 1.6µm (2; 4; 8; 16; 32; 63µ")
6 pcs	Horizontal Milling	0.4; 0.8; 1.6; 3.2; 6.3; 12.5µm (16; 32; 63; 125; 250; 500µ")
6 pcs	Vertical Milling	0.4; 0.8; 1.6; 3.2; 6.3; 12.5µm (16; 32; 63; 125; 250; 500µ")
6 pcs	Turning	0.4; 0.8; 1.6; 3.2; 6.3; 12.5µm (16; 32; 63; 125; 250; 500µ")





Digital Coating Thickness Gauges

506 Series



FEATURES

- Fast, non-destructive, precise measurement of various coating thicknesses and material thicknesses. Widely used in manufacturing where a coating has been applied to a base material or applications where the wall thickness requires measurement.
- The system incorporates magnetic and eddy current technologies for multipurpose measurements. By selecting the appropriate probe the thickness of the non-ferrous coatings on ferrous base metals or non-ferrous coatings on non-ferrous metal substrates.
- Data storage capacity of 20 groups of 50 actual measured values.
- Metric / Inch conversion
- Working voltage: 3V (2, 5 alkaline batteries).
- Two individual probe calibration methods are supported. calibration compensation of system error increases the measurement accuracy.
- Measuring status indicator displays the measuring status and type of measurement.
- Measured values and user information are shown on a large, easy-to-read LCD. a back lit display ensures easy reading of the data in poorly-lit environments.
- Battery level indicator provides the remaining battery voltage.
- Auto sleep and auto power off functions increases battery life.
- Compact Aluminum case provides storage protection.

STANDARD ACCESSORIES

- Probe 1 pcs
- Calibration Foils 5 pcs
- Zero plate 1 pcs
- Manual 1 pcs
- Alkaline Battery 2 pcs

SPECIFICATIONS

Range	Resolution	Probes	Remark	Code No.
0-1250 μm	0.1 μm	N1	For measuring thickness of non-conductive coating on non-magnetic metal substrate	506-10-0
0-1250 μm	0.1 μm	F1	For measuring thickness of non-magnetic coating on magnetic metal substrate	506-10-1
0-10000 μm	0.1 μm	F10	For measuring thickness of non-magnetic coating on magnetic metal substrate	506-10-3

Shore Scale A Durometer

640 Series



FEATURES

- Used for precisely determining the Shore hardness value of rubber & plastic materials

SPECIFICATIONS

Code No.	640-06-0
Range	20-90HA
Test Force	0.55-8.06N (56-82 lgf)
Dimension	110 x 58 x 30mm
Weight	Approx. 500g



Rockwell Type Hardness Testers

640 Series

FEATURES

- For testing the hardness of various materials to determine the Rockwell hardness to scales A, B and C
- Unit is designed with mechanical loads for precise hardness readings
- Conform to the requirements of ASTM E18, ISO 6508-2 and GB/T 230.2 standards
- Readings provided to a minimum resolution 0.5HR

STANDARD ACCESSORIES

- Diamond cone penetrator 1 pcs
- V-notch anvil 1 pcs
- Small flat anvil 1 pcs
- Large flat anvil 1 pcs
- Rockwell standard 5 pcs
- 1/16" steel ball penetrator 1 pcs
- Instruction manual 1 pcs



640-01-0



640-02-0

SPECIFICATIONS

Range	Test Force	Test Height	Throat Depth	Code No.
20-88HRA, 20-100HRB, 20-70HRC	588.4, 980.7, 1471N (60, 100, 150kgf)	170mm	135mm	640-01-0
20-88HRA, 20-100HRB, 20-70HRC	588.4, 980.7, 1471N (60, 100, 150kgf)	400mm	160mm	640-02-0

Digital Twin Rockwell Hardness Tester

640 Series

FEATURES

- Twin tester--Regular Rockwell & Rockwell Superficial hardness for metal and plastic material
- Horizontal protrudent indenter design, also suitable for internal and external testing
- Testing on surfaces difficult to reach. Testing internal surface of rings and tubes with diameters over 23mm
- Testing force is set automatically according to testing scale
- Provided with many features such as high measuring precision, wide measuring range with 30 Rockwell scales
- Measuring results are digitally displayed and can be printed, or transmitted to external computer automatically by USB or RS-232 cable
- Test value can be transformed to the value of HB, HV, HK and σ_b value
- The tester meets all the following standard such as ISO 6508-2, ASTM E18



Rockwell Scales	Test Force	Resolution	Test Height	Throat Depth	Code No.
HRA, HRB, HRC, HRD, HRE, HRF, HRG, HRH, HRK, HRL, HRM, HRP, HRR, HRS, HRV	147.1, 294.3, 441.3N (15, 30, 45kgf)	0.1HR	260mm	150mm	640-20-3



Touch Screen Rockwell Type Hardness Testers

640 Series

FEATURES

- Half automatic hardness tester except loading initial force and change force knob, Operation is very convenient and fast
- Color touch screen, displays loading force, indenter type, dwell time, and conversion scale
- Auto hardness conversion to others scales, no need to check table and improve working efficiency
- Support Multiple languages, English, Turkish, German, etc. Convenient for local customers operation
- Optional blue tooth mini printer is available

SPECIFICATIONS

Range	Test Force	Test Height	Code No.
20-88HRA, 20-100HRB, 20-70HRC	588.4, 980.7, 1471N (60, 100, 150kgf)	175mm	640-01-1



640-01-1

Brinell Hardness Testers

640 Series

FEATURES

- Used for determining the Brinell hardness of various metals
- A "V" anvil is supplied for testing round work pieces
- Readings provided to a minimum resolution 0.5HR
- Mechanical models are designed with reversing switch
- Digital Models provide automatic operation reducing manual testing errors
- The digital model has a large LCD screen

STANDARD ACCESSORIES

- | | |
|--|------------|
| 1, Tungsten carbide ball penetrator
Ø2.5mm, Ø5mm, Ø10mm | 1 pcs each |
| 2, V-notch anvil | 1 pcs |
| 3, Small flat anvil | 1 pcs |
| 4, Large flat anvil | 1 pcs |
| 5, Brinell standardized block | 2 pcs |
| 6, 20X readout microscope | 1 pcs |
| 7, Instruction manual | 1 pcs |



640-10-1

SPECIFICATIONS

Code No.	640-10-1	640-10-7	640-10-6
	Mechanical models	Digital models	Digital models
Range	8-650HBW	8-650HBW	4-650HBW
Test Force	1838.8, 2451.8, 7355.3, 9807, 29421N (187.5, 250, 750, 1000, 3000kgf)	980.7, 1225.9, 1838.8, 2451.8, 4903.5, 7355.3, 9807, 14710.5, 29421N (100, 125, 187.5, 250, 500, 750, 1000, 1500, 1500, 3000kgf)	1838.8, 2451.8, 4903.5, 7355.3, 9807, 29421N (62.5, 100, 125, 187.5, 250, 500, 750, 1000, 1500, 1500, 3000kgf)
Max. height of test piece	230mm	280mm	240mm
Depth of throat	120mm	150mm	150mm
Power Supply	380V AC or 220V AC. 50 or 60 Hz	220V AC or 110V AC. 50 or 60 Hz	220V AC or 110V AC. 50 or 60 Hz
Dimension	700 x 268 x 842mm	570 x 330 x 910mm	570 x 330 x 910mm
Weight	Approx. 210kg	Approx. 290kg	Approx. 350kg



Impact Hardness Testers

640 Series

FEATURES

- Large screen (128×64 dot matrix LCD), allows for clear display of all functions and parameters
- Hardness test can be taken at any angle including inverted.
- A wide measuring range supports the hardness of all metallic materials. Hardness results are directly displayed in HRB, HRC, HV, HB, HS, HL hardness scales.
- Six impact devices are available for special application with automatic impact device recognition.
- Diameter of carbide ball: 3mm.
- Large capacity memory storage of 500 sub groups. Stored information including single measured value, mean value, test data, impact direction, impact times, material and hardness scale are available.
- Five languages are supported with 640-17-X series: English, French, German, Italian and Spanish; 640-16-X series are Chinese display.
- Upper and lower limit can be preset. An audio alarm will automatically sound when the reading is outside of the preset limits.
- Battery voltage information is displayed including the charge status.
- Calibration function is available.
- USB1.1 port allows for information to be uploaded directly to a pc.
- High speed thermal printer allows for the readings to be immediately printed.
- 6V Ni-MH rechargeable battery are supplied. The batteries can be charged with the integrated charger. Up to 150 hours of continuous operation battery life between charges. (eL off and no printing)
- Automatic power off after five minutes.



STANDARD ACCESSORIES

- Impact device 1 pcs
- Hardness test block 1 pcs
- Small support ring 1 pcs
- Cleaning brush 1 pcs
- Battery Charger 1 pcs
- Paper for printing 1 pcs
- Manual 1 pcs
- DataPro software 1 pcs
- Communication cable 1 pcs

SPECIFICATIONS

Range	Accuracy	Application Range	Impact devices	Impact Capacity	Code No.	
					Chinese	ENG/FRA/GER/ITA/SPA
(170-960) HLD (17-68.5) HRC (19-651) HB	HLD: ±5 HRC: ±1 HB: ±4	Test the normal smooth , flat surface	D	11 Nmm	640-16-1	640-17-1
		Test hole or hollow cylindrical	DC	11 Nmm	640-16-2	640-17-2
		Test small ,light,thin parts and surface of hardened layer	C	2.7 Nmm	640-16-3	640-17-3
		Test groove or re-entrant surface	D+15	11 Nmm	640-16-4	640-17-4
		Test slender narrow groove or hole	DL	11 Nmm	640-16-5	640-17-5
		Test large,thick,heavy and rough surface steel	G	90 Nmm	640-16-6	640-17-6

Hardness Test Blocks

640 Series

SPECIFICATIONS

Description	Range of Hardness	Dimension	Weight	Code No.
Brinell standardized Block	200 ± 50 HBS 100 ± 25 HBS	100 X 80 X 16mm	1kg	640-80-0
Rockwell standardized Block	80 - 88 HRA 85 - 95 HRB 20 - 30 HRC 35 - 55 HRC 60 - 70 HRC	60 X 40 X 10mm	0.19kg	640-81-0
Leeb standardized Block	790 ± 40 HLD	Ø90 X 55mm	2.7kg	640-82-0



Hardness Tester Penetrators

640 Series

SPECIFICATIONS

Description	Specification	Code No.
Penetrator for Rockwell Hardness Tester	120° Diamond cone penetrator Ø1.588mm (1/16") steel ball penetrator	640-83-0
Penetrator for Brinell Hardness Tester	Ø2.5, 5, 10mm Tungsten carbide ball penetrator	640-84-0





Microscope XC-100L



642-01-0

FEATURES

- Sharp stereo erect image over a wide field of view. It is suitable for spot examination of machinery industry, paper making, print and textile, etc. The product features small size, light weight, nice design and easy operation

STANDARD ACCESSORIES

- Eyepiece, Lamp, Instruction manual

Code No.	642-01-0	
Graduation	0.01mm	
Magnification	100X	
Field of View	18mm	
Working Distance	6.93mm	
Eyepiece	WF10X, Graduation: 0.025 mm	
Objective	10X	
Illumination System	Pen Illumination	
Spare Part	Description	Code No.
Objective	4X	642-10-0

Microscope MS-2



642-01-1

FEATURES

- Sharp stereo erect image over a wide field of view
- Rotatable objective, 45° inclined and 360° rotatable

STANDARD ACCESSORIES

- Eyepiece, Glass stage, Instruction manual

Code No.	642-01-1	
Magnification	20X	
Field of View	8.5mm	
Working Distance	80mm	
Eyepiece	WF10X / 20mm	
Objective	2X	
Illumination System	N/A	
Spare Part	Description	Code No.
Eyepiece	WF16X	642-10-1
Eyepiece	WF10X, Graduation: 0.025 mm	642-10-2

Stereo-Microscope ST 40



642-01-2

FEATURES

- Sharp stereo erect image over a wide field of view
- Binocular Tube. 45° inclined binocular head with locked-in eyepiece. The left ocular-tube with diopter adjustment $\pm 5dp$, The interpupillary distance is between 55-75mm
- Pillar style stand

STANDARD ACCESSORIES :

- Eyepiece 1 pair, Eyepiece cover 1 pair, Lamp, Glass stage, Power wire, Instruction manual

Code No.	642-01-2	
Magnification	20X / 40X	
Field of View	10mm / 5mm	
Working Distance	76mm	
Eyepiece	WF10X	
Objective	2X / 4X	
Illumination System	12V / 10W double-lighting	



Stereo-Microscope ST 45



642-01-3

FEATURES

- Sharp stereo erect image over a wide field of view
- Binocular Tube. 45° inclined binocular head with locked-in eyepiece. The left ocular-tube with diopter adjustment $\pm 5dp$, The interpupillary distance is between 55-75mm
- Arm curved style stand

STANDARD ACCESSORIES

- Eyepiece 1 pair, Eyepiece cover 1 pair, Lamp, Glass stage, Power wire, Instruction manual

Code No.	642-01-3
Magnification	20X / 40X
Field of View	10mm / 5mm
Working Distance	76mm
Eyepiece	WF10X / 20mm
Objective	2X / 4X
Illumination System	12V / 10W Halogen and Incandescent

Stereo-Microscope ST 50



642-01-4

FEATURES

- Sharp stereo erect image over a wide field of view
- Dovetail inserted style objective with locked-in device ensures easy replacement
- With adjustable arm, which provides a wider field of view higher; could provide a larger working distance

STANDARD ACCESSORIES

- Eyepiece 1 pair, Eyepiece cover 1 pair, lamp, power wire, Instruction manual

Code No.	642-01-4
Magnification	20X
Field of View	10mm
Working Distance	230mm
Eyepiece	WF10X / 20mm
Objective	2X
Illumination System	12V / 10W Incandescent

Accessory for ST 40/ST 45

Spare Part	Description	Code No.
Eyepiece	WF15X / 15mm	642-10-3
Eyepiece	WF20X / 10mm	642-10-4
Eyepiece	WF10X , Graduation: 0.05 mm	642-10-5



Stereo-Microscope LAB 1

FEATURES

- Sharp stereo image over a wide field of view
- 90° rotational objective, Binocular Tube: 360°rotating and 45°inclined
- Pillar style stand



642-01-5

STANDARD ACCESSORIES

- Eyepiece 1 pair, Eyepiece cover 1 pair, Lamp, Glass stage, Power wire, Instruction manual

Code No.		642-01-5
Magnification	20X / 40X	
Field of View	10mm / 5mm	
Working Distance	99mm / 81mm	
Eyepiece	WF10X	
Objective	2X / 4X	
Illumination System	12V / 10W Adjustable double-lighting	
Spare Part	Description	Code No.
Eyepiece	WF15X / 15mm	642-10-3
Eyepiece	WF20X / 10mm	642-10-4
Eyepiece	WF10X (1 pc), Graduation: 0.05 mm	642-10-5

Stereo-Zoom Microscope LAB 2

FEATURES

- Sharp stereo image over a wide field of view
- Binocular Tube: 360°rotating and 45°inclined
- Pillar style stand



642-01-6

STANDARD ACCESSORIES

- Eyepiece 1 pair, Eyepiece cover 1 pair, Lamp, Glass stage, Power wire, Instruction manual

Code No.		642-01-6
Magnification	10X-40X	
Field of View	23mm - 5.5mm	
Working Distance	91mm	
Eyepiece	SWF10X	
Objective	1X-4X	
Illumination System	12V / 10W Adjustable double-lighting	
Spare Part	Description	Code No.
Eyepiece	WF15X / 15mm	642-10-3
Eyepiece	WF20X / 10mm	642-10-4
Eyepiece	WF10X, Graduation: 0.05 mm	642-10-5
Auxiliary objective	2X	642-11-3



Accessories for SZM1, SZM2, SZM3, SZM4



642-11-5

Spare Part	Description	Code No.
Eyepiece	WF15X / 15 mm	642-10-7
Eyepiece	WF20X / 10 mm	642-10-8
Eyepiece	WF10X, Graduation: 10 mm / 0.1mm	642-10-9
Adoption Lens	0.5X	642-11-0
Adoption Lens	2.0X	642-11-1
CCD - Camera	1.3 million pixels	642-11-5
Adapter (c-mount)	1 X	642-12-2
Adapter (c-mount)	1/2 X	642-12-0
Auxiliary objective	2X	642-11-2

LED Ring Lights

FEATURES

- For illumination of workpieces
- Model #642-20-2 is solid one piece design. with control box inside . LED lights can be divided into 4 segments
- Model #642-20-1 comes with a separate control box, LED light is adjustable



Back



Front

642-20-2



Control box

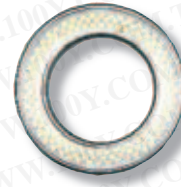

Front

642-20-1

Dimension	Segments	Code No.
Ø60mm	1	642-20-1
Ø60mm	4	642-20-2

勝特力材料 886-3-5753170
 勝特力电子(上海) 86-21-34970699
 勝特力电子(深圳) 86-755-83298787
[Http://www.100y.com.tw](http://www.100y.com.tw)