

產品名稱/產品號

Circuits

Dim. A

Housing
6350F0302

3

20.32

產品備註:

UL File No. : E 159426

CSA File No. : LR 102762

規格說明:

Current Rating : 10A AC,DC(AWG 14)

Voltage Rating : 600V AC,DC

Withstand Voltage : 5000V AC/Minute

Contact Resistance : 10mΩ Max.

Insulation Resistance : 1000MΩ Min.

Temperature Range : -55°C to +105°C

Applicable PC Board Thickness : 1.6mm

勝特力材料 886-3-5753170

勝特力电子(上海) 86-21-54151736

勝特力电子(深圳) 86-755-83298787

[Http://www.100y.com.tw](http://www.100y.com.tw)

大圖示

ASSEMBLY LAYOUT

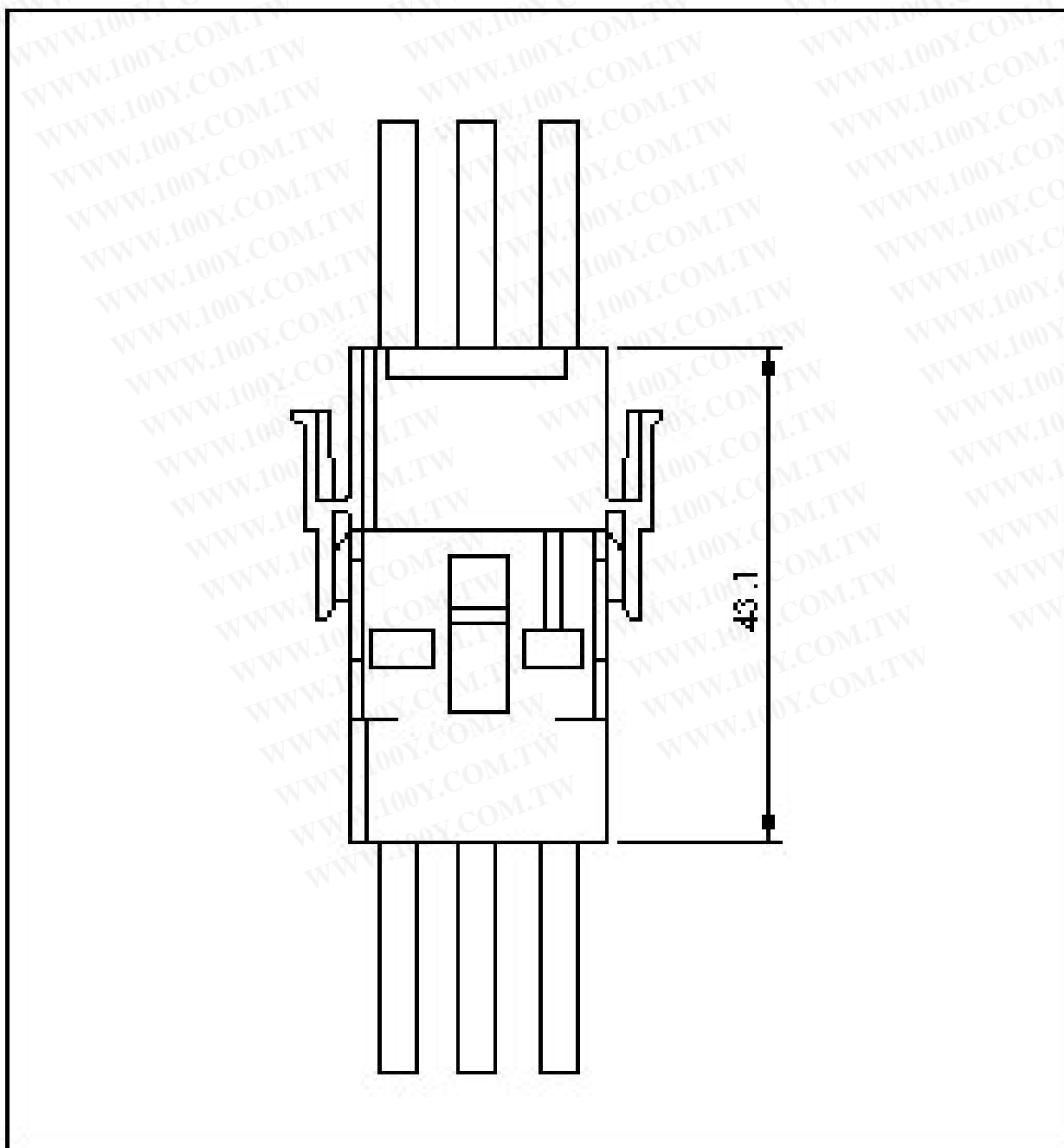

小圖示

2, 3, 4 Circuit (In-Line)

PC Board Layout

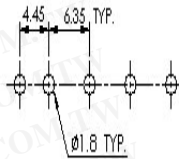

6 Circuit (Matrix)

PC Board Layout

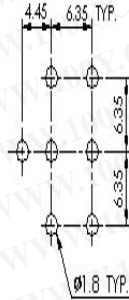

9, 12, 15 Circuit (Matrix)

PC Board Layout

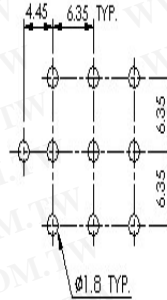

勝特力材料 886-3-5753170
勝特力电子(上海) 86-21-54151736
勝特力电子(深圳) 86-755-83298787
[Http://www.100y.com.tw](http://www.100y.com.tw)

2, 3, 4 Circuit (In-Line)

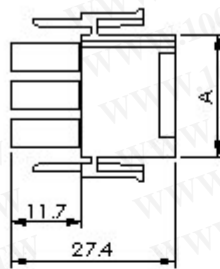

6 Circuit (Matrix)

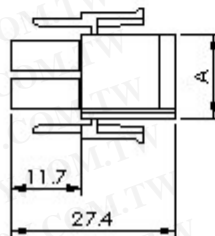
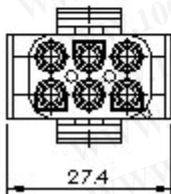

9, 12, 15 Circuit (Matrix)

