



Timer/Counter/Tachometer *User Manual*

勝特力材料 886-3-5753170
勝特力电子(上海) 86-21-34970699
勝特力电子(深圳) 86-755-83298787
[Http://www.100y.com.tw](http://www.100y.com.tw)



FORWARD

This user manual provides handy instructions for the operation of Delta CTA series. The detailed operational instructions help the user to easily locate the functions they would like to acquire. In addition, this user manual also helps sales and engineering staff to understand more about the advantages of Delta CTA series and assist the users to operate CTA as well as getting familiar with its functions. The date of the latest update is shown in the bottom left of the page.

CHAPTER ONE: BASIC INSTRUCTIONS

1.1 Features.....	4
1.2 Ordering Information	4
1.3 Specifications.....	4
1.4 Display, Indicators & Keys	5
1.5 Dimensions	5
1.6 Terminals Definition	5
1.7 Default Settings.....	7
1.8 Easy DIP Switch Setup.....	7

CHAPTER TWO: FUNCTIONS

2.1 Timer.....	9
2.2 Counter.....	14
2.3 Tachometer.....	19
2.4 Timer + Counter (Mixed Mode).....	22

CHAPTER THREE: APPLICATIONS

3.1 On Cut-To-Length Machine.....	23
-----------------------------------	----

NOTES

How to use CTA correctly...

- To avoid misaction caused by interference, please make sure if you isolate the I/O wiring when I/O wiring and power cable or high-voltage cable in the same wiring tube. If possible, use a separate tube for the I/O wiring.
- Make sure that you place the sensor, other input devices, signal cables and CTA away from the interference source.
- It will require 200ms after CTA is switched on for the activation of the internal power and default value reset. CTA may not operate normally during this period of time.

CHAPTER ONE: BASIC INSTRUCTIONS

1.1 Features

Delta CTA series is the 3-in-1 timer, counter and tachometer with the following features:

- Can be a timer, counter, or tachometer and can operate in timer + counter mixed mode.
- Offers voltage input (PNP) or non-voltage input (NPN).
- The Pre-Scale function allows the input pulses to be displayed in their actual units.
- Counting speeds available: 1/30/200/1K/5K/10K cps. Maximum: 10K cps.
- The counting can be conducted in millisecond, second, minute, minute/second and hour/minute/second.
- Output 1 contains relay output and transistor output. The two types of outputs can be enabled concurrently.
- Offers total counting and batch counting.
- "Reset" and "Lock" keys for more convenient use.
- Offers 6-digit double-line LCD display.
- Offers easy DIP switch setup.
- Decimal point setup available.

1.2 Ordering Information

There are currently two model types available: CTA4000A and CTA4100A, only differentiating in the type of output 2.

CTA4□00A
1 2 3 4 5

CTA: Delta Timer/Counter/Tachometer A series

❶ Panel size	4: 48mm × 48mm
❷ Output 2	0: Transistor 1: Relay
❸ Preset stage	0: 2 preset stage
❹ Communication	0: None
❺ Power supply	A: AC100 ~ 240V

1.3 Specifications

Power input	AC100 ~ 240V, 50/60Hz
Input voltage range	85% to 110%, rated voltage
Power consumption	Less than 10VA
External power supply	12Vdc ±10%, 100mA
Display	Double-line, 6-digit LCD display
Input signal	Non-voltage input (NPN): ON impedance 1K ohm max. ON residual voltage: 2V max. Voltage input (PNP): High level: 4.5 to 30Vdc, Low level: 0 to 2Vdc
Output 1	Relay: SPST max.250Vac, 5A (resistance load) Transistor: NPN open collector. When 100mA /30Vdc, residual voltage = 1.5Vdc max.
Output 2	Relay: SPDT max.250Vac, 5A (resistance load) Transistor: NPN open collector. When 100mA /30Vdc, residual voltage = 1.5Vdc max.
Dielectric strength	2000Vac 50/60 Hz for 1 minute
Vibration resistance	Without damage: 10 ~ 55Hz, amplitude = 0.75mm, 3 axes for 2 hours
Shock resistance	Without damage: drop 4 times, 300m/s ² , 3 edges, 6 surfaces and 1 corner
Ambient temperature	0°C to +50°C
Storage temperature	-20°C to +65°C
Altitude	2000m or less
Ambient humidity	35% to 85% RH (non-condensing)
Pollution degree	Degree 2

1.4 Display, Indicators & Keys

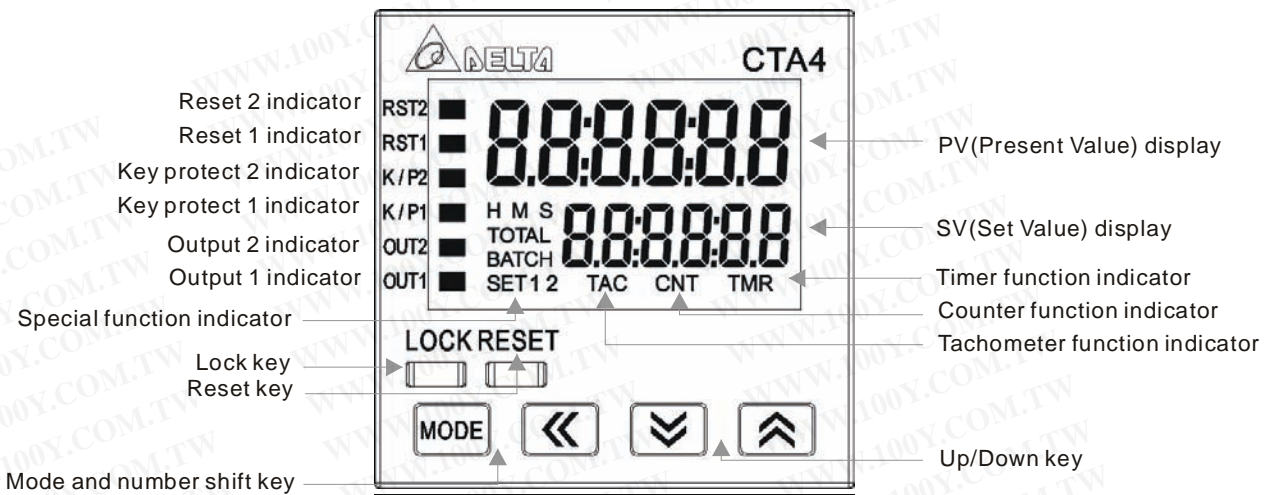

- PV: Red LCD
- SV and other display areas: Green LCD
- H M S: Time unit for the timer
- TOTAL: Total counting value
- BATCH: Batch counting value
- SET1 2: SV1 and SV2

1.5 Dimensions

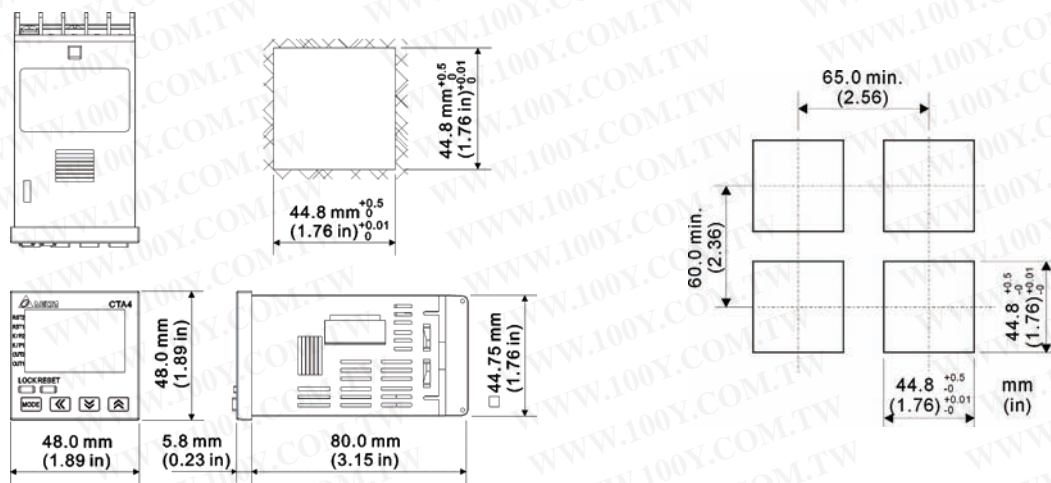

1.6 Terminal Definition

CTA combines the functions of timer, counter and tachometer; therefore, the definitions of input terminals in different modes are slightly different. CTA has 4 terminals ready for inputs. Take the pins in counter mode for example, ⑫⑬⑦⑧ are for CP1 (A phase), CP2 (B phase) RST1 and RST2 inputs (see figure 1).

The output terminals are for OUT1 and OUT2. OUT1 has two outputs, transistor output and relay output, and the two outputs operate concurrently. The type of OUT2 is determined by the model name. For CTA4000A, OUT2 only offers transistor output with inductive load protection diode (see figure 2). For CTA4100A, OUT2 only offers relay output (see figure 3).

CTA4 series

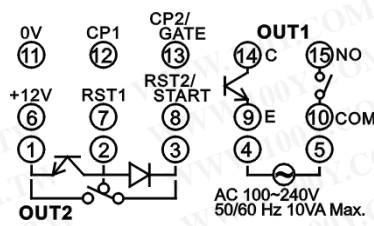

Counter	Timer	Tachometer	Timer + Counter
CP1		CP1	CP1
CP2	Gate		Gate
Reset1	Reset1	Reset1	Reset1
Reset2	Start		Start

Figure 1

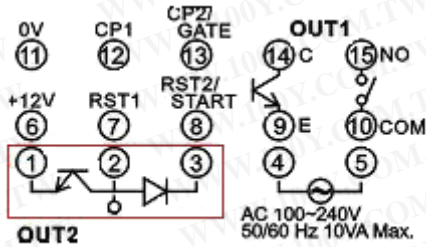

Figure 2

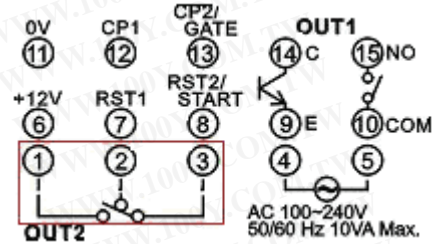
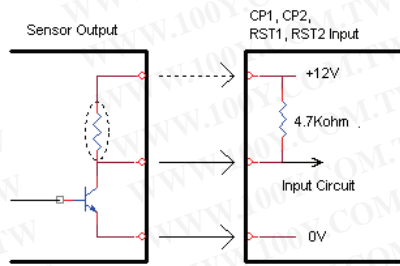

Figure 3

Input connection:

NPN



NPN Input Logic

PNP

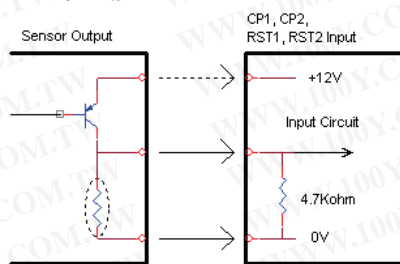

PNP Input Logic

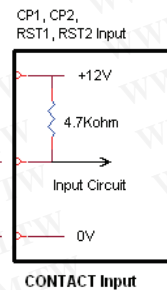

CONTACT Input

Output load PIN connection:

1. When CP1, CP2, RST1 and RST2 inputs are contact inputs, please set the input type as NPN.
2. When the previous device is an open collector type, the device can adopt the 12V power supply offered by CTA for the connection.

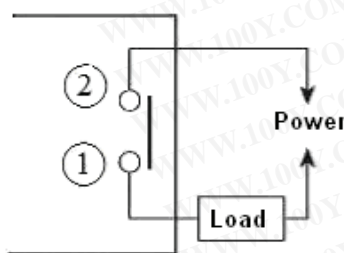

(Relay Output)

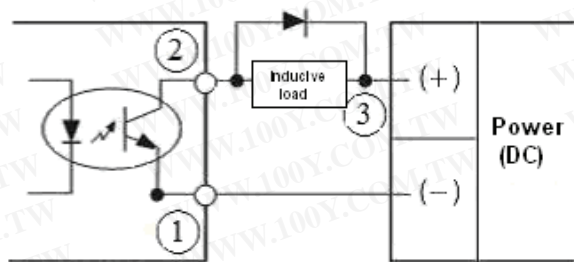

(Transistor Output)

1.7 Default Settings

There are 4 operation modes in CTA: timer, counter, tachometer and timer + counter. The table below offers the preset parameters for all functions.

Function		Preset setting	Function		Preset setting
Timer	Select function	Timer	Tachometer	Select function	Tachometer
	Timer mode	Up (counting up)		Output mode	2Lo1Lo
	Output mode	Sond1		Counting speed	5K
	Displayed unit	S 001 (0.01)		Position of decimal point	0 (no decimals)
	Pulse width of output 1	0.02sec		Pre-scale value	1.000 (default)
	Min. width of reset signal	20ms		Delay time while switching on power	0.0 (no delay)
	Input signal type	NPN		Average of input data	0 (function disabled)
Counter	Select function	Counter	Tachometer	Min. width of reset signal	20ms
	Counter mode	Stage1 (1 stage)		Input signal type	NPN
	Input mode	Up (counting up)		Select function	Mix (Timer +Counter)
	Output mode	F	Input mode of timer	Up (counting up)	
	Counting speed	5K	Output mode of timer	Sond1	
	Position of decimal point	0 (no decimals)	Displayed unit of timer	S 001 (0.01)	
	Pre-scale value	1.000	Input mode of counter	Up (counting up)	
	Save data while switching off power	Clear	Output mode of counter	F	
	Min. width of reset signal	20ms	Timer + Counter	Counting speed	5K
Input signal type	NPN	Pulse width of output 1		0.02sec	
		Position of decimal point		0 (no decimals)	
		Pre-scale value		1.000 (default)	
		Save data while switching off power		Clear	
		Min. width of reset signal		20ms	
		Input signal type		NPN	

1.8 Easy DIP Switch Setup

The tables below are the DIP switches for each mode of CTA. Please be noted that in the "timer + counter" mode, setting up parameters by DIP switches are not allowed.

■ Timer

Switch	Function	OFF	ON
1	DIP switch	Disabled	Enabled
2	Timer mode	Counting up	Counting down
3	Output mode	See top-right table	
4			
5	Displayed unit	See bottom-right table	
6			
7			
8	Width of reset signal	20ms	1ms

Switch 3	Switch 4	Output mode
OFF	OFF	Sond1
ON	OFF	Sond2
OFF	ON	Soffd
ON	ON	Son

Switch 5	Switch 6	Switch 7	Displayed unit
OFF	OFF	OFF	0.01 sec.
ON	OFF	OFF	0.1 sec.
OFF	ON	OFF	1 sec.
ON	ON	OFF	min., 0.01 sec.
OFF	OFF	ON	min., 0.1 sec.
ON	OFF	ON	0.1 min.
OFF	ON	ON	minute
ON	ON	ON	hr., min., sec.

■ Counter

Switch	Function	OFF	ON
1	DIP switch	Disabled	Enabled
2	Counting mode	Counting up	Counting down
3	Output mode	See the table on the right	
4			
5	Counting speed	30cps	10Kcps
6	Reserved	-	-
7	Input signal	NPN	PNP
8	Width of reset signal	20ms	1ms

Switch 3	Switch 4	Output mode
OFF	OFF	F
ON	OFF	N
OFF	ON	C
ON	ON	R

■ Tachometer

Switch	Function	OFF	ON
1	DIP switch	Disabled	Enabled
2	Reserved	-	-
3	Output mode	See the table on the right	
4			
5	Counting speed	30Hz	10KHz
6	Reserved	-	-
7	Input signal	NPN	PNP
8	Width of reset signal	20ms	1ms

Switch 3	Switch 4	Output mode
OFF	OFF	Lo-Lo
ON	OFF	Lo-Hi
OFF	ON	Hi-Lo
ON	ON	Hi-Hi

※When Switch 1 is enabled (ON), the parameters can only be set up by Switch 1 ~ Switch 8 and cannot be modified in the system. If the parameters have to be set in the system, please disable Switch 1 (OFF).

CHAPTER TWO: FUNCTIONS

2.1 Timer

There are counting up and counting down modes in the timer.

2.1.1 Setting up the counting unit

	sec.	0.01 ~ 9,999.99	A unit = 10ms	Max. counting = 9,999.99 secs.
	sec.	0.1 ~ 99,999.9	A unit = 0.1 sec.	Max. counting = 99,999.9 secs.
	sec.	1 ~ 999,999	A unit = 1 sec.	Max. counting = 999,999 secs.
	min., sec.	0.01 ~ 9,959.99	A unit = 0.01 sec.	Max. counting = 5,999.99 secs.
	min., sec.	0.1 ~ 99,959.9	A unit = 0.1 sec.	Max. counting = 59,999.9 secs.
	min.	0.1 ~ 99,999.9	A unit = 0.1 min.	Max. counting = 99,999.9 mins.
	min.	1 ~ 999,999	A unit = 1 min.	Max. counting = 999,999 mins.
	hr., min., sec.	1 ~ 995,959	A unit = 1 sec.	Max. counting = 359,999 secs. (100 hrs.)
	hr., min.	1 ~ 999,959	A unit = 1 min.	Max. counting = 35,999,999 secs. (10,000 hrs.)
	hr.	1 ~ 999,999	A unit = 1 hr.	Max. counting = 699,999 hrs.

2.1.2 Setting up the parameters in the timer

To enter the page for parameter setting of the timer, press **MODE** in the main menu for more than 3 seconds. After the setup is completed, press **MODE** for more than 3 seconds under any of the parameter page you are in and return to the main menu.

→ → → →

MODE ↓ Select functions: There are 4 modes in CTA, (left to right) timer, counter, tachometer and timer + counter.

→ →

MODE ↓ Select timer mode: counting up and counting down

→ → → → → →

MODE → → → → → →

↓ Select output modes: There are 12 output modes in the timer. The user can choose the mode that best meets the demand. See 2.1.3 for more details.

→ → → → → →

MODE → → → →

↓ Select display unit: the min. unit 10ms ~ the max. unit hour are selectable

→ →

MODE Select pulse width of output 1: The default output time is 0.02 second. When the parameter is set to 0.00 second, the output status will continue.

↓

→ →

MODE ↓ Select min. width of reset signal: The default value is 20ms; can be set to 1ms.

→ →

MODE ↓ Select input signal types: NPN and PNP

Back to Top

2.1.3 Setting up output mode of the timer

There are 12 modes in the timer for different control demands from the user. The default output time of the 12 modes is 0.02 second. If you wish the system to keep the operation of the output, please set the output time to 0.00 second.

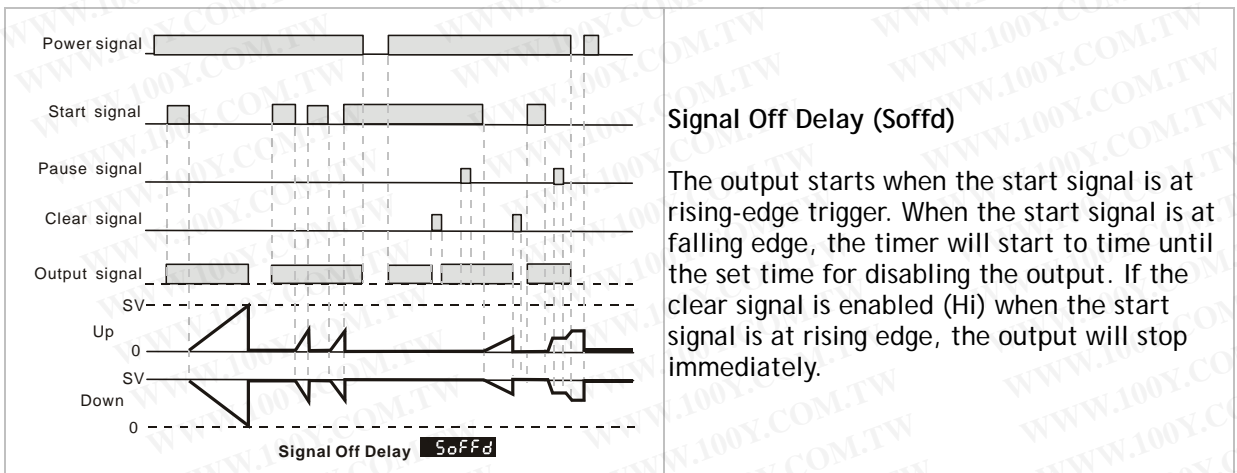
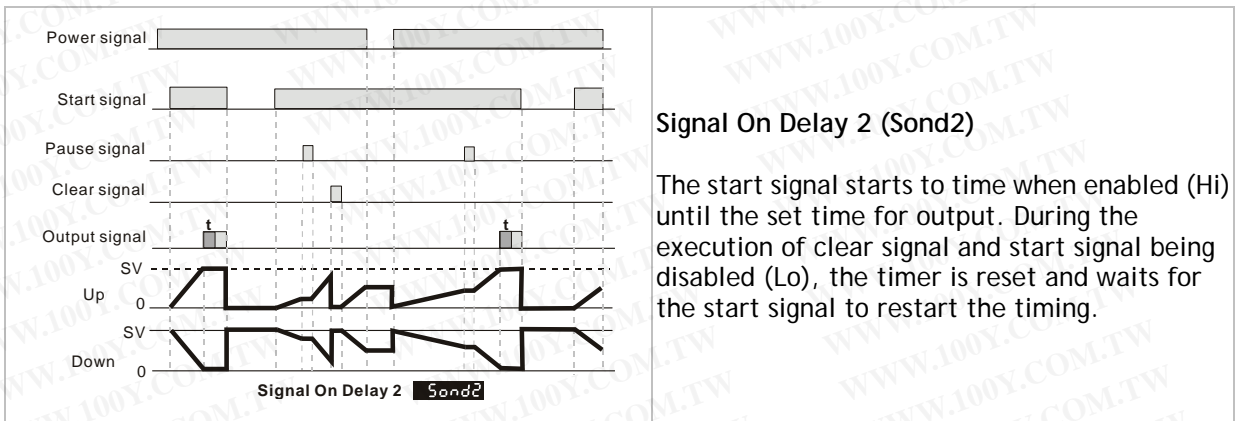
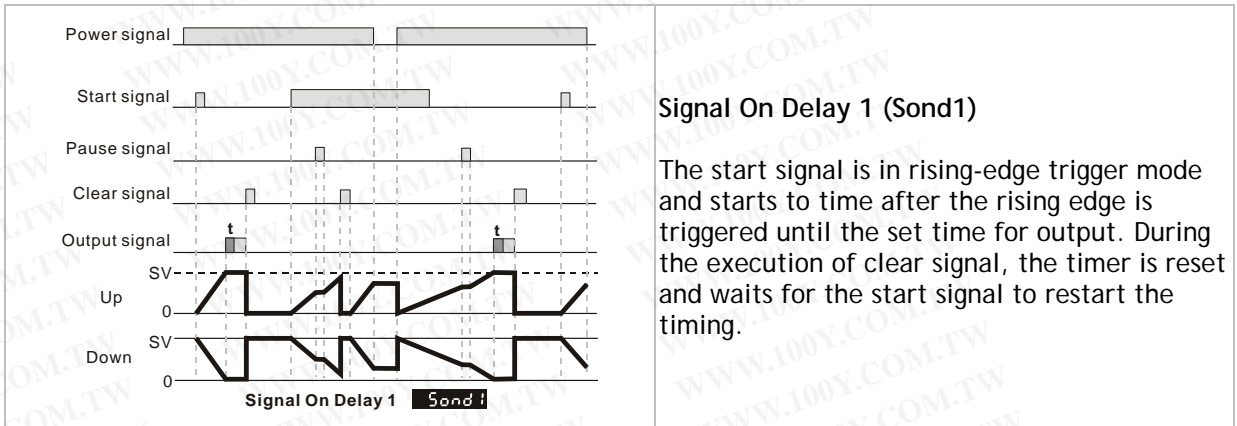

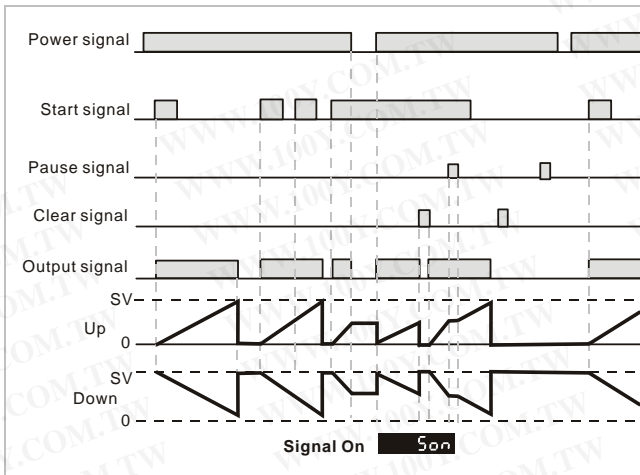

Signal On (Son)

The start signal starts to time and output when the rising edge is triggered and the clear signal is not executed. When the set time is reached, the timer will return to the default value and the output will be disabled.

If clear signal is received during the execution of the timer, the timer will return to the default value and the output will stop.

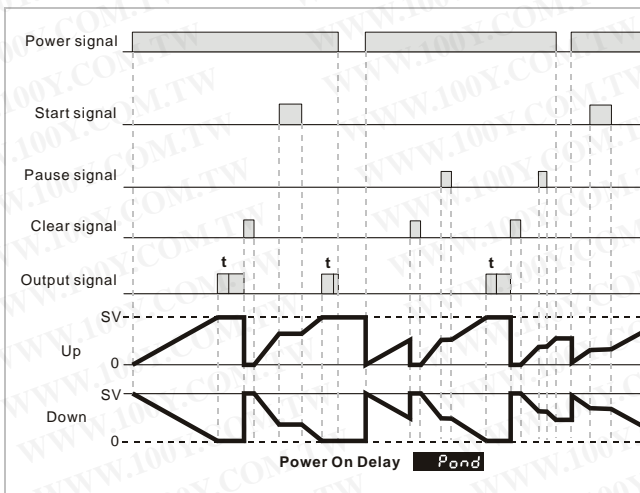

Power On Delay (Pond)

CTA immediately starts to time after the power is switched on. During the timing, the start signal and pause signal are able to stop the timing. When the set time is reached, the output will be enabled and the timing will stop.

When the clear signal is executed, the timing will be reset until the execution of clear signal is completed and the timing will start again.

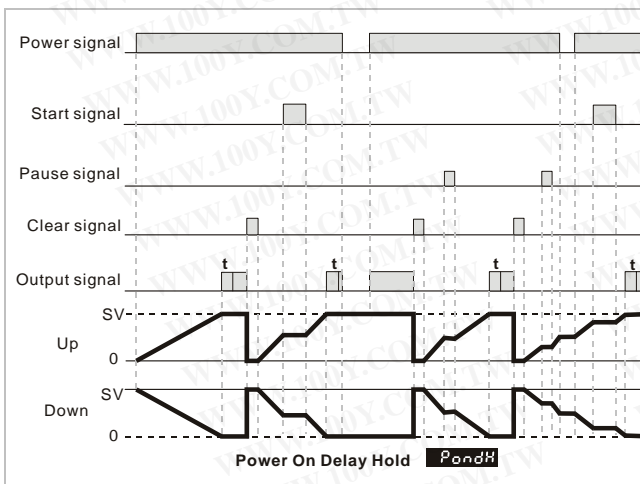

Power On Delay Hold (PondH)

Same as "Pond"

The only difference is whether the current value is held when the power is switched off. In PondH, After the power is switched on, the timer will resume the timing.

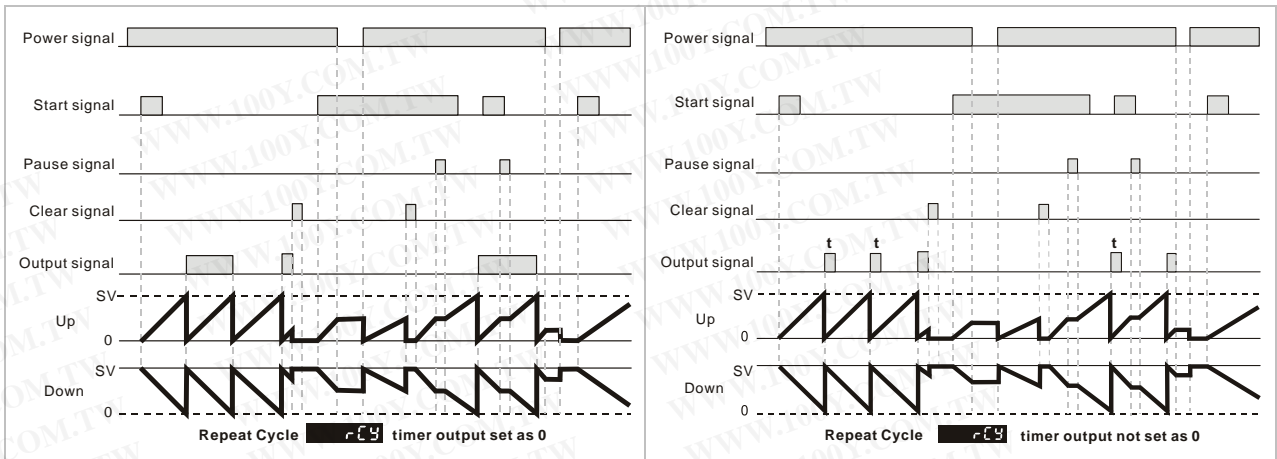

Repeat Cycle (RCY)

Output in cycle.

When the output time is selected as 0 (left: continuous output), the output of the first timing cycle will not be executed. When the set time is reached, the timing will be reset and restarted and the output will be enabled until the next cycle.

When the output time is not 0 (right), the output time will be different from when the output time is 0.

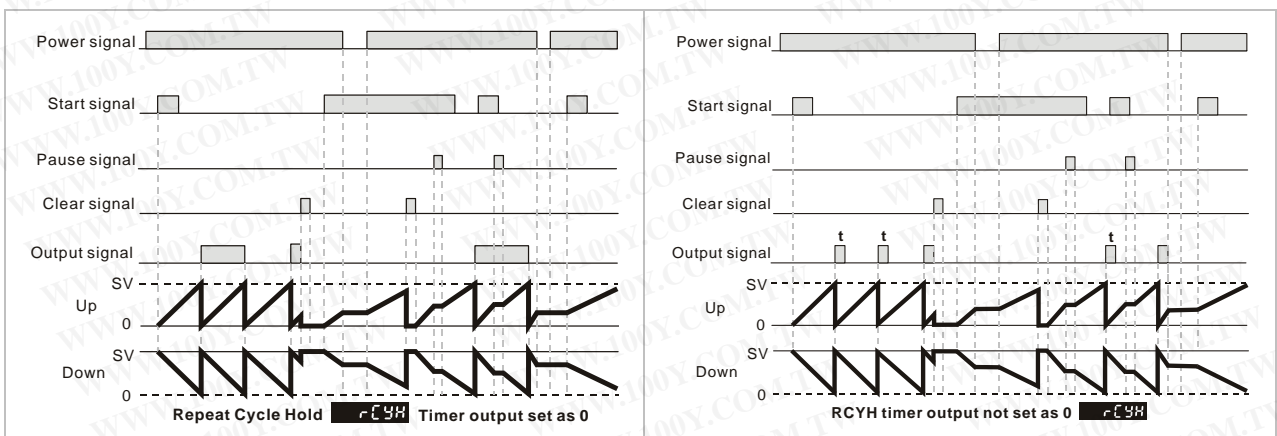

Repeat Cycle Hold (RCYH)

Same as "RCY"

The only difference is whether the current value is held when the power is switched off. In RCYH, After the power is switched on, the timer will resume the timing.

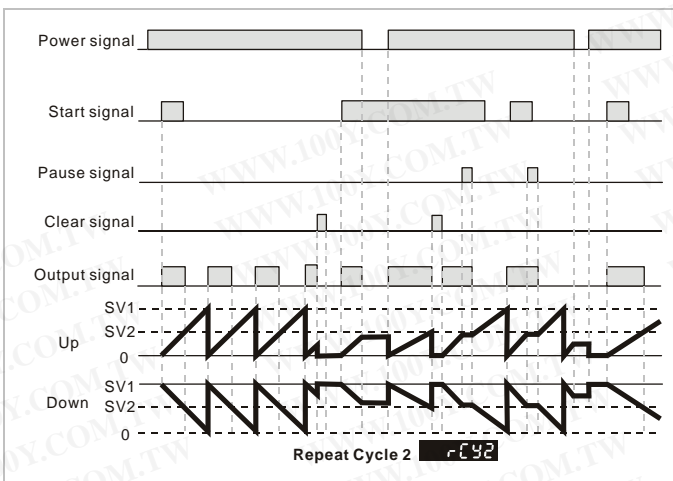

Repeat Cycle2 (RCY2)

Output in cycle.

The start signal starts to time and output when the rising edge is triggered and the clear signal is not executed. When the set time SV2 is reached, the output will be disabled and the timer continue to time until the set time SV1 is reached and the timer will start the timing again.

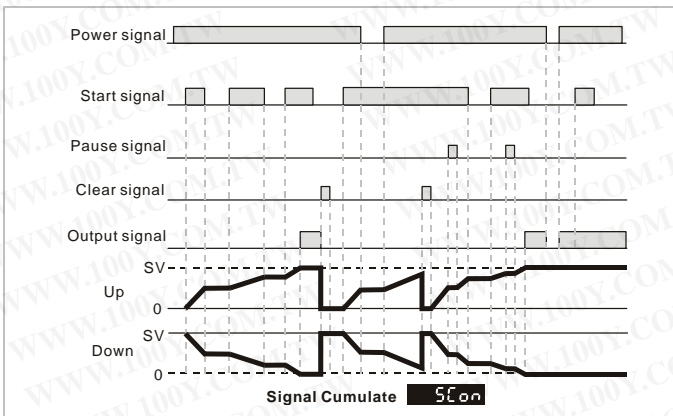

Signal Cumulate (SCON)

Latched cumulate timer.

When the start signal is enabled (Hi), the timing will start until the set time is reached for output. During the execution of clear signal, the timer is reset and waits for the start signal to be enabled (Hi) again. CTA will resume the timing.

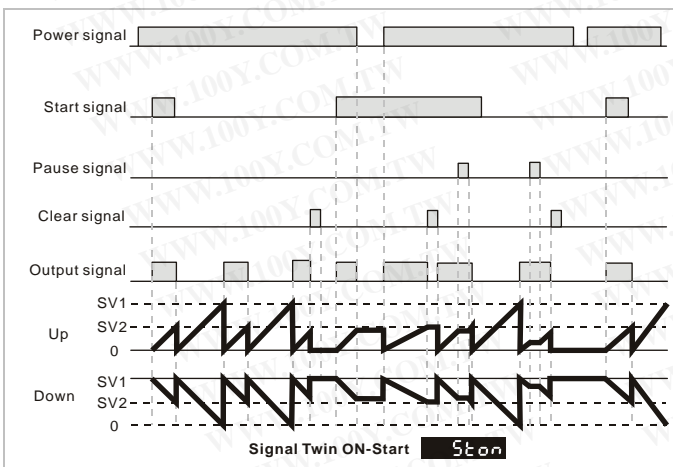

Signal Twin ON-Start (STON)

Output in cycle.

The start signal starts to time and output when the rising edge is triggered and the clear signal is not executed. When the set time SV2 is reached, the output will be disabled and the timer will restart the timing from 0 until it reaches the set time SV1 and turn Off.

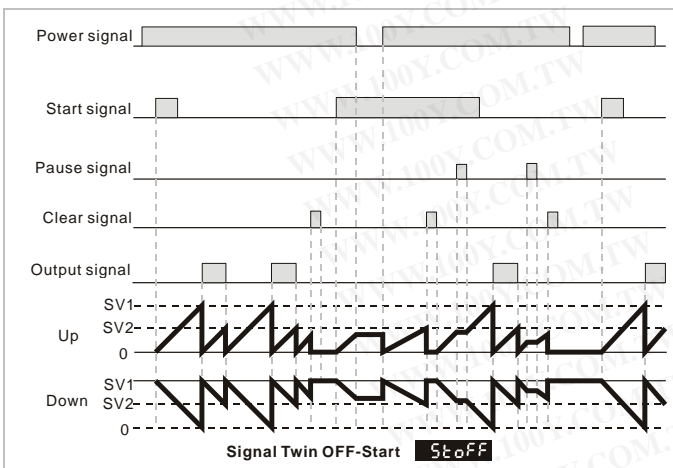

Signal Twin Off-Start (STOFF)

Output in cycle.

The start signal starts to time when the rising edge is triggered and the clear signal is not executed. When the set time SV1 is reached, the output will be On and the timer will restart the timing from 0 until it reaches the set time SV2. The timer will then start the timing again and disable the output.

2.2 Counter

The counter functions include: 1-stage counting, 2-stage counting, batch counting, total counting and dual counting.

1-stage counting	Only 1 SV is allowed.
2-stage counting	2 SVs and 2 PVs are allowed.
Batch counting	When the PV equals SV, output 2 will be enabled and the batch PV will plus 1. This will repeat until the batch PV reaches batch SV and output 1 will be enabled.
Total counting	There is only one SV in total counting. When the PV equals SV, the output will be enabled. The clear signal will then be enabled, and the counting will restart and PV will be accumulated into the total counter.
Dual counting	For addition and subtraction of CP1 and CP2.

2.2.1 Setting up the parameters in the counter

To enter the page for parameter setting of the counter, press **MODE** in the main menu for more than 3 seconds. After the setup is completed, press **MODE** for more than 3 seconds under any of the parameter page you are in and return to the main menu.

FUNC → **Count** → **BATCH** → **TCY** → **TCRE**
MODE ↓ Select functions: There are 4 modes in CTA, (left to right) timer, counter, tachometer and timer + counter.

CntFUN → **STAGE1** → **STAGE2** → **BATCH** → **total** → **DUAL**
 ↓ Select counter functions: 1-stage counting, 2-stage counting, batch counting, total counting, dual counting.

CPnt → **UP** → **down** → **Ud A** → **Ud b** → **Ud C**
 ↓ Select input modes: counting up, counting down, command counting up/down, individual counting up/down, quadrature input

CPntnd → **A** → **n** → **0** → **n** → **2** → **P**
 → **9** → **A** → **S** → **E** → **d** →
 ↓ Select output modes: CTA offer 11 output modes, among which mode S, T and D are only valid with input modes Ud_A, Ud_b and Ud_C. See 2.2.2 for more details.

SPED → **10K** → **5K** → **1K** → **200** → **30** → **1**
 ↓ Select counting speed: Maximum 10Kcps; others 5K, 1K, 200, 30 and 1cps.

OUT1 → **002** → **000**
 ↓ Pulse width of output 1: The default output time is 0.02 second. When the parameter is set to 0.00 second, the output status will continue.

OUT2 → **002** → **000**
 ↓ Pulse width of output 2: This parameter is adjustable according to different output modes selected. If the output mode is C, the default output time will be 0.02 second. When the parameter is set to 0.00 second, the output status will continue.

PoCnt → **0** → **1** → **2** → **3**
 ↓ Set up the position of decimal point: 0 (no decimal point), 1 (one digit after decimal point), 2 (two digits after decimal point), 3 (three digits after decimal point)

PSCALE → **1000**
 ↓ Set up pre-scale value: 1.000 (default 1:1) Range: 0.001 ~ 99.999

PVERS → **CLEAR** → **SAVE**
 ↓ Save the data while switching off the power: When SAVE is selected, the PV will be saved; when CLEAR is selected, the PV will not be saved.

rtSr → **20** → **1**
 ↓ Set up minimum width of reset signal: Default = 20ms; 1ms is also selectable.

CPntLC → **nPN** → **pNP**
 ↓ Select input signal types: NPN and PNP

Back to Top

2.2.2 Setting up input mode of the counter

CTA offers 5 counting modes: counting up, counting down, command counting up/down, individual counting up/down and quadrature input.

The minimum signal width of the counting speed:

Counting speed	Minimum signal width
1cps	500ms
30cps	16.7ms
1Kcps	0.5ms
5Kcps	0.1ms
10Kcps	0.05ms

Counting up

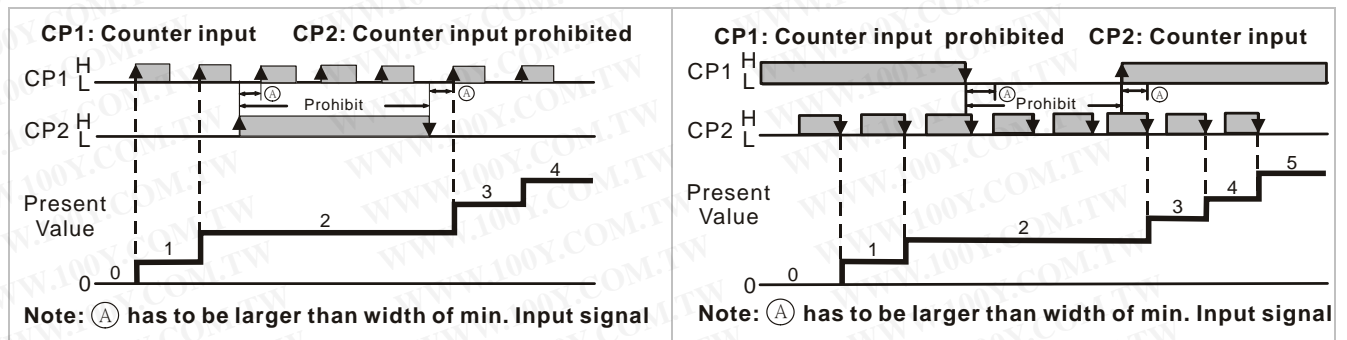

Counting down

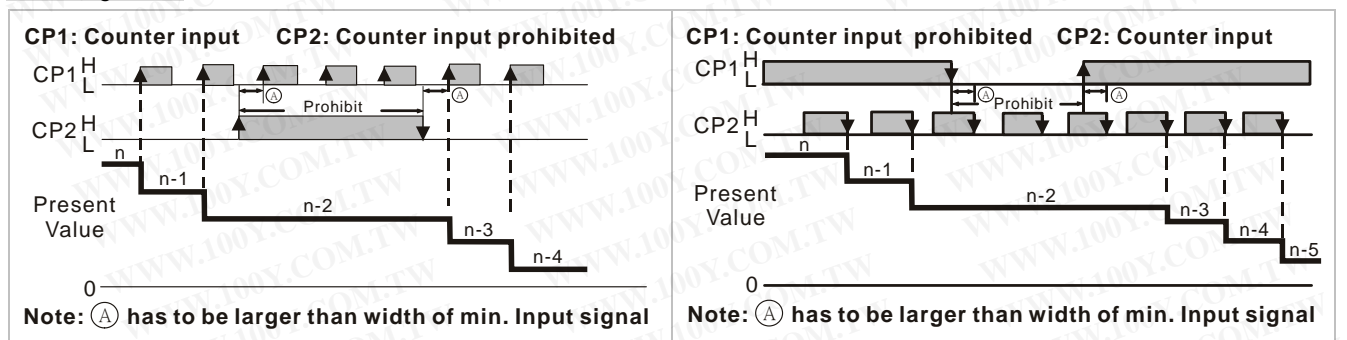

Command counting up/down

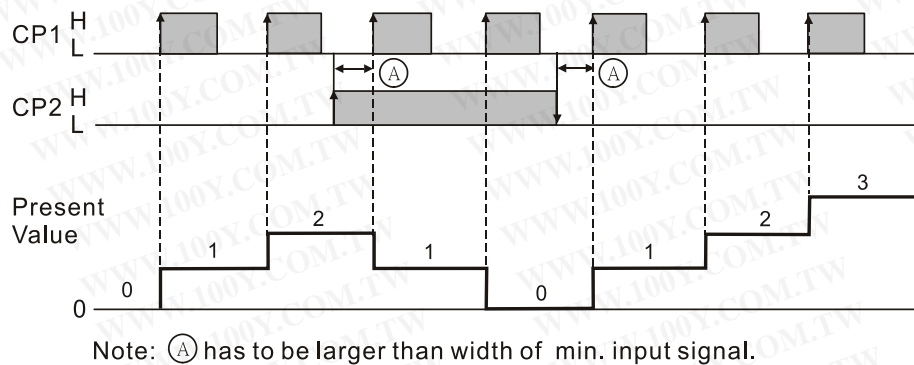

Individual counting up/down

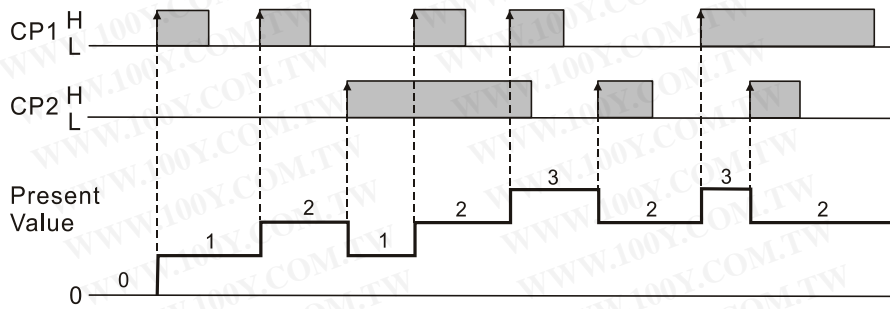

Quadrature input

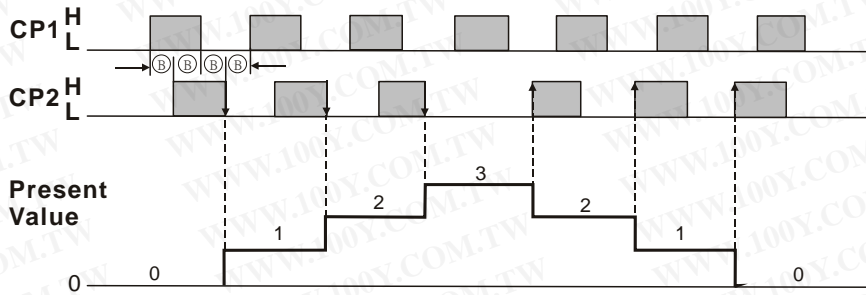

Note: \textcircled{B} has to be larger than width of 1/2 min. input signal.

2.2.3 Setting up output mode of the counter

CTA offers 11 output modes in the counter for 1-stage and 2-stage counting. When 1-stage output is selected, output 2 and output 1 will be operated in the same way.

Output mode setting	Input mode			Output mode setting	Input mode		
	Up	Down	Up/Down A, B, C		Up	Down	Up/Down A, B, C
F				K			
N				P			
C				Q			
R				A			

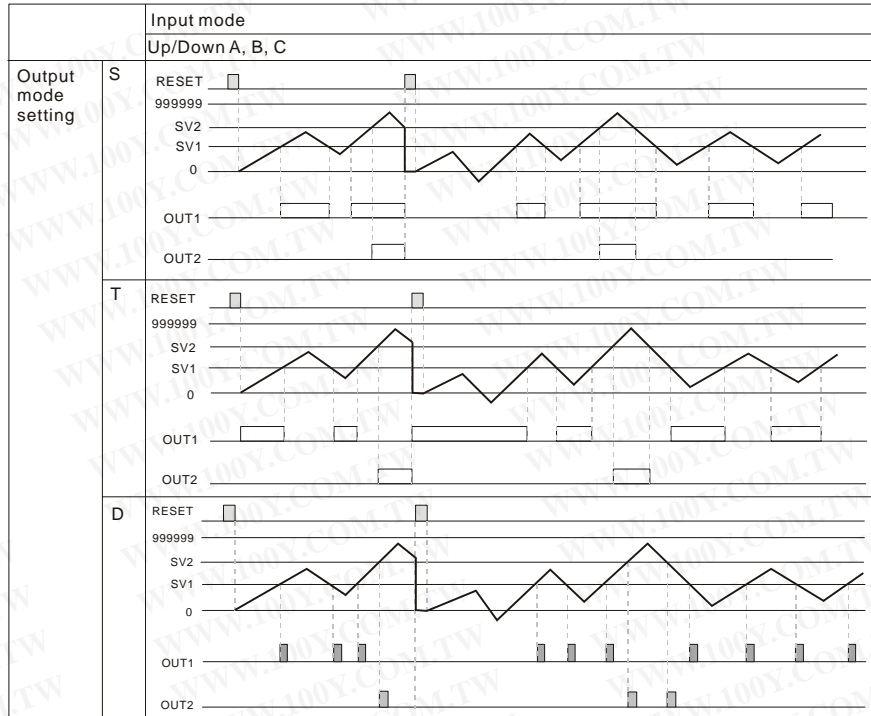

2.2.4 Batch counting

When the PV equals SV, output 2 will be enabled and the batch PV will plus 1. The PV will be cleared and the counting will restart. This will repeat until the batch PV reaches batch SV and output 1 will be enabled. For example: A fruit packaging machine has to package 100 boxes with 5 fruit in each box. In this case, set the SV as 5 and batch SV as 100. When the belt starts to package the fruit, output 2 will inform the motor of the moving and plus 1 to the batch counter. After repeating the process for 100 times, i.e. 500 fruit of 100 boxes are packaged, output 1 will be enabled and notify the user by sound, light or indicator that the packaging has been completed.

Batch Counting

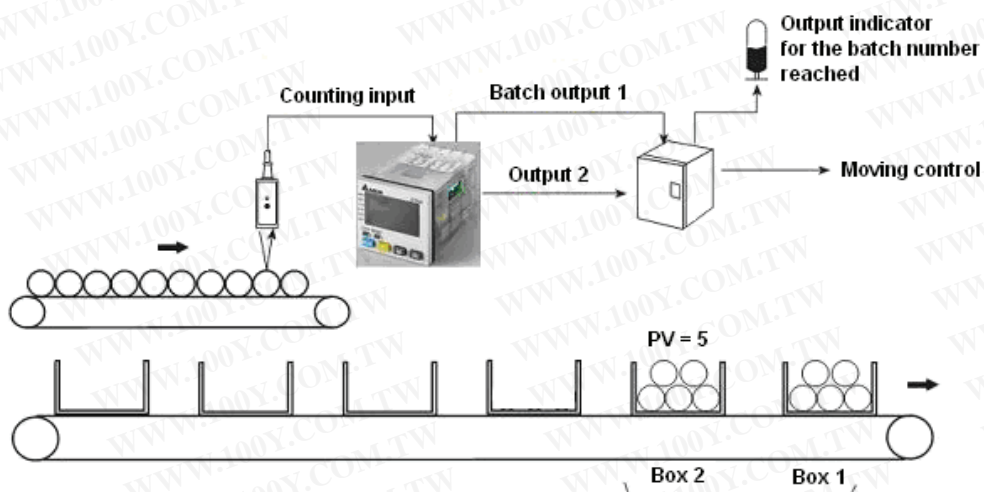

2.2.5 Total counting

There is only one SV in total counting. When the PV equals SV, the output will be enabled. If the clear signal is enabled now, the counting will restart and PV will be accumulated into the total counter.

For example: An egg packaging machine packages 5 eggs as a unit. After the 5 eggs are packaged, output 1 and output 2 will be enabled at the same time and the motor will be informed to move to the next package. This process will repeat and record the number of eggs packaged in the total counter for the user to check at any time.

Total Counting

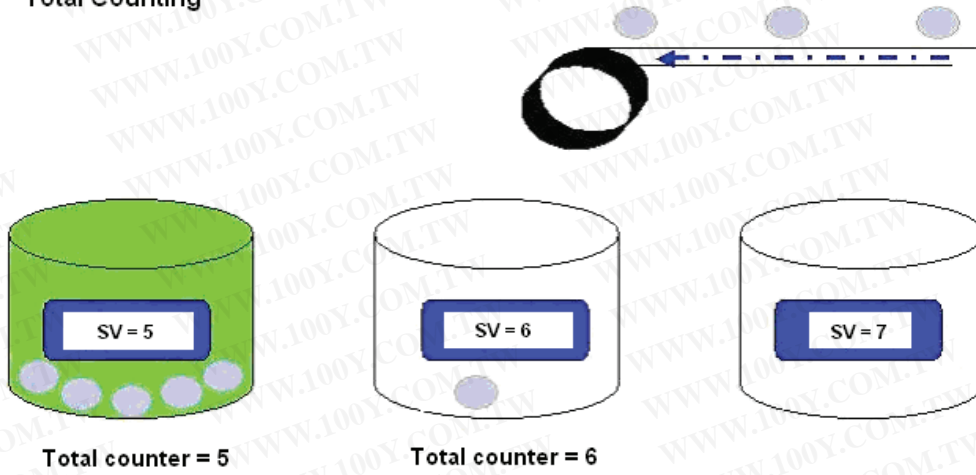

2.3 Tachometer

The tachometer in CTA measures the pulse width and displays the current frequency. The measuring and displaying unit in the tachometer is frequency (Hz); therefore, if you want the value to be displayed in rotation speed (rpm), you have to convert the frequency into rotation speed. See 2.3.3 for how to convert.

2.3.1 Setting up the parameters in the tachometer

To enter the page for parameter setting of the tachometer, press **MODE** in the main menu for more than 3 seconds. After the setup is completed, press **MODE** for more than 3 seconds under any of the parameter page you are in and return to the main menu.

FUNC → **FUNC** → **2CY** → **2C2E** → **Cont**
MODE ↓ Select functions: There are 4 modes in CTA, (left to right) timer, counter, tachometer and timer + counter.

2Lo1Lo → **2Lo1Hi** → **2Hi1Lo** → **2Hi1Hi**
 ↓ Select output modes: There are 4 output modes, 2Lo1Lo, 2Lo1Hi, 2Hi1Lo and 2Hi1Hi. For example, when you select 2Hi1Lo, and assume the first set value is 100 (2Hi) and the second 50 (1Lo), the output value of the tachometer will be below 100 (2Hi) and above 50 (1Lo) and CTA will not perform an output. If the set value exceeds the range, CTA will perform an output.

C SPED → **10K** → **5K** → **1K** → **200** → **30** → **1**
 ↓ Select rotation speed: Maximum 10Kcps; others 5K, 1K, 200, 30 and 1cps.

Point → **0** → **1** → **2** → **3**
 ↓ Set up the position of decimal point: 0 (no decimal point), 1 (one digit after decimal point), 2 (two digits after decimal point), 3 (three digits after decimal point)

PSCALE → **1000**
 ↓ Set up pre-scale value: 1.000 (default 1:1) Range: 0.001 ~ 99.999

St tRC → **00**
 ↓ Set up the delay time after switching on the power: 0.0 (default). The tachometer will start to run when the set delay time is due after the power is switched on. Setup range: 0.1 ~99.9 seconds.

St Avg → **0** → **1** → **2** → **3**
 ↓ Set up average value of the input filter: The average value is for making the present value detected by the tachometer more stable. The setup range is 0 ~ 3 (1 = 2 data, 2 = 4 data, 3 = 8 data). For example, if you select "3", the system will average the 8 present values from the tachometer to make the present value displayed on the screen more stable.

rtSr → **20** → **1**
 ↓ Set up minimum width of reset signal: Default = 20ms; 1ms is also selectable.

INP tC → **NPN** → **PNP**
 ↓ Select input signal types: NPN and PNP.

Back to Top

2.3.2 Setting up output mode of the tachometer

There are 4 output modes in the tachometer, 2Lo1Lo, 2Lo1Hi, 2Hi1Lo and 2Hi1Hi.

Take 2Lo1Lo for example, assume the set value of output 2 is 100 and 50 for output 1, when the present value measured by the tachometer is below 50, output 1 and output 2 will both be enabled.

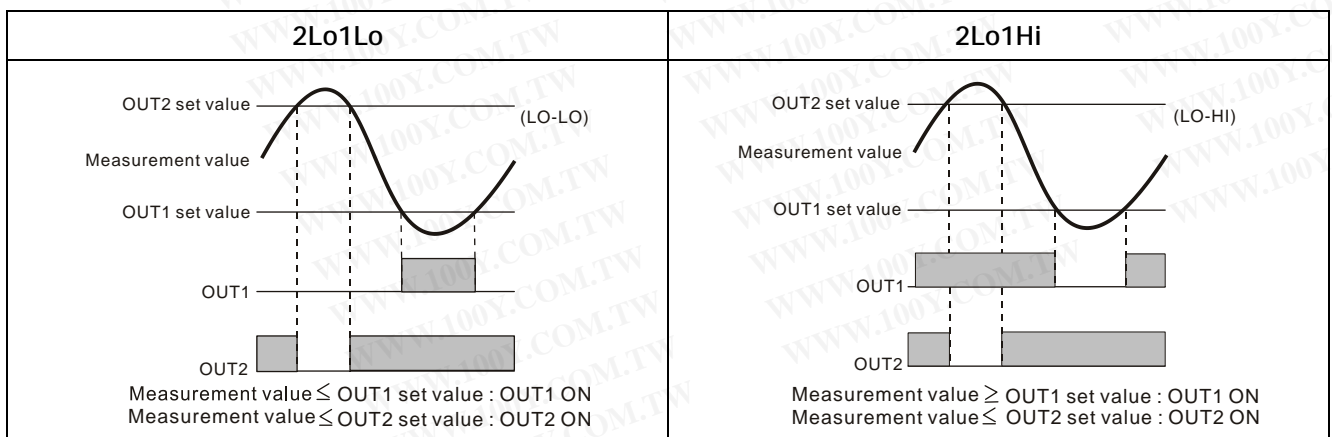

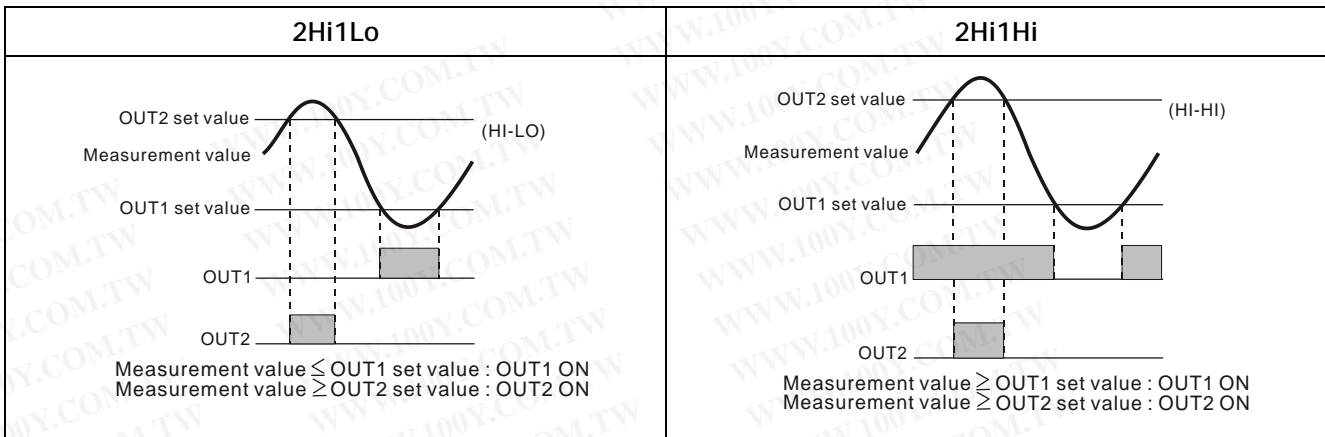

2.3.3 Calculating the unit of rotation speed

The tachometer is able to receive an open collector type input signal of maximum 10KHz and displays the unit as Hz on the screen of the tachometer. Therefore, if you wish the rotation speed to be displayed in rpm, you have to convert Hz into rpm by an equation and fill the obtained value into **PSCALE** of the tachometer to display the rotation speed in rpm on the screen.

The conversion equation:

$$\text{Frequency (Hz)} \times \text{Pre-scale} = \text{Rotation Speed (rpm)}$$

$$\text{Pre-scale} = 60/N$$

※N = Number of pulses per revolution (ppr)

Example 1: Connecting Delta servo drive with a servo motor and measure the current rotation speed by CTA

The built in encoder in Delta servo motor is 10,000ppr with four phases, OA, OB, \overline{OA} and \overline{OB} . Every phase is 2,500ppr.

$$\text{Pre-scale} = 60/2,500 = 0.024$$

At this time, the servo inputs 240rpm, equivalent to the tachometer receiving 10KHz currently.

Frequency and rotation speed of CTA connected to Delta servo drive:

Frequency	Rotation speed
10KHz	240rpm
5KHz	120rpm
1KHz	24rpm
200Hz	4.8rpm

Note: OA and OB of Delta ASD servo motor A and B series only support differential signals. OZ (10,000ppr) supports open collector.

Example 2: Measuring the current rotation speed of the AC fan motor through a sensor

Figure 1: 1 revolution of the fan equals 1 pulse; therefore

$$\text{Pre-scale} = 60/N = 60/1 = 60$$

At this time, the sensor detects the speed and sends it back to tachometer. Assume the value displayed on the screen is 2,700rpm,

$$F \times 60/1 = 2,700$$

$$F = 45\text{Hz}$$

Figure 2: 1 revolution of the fan equals 3 pulses; therefore

$$\text{Pre-scale} = 60/N = 60/3 = 20$$

At this time, the sensor detects the speed and sends it back to tachometer. Assume the value displayed on the screen is 3,200rpm,

$$F \times 60/3 = 3,200$$

$$F = 160\text{Hz}$$

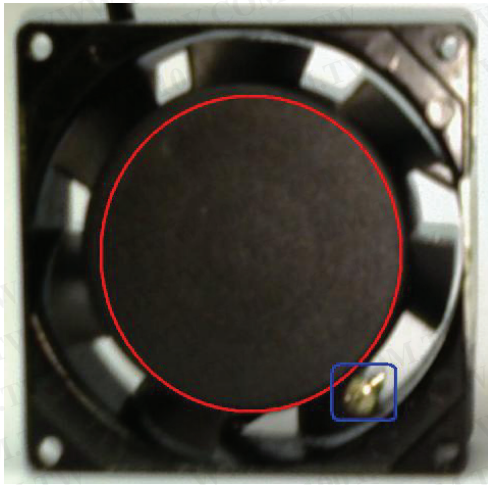

Figure 1



Figure 2

2.4 Timer + Counter (Mixed Mode)

CTA offers timer + counter mode. The timer corresponds to OUT1 (output 1) and the counter to OUT2 (output2). In this mode, the timer and counter both have a phase signal input; therefore, part of the functions will be limited. For example, there are 12 output modes for the timer of CTA, but only 8 output modes available in the timer + counter mode (Rcy2, Scon, Ston and Stoff are not available). In addition, the mixed mode only offers input modes Up and Down for the counter and S, T, D are no longer available in the output modes. See 2.4.1. for how to set up the parameters in the mixed mode.

2.4.1 Setting up the parameters in the "timer + counter"

To enter the page for parameter setting of the timer + counter, press **MODE** in the main menu for more than 3 seconds. After the setup is completed, press **MODE** for more than 3 seconds under any of the parameter page you are in and return to the main menu.

FUNC → **TCY** → **TCRE** → **Cont** → **TRCH**

MODE ↓ Select functions: There are 4 modes in CTA, (left to right) timer, counter, tachometer and timer + counter.

t mode → **UP** → **down**

↓ Select timer mode: counting up and counting down

t ctnd → **Sond1** → **Sond2** → **Stoffd** → **Son** → **Pond** → **PondH**

→ **rCY** → **rCYH**

↓ Select output modes: There are 8 output modes. The user can choose the mode that best meets the demand. See 2.1.3 for more details.

t Unct → **S 001** → **S 01** → **S 1** → **AS 001** → **AS 01** → **R 01**

→ **n 1** → **WAS 1** → **W 1** → **H 1**

↓ Select display unit: the min. unit 10ms ~ the max. unit hour are selectable

C UnPt → **UP** → **down**

↓ Select input modes: Only counting up and counting down are available. See 2.2.2 for more details.

C ctnd → **U** → **n** → **C** → **n** → **U** → **n**

→ **U** → **n**

↓ Select output modes: Same as the output modes of the counter except for S, T, D. See 2.2.3 for more details.

C SPed → **5K** → **1K** → **200** → **30** → **1**

↓ Select counting speed: Maximum 5Kcps; others 1K, 200, 30 and 1cps.

t out1 → **0.02** → **0.00**

↓ Select pulse width of output 1: The default output time is 0.02 second. When the parameter is set to 0.00 second, the output status will continue.

t out2 → **0.02** → **0.01**

↓ Pulse width of output 2: This parameter is adjustable according to different output modes selected. If the output mode is C, the default output time will be 0.02 second. When the parameter is set to 0.00 second, the output status will continue.

Point → **0** → **1** → **2** → **3**

↓ Set up the position of decimal point: 0 (no decimal point), 1 (one digit after decimal point), 2 (two digits after decimal point), 3 (three digits after decimal point)

PSCALE → **1.000**

↓ Set up pre-scale value: 1.000 (default 1:1) Range: 0.001 ~ 99.999

PVERS → **CLEAR** → **SAVE**

↓ Save the data while switching off the power: When SAVE is selected, the PV will be saved; when CLEAR is selected, the PV will not be saved.

rtSn → **20** → **1**

↓ Set up minimum width of reset signal: Default = 20ms; 1ms is also selectable.

CnPtC → **nPN** → **PnP**

↓ Select input signal types: NPN and PNP

Back to Top

CHAPTER THREE: APPLICATIONS

3.1 On Cut-To-Length Machines

The machine adopts the counter function in CTA and acquires the feedback signal from the encoder for measuring the actual operation distance. When the set distance is reached, the output signal will enable the knife for the cutting.

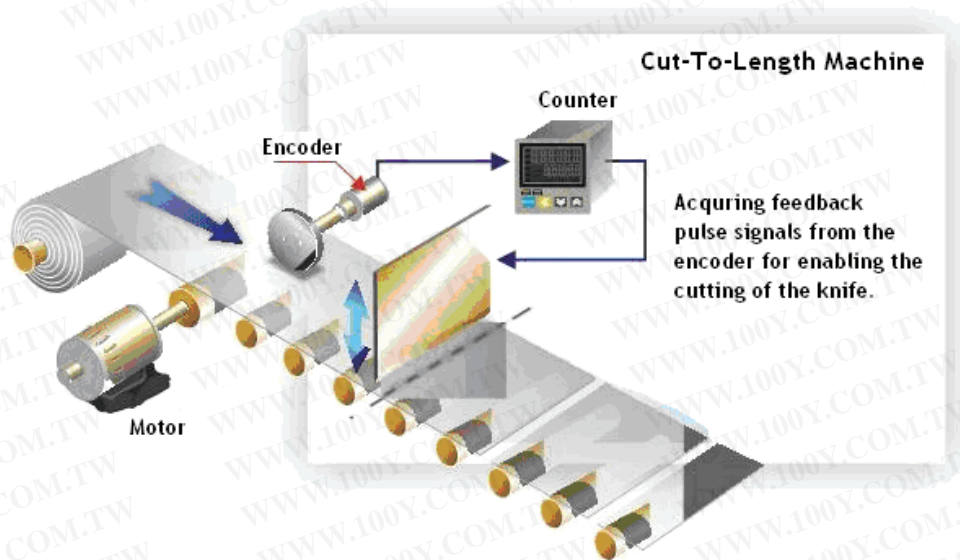

Example: We will simulate the action above by using CTA and Delta ASDA-A.

Parameter settings

- FUNC** → **Count**
↓
Select function: Counter
- CntFUN** → **STAGE 1**
↓
Select counting mode: 1-stage counting (only 1 set value). If you need 2 set values, select 2-stage counting.
- C INPt** → **Qd C**
↓
Select input mode: Quadrature input
- C outMd** → **C**
↓
Select output mode: C; the counting will automatically restart when the set value is reached.
- C SPED** → **10K**
↓
Select counting speed: The maximum 10K
- t out2** → **0.02**
↓
Set up pulse width of output 2: 0.02 second
- POCnt** → **0**
↓
Set up the position of decimal point: 0 (no decimal point)
- PSCALE** → **0.056**
↓
Set up pre-scale value: 0.056
- PRES** → **CLEAR**
↓
Save the data while switching off the power: Select CLEAR, and the PV will not be saved.
- rtSr** → **20**
↓
Set up min. width of reset signal: select default value 20ms.
- CnPtC** → **NPN**
↓
Select input signal type: NPN

Back to Top

■ Output Wiring

Connect ⑪ 0V, ⑫ CP1 (phase A) and ⑬ CP2 (phase B) to CN1 terminal on ASDA-A servo drive

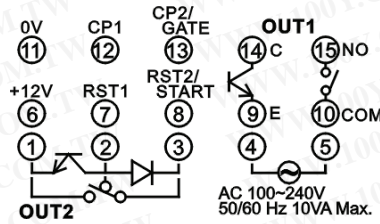

Assume

The set value in the CTA counter is 160mm. When the counting reaches 160mm, an output signal will be given to the knife for the cutting. See figure 2.

In the figure, we can see the diameter of the roller is 44.8mm
Delta encoder 1 phase = 2,500ppr

Calculate the pre-scale value

$$\frac{\pi D}{ppr} = \text{Prescale}$$

π : 3.1416

D: diameter of the roller

ppr: number of pulses per revolution of the encoder

$$\text{Prescale} = \frac{\pi D}{ppr} = \frac{3.1416 \times 44.8}{2500} = 0.056\text{mm/pulse}$$

When the value in CTA = 2,858

2858 x 0.056 = 160mm (actual moving distance)

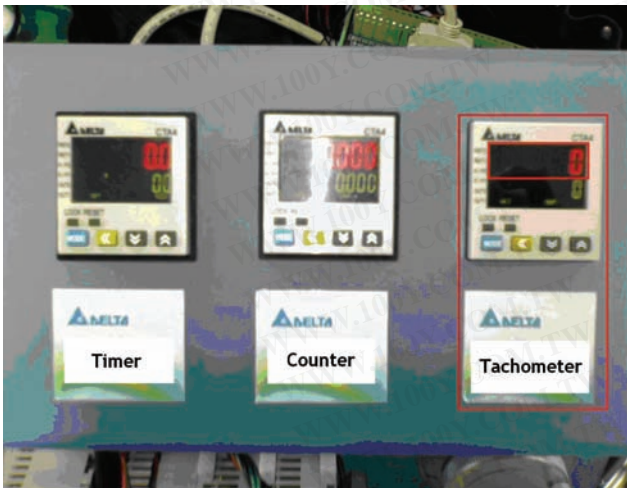

Figure 1

SV has to be 160mm

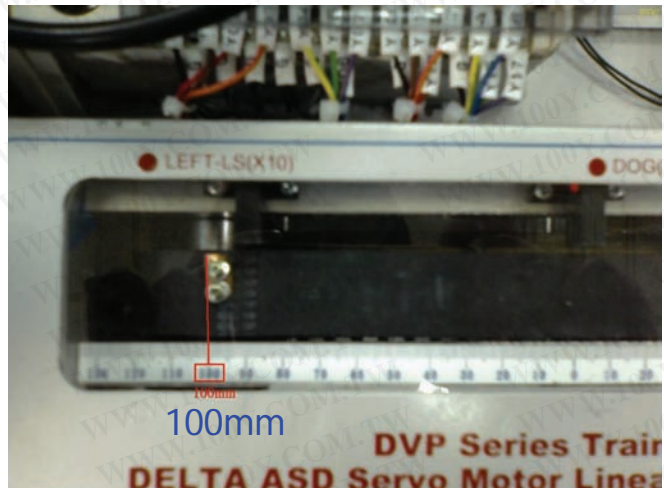

Figure 2

The servo drive stops at 100mm on the ruler before its operation



Figure 3

When the tachometer reaches 160mm, the output will be enabled.

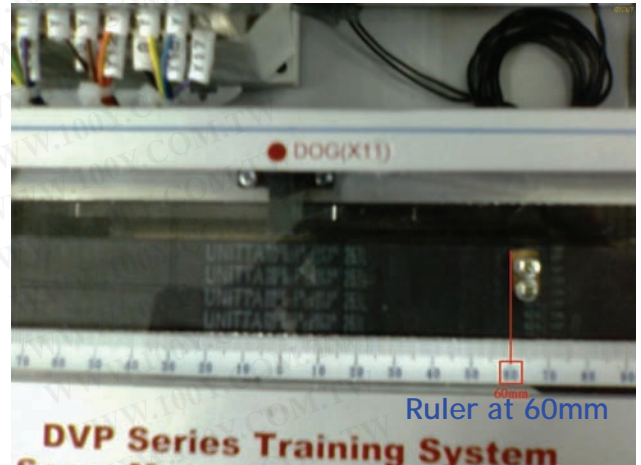

Figure 4

The distance moved is 160mm. The ruler stops at 60mm.

勝特力材料 886-3-5753170
 勝特力电子(上海) 86-21-34970699
 勝特力电子(深圳) 86-755-83298787
[Http://www.100y.com.tw](http://www.100y.com.tw)