

SPECIFICATIONS:

CONTACT RATING: Refer to "Contact Material Options" for more info.
 ELECTRICAL LIFE: 50,000 make-and-break cycles at full load.
 CONTACT RESISTANCE: 10mΩmax. initial @2-4VDC
 100mA for both silver and gold plated contacts.
 INSULATION RESISTANCE: 1,000MΩmin.
 DIELECTRIC STRENGTH: 1,500V RMS @ sea level.
 OPERATING TEMPERATURE: -30°C to +85°C

MATERIALS:

CASE: Diallyl phthalate(DAP)(UL 94V-0)
 TOGGLE HANDLE: Brass, chrome plated.
 BUSHING: Brass, nickel plated.
 HOUSING: Stainless Steel.
 TERMINAL SEAL: Epoxy.

If your preferred product configuration is not shown, please contact our sales representative for custom design.

HOW TO ORDER SYSTEM

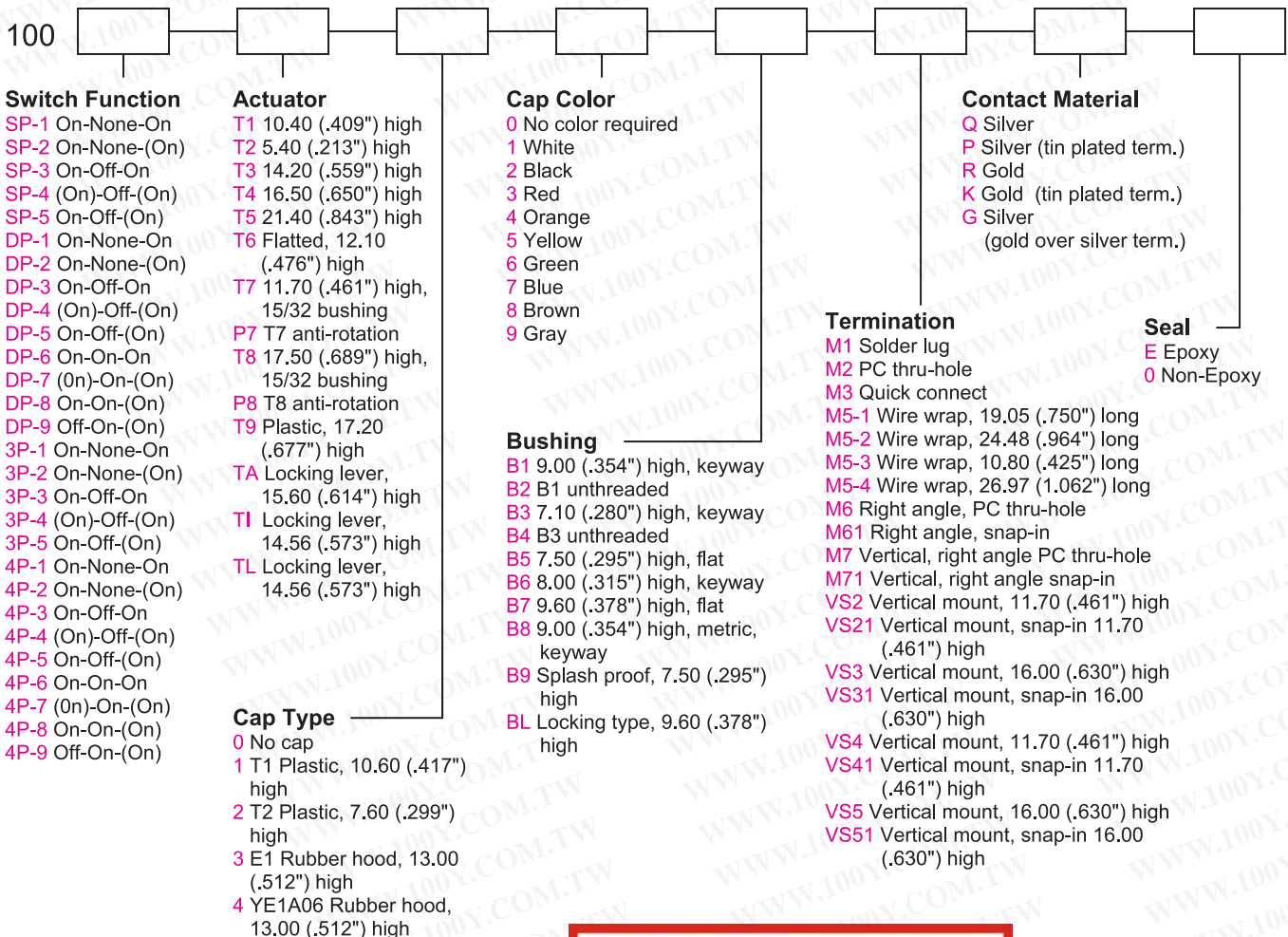

Note:
 No cap type required for T9 actuator

勝特力材料 886-3-5753170
 勝特力电子(上海) 86-21-34970699
 勝特力电子(深圳) 86-755-83298787
[Http://www.100y.com.tw](http://www.100y.com.tw)

SPDT



Model No.	Switching Position		
SP-1	ON	NONE	ON
SP-2	ON	NONE	(ON)
SP-3	ON	OFF	ON
SP-4	(ON)	OFF	(ON)
SP-5	ON	OFF	(ON)
Term. Comm.	2-3	OPEN	2-1

Schematic

O2Comm.

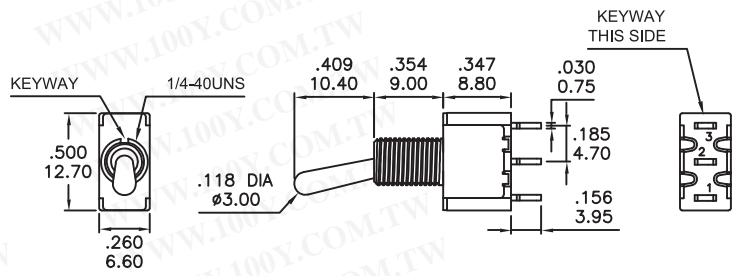

DPDT



Model No.	Switching Position		
DP-1	ON	NONE	ON
DP-2	ON	NONE	(ON)
DP-3	ON	OFF	ON
DP-4	(ON)	OFF	(ON)
DP-5	ON	OFF	(ON)
Term. Comm.	2-3,5-6	OPEN	2-1,5-4

Schematic

O2Comm.

O5Comm.

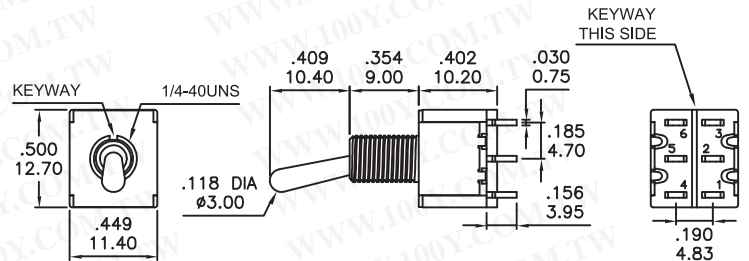

WIRING FOR ON-ON-ON (3-WAY) FUNCTION

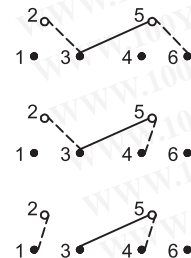
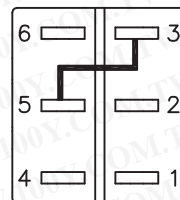

3PDT



Model No.	Switching Position		
3P-1	ON	NONE	ON
3P-2	ON	NONE	(ON)
3P-3	ON	OFF	ON
3P-4	(ON)	OFF	(ON)
3P-5	ON	OFF	(ON)
Term. Comm.	2-3,5-6 8-9	OPEN	2-1,5-4 8-7

Schematic

O2Comm.

O5Comm.

O8Comm.

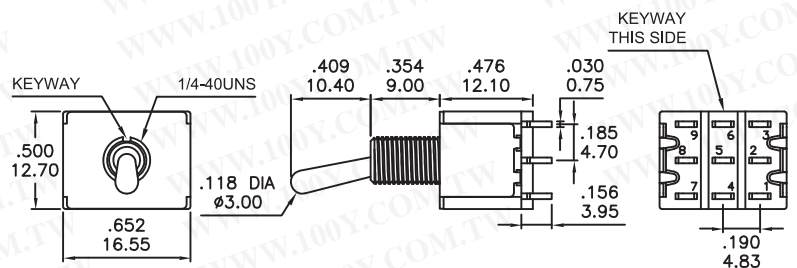

Series 100

Miniature Toggle Switches

4PDT



Model No.	Switching Position		
4P-1	ON	NONE	ON
4P-2	ON	NONE	(ON)
4P-3	ON	OFF	ON
4P-4	(ON)	OFF	(ON)
4P-5	ON	OFF	(ON)
Term. Comm.	2-3,5-6 8-9 11-12	OPEN	2-1,5-4 8-7 11-10

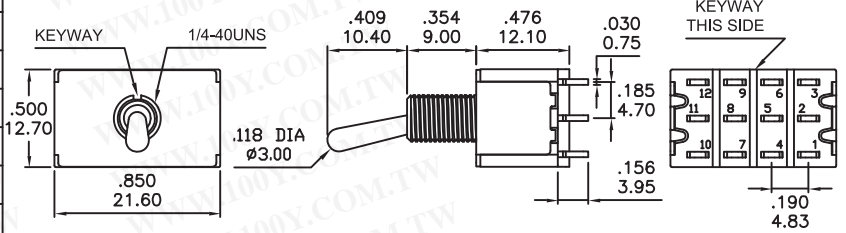

Model No.	Switching Position		
4P-6	ON	ON	ON
4P-7	(ON)	ON	(ON)
4P-8	ON	ON	(ON)
4P-9	OFF	ON	(ON)
Term. Comm.	2-3,5-6 8-9 11-12	2-3,5-4 8-9 11-10	2-1,5-4 8-7 11-10

WIRING FOR ON-ON-ON (3-WAY) FUNCTION

Schematic

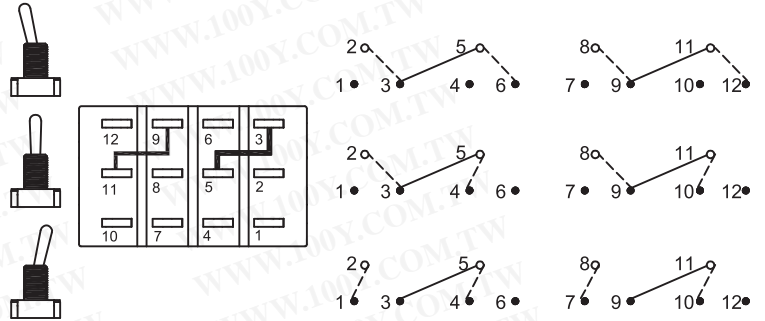
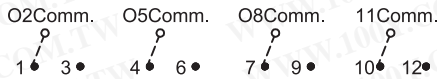

ACTUATOR OPTIONS

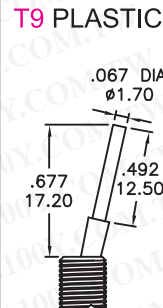
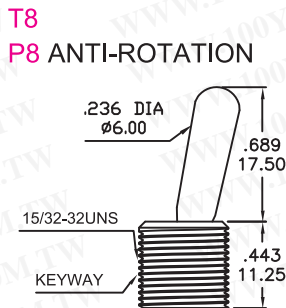
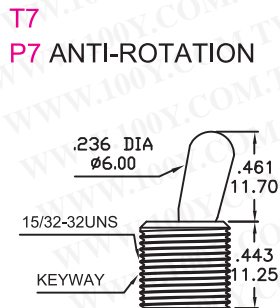
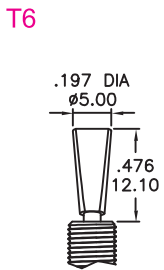
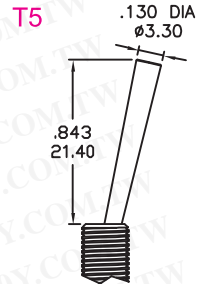
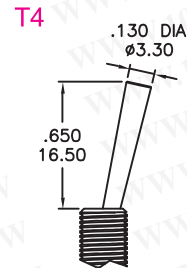
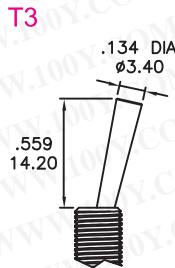
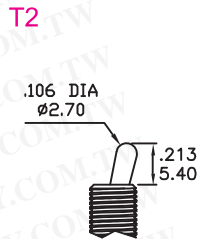
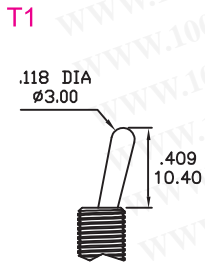

NO.	COLOR
1	White
2	Black(std.)
3	Red
4	Orange
5	Yellow
6	Green
7	Blue
8	Brown
9	Gray

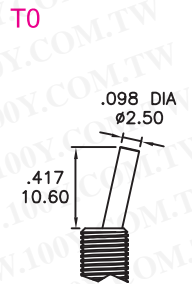

LOCKING LEVER

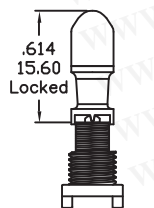
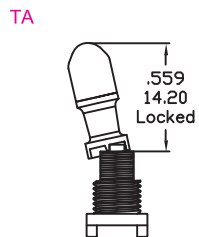

FOR SP-1,DP-1
3P-1,4P-1 ONLY

FOR SP-3,DP-3
3P-3,4P-3 ONLY

LOCKING LEVER

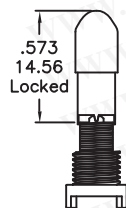
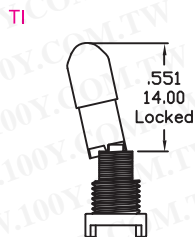

FOR SP-1,DP-1
3P-1,4P-1 ONLY

FOR SP-3,DP-3
3P-3,4P-3 ONLY

LOCKING LEVER

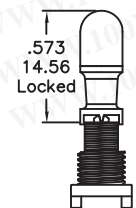
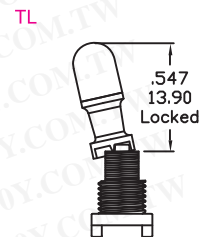

FOR SP-1,DP-1
3P-1,4P-1 ONLY

FOR SP-3,DP-3
3P-3,4P-3 ONLY

* T6 must configure with a stand-off bushing.

* For T7,P7,T8,P8 bushing code is not required.

* Actuator length shown for T1 ~ T5 and T9 ~ T0 is with B1 bushing.

()=MOMENTARY

BUSHING OPTIONS

<p>B1 THD B2 NON-THD</p>	<p>B3 THD B4 NON-THD</p>	<p>B5 HIGH TORQUE</p>	<p>B6 HIGH TORQUE</p>
<p>B7 LONG</p>	<p>B8 METRIC</p>	<p>B9 SPLASH-PROOF</p>	<p>BL LOCKING LEVER</p>
<p>BA THD For T6</p>	<p>BB NON-THD For T6</p>	<p>BE HIGH TORQUE For T6</p>	

PANEL MOUNTING

<p>1/4 INCH BUSHING</p>	<p>15/32 INCH BUSHING</p>
--------------------------------	----------------------------------

TERMINATION OPTIONS

<p>M1 STD. SOLDER LUG</p>	<p>M2 PC THRU-HOLE</p>	<p>M3 QUICK CONNECT</p>	<p>M5 WIRE WRAP</p> <table border="1"> <thead> <tr> <th>OPTION CODE</th> <th>DIM.'A'</th> </tr> </thead> <tbody> <tr> <td>M5-1</td> <td>.750(19.05)</td> </tr> <tr> <td>M5-2</td> <td>.964(24.48)</td> </tr> <tr> <td>M5-3</td> <td>.425(10.80)</td> </tr> <tr> <td>M5-4</td> <td>1.062(26.97)</td> </tr> </tbody> </table>	OPTION CODE	DIM.'A'	M5-1	.750(19.05)	M5-2	.964(24.48)	M5-3	.425(10.80)	M5-4	1.062(26.97)
OPTION CODE	DIM.'A'												
M5-1	.750(19.05)												
M5-2	.964(24.48)												
M5-3	.425(10.80)												
M5-4	1.062(26.97)												

TERMINATION OPTIONS

M6

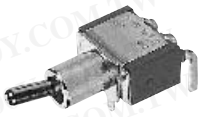

SPDT

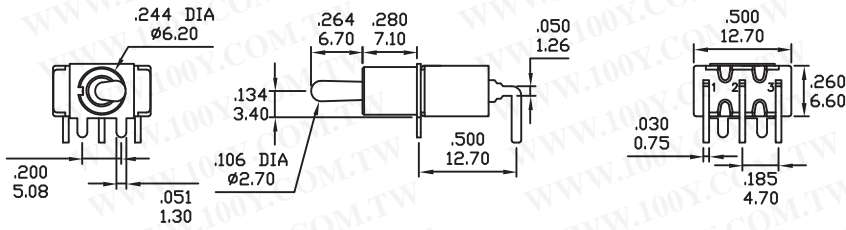

P.C.MOUNTING

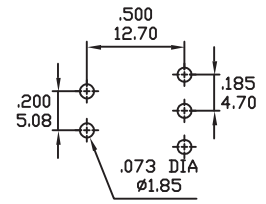

M6

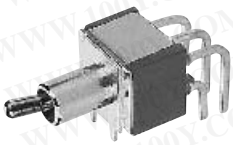

DPDT

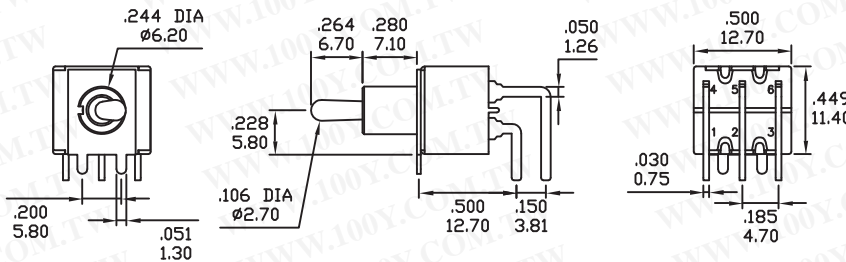

P.C.MOUNTING

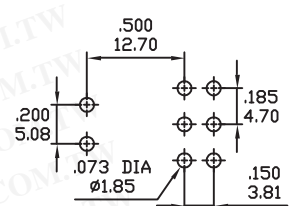

M6

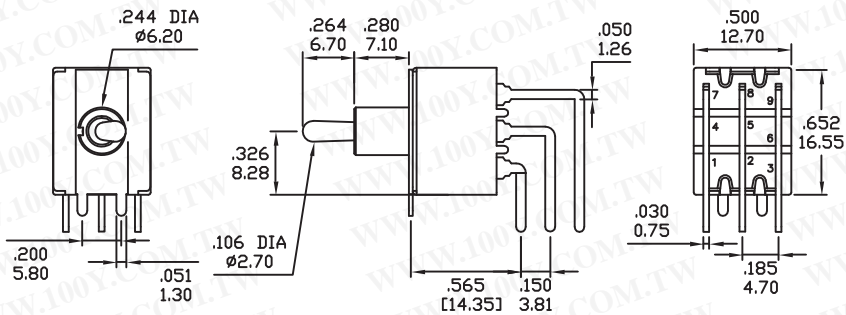

P.C.MOUNTING

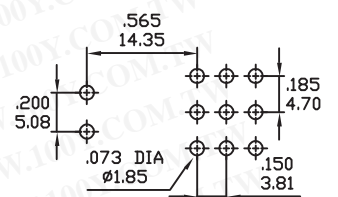

M7

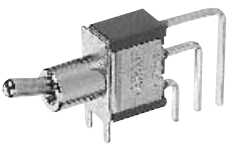

SPDT

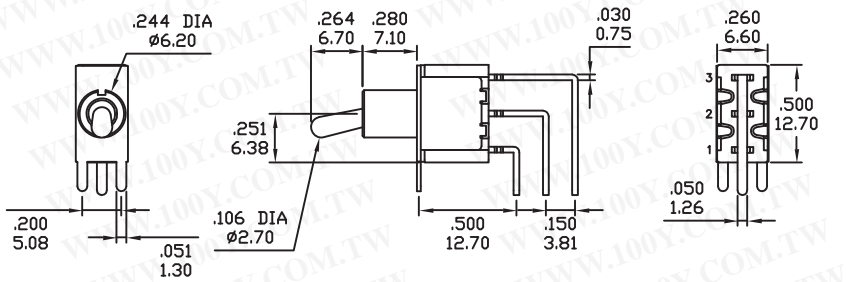

P.C.MOUNTING

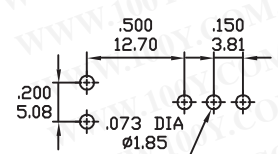

M7

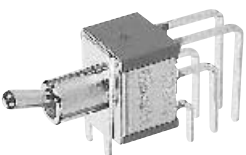

DPDT

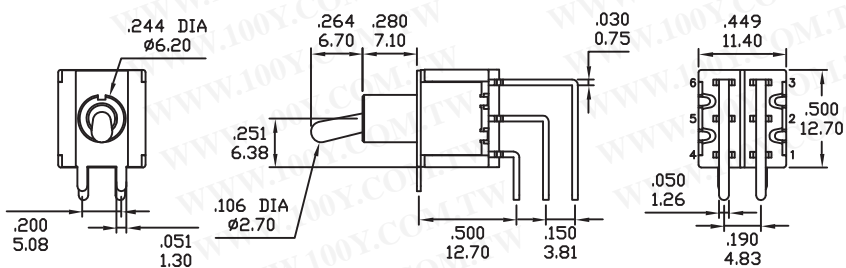

P.C.MOUNTING

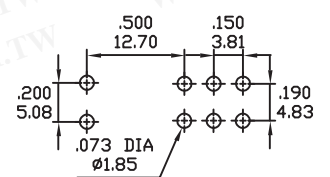

TERMINATION OPTIONS

M7

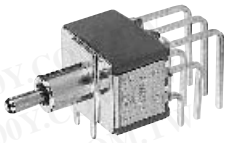

3PDT

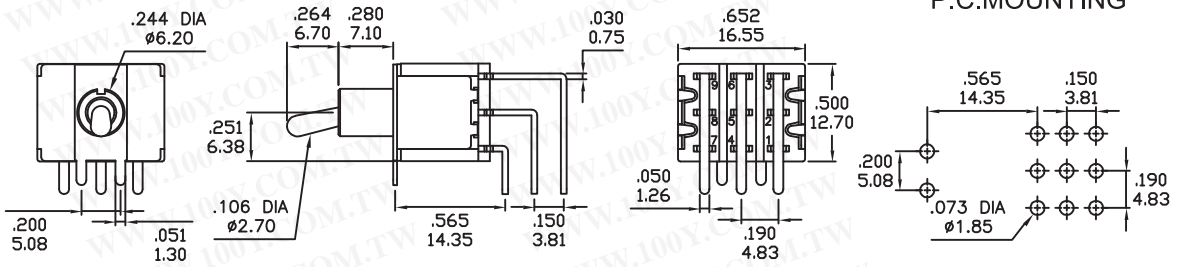

P.C.MOUNTING

M7

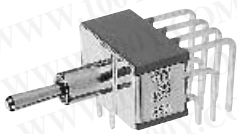

4PDT

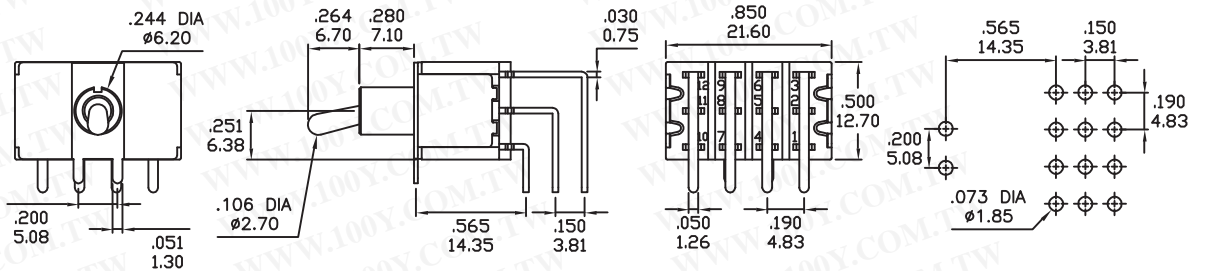

P.C.MOUNTING

VS2-VS3

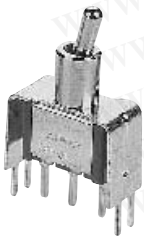

SPDT

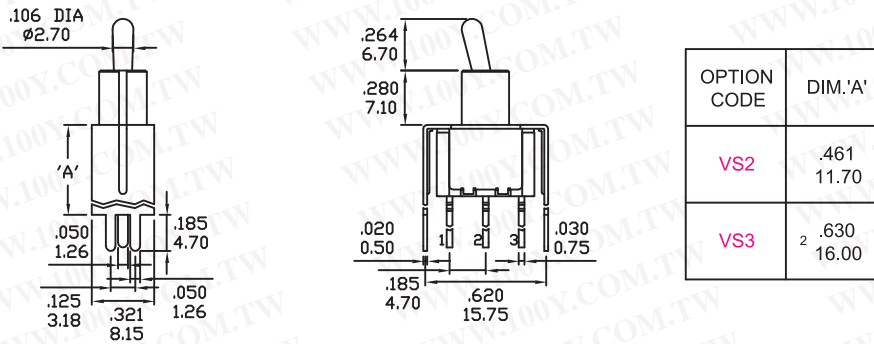

P.C.MOUNTING

VS2-VS3

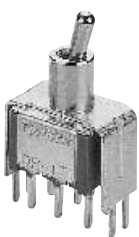

DPDT

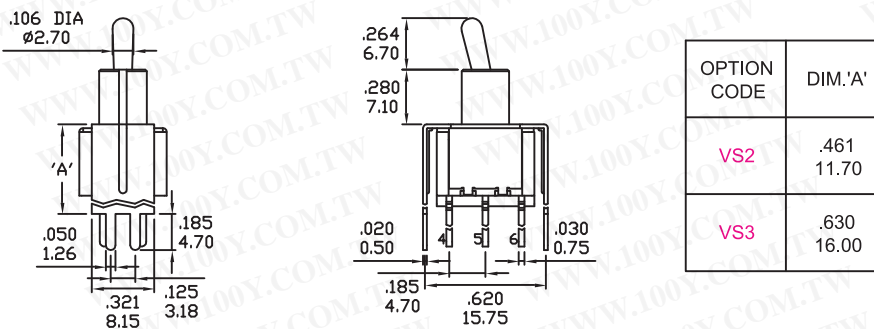

P.C.MOUNTING

VS4-VS5

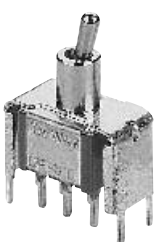

SPDT

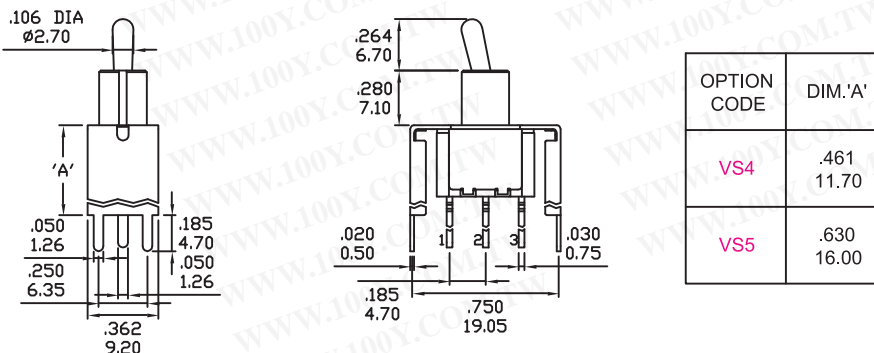

P.C.MOUNTING

TERMINATION OPTIONS

VS4-VS5

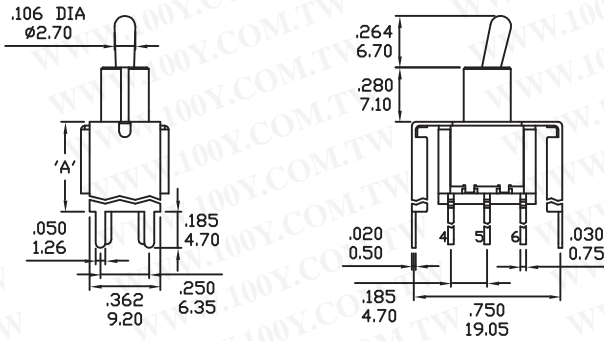

OPTION CODE	DIM.'A'
VS4	.461 11.70
VS5	.630 16.00

P.C.MOUNTING

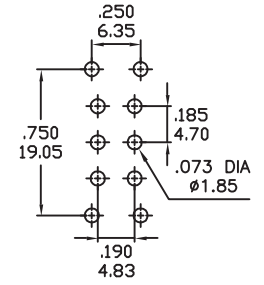

DPDT

SNAP-IN TERMINATION OPTIONS

M61 (AVAILABLE WITH SPDT AND DPDT)

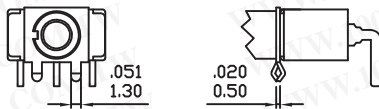

VS21,VS31

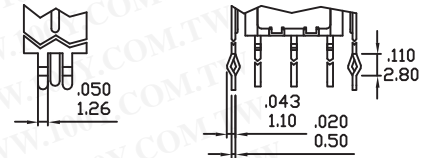

M71 (AVAILABLE WITH SPDT AND DPDT)

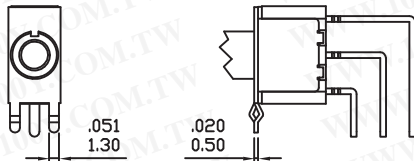

VS41,VS51

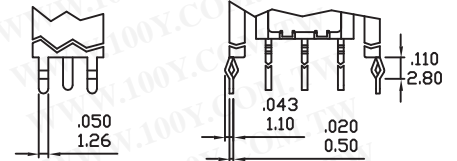

* PC Mounting for M61,M71,VS21,VS31,VS41,VS51 refer to M6,M7,VS2,VS3,VS4,VS5 respectively.

HARDWARE

NUT

STD. HDW2

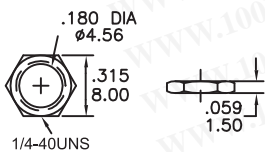

DRESS NUT HDW3

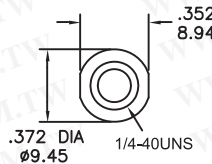

HDW4 - FOR T7,T8 ONLY

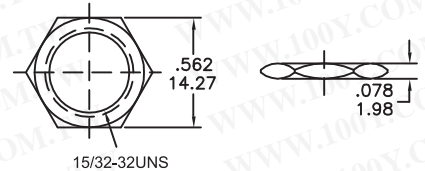

LOCKING RING

STD. HDW15

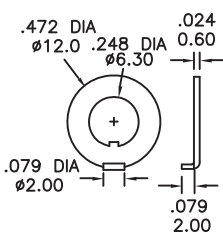

STD. HDW16

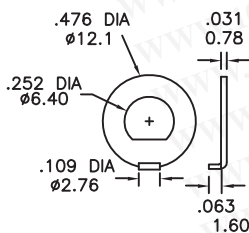

HDW17 - FOR T7,T8 ONLY

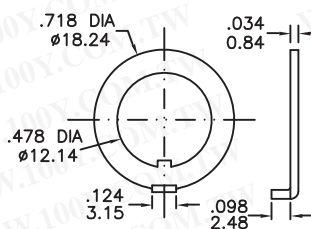

LOCK WASHER

STD. HDW11



HDW12 - FOR T7,T8 ONLY

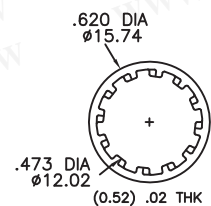

TOGGLE CAPS

T1 ACTUATOR CAP

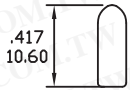

* MATERIAL: PVC.

T2 ACTUATOR CAP

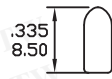

* MATERIAL: PVC.

T9 ACTUATOR GLOSS PLASTIC



* MATERIAL: ABS.

E1 RUBBER HOOD

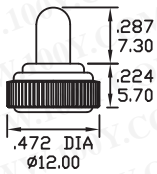

E1=INCH (STD.)
E1A=INCH WITH INTERNAL-ORING SEALED
K1=METRIC M6P0.75 THD (For B8 bushing only)

* FOR T1 ACTUATOR ONLY.

YE1A06 RUBBER HOOD

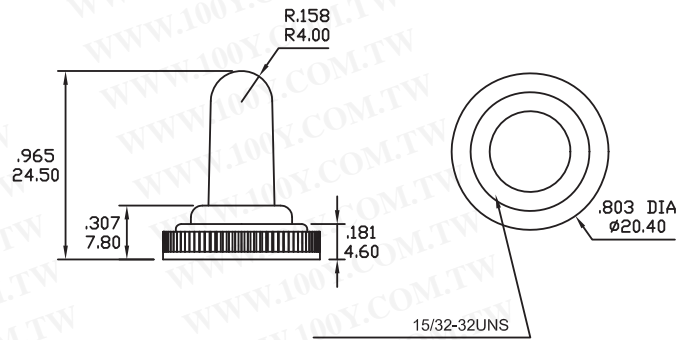

* FOR T8 ACTUATOR ONLY.

CONTACT MATERIAL OPTIONS

Coding	Contact Material	Terminal Plating	Rating	Agency Approvals
Q	Silver ¹	Silver plated ¹	5Amps @ 125VAC or 28VDC 2Amps @ 250VAC	
P		Tin plated ^{5, 7}		
R	Gold ²	Gold plated ⁴	0.4VA max @ 20V max (AC or DC)	
K		Tin plated ^{5, 6}		
G	Silver ¹	Gold over silver ³	5Amps @ 125VAC or 28VDC 2Amps @ 250VAC	

1. Movable Contact / Terminals: Copper alloy, silver plated.
2. Movable Contact: Copper alloy with gold plated over nickel plated.
3. Terminals: Silver plated with outer layer in gold plating.
4. Terminals: Copper alloy, with gold plated over nickel plated.
5. Outer Terminals: Copper alloy with pure tin plated.
6. Terminal Contact: Gold plated over nickel plated.
7. Terminal Contact: Palladium nickel alloy (or Silver) plated.

勝特力材料 886-3-5753170
 勝特力电子(上海) 86-21-34970699
 勝特力电子(深圳) 86-755-83298787
[Http://www.100y.com.tw](http://www.100y.com.tw)

* P, K not available with M1 and M3 terminals

* 6Amps (Movable Contact: coin silver, silver plated) available to model ON-NONE-ON without UL approval