



Power Contrls



Push Buttons

Selector Switches

Pilot Lights

勝特力材料 886-3-5753170
勝特力电子(上海) 86-21-34970699
勝特力电子(深圳) 86-755-83298787
[Http://www.100y.com.tw](http://www.100y.com.tw)

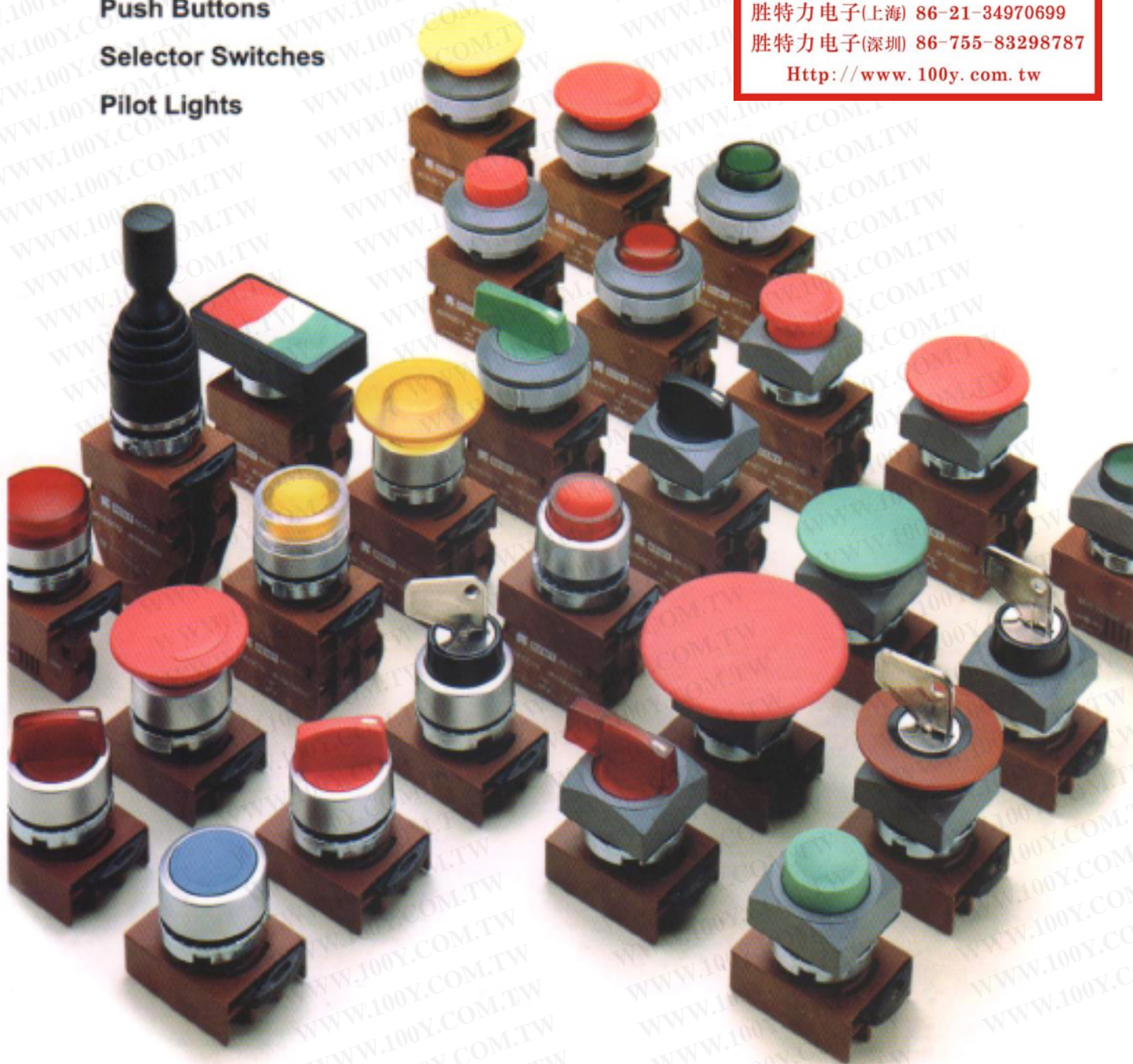

TYPE NUMBER NOMENCLATURE

- 安規標準** → 通過CSA認證及CE/EN60947-5-1, 標準
電氣容量 → 最大絕緣電壓 600VAC, 最大熱電流 10A
操作類別 → AC15類: 250VAC / 6A, DC13類: 250VDC / 0.6A
觸點導阻 → 最大50MΩ
絕緣強度 → 2500VAC 50Hz, 1分鐘
絕緣阻抗 → 500VDC下, 大於100MΩ
耐震阻值 → 10g @40~500Hz
用燈壽命 → 白熾燈 1,000小時, LED燈 100,000小時
機械壽命 → 按鈕開關: 瞬間 > 3,000,000 維持 > 500,000
 選擇開關: 瞬間 > 500,000 維持 > 500,000
 鑰匙開關: 瞬間 > 500,000 維持 > 500,000
 緊急開關: > 300,000
電氣壽命 → 開關片 AC15 250VAC / 6A > 1,000,000
 DC13 250VDC / 0.6A > 1,000,000
儲存溫度 → -40°C to 70°C
操作室溫 → -25°C to 70°C

尺寸		ø22	ø25	ø30
D	面板孔徑	22.5	25.5	30.5
A	標準頸部	45min	45min	45min
	長柄選擇	50	50	50
	二點照光按鈕	60	60	60
	ø60大頭按鈕	61	61	61
	十字開關	70	70	70
B	標準頸部(圓型、方型)	31 (51)	31 (51)	40 (51)
	長柄選擇	35 (51)	35 (51)	40 (51)
	二點式照光按鈕	31 (51)	31 (51)	31 (51)
	ø40大頭按鈕	41 (51)	41 (51)	41 (51)
	ø60大頭按鈕	61	61	61
	十字開關	70	70	70



形狀、材質、顏色

R9系列產品包含3種不同型式的組合
 圓形 22m/用尼龍加纖維及防火材料鍍銀鍍設計

圓形 30m/用灰色尼龍加纖維及防火材料

方圓形22m/用灰色尼龍加纖維及防火材料

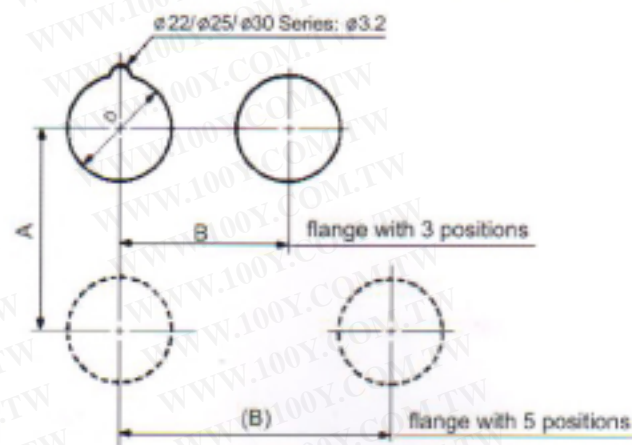
這優雅、現代、人性化的R9產品有多種顏色和款式可供選擇, 同時也是高級工業設計經驗的結晶。

安裝方式

R9生產線提供多種產品、接點、電源供應器

在“易組合”的方式下, 它們是全部可以相互交換的, 且由於創新的凸緣設計, 可使組裝的時間減到最少, 不僅滿足了特別的使用需求, 而且產品、接點及電源供應器可另選做為盒子安裝使用。

安裝和放在適當位置

根據IEC529, 所有的R9產品都裝有一個U型防水油封, 以確保能達到IP65等級防水、防油、防塵的標準, 在产品主體上有一個定位卡榫, 在鎖有鍵槽孔的面板上能給予正確的位置, 這卡榫也可確保配電盤的穩固, 在進行安裝及維護時能防止它旋轉, 面板若無鍵槽孔時, 可用一支一字螺絲起子把卡榫移除。

背後的鎖扣和背面的安裝程序

使用一種特別的工具(鎖環螺旋扳手)穿過鎖環, 將R9產品從背面安裝至配電盤上, 這些組件也可以用一支一字螺絲起子組裝。

快速的裝置

全部R9系列的背面設計, 是用插入扣上的, 保證安裝快速, 卸上凸緣的獨特設計能牢固的安裝在产品上, 如此可確保各部份能迅速的結合, 而對於盒子的安裝則是直接安裝在盒子內的卡座上。

每一個單一組件都能分別的組合或移開, 並不會妨礙其他部份, 在配電盤的安裝方面, 也可以將卸上凸緣所扣在一起之組件安裝或移開, 組件或凸緣能用一支標準的一字螺絲起子拆開, 進行簡單的維護操作。

勝特力材料 886-3-5753170
 勝特力电子(上海) 86-21-34970699
 勝特力电子(深圳) 86-755-83298787
[Http://www.100y.com.tw](http://www.100y.com.tw)

TYPE NUMBER NOMENCLATURE

1. 固定孔徑

R2 = 22φ Round
R3 = 30φ Round
R25 = 25φ Round
RS = 22φ 方圓型 Square

2. 型式

PNF = 平頭按鈕
PNH = 凸頭按鈕
PNM3 = 大頭30mm
PNM4 = 大頭40mm
PNM6 = 大頭60mm
PNR3 = 連鎖式30mm
PNR4 = 連鎖式40mm
PNR6 = 連鎖式60mm
PNKM4 = 連鎖式附鎖
PNP = 推拉式按鈕
PND = 雙頭式按鈕

3. 交替式

D = 交替式
 空白 = 無交替式

4. 接點

1A = 1A
1B = 1B
1C = 1A1B
1D = 1A+1B

5. 顏色

R = ● 紅
G = ● 綠
Y = ● 黃
W = ○ 白
B = ● 黑
BL = ● 藍

6. 印字

空白 = 不加印字
1 = 0
2 = 1



+



+



+



D-交替式

R2PNF

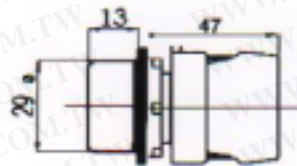

R3PNF



R2PNH

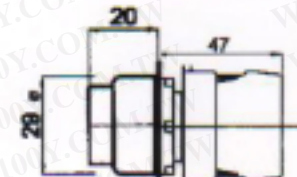

R3PNH

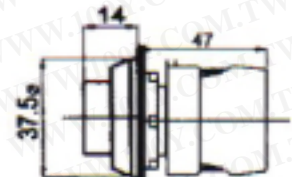

R2PNM3

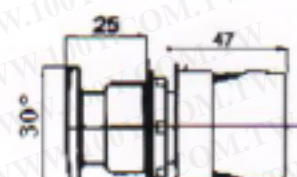

R3PNM3

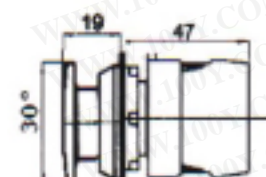

R2PNM4



R3PNM4

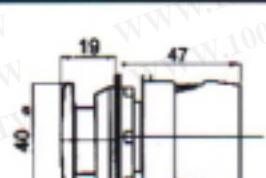

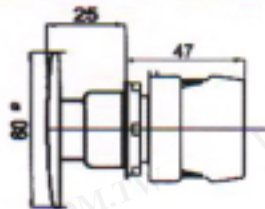
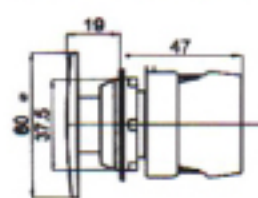
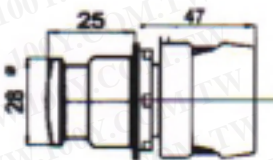
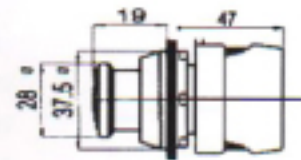
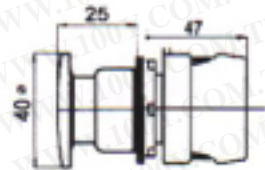
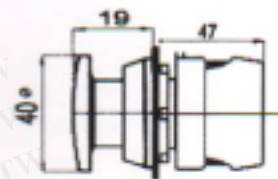
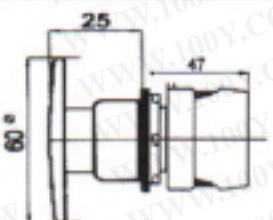
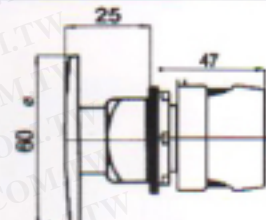
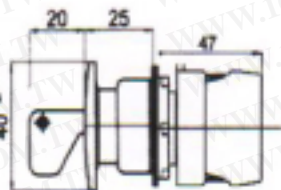
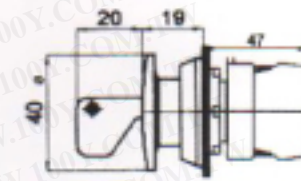
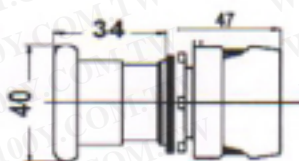
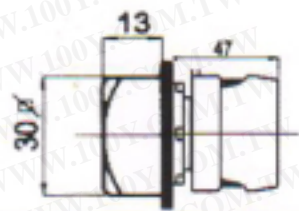
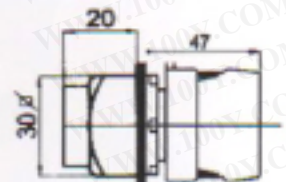
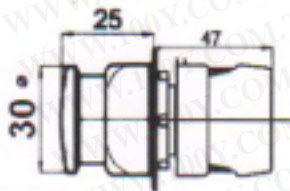
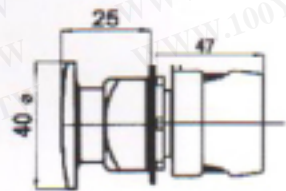
R2PNM6**R3PNM6****R2PNR3****R3PNR3****R2PNR4****R3PNR4****R2PNR6****R3PNR6****R2PNKM4****R3PNKM4****R2PNP****R2PND****RSPNF****RSPNH****RSPNM3****RSPNM4**

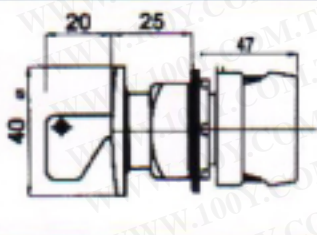
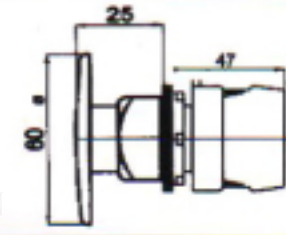
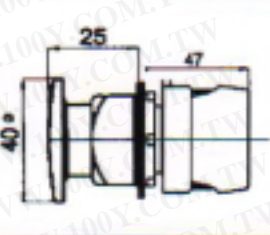
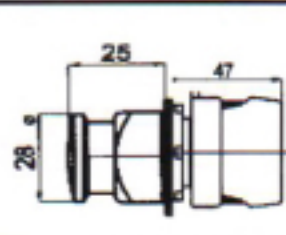
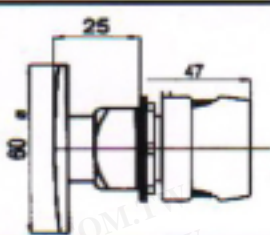

產品燈泡

IP65

TYPE NUMBER NOMENCLATURE

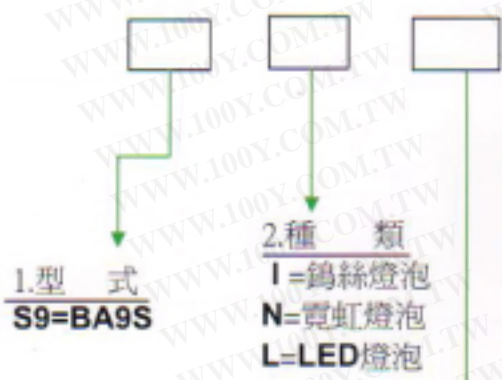

1. 型式
S9=BA9S

2. 種類
I=鎢絲燈泡
N=霓虹燈泡
L=LED燈泡

3. 電壓

- 1 = 110VAC (霓虹、LED)
- 2 = 220VAC (霓虹、LED)
- 3 = 380VAC (霓虹)
- 4 = 440VAC (霓虹)
- 5 = 6VAC/DC (鎢絲、LED)
- 6 = 18VAC/DC (鎢絲、LED)
- 7 = 24VAC/DC (鎢絲、LED)
- 8 = 30VAC/DC (鎢絲、LED)
- 9 = 12VAC/DC (鎢絲、LED)

4. 顏色
R = ● 紅
G = ● 綠
Y = ● 黃
W = ○ 白
BL = ● 藍

LED

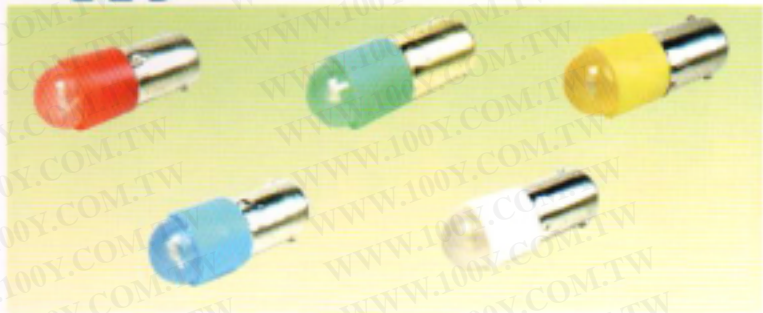

鎢絲

霓虹(紅)

霓虹(綠)

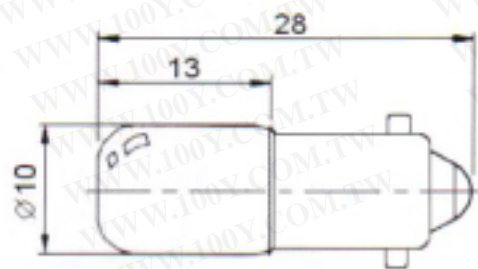

勝特力材料 886-3-5753170
 勝特力电子(上海) 86-21-34970699
 勝特力电子(深圳) 86-755-83298787
[Http://www.100y.com.tw](http://www.100y.com.tw)

TYPE NUMBER NOMENCLATURE

1. 固定孔徑

R2=22φ Round
 R3=30φ Round
 R25=25φ Round
 RS=22φ 方圓型 Square

3. 段落

2 = 2段
 3 = 3段

4. 段落型式

T= 複歸
 F= 保持

5. 動作方式

D= 60°角 · 兩邊均有接點
 E= 代表 0 在左邊
 R= 轉右邊45°角 或 右邊複歸
 L= 轉左邊45°角 或 左邊複歸
 B= 代表 0 在中間
 (如果是 T 複歸兩邊都可複歸)
 M= 代表沒 0 三段均有接點

6. 接點

1A=1A
 1B=1B
 1C=1A1B
 1D=1A+1B
 2A=2A

7. 顏色

R = ● 紅
 G = ● 綠
 Y = ● 黃
 B = ○ 黑
 BL = ● 藍

7. 抽取位置

★鎖匙 0 的位置
 一定是可抽
 ★複歸的那一邊
 一定不可抽

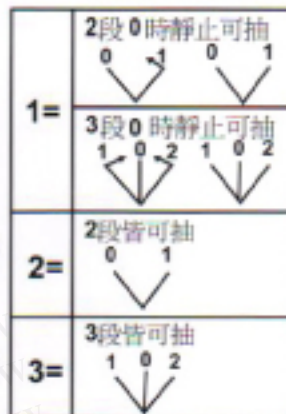
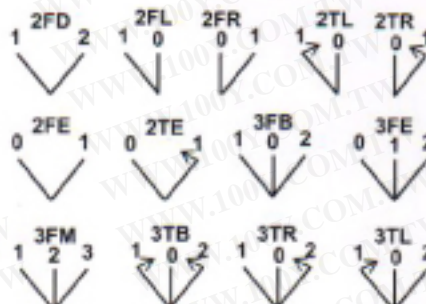

R2SNS



R3SNS

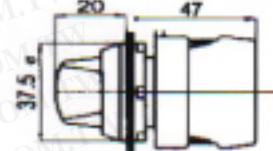

R2SNL



R3SNL

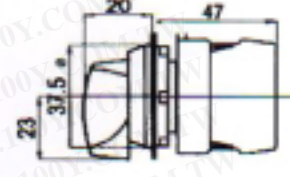

RSSNS

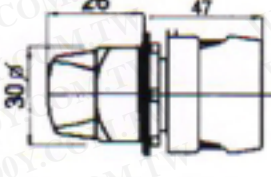

RSSNL

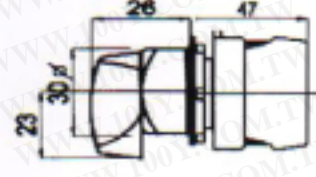

R2SNK

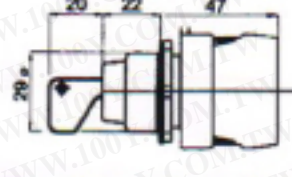

R3SNK

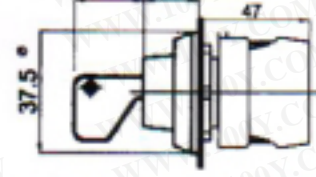

RSSNK

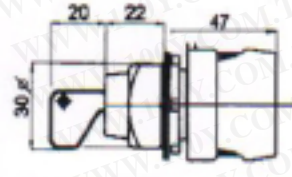

TYPE NUMBER NOMENCLATURE

1. 固定孔徑

R2=22 ϕ Round
R25=25 ϕ Round
R3=30 ϕ Round
RS=22 ϕ 方圓型
Square

2. 型式

PIF= 照光平頭附護圈
PIH= 照光凸頭
PIM4= 照光大頭
PID= 雙頭照光

3. 交替式

D = 交替式
空白=無交替式

4. 接點

1A=1A
1B=1B
1C=1A1B
1D=1A+1B
2A=2A

5. 電壓

1=110VAC (霓虹、LED燈泡)
2=220VAC (霓虹、LED燈泡)
3=380VAC (霓虹燈泡)
4=440VAC (霓虹燈泡)
5=6VAC/DC (鎢絲、LED燈泡)
6=18VAC/DC (鎢絲、LED燈泡)
7=24VAC/DC (鎢絲、LED燈泡)
8=30VAC/DC (鎢絲、LED燈泡)
9=12VAC/DC (鎢絲、LED燈泡)

6. 顏色

R = 紅
G = 綠
Y = 黃
W = 白
BL = 藍
O = 橘

8. 印字

空白=不加印字
1=0
2=1

7. 燈泡

I = 鎢絲燈泡
N = 霓虹燈泡
L = LED燈泡

R2PIF



R3PIF

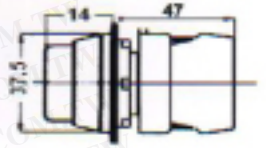

R2PIH

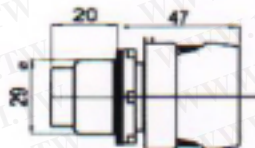

R3PIH

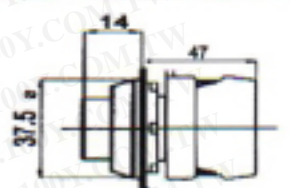

R2PIM4

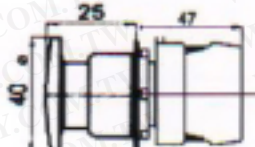

R3PIM4



R2PID

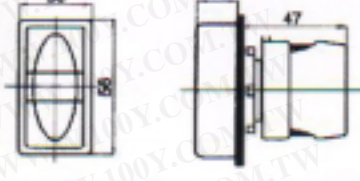

RSPIH



RSPIM4

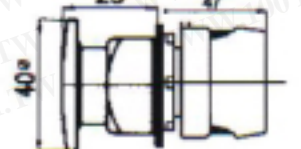

TYPE NUMBER NOMENCLATURE

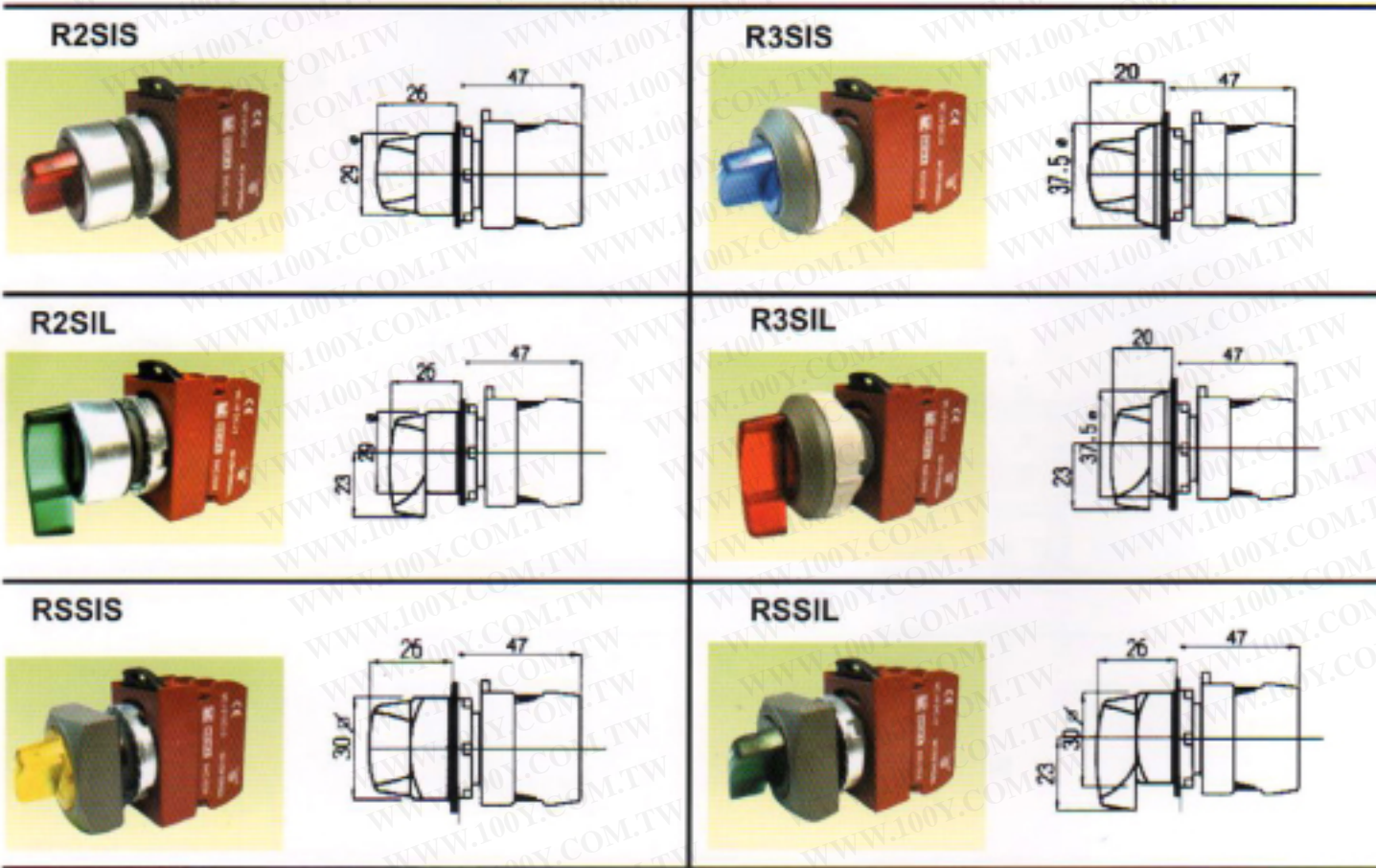
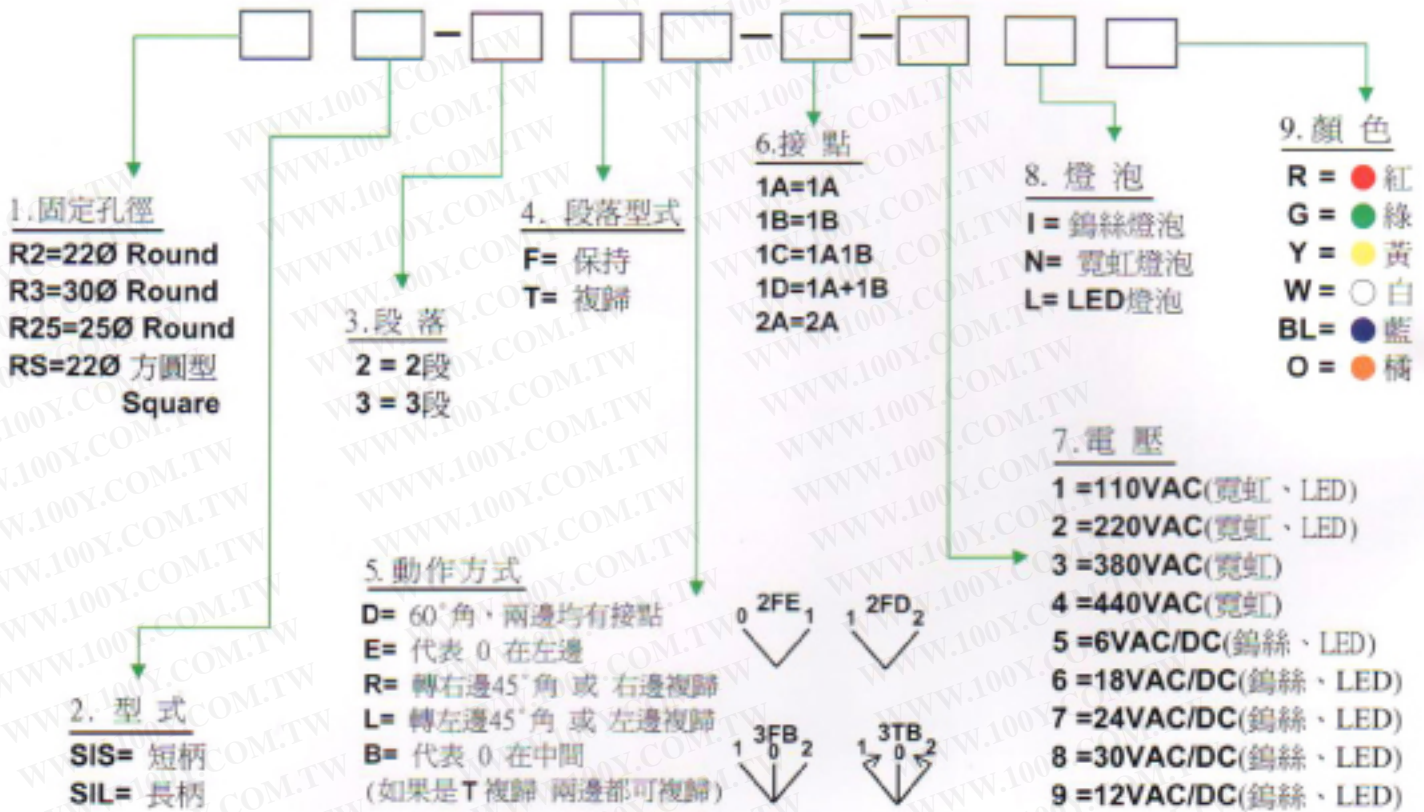

勝特力材料 886-3-5753170
 勝特力电子(上海) 86-21-34970699
 勝特力电子(深圳) 86-755-83298787
[Http://www.100y.com.tw](http://www.100y.com.tw)

TYPE NUMBER NOMENCLATURE

1. 固定孔徑

R2 = 22 ϕ Round
R25 = 25 ϕ Round
R3 = 30 ϕ Round
RS = 22 ϕ 方圓型 Square

2. 型式

LIF = 標準式平頭
LIH = 標準式凸頭
LUF = 簡單式平頭
LUH = 簡單式凸頭

3. 電壓

1 = 110VAC (霓虹 · LED)
2 = 220VAC (霓虹 · LED)
3 = 380VAC (霓虹)
4 = 440VAC (霓虹)
5 = 6VAC/DC (鎢絲 · LED)
6 = 18VAC/DC (鎢絲 · LED)
7 = 24VAC/DC (鎢絲 · LED)
8 = 30VAC/DC (鎢絲 · LED)
9 = 12VAC/DC (鎢絲 · LED)

4. 燈泡

I = 鎢絲燈泡
N = 霓虹燈泡
L = LED燈泡

5. 顏色

R = 紅
G = 綠
Y = 黃
W = 白
BL = 藍
O = 橘

Signalling unit (Normal)



Signalling unit (Simple)



R2LIF

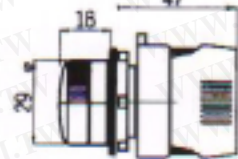

R3LIF



R2LIH

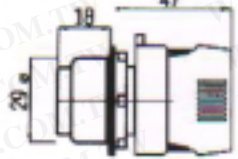

R3LIH

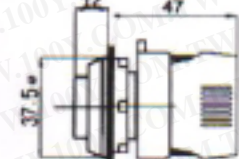

R2LUF

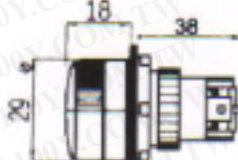

R3LUF

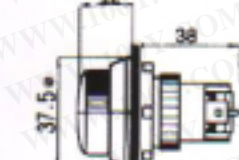

R2LUH

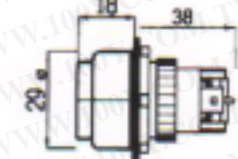

R3LUH

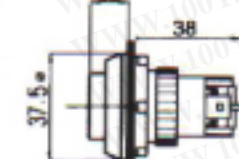

RSLUH

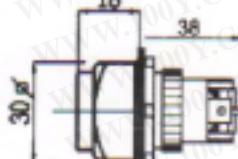

RSLIH





TYPE NUMBER NOMENCLATURE

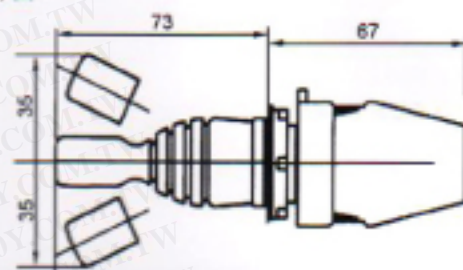
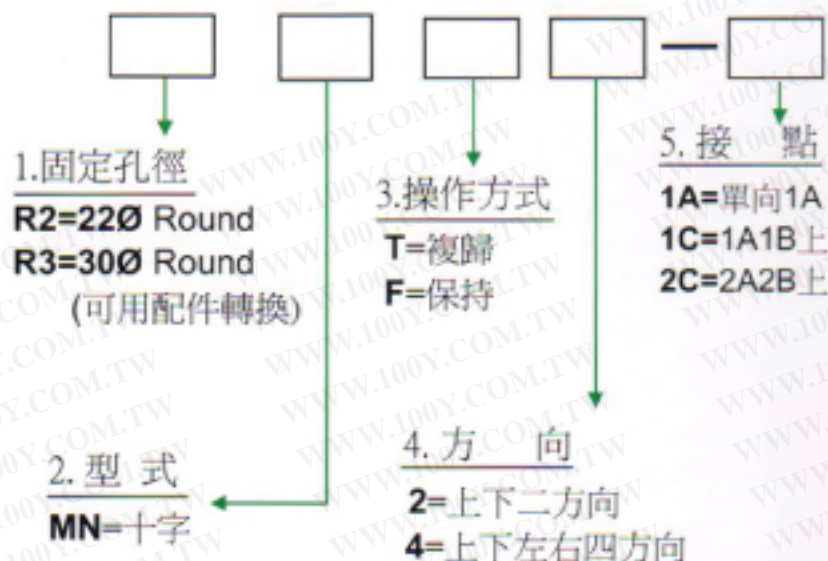

TYPE NUMBER NOMENCLATURE

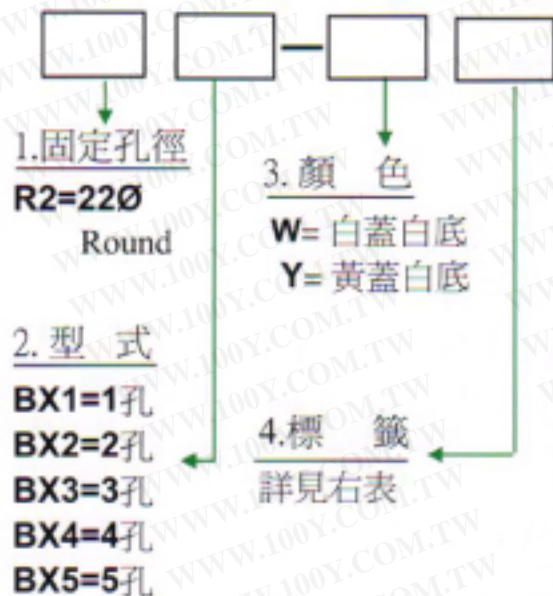

型式尺寸	A	B	C	D	E	F	HxLxØmax
BX1	65	70	63	52	24	21.5	53x38x4.5
BX2	100	70	63	52	24	21.5	88x38x4.5
BX3	140	70	63	52	24	21.5	128x38x4.5
BX4	178	70	63	52	24	21.5	167x38x4.5
BX5		70	63	52	24	21.5	

B-01	B-02
ON	OFF
B-03	B-04
ON OFF	ON OFF ON
B-05	B-06
STOP	START
B-07	B-08
EM.STOP	RESET

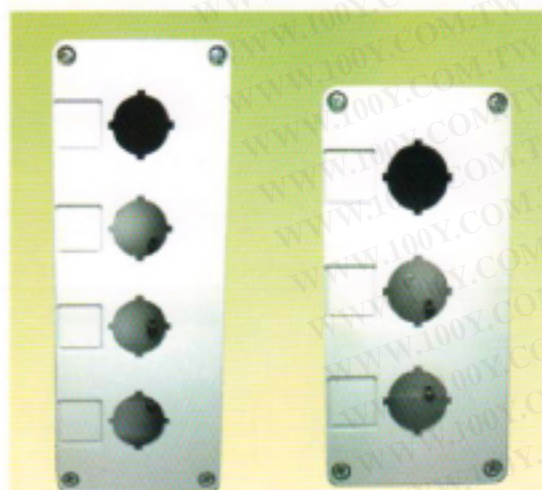
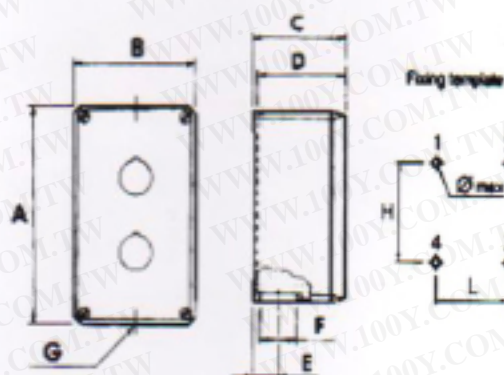

TYPE NUMBER NOMENCLATURE

Contact Blocks 接點組

接點圖

代號



• 3



• 4



NO

R9C10VN

• 1



• 2



NC

R9C01VN

• 3



• 4

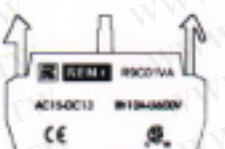

NO

R9C10VA

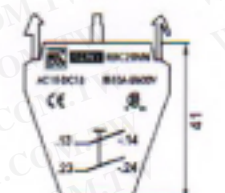

NO+NO

R9C20VN

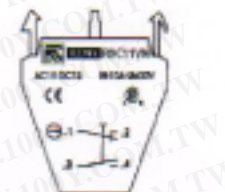

NO+NC

R9C11VN

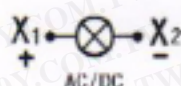

IEC:BA9S max 380V-2W

R9PDNVS

CSA:BA9S max 250V-2W

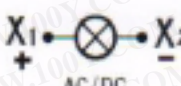

IEC:BA9S max 380V-2W

R9PDNVO

CSA:BA9S max 250V-2W

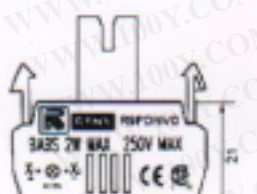

110 / 6V

R9PTNV1

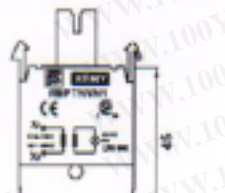

220 / 6V

R9PTNV2

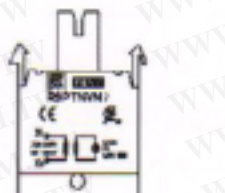



TYPE NUMBER NOMENCLATURE

Color Lens 色蓋	Type NO. 訂購代號	Fill in the color code in <input type="checkbox"/> (在 <input type="checkbox"/> 內填入顏色代號)	COMMON ACCESSORIES 配件
	R9LRGH <input type="checkbox"/> 代號	R.G.Y.W.BL	R9FRS-H
	R9PRGF <input type="checkbox"/> 代號	R.G.Y.W.BL	R9FRS-L
	R9LRGF <input type="checkbox"/> 代號	R.G.Y.W.BL	R9FRB-H
	R9PRGM4 <input type="checkbox"/> 代號	R.G.Y.BL	R9FRB-L
	R9PSGD <input type="checkbox"/> 代號	R.G.O.W Color : R.G.Y.O.W B.BL R=Red(紅) R=Green(綠)G Y=Yellow(黃)Y O=Orange(橘)O W=Whiet(白)W B=Black(黑)B BL=Blue(藍)BL	R9TRM2 20Ø固定牙環
	R9SRGS <input type="checkbox"/> 代號	R.G.Y.W.BL	R9TRP2 25Ø固定牙環
	R9SRGL <input type="checkbox"/> 代號	R.G.Y.W.BL	R9TRP3 30Ø固定牙環
	R9PRBF <input type="checkbox"/> 代號	R.G.Y. W.B.BL	R9ACFS3 3P四角卡座
	R9PRBH <input type="checkbox"/> 代號	R.G.Y.B.BL	R9ACFS5 5P四角卡座
	R9PRBM3 <input type="checkbox"/> 代號	R.G.Y.B.	R2PRCF 平頭押扣砂膠防塵蓋
	R9PRBM4 <input type="checkbox"/> 代號	R.G.Y.B.BL	R2PRCH 凸頭押扣 凸頭照光 砂膠防塵蓋 平頭照光
	R9PRBM6 <input type="checkbox"/> 代號	R.G	R2PRCD 雙頭押扣防塵蓋
	R9SRBS <input type="checkbox"/> 代號	R.G.Y.B.BL	R9GRCF PC平頭押扣保護蓋
	R9SRBL <input type="checkbox"/> 代號	R.G.Y.B.BL	R9GRM4 Ø40緊急開關保護蓋
	R9PRBP-0	色蓋及標示	R9ANK-1 -2 鎖柄 -3
	R9PRBP-1	色蓋及標示	R9TS 固定環工具把手



Power Controls

勝特力材料 886-3-5753170
 勝特力电子(上海) 86-21-34970699
 勝特力电子(深圳) 86-755-83298787
[Http://www.100y.com.tw](http://www.100y.com.tw)