

General Specifications

勝特力材料 886-8-5753170
 勝特力电子(上海) 86-21-34970699
 勝特力电子(深圳) 86-755-83298787
[Http://www.100y.com.tw](http://www.100y.com.tw)

Electrical Capacity (Resistive Load)

- For MRX:** 2A @ 125V AC or 1A @ 30V DC
For MRY: For MRY106G: 0.4VA maximum @ 28V AC/DC maximum
 (Applicable Range 0.1mA ~ 0.1A @ 20mV ~ 28V)
 Note: See Supplement Index to find explanation of operating range.
 For all other MRY models: 3A @ 125V AC or 2A @ 30V DC
For MRT: For MRT22: 10A @ 125V AC or 4A @ 30V DC
 For MRT23: 5A @ 125V AC or 3A @ 30V DC

Other Ratings

- Contact Resistance:** 10 milliohms maximum for MRX, MRY, & MRT; 20 milliohms maximum for MRY106G
Insulation Resistance: 100 megohms minimum @ 500V DC for MRX & MRY
 200 megohms minimum @ 500V DC for MRT
Dielectric Strength: 1,000V AC minimum for 1 minute minimum
Mechanical Life: 15,000 operations minimum
Electrical Life: 7,500 operations minimum
Range of Operating Torque: 0.03 ~ 0.15Nm for MRX; 0.02 ~ 0.10Nm for MRY; 0.02 ~ 0.05Nm for MRT
Contact Timing: Nonshorting (break-before-make)
 MRX: Self-cleaning, sliding contact; MRY: Rotary contactor dish; MRT: Butt contacts
Indexing: 45° for MRX; 60° for MRY; 120° for MRT22; 60° for MRT23

Materials & Finishes

- Shaft:** Brass with nickel plating
Stopper Plate: Steel with zinc plating for MRX & MRY
Bushing/Housing: Brass with nickel plating
Movable Contacts: Silver alloy for MRX & MRT; copper with silver plating for MRY106;
 copper with gold plating for MRY106G
End Contacts & Terminals: Silver alloy & copper with silver plating for MRX & MRT; silver alloy plus brass with silver plating
 for MRY106; silver alloy with gold plating for MRY106G
Common Contacts & Terminals: Copper with silver plating for MRX, MRY106 & MRT22; brass with gold plating for MRY106G;
 brass with silver plating for MRT23
Base: Phenolic resin

Environmental Data

- Operating Temperature Range:** -10°C through +70°C (+14°F through +158°F)
Humidity: 90 ~ 95% humidity for 96 hours @ 40°C (104°F)
Vibration: 10 ~ 55Hz with peak-to-peak amplitude of 1.5mm traversing the frequency range & returning in
 1 minute; 3 right angled directions for 2 hours
Shock: 50G (490m/s²) acceleration (tested in 3 right angled directions, with 3 shocks in each direction)

Installation

- Mounting Torque:** .686Nm (6.08 lb•in)
Cap Installation Force: 19.6 ~ 29.4N (4.41 ~ 6.61 lbf)
Soldering Time & Temperature: Manual Soldering: See Profile A in Supplement section.

Standards & Certifications

- UL:** File No. E44145
 MRT22 models recognized at 10A @ 125V AC; MRT23 models recognized at 5A @ 125V AC
 Add "/U" to end of part number to order UL mark on switch
 Add "/CUL" to end of part number to order cULus mark on switch

Distinctive Characteristics

Positive detent mechanism for distinct feel and audible feedback.

Metal bushing and housing construction increases durability.

Adjustable stopper plate allows 2-8 position settings.

High contact reliability achieved by the self-cleaning contact mechanism.

Break-before-make contact timing with various mechanism types: sliding contacts in MRX, contactor dish in MRY, and butt contacts in MRT models.

Terminal types include PC-turret for MRX, turret for MRY, and solder lug for MRT models.

Molded-in PC-turret and turret terminals prevent entry of flux and other contaminants.

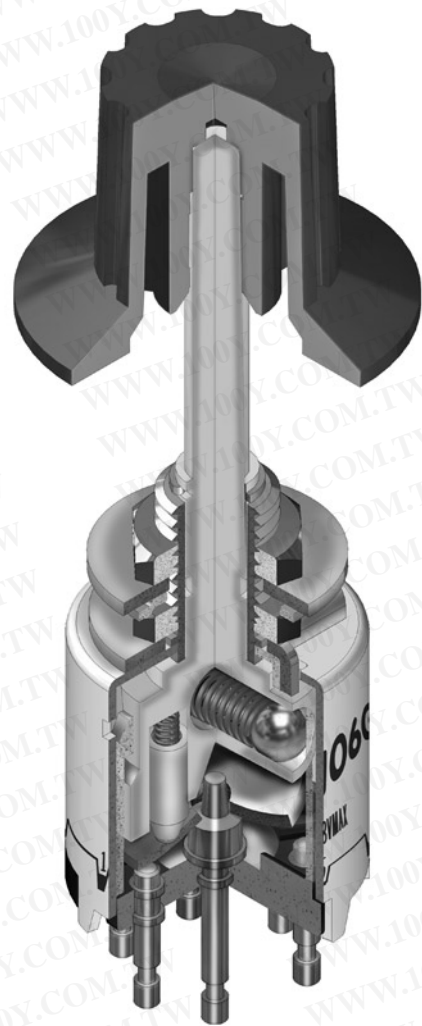

Actual Size

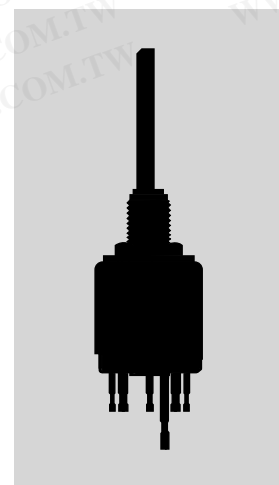

勝特力材料 886-3-5753170
 勝特力电子(上海) 86-21-34970699
 勝特力电子(深圳) 86-755-83298787
[Http://www.100y.com.tw](http://www.100y.com.tw)

- Rotaries
- Keylocks
- Programmable Illuminated PB
- Pushbuttons
- Rockers
- Toggles
- Slides
- Tactiles
- Tilt
- Touch
- Indicators
- Accessories
- Supplement

TYPICAL SWITCH ORDERING EXAMPLE

MR

X

108

A



Actuators & Terminals

X Shaft Actuated with PC-Turret Terminals

Y Shaft Actuated with Turret Terminals

T Shaft Actuated with Solder Lug Terminals *

Poles & Circuits

108 SP with 2-8 Positions
204 DP with 2-4 Positions
402 4P with 2 Positions

106 SP with 2-6 Positions
106G SP with 2-6 Positions Gold Contacts 0.4VA

22 DPDT ON-NONE-ON
23 DPDT ON-OFF-ON

Knobs

A Plain Black
B Small Color Tipped
C Large Color Tipped

Colors

For Plain Knob

No Code Black

For Color Tipped

A Black
B White
C Red
E Yellow
F Green
G Blue
H Gray

* Wire harness & cable assemblies offered only in Americas

DESCRIPTION FOR TYPICAL ORDERING EXAMPLE

MRX108-A

Shaft Actuated with Plain Black Knob

SP with 2-8 Adjustable Positions

PC-Turret Terminals



IMPORTANT:



MRT switches are supplied without UL or cULus marking unless specified. Specific models & ratings are noted on the General Specifications page.

勝特力材料 886-3-5753170
 勝特力电子(上海) 86-21-34970699
 勝特力电子(深圳) 86-755-83298787
[Http://www.100y.com.tw](http://www.100y.com.tw)

ACTUATORS & TERMINALS

X Shaft Actuated with PC-Turret Terminals

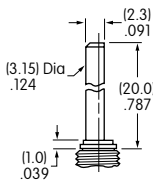
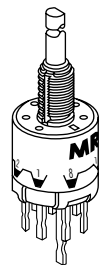

Shaft

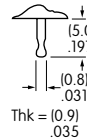

Terminal

Y Shaft Actuated with Turret Terminals

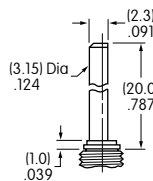
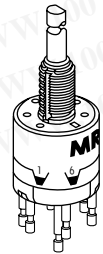

Shaft

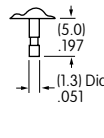

Terminal

T Shaft Actuated with Solder Lug Terminals

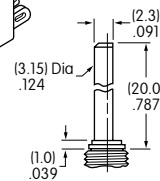
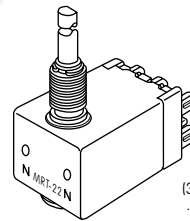

Shaft

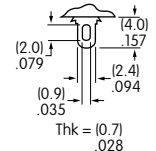

Terminal

POLES & CIRCUITS						
Pole	Model	Number of Positions	Stopper Settings	Number of Terminals	Schematics	
SP	MRX108	2-8	2, 3, 4, 5, 6, 7, 8	1 COM, 8 LOAD		
	MRY106 MRY106G	2-6	2, 3, 4, 5, 6	1 COM, 6 LOAD		
DP	MRX204	2-4	2, 3, 4	2 COM, 8 LOAD		
DPDT	MRT22	2	ON-NONE-ON	2-3 2-1 5-6 5-4		
	MRT23	3	ON-OFF-ON	2-3 OPEN 2-1 5-6 OPEN 5-4		
4P	MRX402	2	1 & 2	4 COM, 8 LOAD		

POSITION SETTING FOR MRX & MRY MODELS

Each switch is supplied with the stopper set for the maximum number of positions allowed for that model. Prior to installation, the desired position setting should be made. Contact factory for continuous rotation.

- Using the actuator knob, turn the shaft counterclockwise to the extreme left. If the shaft is not turned to this extreme position where the white line on the knob points to the number 1 position shown on the side of the switch, proper setting cannot be achieved.
- Remove the knob from the shaft and loosen the nut far enough to allow raising the stopper plate for resetting to the desired position.
- Note the position numbers on the side of the switch; these correspond to the terminal numbers and stopper holes. Insert the stopper in the hole numbered for the maximum desired number of stop settings. Satisfactory switch functioning cannot be assured if the stopper plate is not properly positioned.
- Tighten the nub (beveled side up) firmly against the stopper plate.

Mounting Hardware Packaged Loose with Each Switch

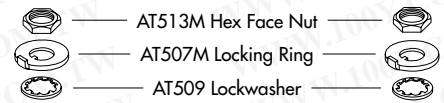

Factory Assembled:

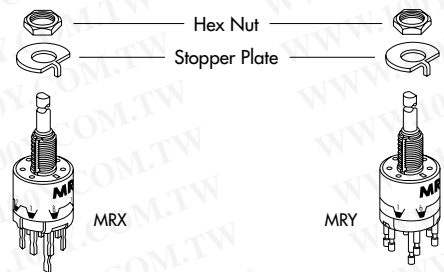

TYPICAL SWITCH DIMENSIONS

Single, Double & Four Pole

MRX • PC-Turret Terminals

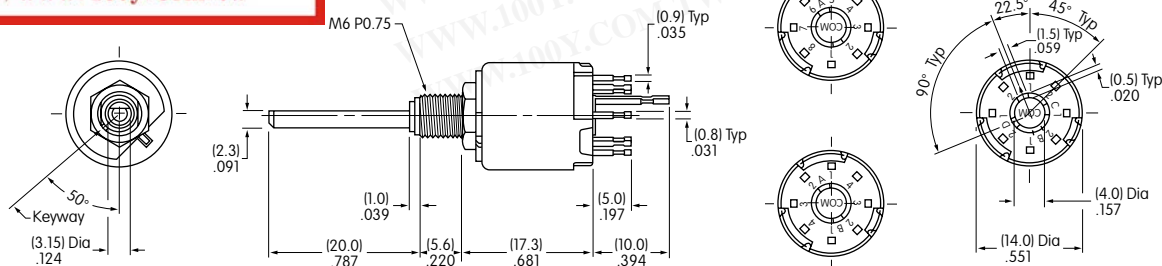

MRX108

勝特力材料 886-3-5753170
 勝特力电子(上海) 86-21-34970699
 勝特力电子(深圳) 86-755-83298787
[Http://www.100y.com.tw](http://www.100y.com.tw)

TYPICAL SWITCH DIMENSIONS

MRY • Turret Terminals

Single Pole

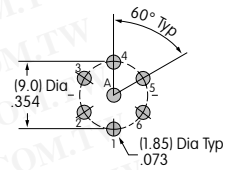
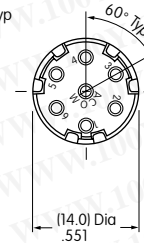
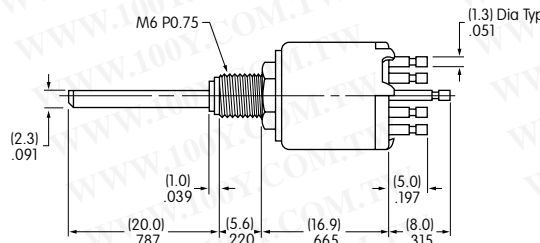
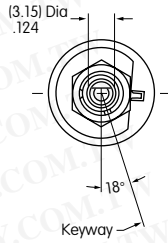

MRY106

MRT • Solder Lug Terminals

Double Pole

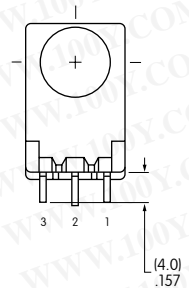
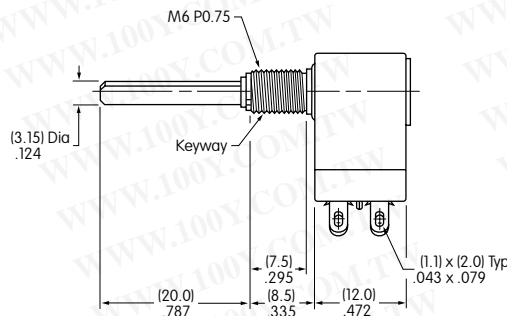
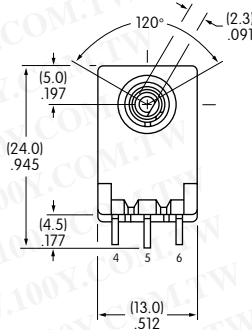
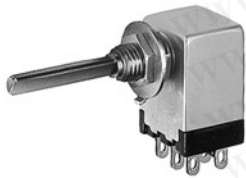

MRT22

PC FOOTPRINTS FOR MRX SINGLE, DOUBLE, & FOUR POLE

Single Pole

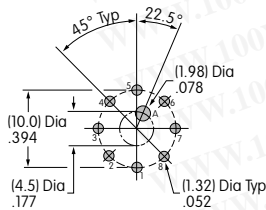

Double Pole

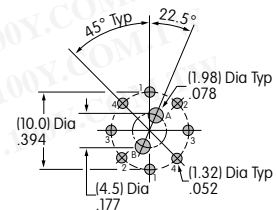

Four Pole

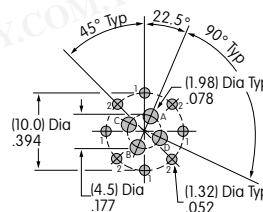

勝特力材料 886-3-5753170
 勝特力电子(上海) 86-21-34970699
 勝特力电子(深圳) 86-755-83298787
[Http://www.100y.com.tw](http://www.100y.com.tw)

KNOBS

A AT433 Plain Black

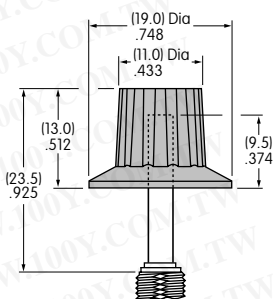

Material: Polyacetal

Color: Black only

B AT4103 Small Color Tipped

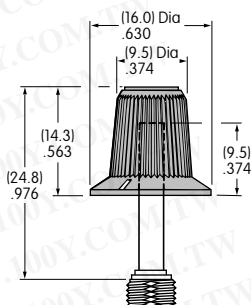

Base Material: Polyester

Base Color: Black

Polyamide Tip

Colors: A, B, C, E, F, G, H

C AT4104 Large Color Tipped

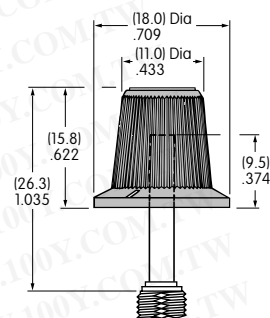

Base Material: Polyester

Base Color: Black

Polyamide Tip

Colors: A, B, C, E, F, G, H

Color Codes:



Black



White



Red



Yellow



Green



Blue



Gray

PANEL CUTOUTS & MAXIMUM EFFECTIVE PANEL THICKNESS

Without Keyway

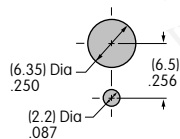

With Keyway

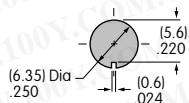

Maximum Effective Panel Thickness

With Standard Hardware: MRX & MRY .095" (2.4mm); MRT .106" (2.7mm)

Without Locking Ring: MRX & MRY .126" (3.2mm); MRT .138" (3.5mm)

勝特力材料 886-3-5753170
 勝特力电子(上海) 86-21-34970699
 勝特力电子(深圳) 86-755-83298787
[Http://www.100y.com.tw](http://www.100y.com.tw)