

MU022P/F11Z

自鎖型塑料帶燈按鈕開關

勝特力材料 886-3-5753170
 勝特力电子(上海) 86-21-34970699
 勝特力电子(深圳) 86-755-83298787
[Http://www.100y.com.tw](http://www.100y.com.tw)

安裝說明圖

MU022S/F11



頭部釋義 Head Type	F/平面 T/斜面 C/凹凸 H/高頭 B/球面 E/環形燈 D/中心燈 F/Flat T/Inclined C/Concave H/High B/Ball E/Ring lamp D/Center lamp		
外殼材料 Material	N/黃銅鍍鎳 A/鋅合金鍍鎳 S/不銹鋼/塑料 N/Chromium plated brass A/Zinc alloy plated chromium S/Stainless steel P/PC		
接線方式 Mode of connection	J/彈插式(1NO) 10/接線柱(1NO) 11/單刀(1NO,1NC) 22/雙刀(2NO,2NC) J/Pin terminal(1NO) 10/Wiring terminal(1NO) 11/Single pole(1NO, 1NC) 22/Double knife(2NO,2NC)		
額定電流 Rated Current	約5A About 5A	燈珠顏色 Head Color	R G Y O B W
安裝尺寸 Diameter	φ22mm	電壓等級 Voltage Rating	≤220V DC/AC 防護等級 IP Degree IP67 IK10

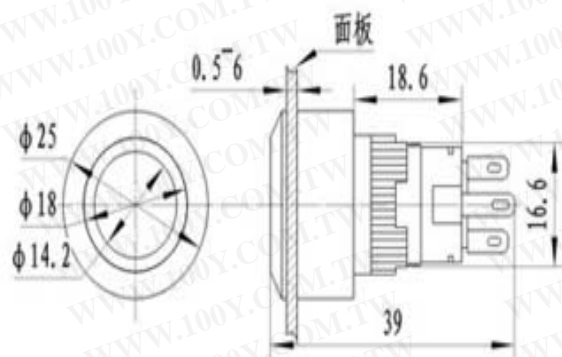

產品規格	Sepecification	MU022S/F11
保護等級	Degree of Protection	Ip67
觸點類型	Contact Type	1 NO 1NC / 2NO 2NC 可定制
最大電壓	Maximum Voltage	5V/250VAC
熱流	Thermal Current	5A
最小負載	Minimum Applicable Load	5V AC/DC, 1mA
觸點材料	Contact material	純銀合金Silver plated
端子形式	Terminal Style	.110" Solder/ Quick Connect
運行溫度	Operating Temperature	-25°C to +65°C
操作濕度	Operating Humidity	45 to 85% RH
接觸電阻	Contact Resistance	5mΩ maximum
絕緣電阻	Insulation Resistance	1000MΩ minimum (500V DC megger)
震蕩電阻	Vibration Resistance	10 to 55Hz, amplitude 1.2mm p-p
保護等級	Degree of Protection	>10g
電氣壽命	Electrical Life	200,000 operations minimum (at full rated load)
機械壽命	Mechanical Life	Maintained: 1000000 Momentary: 1000000 Selector/Keylock: 250000
耐壓	Dielectrical Life	Illumination Unit: 2,000V AC, 1 min. Between live part/ground
錫焊溫度	Soldering Temperature	20W/5 seconds or 260°C/3 seconds

产品说明

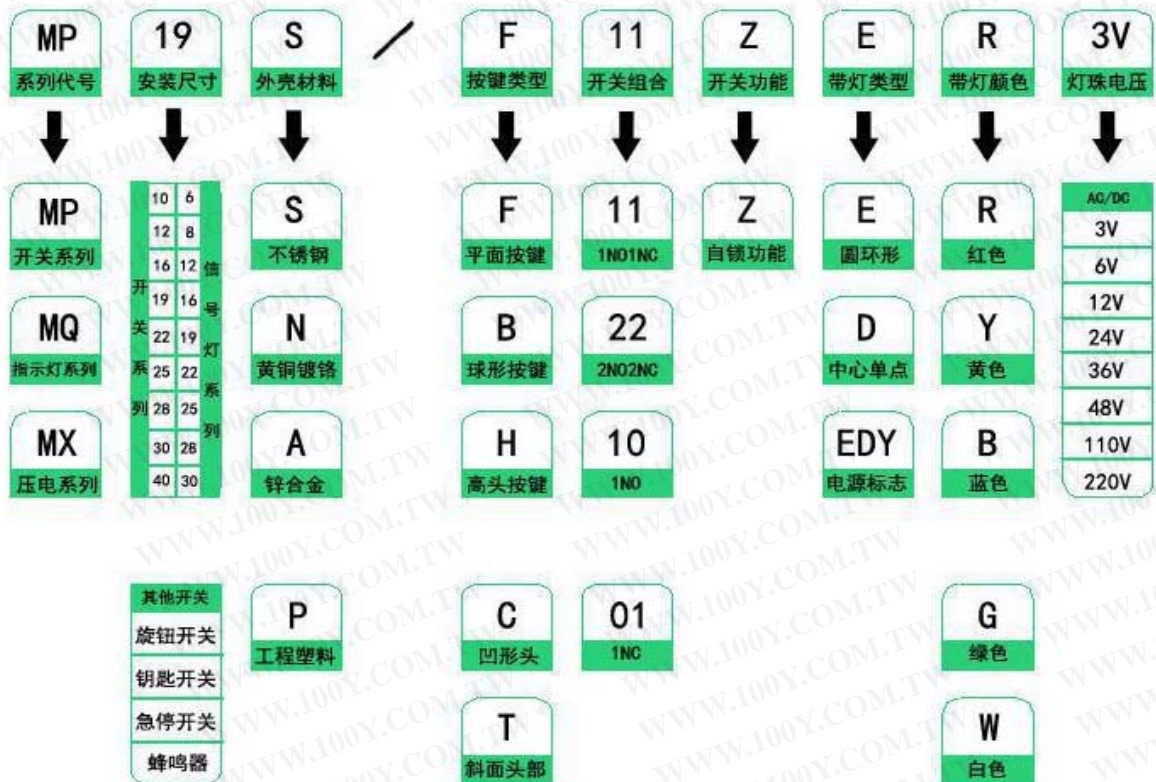





★ 事例解释MP19S/F11Z-E/R-3V表示开关系列19MM不锈钢平面一常开一常闭组合圆环形自锁带灯，电压3V的按钮开关。

★ 请仔细阅读产品说明，根据说明选择所需型号产品。

开关结构

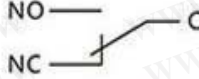

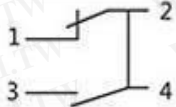
结构型式	示意图	符号	说明
1NO			具有两个端子的双断点慢动触头开关
1NO1NC			具有三个端子的单断点快动转换触头开关
1NO1NC			具有四个端子的双断点快动转换触头开关

胜特力材料 886-3-5753170
胜特力电子(上海) 86-21-34970699
胜特力电子(深圳) 86-755-83298787
[Http://www.100y.com.tw](http://www.100y.com.tw)