

Ø22mm

# YW Series Switches & Pilot Lights

勝特力材料 886-3-5753170  
勝特力电子(上海) 86-21-34970699  
勝特力电子(深圳) 86-755-83298787  
[Http://www.100y.com.tw](http://www.100y.com.tw)



# Innovative Design, Space-Saving, Safety, and Self-Cleaning Contacts

## Emergency Stop Switches

### Satisfy International Standards

- Safety Lock Mechanism

When the emergency stop signal has been generated during actuation of the emergency stop device, the emergency stop function shall be maintained until the emergency stop device is reset (disengaged) (IEC 60947-5-5, 6.2).

- Direct Opening Action

Even if the contacts are welded, NC contacts are forced to open and break the circuit (compliant to IEC 60947-5-1, Annex K, IEC 60947-5-5, 5.2).

- Safe Pushbutton Design

The pushbutton is designed to ensure that an object cannot become trapped between the mushroom button and the panel, disabling the button operation. In addition, the pushbutton is designed to prevent removal from the front of the panel (IEC 60947-5-5, 6.3.2).



### Easy Operation

- Push-to-lock, Pull/Turn-to-release

YW emergency stop switches can be unlatched by either pulling or turning the operator.

Unlatching by pulling



Unlatching by turning



## Unibody Pilot Lights

### Higher Brightness

Unibody pilot lights achieve high brightness.

### Short Depth behind the Panel

Measures only 42mm depth behind the panel.

### Four Lens Shapes

Flush, flush with marking, extended, and dome.

### Panel Mounting

Unibody pilot lights can be mounted on panels by tightening the locking ring.



## Key Selector Switches

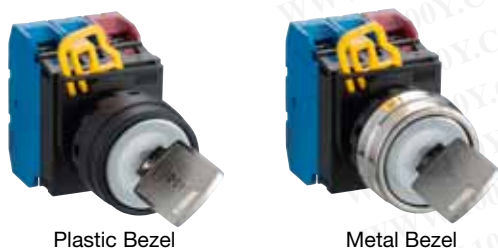

A variety of operations, key removal positions, and circuits.

Wide range adds more options to choose from.



# Safety

**Integrated Finger-safe Terminal Cover**  
**Degree of Protection: IP20**  
**(From panel front: IP65)**

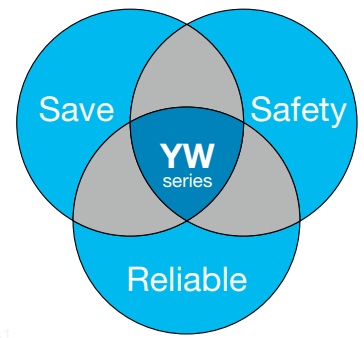

# Save

**New Contact Block Design**  
**YW series**

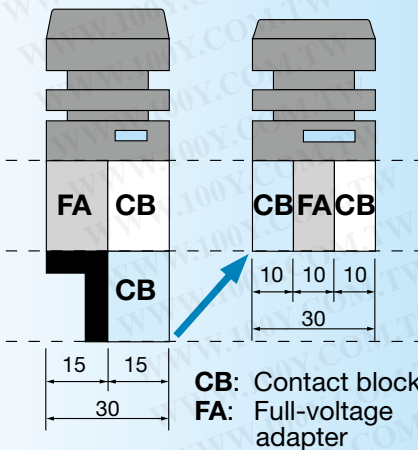

The contact block design reduces the depth behind the panel.



Metal bezels are available for pushbuttons, illuminated pushbuttons, selector switches, and key selector switches.



# Reliable

## Retained Locking Lever

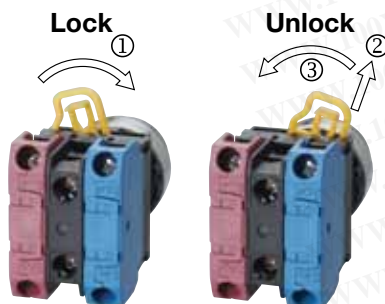

An innovative plastic locking lever is retained and eliminates the need for a separate lever lock.

## Heavy-Duty Rugged Construction

## Self-Cleaning Wiping-Action Contacts with Scored Contact Surfaces

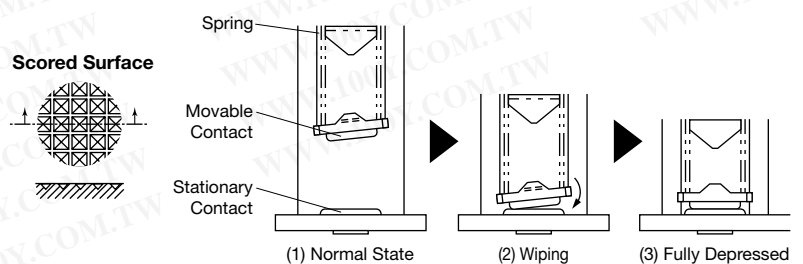

# YW Series Switches & Pilot Lights

**Space-saving, 10-mm-thick contact blocks. Removable operator.**

- Compact and light-weight
- IP20 finger-safe screw terminals (IEC 60529)
- Emergency stop switches feature safety lock mechanism, direct opening action, and safe pushbutton design.
- Separate contact block makes installation and removal easy. Pilot lights feature a large lens for a wide viewing angle.
- Matted surfaces on the buttons, lenses, and bezels reduce reflection of ambient light.
- UL, c-UL listed, EN compliant, and CCC approved.



- UL508, CSA C22.2 No. 14, EN 60947-1, EN 60947-5-1, EN 60947-5-5, GB 14048.5



## Contact Ratings (Contact Block)

Rated Insulation Voltage		600V			
Rated Thermal Current		10A			
Operating Voltage		24V	120V	240V	380V
AC 50/60 Hz	Resistive Load (AC-12)	10A	10A	6A	2A
	Inductive Load (AC-15)	10A	6A	3A	1.9A
DC	Resistive Load (DC-12)	8A	2.2A	1.1A	–
	Inductive Load (DC-13)	4A	1.1A	0.55A	–

## LED Illuminated Unit Specifications

### Pilot Light (removable lamp terminal type)

#### Illuminated Pushbutton

Unit				LED Lamp				
Unit Type	Input Type	Operating Voltage	Color Code	Lamp Base	Part No.	Rated Voltage	Current Draw	Color
Pilot Light (removable lamp terminal type)	Full Voltage	6V AC/DC	A: amber G: green PW: pure white R: red S: blue W: white (Note) Y: yellow	BA9S/13	LSED-6⊙	6V AC/DC	10mA (A, R, Y) 7mA (G, PW, S)	A: amber G: green PW: pure white R: red S: blue Y: yellow
		12V AC/DC			LSED-1⊙	12V AC/DC	14mA (A, R, Y) 13mA (G, PW, S)	
		24V AC/DC			LSED-2⊙	24V AC/DC	14mA (A, R, Y) 13mA (G, PW, S)	
		110V AC/DC			LSED-H⊙	110/120V AC/DC	5mA	
230/240V AC/DC	LSED-M3⊙	230/240V AC/DC			3mA			
100/110V AC								
Illuminated Pushbutton	Transformer (pilot light only)	200/220V AC		LSED-6⊙	6V AC/DC	10mA (A, R, Y) 7mA (G, PW, S)		
		115/120V AC						
		230/240V AC						

Note: Yellow LED lamps are used for white illumination.

### Pilot Light (unibody type)

Unit Type	Operating Voltage	Current Draw	Color Code
Pilot Light (unibody type)	6V AC/DC	16mA (A, R, W, Y) 13mA (G, PW, S)	A: amber G: green PW: pure white R: red S: blue W: white Y: yellow
	12V AC/DC	20mA	
	24V AC/DC	20mA	
	110V AC/DC	20mA	
	230/240V AC/DC	20mA	

## Incandescent Illuminated Unit Specifications

### Pilot Light (removable lamp terminal type)

#### Illuminated Pushbutton

Unit				LED Lamp			
Unit Type	Input Type	Operating Voltage	Color Code	Lamp Base	Part No.	Rating	
(Pilot Light (removable lamp terminal type)	Full Voltage	6V AC/DC	A: amber G: green R: red S: blue W: white Y: yellow	BA9S/13	LS-T6	1W (6.3V)	
		12V AC/DC			LS-T8	1W (18V)	
		24V AC/DC			LS-T3	1W (30V)	
		100/110V AC					
Illuminated Pushbutton	Transformer (pilot light only)	200/220V AC				LS-T6	1W (6.3V)
		115/120V AC					
		230/240V AC					

## Specifications

Operating Conditions	Operating temperature: -20 to +55°C (no freezing) Operating humidity: 45 to 85% RH (no condensation) Storage temperature: -45 to +80°C Storage humidity: 95% RH maximum
Degree of Protection	From panel front: IP65 (IEC 60529) Terminal: IP20 (IEC 60529)
Insulation Resistance	100 MΩ
Dielectric Strength	Contact block: 2,500V, 1 minute Pilot light: 2,000V, 1 minute
Vibration Resistance	<Emergency stop switch> Operating extremes / Damage limits: 10 to 500 Hz, amplitude 0.35 mm, acceleration 50 m/s <sup>2</sup> (5G) <Pushbutton, pilot light, illuminated pushbutton, selector switch, and key selector switch> Operating extremes: 5 to 55 Hz, amplitude 0.5 mm Damage limits: 30 Hz, amplitude 1.5 mm
Shock Resistance	<Emergency stop switch> Operating extremes: 150 m/s <sup>2</sup> (10G) Damage limits: 1,000 m/s <sup>2</sup> (100G) <Pushbutton, pilot light, illuminated pushbutton, selector switch, and key selector switch> Operating extremes: 100 m/s <sup>2</sup> (10G) Damage limits: 1,000 m/s <sup>2</sup> (100G)
Mechanical Life (minimum operations)	<Emergency stop switch> 250,000 (single contact block) <Pushbutton and illuminated pushbutton> Momentary: 5,000,000 (single contact block) 1,000,000 (double contact block) Maintained: 250,000 (single contact block) 100,000 (double contact block) <Selector switch and key selector switch> 250,000 (single contact block) 100,000 (double contact block)
Electrical Life (minimum operations)	<Emergency stop switch> 100,000 (single contact block) <Pushbutton, selector switch, and key selector switch> 100,000 (single contact block) 50,000 (double contact block)

## Mounting Hole Layout

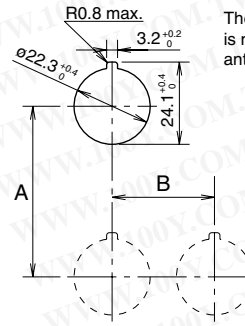

The 3.2-mm-wide key recess is necessary when the anti-rotation ring is used.

Unit	A (mm)	B (mm)
Emergency stop switch	50 min.	50 min.
Pushbutton Selector switch Key selector switch	50 min.	30 min.
Mushroom pushbutton	50 min.	40 min.
Pilot light (with removable lamp terminal)	30 min.*	30 min.
Pilot light (unibody)	50 min.	30 min.

\* Keep a minimum spacing of 50 mm when using a lamp of over 1W.

# ø22 YW Series Emergency Stop Switches

## Emergency Stop Switches (Pushlock Pull/Turn Reset)

Package Quantity: 1

Style	Contact	Contact Block Mounting Position			Part No.	Button Color Code
		1	2	3		
 ø40mm Mushroom	1NC	—	—	NC	<b>YW1B-V4E01R</b>	Red only
	2NC	NC	—	NC	<b>YW1B-V4E02R</b>	
	3NC	NC	NC	NC	<b>YW1B-V4E03R</b>	
	1NO-1NC	NO	—	NC	<b>YW1B-V4E11R</b>	
	1NO-2NC	NO	NC	NC	<b>YW1B-V4E12R</b>	
	2NO-1NC	NO	NC	NO	<b>YW1B-V4E21R</b>	

- When pressed, the button is locked in the depressed position, and is reset when either pulled or turned clockwise.

### Dimensions

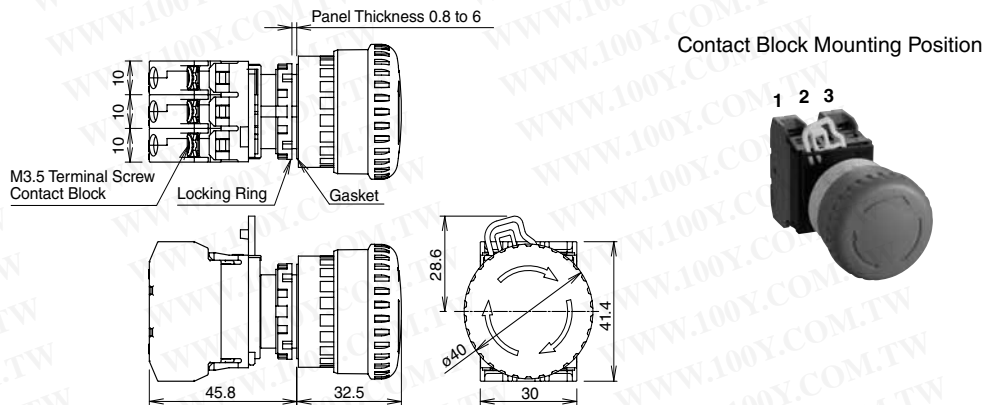

## Illuminated Emergency Stop Switches (Pushlock Pull/Turn Reset)

Package Quantity: 1

Style	Lamp	Contacts	Contact Block Mounting Position			Part No.	③ Operating Voltage Code	Lens Color Code
			1	2	3			
 ø40mm Mushroom	Without Lamp	1NC	—	FA	NC	<b>YW1L-V4E01Q0R</b>	0: without lamp 250V AC/DC max.	Red only
		2NC	NC	FA	NC	<b>YW1L-V4E02Q0R</b>		
		1NO-1NC	NO	FA	NC	<b>YW1L-V4E11Q0R</b>		
	LED	1NC	—	FA	NC	<b>YW1L-V4E01Q③R</b>	2: 6V AC/DC 3: 12V AC/DC 4: 24V AC/DC H: 110V AC/DC M3: 230/240V AC/DC	
		2NC	NC	FA	NC	<b>YW1L-V4E02Q③R</b>		
		1NO-1NC	NO	FA	NC	<b>YW1L-V4E11Q③R</b>		
	Incandescent	1NC	—	FA	NC	<b>YW1L-V4E01Q③R</b>	5: 6V AC/DC 6: 12V AC/DC 7: 24V AC/DC	
		2NC	NC	FA	NC	<b>YW1L-V4E02Q③R</b>		
		1NO-1NC	NO	FA	NC	<b>YW1L-V4E11Q③R</b>		

- Specify an operating voltage code in place of ③ in the Part No.
- When pressed, the button is locked in the depressed position, and is reset when either pulled or turned clockwise.





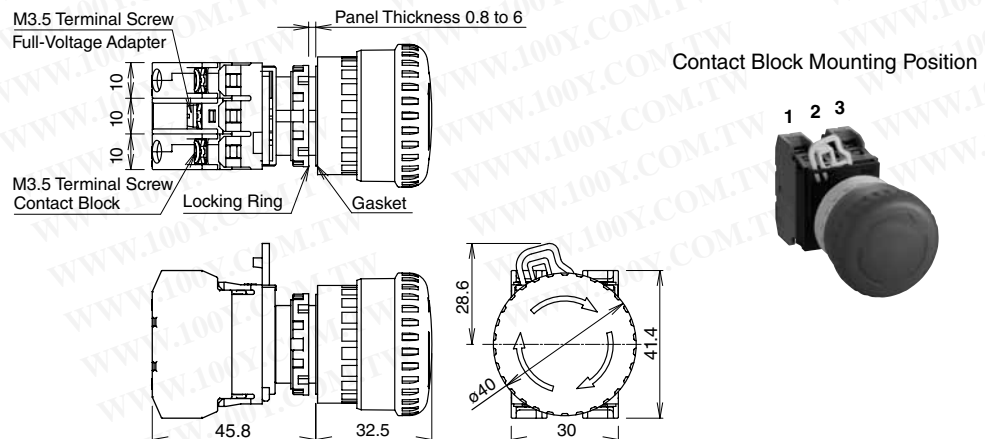

FA: Full voltage adapter

### Dimensions



## Pushbuttons with Plastic Bezel

Package Quantity: 1

Shape	Operation	Contact	Contact Block Mounting Position			Part No.	① Button Color Code			
			1	2	3					
 	Momentary	1NO	NO	—	—	YW1B-M1E10①	B: black G: green R: red S: blue W: white Y: yellow			
		1NC	—	—	NC	YW1B-M1E01①				
		2NO	NO	—	NO	YW1B-M1E20①				
		2NC	NC	—	NC	YW1B-M1E02①				
		1NO-1NC	NO	—	NC	YW1B-M1E11①				
		3NO	NO	NO	NO	YW1B-M1E30①				
		3NC	NC	NC	NC	YW1B-M1E03①				
	Maintained	2NO-1NC	NO	NC	NO	YW1B-M1E21①				
		1NO-2NC	NO	NC	NC	YW1B-M1E12①				
		1NO	NO	—	—	YW1B-A1E10①				
		1NC	—	—	NC	YW1B-A1E01①				
		2NO	NO	—	NO	YW1B-A1E20①				
		2NC	NC	—	NC	YW1B-A1E02①				
		1NO-1NC	NO	—	NC	YW1B-A1E11①				
 	Momentary	1NO	NO	—	—	YW1B-M2E10①	B: black G: green R: red S: blue W: white Y: yellow			
		1NC	—	—	NC	YW1B-M2E01①				
		2NO	NO	—	NO	YW1B-M2E20①				
		2NC	NC	—	NC	YW1B-M2E02①				
	Maintained	1NO-1NC	NO	—	NC	YW1B-M2E11①				
		1NO	NO	—	—	YW1B-A2E10①				
		1NC	—	—	NC	YW1B-A2E01①				
		2NO	NO	—	NO	YW1B-A2E20①				
		2NC	NC	—	NC	YW1B-A2E02①				
		1NO-1NC	NO	—	NC	YW1B-A2E11①				
		 	Momentary	1NO	NO	—		—	YW1B-M4E10①	B: black G: green R: red S: blue W: white Y: yellow
				1NC	—	—		NC	YW1B-M4E01①	
				2NO	NO	—		NO	YW1B-M4E20①	
				2NC	NC	—		NC	YW1B-M4E02①	
Maintained	1NO-1NC		NO	—	NC	YW1B-M4E11①				
	1NO		NO	—	—	YW1B-A4E10①				
	1NC		—	—	NC	YW1B-A4E01①				
	2NO		NO	—	NO	YW1B-A4E20①				
	2NC		NC	—	NC	YW1B-A4E02①				
	1NO-1NC		NO	—	NC	YW1B-A4E11①				

Note: Specify a button color code in place of ① in the Part No.

### Dimensions

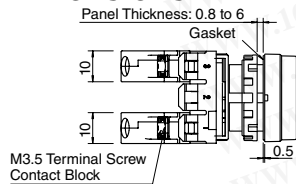

Contact Block Mounting Position

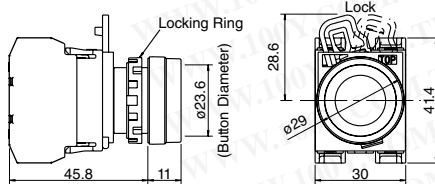
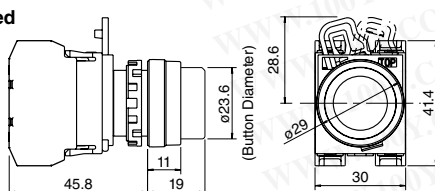
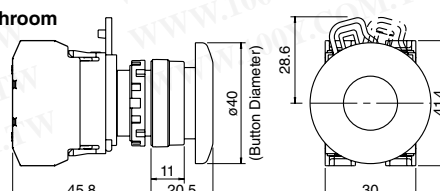





**Flush**

**Extended**

**Mushroom**

All dimensions in mm.

# ø22 YW Series Pushbuttons

## Pushbuttons with Metal Bezel

Package Quantity: 1

Shape	Operation	Contact	Contact Block Mounting Position			Part No.	① Button Color Code			
			1	2	3					
 	Momentary	1NO	NO	—	—	YW4B-M1E10①	B: black G: green R: red S: blue W: white Y: yellow			
		1NC	—	—	NC	YW4B-M1E01①				
		2NO	NO	—	NO	YW4B-M1E20①				
		2NC	NC	—	NC	YW4B-M1E02①				
		1NO-1NC	NO	—	NC	YW4B-M1E11①				
		3NO	NO	NO	NO	YW4B-M1E30①				
		3NC	NC	NC	NC	YW4B-M1E03①				
	Maintained	2NO-1NC	NO	NC	NO	YW4B-M1E21①				
		1NO-2NC	NO	NC	NC	YW4B-M1E12①				
		1NO	NO	—	—	YW4B-A1E10①				
		1NC	—	—	NC	YW4B-A1E01①				
		2NO	NO	—	NO	YW4B-A1E20①				
		2NC	NC	—	NC	YW4B-A1E02①				
		1NO-1NC	NO	—	NC	YW4B-A1E11①				
 	Momentary	1NO	NO	—	—	YW4B-M2E10①	B: black G: green R: red S: blue W: white Y: yellow			
		1NC	—	—	NC	YW4B-M2E01①				
		2NO	NO	—	NO	YW4B-M2E20①				
		2NC	NC	—	NC	YW4B-M2E02①				
	Maintained	1NO-1NC	NO	—	NC	YW4B-M2E11①				
		1NO	NO	—	—	YW4B-A2E10①				
		1NC	—	—	NC	YW4B-A2E01①				
		2NO	NO	—	NO	YW4B-A2E20①				
		2NC	NC	—	NC	YW4B-A2E02①				
		1NO-1NC	NO	—	NC	YW4B-A2E11①				
		 	Momentary	1NO	NO	—		—	YW4B-M4E10①	B: black G: green R: red S: blue W: white Y: yellow
				1NC	—	—		NC	YW4B-M4E01①	
				2NO	NO	—		NO	YW4B-M4E20①	
				2NC	NC	—		NC	YW4B-M4E02①	
Maintained	1NO-1NC		NO	—	NC	YW4B-M4E11①				
	1NO		NO	—	—	YW4B-A4E10①				
	1NC		—	—	NC	YW4B-A4E01①				
	2NO		NO	—	NO	YW4B-A4E20①				
	2NC		NC	—	NC	YW4B-A4E02①				
	1NO-1NC		NO	—	NC	YW4B-A4E11①				





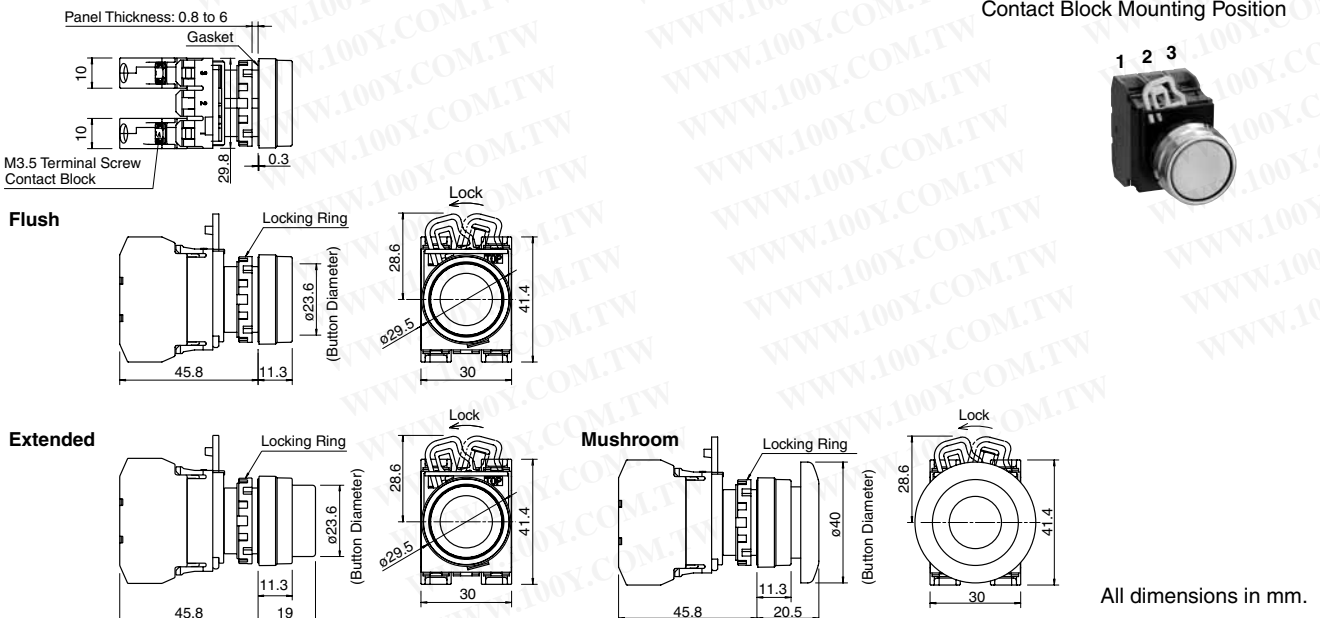



Note: Specify a button color code in place of ① in the Part No.

### Dimensions



## Pilot Lights (Unibody)

Package Quantity: 1

Shape	Lamp	Operating Voltage	Part No.	② Lens Color Code
Flush Full Voltage  	LED	6V AC/DC	<b>YW1P-1UQ2</b> ②	A: amber G: green PW: pure white R: red S: blue W: white Y: yellow
		12V AC/DC	<b>YW1P-1UQ3</b> ②	
		24V AC/DC	<b>YW1P-1UQ4</b> ②	
		100/110V AC	<b>YW1P-1UQH</b> ②	
		230/240V AC	<b>YW1P-1UQM3</b> ②	
Flush Marking Full Voltage  	LED	6V AC/DC	<b>YW1P-1BUQ2</b> ②	
		12V AC/DC	<b>YW1P-1BUQ3</b> ②	
		24V AC/DC	<b>YW1P-1BUQ4</b> ②	
		100/110V AC	<b>YW1P-1BUQH</b> ②	
		230/240V AC	<b>YW1P-1BUQM3</b> ②	
Extended Full Voltage  	LED	6V AC/DC	<b>YW1P-2TUQ2</b> ②	
		12V AC/DC	<b>YW1P-2TUQ3</b> ②	
		24V AC/DC	<b>YW1P-2TUQ4</b> ②	
		100/110V AC	<b>YW1P-2TUQH</b> ②	
		230/240V AC	<b>YW1P-2TUQM3</b> ②	
Dome Full Voltage  	LED	6V AC/DC	<b>YW1P-2UQ2</b> ②	
		12V AC/DC	<b>YW1P-2UQ3</b> ②	
		24V AC/DC	<b>YW1P-2UQ4</b> ②	
		100/110V AC	<b>YW1P-2UQH</b> ②	
		230/240V AC	<b>YW1P-2UQM3</b> ②	

## Dimensions

### Flush

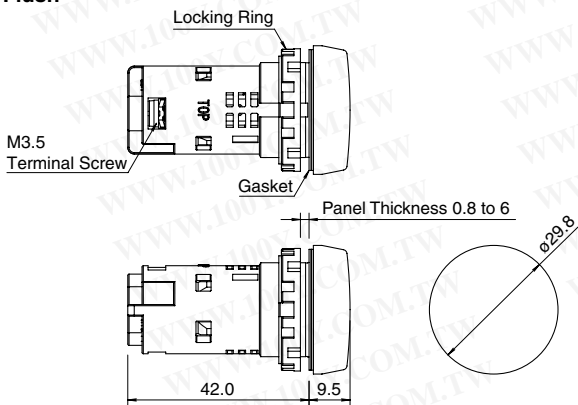

### Flush Marking

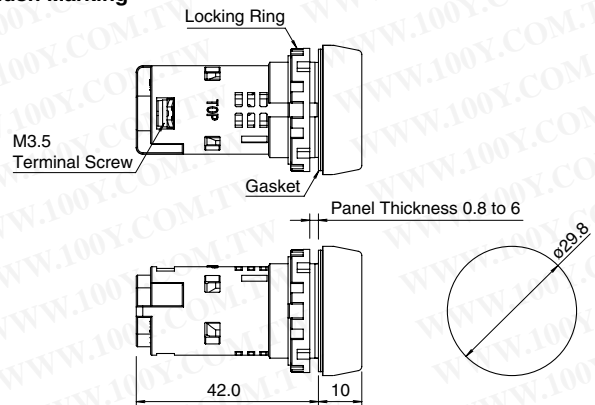

### Extended

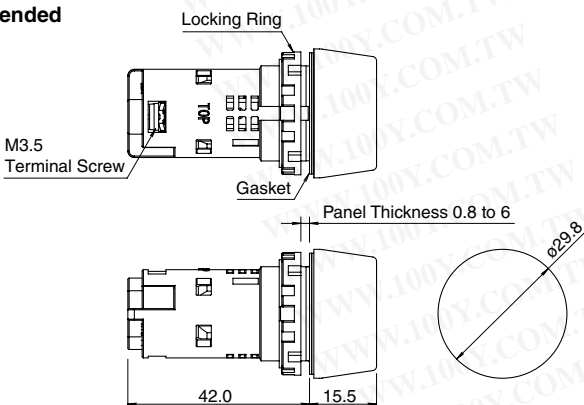

### Dome

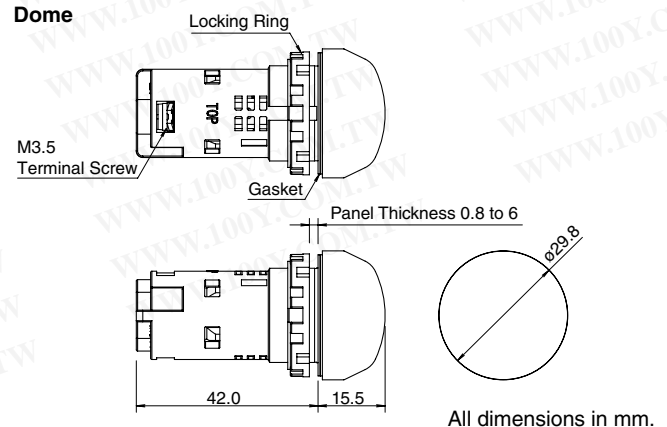

All dimensions in mm.

# ø22 YW Series Pilot Lights

## Pilot Lights (with Removable Lamp Terminal)

Package Quantity: 1

Shape	Lamp	Operating Voltage	Part No.	② Lens Color Code	
Flush Full Voltage  	Without Lamp	250V AC/DC max.	<b>YW1P-1EQ0</b> ②	A (amber), C (clear), G (green), R (red), S (blue), W (white), Y (yellow)	
		LED	6V AC/DC	<b>YW1P-1EQ2</b> ②	A (amber), G (green), PW (pure white), R (red), S (blue), W (white), Y (yellow) Built-in LED lamp: LSED-③②
			12V AC/DC	<b>YW1P-1EQ3</b> ②	
			24V AC/DC	<b>YW1P-1EQ4</b> ②	
			110V AC/DC	<b>YW1P-1EQH</b> ②	
	230/240V AC/DC	<b>YW1P-1EQM3</b> ②			
	Incandescent	6V AC/DC	<b>YW1P-1EQ5</b> ②	A (amber), C (clear), G (green), R (red), S (blue), W (white), Y (yellow) Built-in incandescent lamp: LS-T③	
		12V AC/DC	<b>YW1P-1EQ6</b> ②		
		24V AC/DC	<b>YW1P-1EQ7</b> ②		
	Flush Transformer  	LED	100/110V AC	<b>YW1P-1EH2</b> ②	A (amber), G (green), PW (pure white), R (red), S (blue), W (white), Y (yellow) Built-in LED lamp: LSED-6②
200/220V AC			<b>YW1P-1EM2</b> ②		
115/120V AC			<b>YW1P-1EH22</b> ②		
230/240V AC			<b>YW1P-1EM42</b> ②		
Incandescent		100/110V AC	<b>YW1P-1EH5</b> ②	A (amber), C (clear), G (green), R (red), S (blue), W (white), Y (yellow) Built-in incandescent lamp: LS-T6	
		200/220V AC	<b>YW1P-1EM5</b> ②		
		115/120V AC	<b>YW1P-1EH25</b> ②		
		230/240V AC	<b>YW1P-1EM45</b> ②		
Flush Marking Full Voltage  		Without Lamp	250V AC/DC max.	<b>YW1P-1BEQ0</b> ②	A (amber), G (green), R (red), S (blue), W (white), Y (yellow)
			LED	6V AC/DC	<b>YW1P-1BEQ2</b> ②
	12V AC/DC			<b>YW1P-1BEQ3</b> ②	
	24V AC/DC			<b>YW1P-1BEQ4</b> ②	
	110V AC/DC			<b>YW1P-1BEQH</b> ②	
	230/240V AC/DC	<b>YW1P-1BEQM3</b> ②			
	Incandescent	6V AC/DC	<b>YW1P-1BEQ5</b> ②	A (amber), G (green), R (red), S (blue), W (white), Y (yellow) Built-in incandescent lamp: LS-T③	
		12V AC/DC	<b>YW1P-1BEQ6</b> ②		
		24V AC/DC	<b>YW1P-1BEQ7</b> ②		
	Flush Marking Transformer  	LED	100/110V AC	<b>YW1P-1BEH2</b> ②	A (amber), G (green), PW (pure white), R (red), S (blue), W (white), Y (yellow) Built-in LED lamp: LSED-6②
200/220V AC			<b>YW1P-1BEM2</b> ②		
115/120V AC			<b>YW1P-1BEH22</b> ②		
230/240V AC			<b>YW1P-1BEM42</b> ②		
Incandescent		100/110V AC	<b>YW1P-1BEH5</b> ②	A (amber), G (green), R (red), S (blue), W (white), Y (yellow) Built-in incandescent lamp: LS-T6	
		200/220V AC	<b>YW1P-1BEM5</b> ②		
		115/120V AC	<b>YW1P-1BEH25</b> ②		
		230/240V AC	<b>YW1P-1BEM45</b> ②		

Note: Specify a lens color code in place of ② in the Part No.  
Clear lenses are used for PW (pure white) illumination of pilot lights.

# YW Series Pilot Lights ø22

Shape	Lamp	Operating Voltage	Part No.	② Lens Color Code
Extended Full Voltage  	Without Lamp	250V AC/DC max.	<b>YW1P-2TEQ0</b> ②	A (amber), C (clear), G (green), R (red), S (blue), W (white), Y (yellow)
		6V AC/DC	<b>YW1P-2TEQ2</b> ②	A (amber), G (green), PW (pure white), R (red), S (blue), W (white), Y (yellow) Built-in LED lamp: LSED-3②
	12V AC/DC	<b>YW1P-2TEQ3</b> ②		
	24V AC/DC	<b>YW1P-2TEQ4</b> ②		
	110V AC/DC	<b>YW1P-2TEQH</b> ②		
	230/240V AC/DC	<b>YW1P-2TEQM3</b> ②		
	Incandescent	6V AC/DC	<b>YW1P-2TEQ5</b> ②	A (amber), C (clear), G (green), R (red), S (blue), W (white), Y (yellow) Built-in incandescent lamp: LS-T③
		12V AC/DC	<b>YW1P-2TEQ6</b> ②	
		24V AC/DC	<b>YW1P-2TEQ7</b> ②	
	Extended Transformer  	LED	100/110V AC	<b>YW1P-2TEH2</b> ②
200/220V AC			<b>YW1P-2TEM2</b> ②	
115/120V AC			<b>YW1P-2TEH22</b> ②	
230/240V AC			<b>YW1P-2TEM42</b> ②	
Incandescent		100/110V AC	<b>YW1P-2TEH5</b> ②	A (amber), C (clear), G (green), R (red), S (blue), W (white), Y (yellow) Built-in incandescent lamp: LS-T6
		200/220V AC	<b>YW1P-2TEM5</b> ②	
		115/120V AC	<b>YW1P-2TEH25</b> ②	
		230/240V AC	<b>YW1P-2TEM45</b> ②	
Dome Full Voltage  	Without Lamp	250V AC/DC max.	<b>YW1P-2EQ0</b> ②	A (amber), C (clear), G (green), R (red), S (blue), W (white), Y (yellow)
		6V AC/DC	<b>YW1P-2EQ2</b> ②	A (amber), G (green), PW (pure white), R (red), S (blue), W (white), Y (yellow) Built-in LED lamp: LSED-3②
	12V AC/DC	<b>YW1P-2EQ3</b> ②		
	24V AC/DC	<b>YW1P-2EQ4</b> ②		
	110V AC/DC	<b>YW1P-2EQH</b> ②		
	230/240V AC/DC	<b>YW1P-2EQM3</b> ②		
	Incandescent	6V AC/DC	<b>YW1P-2EQ5</b> ②	A (amber), C (clear), G (green), R (red), S (blue), W (white), Y (yellow) Built-in incandescent lamp: LS-T③
		12V AC/DC	<b>YW1P-2EQ6</b> ②	
		24V AC/DC	<b>YW1P-2EQ7</b> ②	
	Dome Transformer  	LED	100/110V AC	<b>YW1P-2EH2</b> ②
200/220V AC			<b>YW1P-2EM2</b> ②	
115/120V AC			<b>YW1P-2EH22</b> ②	
230/240V AC			<b>YW1P-2EM42</b> ②	
Incandescent		100/110V AC	<b>YW1P-2EH5</b> ②	A (amber), C (clear), G (green), R (red), S (blue), W (white), Y (yellow) Built-in incandescent lamp: LS-T6
		200/220V AC	<b>YW1P-2EM5</b> ②	
		115/120V AC	<b>YW1P-2EH25</b> ②	
		230/240V AC	<b>YW1P-2EM45</b> ②	

Note: Specify a lens color code in place of ② in the Part No.  
Clear lenses are used for PW (pure white) illumination of pilot lights.

# ø22 YW Series Pilot Lights

## Dimensions (Pilot Lights with Removable Lamp Terminal)

### Flush

#### Full Voltage

Panel Thickness 0.8 to 6

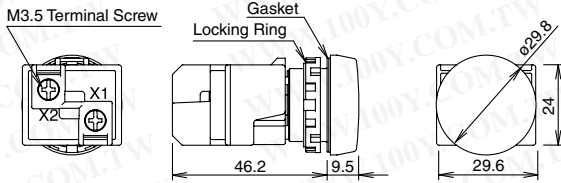

#### Transformer

Panel Thickness 0.8 to 6

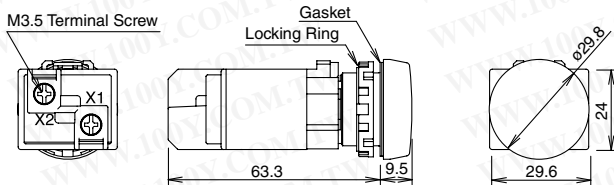

### Flush Marking

#### Full Voltage

Panel Thickness 0.8 to 6

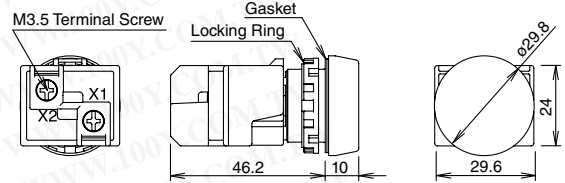

#### Transformer

Panel Thickness 0.8 to 6

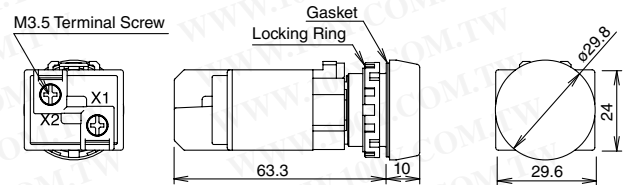

### Extended

#### Full Voltage

Panel Thickness 0.8 to 6

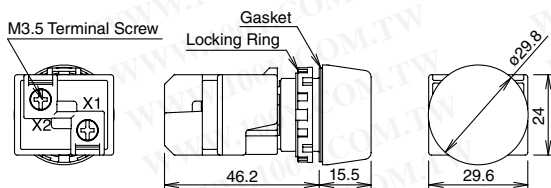

#### Transformer

Panel Thickness 0.8 to 6

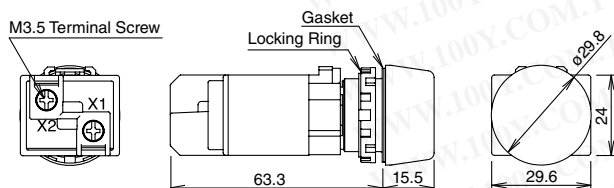

### Dome

#### Full Voltage

Panel Thickness 0.8 to 6

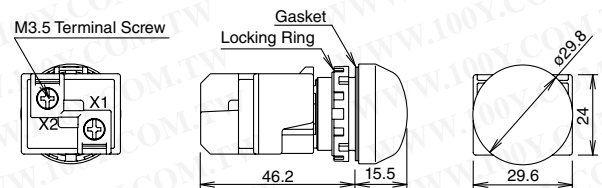

#### Transformer



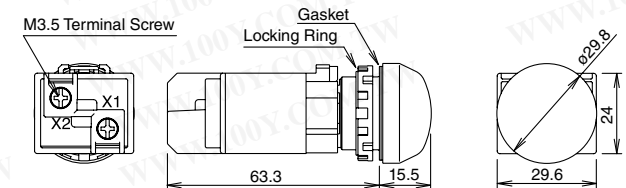

Panel Thickness 0.8 to 6



# YW Series Illuminated Pushbuttons ø22

## Illuminated Pushbuttons with Plastic Bezel



Package Quantity: 1

Shape	Lamp	Operation	Contact	Contact Block Mounting Position			Part No.	③ Operating Voltage Code	② Lens Color Code				
				1	2	3							
  	Without Lamp	Momentary	1NO	NO	FA	—	YW1L-M2E10Q0②	0: without lamp 250V AC/DC max.	A: amber G: green R: red S: blue W: white Y: yellow				
			1NC	—	FA	NC	YW1L-M2E01Q0②						
			2NO	NO	FA	NO	YW1L-M2E20Q0②						
			2NC	NC	FA	NC	YW1L-M2E02Q0②						
		1NO-1NC	NO	FA	NC	YW1L-M2E11Q0②							
		Maintained	1NO	NO	FA	—	YW1L-A2E10Q0②						
			1NC	—	FA	NC	YW1L-A2E01Q0②						
			2NO	NO	FA	NO	YW1L-A2E20Q0②						
			2NC	NC	FA	NC	YW1L-A2E02Q0②						
		1NO-1NC	NO	FA	NC	YW1L-A2E11Q0②							
		LED	Momentary	1NO	NO	FA	—			YW1L-M2E10Q③②	2: 6V AC/DC 3: 12V AC/DC 4: 24V AC/DC H: 110V AC/DC M3: 230/240V AC/DC	A: amber G: green PW: pure white R: red S: blue W: white Y: yellow Built-in LED lamp: LSED-③②	
				1NC	—	FA	NC			YW1L-M2E01Q③②			
	2NO			NO	FA	NO	YW1L-M2E20Q③②						
	2NC			NC	FA	NC	YW1L-M2E02Q③②						
	1NO-1NC		NO	FA	NC	YW1L-M2E11Q③②							
	Maintained		1NO	NO	FA	—	YW1L-A2E10Q③②						
			1NC	—	FA	NC	YW1L-A2E01Q③②						
			2NO	NO	FA	NO	YW1L-A2E20Q③②						
			2NC	NC	FA	NC	YW1L-A2E02Q③②						
	1NO-1NC		NO	FA	NC	YW1L-A2E11Q③②							
	  		Without Lamp	Momentary	1NO	NO	FA	—	YW1L-MF2E10Q0②	0: without lamp 250V AC/DC max.			A: amber G: green R: red S: blue W: white Y: yellow
					1NC	—	FA	NC	YW1L-MF2E01Q0②				
		2NO			NO	FA	NO	YW1L-MF2E20Q0②					
		2NC			NC	FA	NC	YW1L-MF2E02Q0②					
1NO-1NC		NO		FA	NC	YW1L-MF2E11Q0②							
Maintained		1NO		NO	FA	—	YW1L-AF2E10Q0②						
		1NC		—	FA	NC	YW1L-AF2E01Q0②						
		2NO		NO	FA	NO	YW1L-AF2E20Q0②						
		2NC		NC	FA	NC	YW1L-AF2E02Q0②						
1NO-1NC		NO		FA	NC	YW1L-AF2E11Q0②							
LED		Momentary		1NO	NO	FA	—	YW1L-MF2E10Q③②	2: 6V AC/DC 3: 12V AC/DC 4: 24V AC/DC H: 110V AC/DC M3: 230/240V AC/DC		A: amber G: green PW: pure white R: red S: blue W: white Y: yellow Built-in LED lamp: LSED-③②		
				1NC	—	FA	NC	YW1L-MF2E01Q③②					
			2NO	NO	FA	NO	YW1L-MF2E20Q③②						
			2NC	NC	FA	NC	YW1L-MF2E02Q③②						
		1NO-1NC	NO	FA	NC	YW1L-MF2E11Q③②							
		Maintained	1NO	NO	FA	—	YW1L-AF2E10Q③②						
			1NC	—	FA	NC	YW1L-AF2E01Q③②						
			2NO	NO	FA	NO	YW1L-AF2E20Q③②						
			2NC	NC	FA	NC	YW1L-AF2E02Q③②						
		1NO-1NC	NO	FA	NC	YW1L-AF2E11Q③②							
		Incandescent	Momentary	1NO	NO	FA	—	YW1L-MF2E10Q③②		5: 6V AC/DC 6: 12V AC/DC 7: 24V AC/DC		A: amber G: green R: red S: blue W: white Y: yellow Built-in incandescent lamp: LS-T③	
				1NC	—	FA	NC	YW1L-MF2E01Q③②					
2NO				NO	FA	NO	YW1L-MF2E20Q③②						
2NC				NC	FA	NC	YW1L-MF2E02Q③②						
1NO-1NC	NO		FA	NC	YW1L-MF2E11Q③②								
Maintained	1NO		NO	FA	—	YW1L-AF2E10Q③②							
	1NC		—	FA	NC	YW1L-AF2E01Q③②							
	2NO		NO	FA	NO	YW1L-AF2E20Q③②							
	2NC		NC	FA	NC	YW1L-AF2E02Q③②							
1NO-1NC	NO		FA	NC	YW1L-AF2E11Q③②								

Note: Specify a lens color code in place of ② in the Part No.  
Specify an operating voltage code in place of ③ in the Part No.

FA: Full voltage adapter

# ø22 YW Series Illuminated Pushbuttons

Shape	Lamp	Operation	Contact	Contact Block Mounting Position			Part No.	③ Operating Voltage Code	② Lens Color Code			
				1	2	3						
 	Without Lamp	Momentary	1NO	NO	FA	—	YW1L-M4E10Q0②	0: without lamp 250V AC/DC max.	A: amber G: green R: red S: blue W: white Y: yellow			
			1NC	—	FA	NC	YW1L-M4E01Q0②					
			2NO	NO	FA	NO	YW1L-M4E20Q0②					
			2NC	NC	FA	NC	YW1L-M4E02Q0②					
		Maintained	1NO-1NC	NO	FA	NC	YW1L-M4E11Q0②					
			1NO	NO	FA	—	YW1L-A4E10Q0②					
			1NC	—	FA	NC	YW1L-A4E01Q0②					
			2NO	NO	FA	NO	YW1L-A4E20Q0②					
		LED	Momentary	2NC	NC	FA	NC			YW1L-A4E02Q0②	2: 6V AC/DC 3: 12V AC/DC 4: 24V AC/DC H: 110V AC/DC M3: 230/240V AC/DC	A: amber G: green PW: pure white R: red S: blue W: white Y: yellow Built-in LED lamp: LSED-③②
				1NO-1NC	NO	FA	NC			YW1L-M4E11Q③②		
				1NO	NO	FA	—			YW1L-M4E10Q③②		
				1NC	—	FA	NC			YW1L-M4E01Q③②		
	Maintained		2NO	NO	FA	NO	YW1L-M4E20Q③②					
			2NC	NC	FA	NC	YW1L-M4E02Q③②					
			1NO-1NC	NO	FA	NC	YW1L-M4E11Q③②					
			1NO	NO	FA	—	YW1L-A4E10Q③②					
	Incandescent		Momentary	1NC	—	FA	NC	YW1L-A4E01Q③②	5: 6V AC/DC 6: 12V AC/DC 7: 24V AC/DC	A: amber G: green R: red S: blue W: white Y: yellow Built-in incandescent lamp: LS-T③		
				2NO	NO	FA	NO	YW1L-A4E20Q③②				
				2NC	NC	FA	NC	YW1L-A4E02Q③②				
				1NO-1NC	NO	FA	NC	YW1L-A4E11Q③②				
		Maintained	1NO	NO	FA	—	YW1L-M4E10Q③②					
			1NC	—	FA	NC	YW1L-M4E01Q③②					
			2NO	NO	FA	NO	YW1L-M4E20Q③②					
			2NC	NC	FA	NC	YW1L-M4E02Q③②					
				1NO-1NC	NO	FA	NC	YW1L-A4E11Q③②				

Note: Specify a lens color code in place of ② in the Part No.  
Specify an operating voltage code in place of ③ in the Part No.

FA: Full voltage adapter

## Dimensions (Illuminated Pushbuttons with Plastic Bezel)

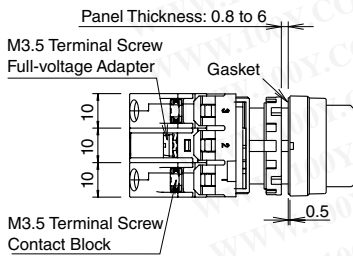

Contact Block Mounting Position



### Extended

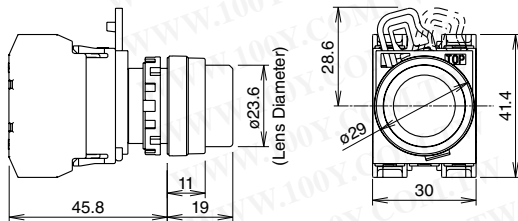

### Mushroom

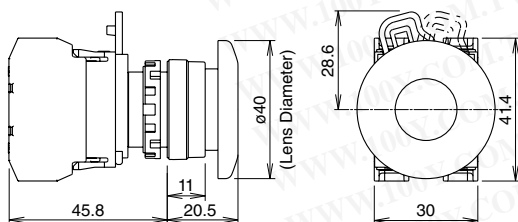

### Extended with Full Shroud

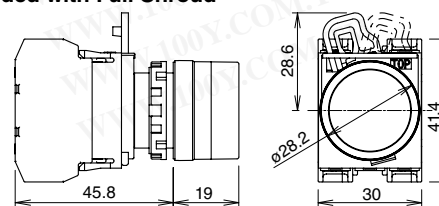





All dimensions in mm.

# YW Series Illuminated Pushbuttons ø22

## Illuminated Pushbuttons with Metal Bezel



Package Quantity: 1

Shape	Lamp	Operation	Contact	Contact Block Mounting Position			Part No.	③ Operating Voltage Code	② Lens Color Code																																																																																																																																																																																																																																																
				1	2	3																																																																																																																																																																																																																																																			
	Without Lamp	Momentary	1NO	NO	FA	—	YW4L-M2E10Q0②	0: without lamp 250V AC/DC max.	A: amber G: green R: red S: blue W: white Y: yellow																																																																																																																																																																																																																																																
			1NC	—	FA	NC	YW4L-M2E01Q0②																																																																																																																																																																																																																																																		
			2NO	NO	FA	NO	YW4L-M2E20Q0②																																																																																																																																																																																																																																																		
			2NC	NC	FA	NC	YW4L-M2E02Q0②																																																																																																																																																																																																																																																		
		1NO-1NC	NO	FA	NC	YW4L-M2E11Q0②																																																																																																																																																																																																																																																			
		1NO	NO	FA	—	YW4L-A2E10Q0②																																																																																																																																																																																																																																																			
		1NC	—	FA	NC	YW4L-A2E01Q0②																																																																																																																																																																																																																																																			
		2NO	NO	FA	NO	YW4L-A2E20Q0②																																																																																																																																																																																																																																																			
		2NC	NC	FA	NC	YW4L-A2E02Q0②																																																																																																																																																																																																																																																			
		1NO-1NC	NO	FA	NC	YW4L-A2E11Q0②																																																																																																																																																																																																																																																			
		1NO	NO	FA	—	YW4L-M2E10Q③②	2: 6V AC/DC 3: 12V AC/DC 4: 24V AC/DC H: 110V AC/DC M3: 230/240V AC/DC			A: amber G: green PW: pure white R: red S: blue W: white Y: yellow  Built-in LED lamp: LSED-③②																																																																																																																																																																																																																																															
		1NC	—	FA	NC	YW4L-M2E01Q③②																																																																																																																																																																																																																																																			
	2NO	NO	FA	NO	YW4L-M2E20Q③②																																																																																																																																																																																																																																																				
	2NC	NC	FA	NC	YW4L-M2E02Q③②																																																																																																																																																																																																																																																				
	1NO-1NC	NO	FA	NC	YW4L-M2E11Q③②																																																																																																																																																																																																																																																				
	Maintained	1NO	NO	FA	—	YW4L-A2E10Q③②		1NC	—		FA	NC	YW4L-A2E01Q③②	2NO	NO	FA	NO	YW4L-A2E20Q③②	2NC	NC	FA	NC	YW4L-A2E02Q③②	1NO-1NC	NO	FA	NC	YW4L-A2E11Q③②	Incandescent	Momentary	1NO	NO	FA	—	YW4L-M2E10Q③②	5: 6V AC/DC 6: 12V AC/DC 7: 24V AC/DC	A: amber G: green R: red S: blue W: white Y: yellow  Built-in incandescent lamp: LS-T③	1NC	—	FA	NC	YW4L-M2E01Q③②	2NO	NO	FA	NO	YW4L-M2E20Q③②	2NC	NC	FA	NC	YW4L-M2E02Q③②	1NO-1NC	NO	FA	NC	YW4L-M2E11Q③②	Maintained	1NO	NO	FA	—	YW4L-A2E10Q③②	1NC	—	FA	NC	YW4L-A2E01Q③②	2NO	NO	FA	NO	YW4L-A2E20Q③②	2NC	NC	FA	NC	YW4L-A2E02Q③②	1NO-1NC	NO	FA	NC	YW4L-A2E11Q③②		Without Lamp	Momentary	1NO	NO	FA	—	YW4L-MF2E10Q0②	0: without lamp 250V AC/DC max.	A: amber G: green R: red S: blue W: white Y: yellow	1NC	—	FA	NC	YW4L-MF2E01Q0②	2NO	NO	FA	NO	YW4L-MF2E20Q0②	2NC	NC	FA	NC	YW4L-MF2E02Q0②	1NO-1NC	NO	FA	NC	YW4L-MF2E11Q0②	Maintained	1NO	NO	FA	—	YW4L-AF2E10Q0②	1NC	—	FA	NC	YW4L-AF2E01Q0②	2NO	NO	FA	NO	YW4L-AF2E20Q0②	2NC	NC	FA	NC	YW4L-AF2E02Q0②	1NO-1NC	NO	FA	NC	YW4L-AF2E11Q0②	LED	Momentary	1NO	NO	FA	—	YW4L-MF2E10Q③②	2: 6V AC/DC 3: 12V AC/DC 4: 24V AC/DC H: 110V AC/DC M3: 230/240V AC/DC	A: amber G: green PW: pure white R: red S: blue W: white Y: yellow  Built-in LED lamp: LSED-③②	1NC	—	FA	NC	YW4L-MF2E01Q③②	2NO	NO	FA	NO	YW4L-MF2E20Q③②	2NC	NC	FA	NC	YW4L-MF2E02Q③②	1NO-1NC	NO	FA	NC	YW4L-MF2E11Q③②	Maintained	1NO	NO	FA	—	YW4L-AF2E10Q③②	1NC	—	FA	NC	YW4L-AF2E01Q③②	2NO	NO	FA	NO	YW4L-AF2E20Q③②	2NC	NC	FA	NC	YW4L-AF2E02Q③②	1NO-1NC	NO	FA	NC	YW4L-AF2E11Q③②	Incandescent	Momentary	1NO	NO	FA	—	YW4L-MF2E10Q③②	5: 6V AC/DC 6: 12V AC/DC 7: 24V AC/DC	A: amber G: green R: red S: blue W: white Y: yellow  Built-in incandescent lamp: LS-T③	1NC	—	FA	NC	YW4L-MF2E01Q③②	2NO	NO	FA	NO	YW4L-MF2E20Q③②	2NC	NC	FA	NC	YW4L-MF2E02Q③②	1NO-1NC	NO	FA	NC	YW4L-MF2E11Q③②	Maintained	1NO	NO	FA	—	YW4L-AF2E10Q③②	1NC	—	FA	NC	YW4L-AF2E01Q③②	2NO	NO	FA	NO	YW4L-AF2E20Q③②	2NC	NC	FA	NC	YW4L-AF2E02Q③②	1NO-1NC	NO	FA	NC	YW4L-AF2E11Q③②
		1NO	NO	FA	—	YW4L-A2E10Q③②																																																																																																																																																																																																																																																			
		1NC	—	FA	NC	YW4L-A2E01Q③②																																																																																																																																																																																																																																																			
		2NO	NO	FA	NO	YW4L-A2E20Q③②																																																																																																																																																																																																																																																			
		2NC	NC	FA	NC	YW4L-A2E02Q③②																																																																																																																																																																																																																																																			
		1NO-1NC	NO	FA	NC	YW4L-A2E11Q③②																																																																																																																																																																																																																																																			
	1NO	NO	FA	—	YW4L-M2E10Q③②	5: 6V AC/DC 6: 12V AC/DC 7: 24V AC/DC		A: amber G: green R: red S: blue W: white Y: yellow  Built-in incandescent lamp: LS-T③																																																																																																																																																																																																																																																	
	1NC	—	FA	NC	YW4L-M2E01Q③②																																																																																																																																																																																																																																																				
	2NO	NO	FA	NO	YW4L-M2E20Q③②																																																																																																																																																																																																																																																				
2NC	NC	FA	NC	YW4L-M2E02Q③②																																																																																																																																																																																																																																																					
1NO-1NC	NO	FA	NC	YW4L-M2E11Q③②																																																																																																																																																																																																																																																					
Maintained	1NO	NO	FA	—	YW4L-A2E10Q③②		1NC		—	FA	NC	YW4L-A2E01Q③②	2NO	NO	FA	NO	YW4L-A2E20Q③②	2NC	NC	FA	NC	YW4L-A2E02Q③②	1NO-1NC	NO	FA	NC	YW4L-A2E11Q③②		Without Lamp	Momentary	1NO	NO	FA	—	YW4L-MF2E10Q0②			0: without lamp 250V AC/DC max.	A: amber G: green R: red S: blue W: white Y: yellow	1NC	—	FA	NC	YW4L-MF2E01Q0②	2NO	NO	FA	NO	YW4L-MF2E20Q0②	2NC	NC	FA	NC	YW4L-MF2E02Q0②	1NO-1NC	NO	FA	NC	YW4L-MF2E11Q0②	Maintained	1NO	NO	FA	—	YW4L-AF2E10Q0②	1NC	—	FA	NC	YW4L-AF2E01Q0②	2NO	NO	FA	NO	YW4L-AF2E20Q0②	2NC	NC	FA	NC	YW4L-AF2E02Q0②	1NO-1NC	NO	FA			NC	YW4L-AF2E11Q0②	LED	Momentary	1NO	NO			FA	—	YW4L-MF2E10Q③②	2: 6V AC/DC 3: 12V AC/DC 4: 24V AC/DC H: 110V AC/DC M3: 230/240V AC/DC	A: amber G: green PW: pure white R: red S: blue W: white Y: yellow  Built-in LED lamp: LSED-③②	1NC	—	FA	NC	YW4L-MF2E01Q③②	2NO	NO	FA	NO	YW4L-MF2E20Q③②	2NC	NC	FA	NC	YW4L-MF2E02Q③②	1NO-1NC	NO	FA	NC	YW4L-MF2E11Q③②	Maintained	1NO	NO	FA	—	YW4L-AF2E10Q③②	1NC	—	FA	NC	YW4L-AF2E01Q③②	2NO	NO	FA	NO	YW4L-AF2E20Q③②	2NC	NC	FA	NC	YW4L-AF2E02Q③②	1NO-1NC	NO	FA	NC	YW4L-AF2E11Q③②	Incandescent	Momentary			1NO	NO	FA	—	YW4L-MF2E10Q③②	5: 6V AC/DC 6: 12V AC/DC 7: 24V AC/DC	A: amber G: green R: red S: blue W: white Y: yellow  Built-in incandescent lamp: LS-T③	1NC	—	FA	NC	YW4L-MF2E01Q③②	2NO	NO	FA	NO	YW4L-MF2E20Q③②	2NC	NC	FA	NC	YW4L-MF2E02Q③②	1NO-1NC	NO	FA	NC	YW4L-MF2E11Q③②	Maintained	1NO	NO	FA	—	YW4L-AF2E10Q③②	1NC	—	FA	NC	YW4L-AF2E01Q③②	2NO	NO	FA	NO	YW4L-AF2E20Q③②	2NC	NC	FA	NC	YW4L-AF2E02Q③②	1NO-1NC	NO	FA	NC	YW4L-AF2E11Q③②																																																
	1NO	NO	FA	—	YW4L-A2E10Q③②																																																																																																																																																																																																																																																				
	1NC	—	FA	NC	YW4L-A2E01Q③②																																																																																																																																																																																																																																																				
	2NO	NO	FA	NO	YW4L-A2E20Q③②																																																																																																																																																																																																																																																				
	2NC	NC	FA	NC	YW4L-A2E02Q③②																																																																																																																																																																																																																																																				
	1NO-1NC	NO	FA	NC	YW4L-A2E11Q③②																																																																																																																																																																																																																																																				
	Without Lamp	Momentary	1NO	NO	FA		—		YW4L-MF2E10Q0②	0: without lamp 250V AC/DC max.	A: amber G: green R: red S: blue W: white Y: yellow																																																																																																																																																																																																																																														
			1NC	—	FA	NC	YW4L-MF2E01Q0②																																																																																																																																																																																																																																																		
			2NO	NO	FA	NO	YW4L-MF2E20Q0②																																																																																																																																																																																																																																																		
			2NC	NC	FA	NC	YW4L-MF2E02Q0②																																																																																																																																																																																																																																																		
		1NO-1NC	NO	FA	NC	YW4L-MF2E11Q0②																																																																																																																																																																																																																																																			
		1NO	NO	FA	—	YW4L-AF2E10Q0②																																																																																																																																																																																																																																																			
		1NC	—	FA	NC	YW4L-AF2E01Q0②																																																																																																																																																																																																																																																			
		2NO	NO	FA	NO	YW4L-AF2E20Q0②																																																																																																																																																																																																																																																			
		2NC	NC	FA	NC	YW4L-AF2E02Q0②																																																																																																																																																																																																																																																			
		1NO-1NC	NO	FA	NC	YW4L-AF2E11Q0②																																																																																																																																																																																																																																																			
		1NO	NO	FA	—	YW4L-MF2E10Q③②	2: 6V AC/DC 3: 12V AC/DC 4: 24V AC/DC H: 110V AC/DC M3: 230/240V AC/DC	A: amber G: green PW: pure white R: red S: blue W: white Y: yellow  Built-in LED lamp: LSED-③②																																																																																																																																																																																																																																																	
		1NC	—	FA	NC	YW4L-MF2E01Q③②																																																																																																																																																																																																																																																			
	2NO	NO	FA	NO	YW4L-MF2E20Q③②																																																																																																																																																																																																																																																				
	2NC	NC	FA	NC	YW4L-MF2E02Q③②																																																																																																																																																																																																																																																				
	1NO-1NC	NO	FA	NC	YW4L-MF2E11Q③②																																																																																																																																																																																																																																																				
	Maintained	1NO	NO	FA	—	YW4L-AF2E10Q③②			1NC	—	FA	NC	YW4L-AF2E01Q③②	2NO	NO	FA	NO	YW4L-AF2E20Q③②	2NC	NC	FA	NC	YW4L-AF2E02Q③②	1NO-1NC	NO	FA	NC		YW4L-AF2E11Q③②	Incandescent	Momentary	1NO	NO	FA	—	YW4L-MF2E10Q③②	5: 6V AC/DC 6: 12V AC/DC 7: 24V AC/DC	A: amber G: green R: red S: blue W: white Y: yellow  Built-in incandescent lamp: LS-T③	1NC	—	FA	NC	YW4L-MF2E01Q③②	2NO	NO	FA	NO	YW4L-MF2E20Q③②	2NC	NC	FA	NC	YW4L-MF2E02Q③②	1NO-1NC	NO	FA	NC	YW4L-MF2E11Q③②	Maintained	1NO	NO	FA	—	YW4L-AF2E10Q③②	1NC	—	FA	NC	YW4L-AF2E01Q③②	2NO	NO	FA	NO	YW4L-AF2E20Q③②	2NC	NC	FA	NC	YW4L-AF2E02Q③②	1NO-1NC	NO	FA	NC	YW4L-AF2E11Q③②																																																																																																																																																																					
		1NO	NO	FA	—	YW4L-AF2E10Q③②																																																																																																																																																																																																																																																			
		1NC	—	FA	NC	YW4L-AF2E01Q③②																																																																																																																																																																																																																																																			
		2NO	NO	FA	NO	YW4L-AF2E20Q③②																																																																																																																																																																																																																																																			
		2NC	NC	FA	NC	YW4L-AF2E02Q③②																																																																																																																																																																																																																																																			
		1NO-1NC	NO	FA	NC	YW4L-AF2E11Q③②																																																																																																																																																																																																																																																			
	1NO	NO	FA	—	YW4L-MF2E10Q③②	5: 6V AC/DC 6: 12V AC/DC 7: 24V AC/DC			A: amber G: green R: red S: blue W: white Y: yellow  Built-in incandescent lamp: LS-T③																																																																																																																																																																																																																																																
	1NC	—	FA	NC	YW4L-MF2E01Q③②																																																																																																																																																																																																																																																				
	2NO	NO	FA	NO	YW4L-MF2E20Q③②																																																																																																																																																																																																																																																				
2NC	NC	FA	NC	YW4L-MF2E02Q③②																																																																																																																																																																																																																																																					
1NO-1NC	NO	FA	NC	YW4L-MF2E11Q③②																																																																																																																																																																																																																																																					
Maintained	1NO	NO	FA	—	YW4L-AF2E10Q③②		1NC	—		FA	NC	YW4L-AF2E01Q③②	2NO	NO	FA	NO	YW4L-AF2E20Q③②	2NC	NC	FA	NC	YW4L-AF2E02Q③②	1NO-1NC	NO	FA	NC	YW4L-AF2E11Q③②																																																																																																																																																																																																																														
	1NO	NO	FA	—	YW4L-AF2E10Q③②																																																																																																																																																																																																																																																				
	1NC	—	FA	NC	YW4L-AF2E01Q③②																																																																																																																																																																																																																																																				
	2NO	NO	FA	NO	YW4L-AF2E20Q③②																																																																																																																																																																																																																																																				
	2NC	NC	FA	NC	YW4L-AF2E02Q③②																																																																																																																																																																																																																																																				
	1NO-1NC	NO	FA	NC	YW4L-AF2E11Q③②																																																																																																																																																																																																																																																				

Note: Specify a lens color code in place of ② in the Part No.  
Specify an operating voltage code in place of ③ in the Part No.

FA: Full voltage adapter

# ø22 YW Series Illuminated Pushbuttons

Style	Lamp	Operation	Contact	Contact Block Mounting Position			Part No.	③ Operating Voltage Code	② Lens Color Code			
				1	2	3						
 	Without Lamp	Momentary	1NO	NO	FA	—	YW4L-M4E10Q0 <sup>②</sup>	0: without lamp 250V AC/DC max.	A: amber G: green R: red S: blue W: white Y: yellow			
			1NC	—	FA	NC	YW4L-M4E01Q0 <sup>②</sup>					
			2NO	NO	FA	NO	YW4L-M4E20Q0 <sup>②</sup>					
			2NC	NC	FA	NC	YW4L-M4E02Q0 <sup>②</sup>					
		Maintained	1NO-1NC	NO	FA	NC	YW4L-M4E11Q0 <sup>②</sup>					
			1NO	NO	FA	—	YW4L-A4E10Q0 <sup>②</sup>					
			1NC	—	FA	NC	YW4L-A4E01Q0 <sup>②</sup>					
			2NO	NO	FA	NO	YW4L-A4E20Q0 <sup>②</sup>					
		LED	Momentary	2NC	NC	FA	NC			YW4L-A4E02Q0 <sup>②</sup>	2: 6V AC/DC 3: 12V AC/DC 4: 24V AC/DC H: 110V AC/DC M3: 230/240V AC/DC	A: amber G: green PW: pure white R: red S: blue W: white Y: yellow Built-in LED lamp: LSED-③②
				1NO-1NC	NO	FA	NC			YW4L-M4E11Q <sup>③②</sup>		
				1NO	NO	FA	—			YW4L-M4E10Q <sup>③②</sup>		
				1NC	—	FA	NC			YW4L-M4E01Q <sup>③②</sup>		
	Maintained		2NO	NO	FA	NO	YW4L-M4E20Q <sup>③②</sup>					
			2NC	NC	FA	NC	YW4L-M4E02Q <sup>③②</sup>					
			1NO-1NC	NO	FA	NC	YW4L-M4E11Q <sup>③②</sup>					
			1NO	NO	FA	—	YW4L-A4E10Q <sup>③②</sup>					
	Incandescent		Momentary	1NC	—	FA	NC	YW4L-A4E01Q <sup>③②</sup>	5: 6V AC/DC 6: 12V AC/DC 7: 24V AC/DC	A: amber G: green R: red S: blue W: white Y: yellow Built-in incandescent lamp: LS-T <sup>③</sup>		
				2NO	NO	FA	NO	YW4L-M4E20Q <sup>③②</sup>				
				2NC	NC	FA	NC	YW4L-M4E02Q <sup>③②</sup>				
				1NO-1NC	NO	FA	NC	YW4L-M4E11Q <sup>③②</sup>				
		Maintained	1NO	NO	FA	—	YW4L-A4E10Q <sup>③②</sup>					
			1NC	—	FA	NC	YW4L-A4E01Q <sup>③②</sup>					
			2NO	NO	FA	NO	YW4L-A4E20Q <sup>③②</sup>					
			2NC	NC	FA	NC	YW4L-A4E02Q <sup>③②</sup>					
				1NO-1NC	NO	FA	NC	YW4L-A4E11Q <sup>③②</sup>				

Note: Specify a lens color code in place of ② in the Part No.  
Specify an operating voltage code in place of ③ in the Part No.

FA: Full voltage adapter

## Dimensions (Illuminated Pushbutton with Metal Bezel)

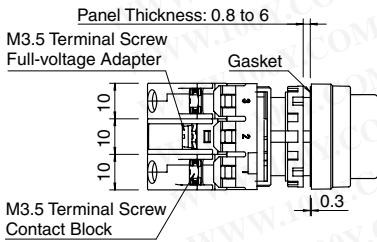

Contact Block Mounting Position



### Extended

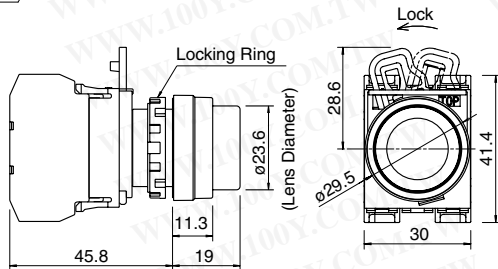

### Mushroom

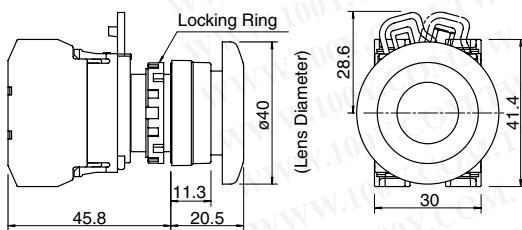

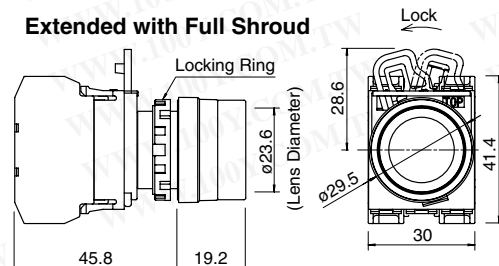

### Extended with Full Shroud



All dimensions in mm.

## Selector Switches with Plastic Bezel

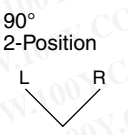

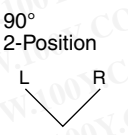
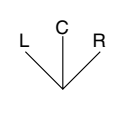
Package Quantity: 1

Shape				Knob						
										
										
No. of Positions	Contact Configuration	Contact Block Mounting Position	Operator Position			Maintained	Spring Return from Right	—	—	
			L	R	—					
90° 2-Position 	1NO (10)	1	NO		●		YW1S-2E10	YW1S-21E10	—	—
		2								
		3								
	1NC (01)	1			●		YW1S-2E01	YW1S-21E01	—	—
		2								
		3	NC	●						
	2NO (20)	1	NO		●		YW1S-2E20	YW1S-21E20	—	—
		2								
		3	NO		●					
	2NC (02)	1	NC	●			YW1S-2E02	YW1S-21E02	—	—
		2								
		3	NC	●						
	1NO-1NC (11)	1	NO		●		YW1S-2E11	YW1S-21E11	—	—
		2								
		3	NC	●						
	3NO (30)	1	NO		●		YW1S-2E30	YW1S-21E30	—	—
		2	NO		●					
		3	NO		●					
3NC (03)	1	NC	●			YW1S-2E03	YW1S-21E03	—	—	
	2	NC	●							
	3	NC	●							
2NO-1NC (21)	1	NO		●		YW1S-2E21	YW1S-21E21	—	—	
	2	NC	●							
	3	NO		●						
1NO-2NC (12)	1	NO		●		YW1S-2E12	YW1S-21E12	—	—	
	2	NC	●							
	3	NC	●							
No. of Positions	Contact Configuration	Contact Block Mounting Position	Operator Position			Maintained	Spring Return from Right	Spring Return from Left	Spring Return Two-Way	
			L	C	R					
45° 3-Position 	2NO (20)	1	NO	●			YW1S-3E20	YW1S-31E20	YW1S-32E20	YW1S-33E20
		2								
		3	NO			●				
	2NO (20N1)	1	NO	●			YW1S-3E20N1	YW1S-31E20N1	YW1S-32E20N1	YW1S-33E20N1
		2	NO			●				
		3	NO			●				
	2NC (02)	1	NC		■		YW1S-3E02	YW1S-31E02	YW1S-32E02	YW1S-33E02
		2								
		3	NC		■					
	2NC (02N1)	1	NC		■		YW1S-3E02N1	YW1S-31E02N1	YW1S-32E02N1	YW1S-33E02N1
		2	NC		■					
		3	NC		■					
	1NO-1NC (11)	1	NO	●			YW1S-3E11	YW1S-31E11	YW1S-32E11	YW1S-33E11
		2								
		3	NC		■					
	1NO-1NC (11N1)	1	NC		■		YW1S-3E11N1	YW1S-31E11N1	YW1S-32E11N1	YW1S-33E11N1
		2								
		3	NO			●				
	1NO-1NC (11N2)	1	NO	●			YW1S-3E11N2	YW1S-31E11N2	YW1S-32E11N2	YW1S-33E11N2
		2	NC		■					
		3								
	1NO-1NC (11N3)	1					YW1S-3E11N3	YW1S-31E11N3	YW1S-32E11N3	YW1S-33E11N3
		2	NC		■					
		3	NO			●				
1NO-1NC (11N4)	1					YW1S-3E11N4	YW1S-31E11N4	YW1S-32E11N4	YW1S-33E11N4	
	2	NO	●							
	3	NC		■						
3NO (30)	1	NO		●		YW1S-3E30	YW1S-31E30	YW1S-32E30	YW1S-33E30	
	2	NO		●						
	3	NO		●						
3NC (03)	1	NC		■		YW1S-3E03	YW1S-31E03	YW1S-32E03	YW1S-33E03	
	2	NC		■						
	3	NC		■						
2NO-1NC (21)	1	NO	●			YW1S-3E21	YW1S-31E21	YW1S-32E21	YW1S-33E21	
	2	NC		■						
	3	NO			●					
1NO-2NC (12)	1	NC		■		YW1S-3E12	YW1S-31E12	YW1S-32E12	YW1S-33E12	
	2	NO	●							
	3	NC		■						

# ø22 YW Series Selector Switches

## Selector Switches with Metal Bezel

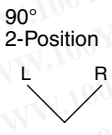
Package Quantity: 1

Shape				Knob							
											
				L	R	—					
90° 2-Position	1NO (10)	1	NO		●		YW4S-2E10	YW4S-21E10	—	—	
		2									
		3									
	1NC (01)	1			●		YW4S-2E01	YW4S-21E01	—	—	
		2									
		3	NC	●							
	2NO (20)	1	NO			●	YW4S-2E20	YW4S-21E20	—	—	
		2									
		3	NO			●					
	2NC (02)	1	NC	●			YW4S-2E02	YW4S-21E02	—	—	
		2									
		3	NC	●							
	1NO-1NC (11)	1	NO			●	YW4S-2E11	YW4S-21E11	—	—	
		2									
		3	NC	●							
	3NO (30)	1	NO			●	YW4S-2E30	YW4S-21E30	—	—	
		2	NO			●					
		3	NO			●					
3NC (03)	1	NC	●			YW4S-2E03	YW4S-21E03	—	—		
	2	NC	●								
	3	NC	●								
2NO-1NC (21)	1	NO			●	YW4S-2E21	YW4S-21E21	—	—		
	2	NC	●								
	3	NO			●						
1NO-2NC (12)	1	NO			●	YW4S-2E12	YW4S-21E12	—	—		
	2	NC	●								
	3	NC	●								
No. of Positions	Contact Configuration	Contact Block Mounting Position	Operator Position			Maintained	Spring Return from Right	Spring Return from Left	Spring Return Two-Way		
				L	C	R					
45° 3-Position	2NO (20)	1	NO	●			YW4S-3E20	YW4S-31E20	YW4S-32E20	YW4S-33E20	
		2									
		3	NO			●					
	2NO (20N1)	1			●		●	YW4S-3E20N1	YW4S-31E20N1	YW4S-32E20N1	YW4S-33E20N1
		2	NO	●							
		3	NO			●					
	2NC (02)	1	NC			■		YW4S-3E02	YW4S-31E02	YW4S-32E02	YW4S-33E02
		2									
		3	NC	■							
	2NC (02N1)	1				●		YW4S-3E02N1	YW4S-31E02N1	YW4S-32E02N1	YW4S-33E02N1
		2	NC	■							
		3	NC	■							
	1NO-1NC (11)	1	NO	●			YW4S-3E11	YW4S-31E11	YW4S-32E11	YW4S-33E11	
		2									
		3	NC	■							
	1NO-1NC (11N1)	1	NC			■	YW4S-3E11N1	YW4S-31E11N1	YW4S-32E11N1	YW4S-33E11N1	
		2									
		3	NO			●					
	1NO-1NC (11N2)	1	NO	●			YW4S-3E11N2	YW4S-31E11N2	YW4S-32E11N2	YW4S-33E11N2	
		2	NC			●					
		3									
	1NO-1NC (11N3)	1				●	YW4S-3E11N3	YW4S-31E11N3	YW4S-32E11N3	YW4S-33E11N3	
		2	NC			●					
		3	NO			●					
1NO-1NC (11N4)	1			●		●	YW4S-3E11N4	YW4S-31E11N4	YW4S-32E11N4	YW4S-33E11N4	
	2	NO	●								
	3	NC	■								
3NO (30)	1	NO			●	YW4S-3E30	YW4S-31E30	YW4S-32E30	YW4S-33E30		
	2	NO			●						
	3	NO			●						
3NC (03)	1	NC			■	YW4S-3E03	YW4S-31E03	YW4S-32E03	YW4S-33E03		
	2	NC	●								
	3	NC	■								
2NO-1NC (21)	1	NO	●			YW4S-3E21	YW4S-31E21	YW4S-32E21	YW4S-33E21		
	2	NC			●						
	3	NO			●						
1NO-2NC (12)	1	NC			■	YW4S-3E12	YW4S-31E12	YW4S-32E12	YW4S-33E12		
	2	NO	●								
	3	NC	■								

## Contact Block Mounting Position

### Selector Switch with Plastic Bezel

Contact Block  
Mounting Position

1 2 3



L C R  
Operator Position

## Dimensions

### Selector Switch with Plastic Bezel

Panel Thickness: 0.8 to 6

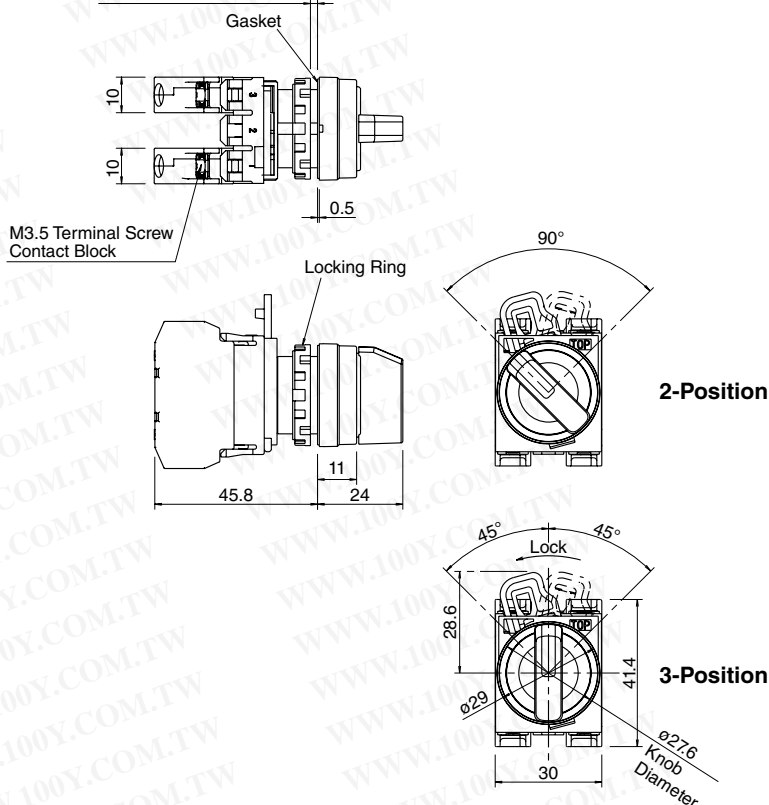

### Selector Switch with Metal Bezel

Contact Block  
Mounting Position

1 2 3



L C R  
Operator Position

### Selector Switch with Metal Bezel

Panel Thickness: 0.8 to 6

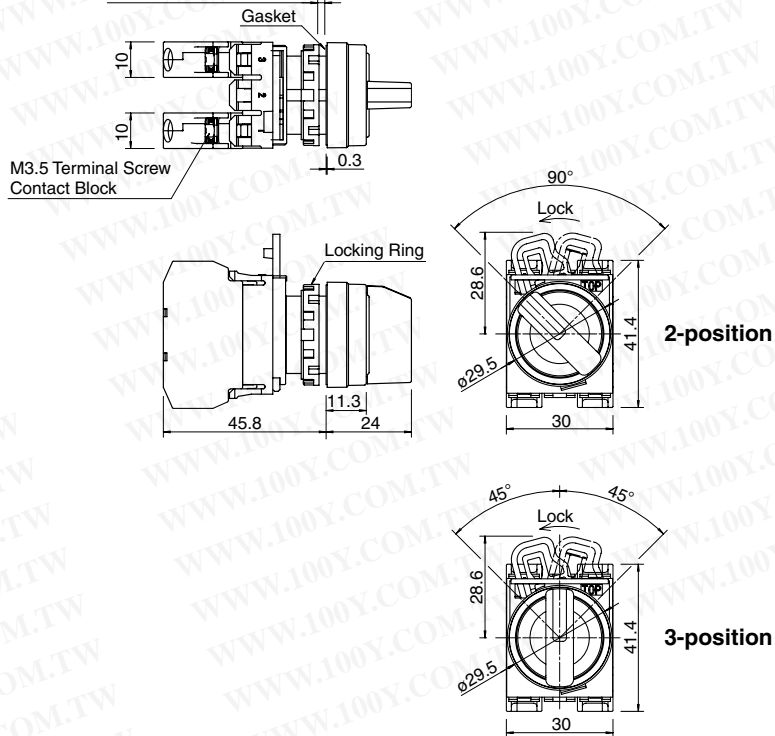



All dimensions in mm.

# ø22 YW Series Key Selector Switches

## Key Selector Switches (90° 2-Position)



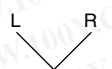
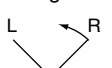





Package Quantity: 1

No. of Positions	Contact Configuration	Contact Block Mounting Position		Operator Position		Part No.		
				L	R	Plastic Bezel	Metal Bezel	
								
90° 2-position Maintained 	1NO (10)	1	NO		●	YW1K-2AE10	YW4K-2AE10	
		2						
		3						
	1NC (01)	1					YW1K-2AE01	YW4K-2AE01
		2						
		3	NC	●				
	2NO (20)	1	NO			●	YW1K-2AE20	YW4K-2AE20
		2						
		3	NO			●		
	2NC (02)	1	NC	●			YW1K-2AE02	YW4K-2AE02
		2						
		3	NC	●				
	1NO-1NC (11)	1	NO			●	YW1K-2AE11	YW4K-2AE11
		2						
		3	NC	●				
	3NO (30)	1	NO			●	YW1K-2AE30	YW4K-2AE30
		2	NO			●		
		3	NO			●		
	3NC (03)	1	NC	●			YW1K-2AE03	YW4K-2AE03
		2	NC	●				
		3	NC	●				
	2NO-1NC (21)	1	NO			●	YW1K-2AE21	YW4K-2AE21
		2	NC	●				
		3	NO			●		
1NO-2NC (12)	1	NO			●	YW1K-2AE12	YW4K-2AE12	
	2	NC	●					
	3	NC	●					
90° 2-position Spring Return from Right 	1NO (10)	1	NO		●	YW1K-21BE10	YW4K-21BE10	
		2						
		3						
	1NC (01)	1					YW1K-21BE01	YW4K-21BE01
		2						
		3	NC	●				
	2NO (20)	1	NO			●	YW1K-21BE20	YW4K-21BE20
		2						
		3	NO			●		
	2NC (02)	1	NC	●			YW1K-21BE02	YW4K-21BE02
		2						
		3	NC	●				
	1NO-1NC (11)	1	NO			●	YW1K-21BE11	YW4K-21BE11
		2						
		3	NC	●				
	3NO (30)	1	NO			●	YW1K-21BE30	YW4K-21BE30
		2	NO			●		
		3	NO			●		
	3NC (03)	1	NC	●			YW1K-21BE03	YW4K-21BE03
		2	NC	●				
		3	NC	●				
	2NO-1NC (21)	1	NO			●	YW1K-21BE21	YW4K-21BE21
		2	NC	●				
		3	NO			●		
1NO-2NC (12)	1	NO			●	YW1K-21BE12	YW4K-21BE12	
	2	NC	●					
	3	NC	●					

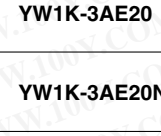
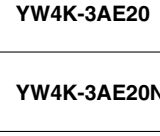
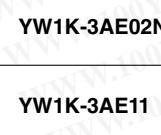
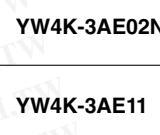
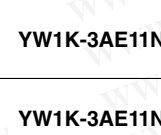
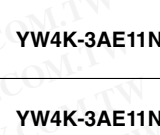
- On the spring-returned types, the key can be removed only from the maintained position. On the maintained types, the key can be removed from every position. Key retained positions are also available. See Part No. Development shown on page 21.
- Each key selector switch is supplied with two identical keys.

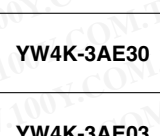
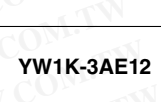
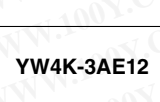
## Key Selector Switches (45° 3-Position)

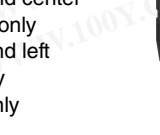
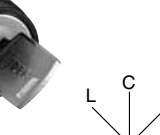
Package Quantity: 1

No. of Positions	Contact Configuration	Contact Block Mounting Position		Operator Position			Part No.		
				L	C	R	Plastic Bezel	Metal Bezel	
45° 3-position Maintained 	2NO (20)	1	NO	●			 <small>UL LISTED CE CCC</small>	 <small>UL LISTED CE CCC</small>	
		2							
		3	NO			●			
	2NO (20N1)	1						 <small>UL LISTED CE CCC</small>	 <small>UL LISTED CE CCC</small>
		2	NO	●		●			
		3	NO			●			
	2NC (02)	1	NC		▬			 <small>UL LISTED CE CCC</small>	 <small>UL LISTED CE CCC</small>
		2			▬				
		3	NC		▬				
	2NC (02N1)	1						 <small>UL LISTED CE CCC</small>	 <small>UL LISTED CE CCC</small>
		2	NC		●				
		3	NC		▬				
	1NO-1NC (11)	1	NO	●				 <small>UL LISTED CE CCC</small>	 <small>UL LISTED CE CCC</small>
		2							
		3	NC		▬				
	1NO-1NC (11N1)	1	NC			▬		 <small>UL LISTED CE CCC</small>	 <small>UL LISTED CE CCC</small>
		2							
		3	NO			●			
	1NO-1NC (11N2)	1	NO	●				 <small>UL LISTED CE CCC</small>	 <small>UL LISTED CE CCC</small>
		2	NC			●			
3									
1NO-1NC (11N3)	1						 <small>UL LISTED CE CCC</small>	 <small>UL LISTED CE CCC</small>	
	2	NC			●				
	3	NO				●			
1NO-1NC (11N4)	1						 <small>UL LISTED CE CCC</small>	 <small>UL LISTED CE CCC</small>	
	2	NO	●			●			
	3	NC		▬					
3NO (30)	1	NO	●				 <small>UL LISTED CE CCC</small>	 <small>UL LISTED CE CCC</small>	
	2	NO	●			●			
	3	NO				●			
3NC (03)	1	NC		▬			 <small>UL LISTED CE CCC</small>	 <small>UL LISTED CE CCC</small>	
	2	NC			●				
	3	NC		▬					
2NO-1NC (21)	1	NO	●				 <small>UL LISTED CE CCC</small>	 <small>UL LISTED CE CCC</small>	
	2	NC			●				
	3	NO				●			
1NO-2NC (12)	1	NC			▬		 <small>UL LISTED CE CCC</small>	 <small>UL LISTED CE CCC</small>	
	2	NO	●			●			
	3	NC		▬					

- On the maintained types, the key can be removed from every position. Key retained positions are also available. See Part No. Development below.
- Each key selector switch is supplied with two identical keys.

### Part No. Development

**YW1K-2 A E21**

 Key removal position code  
 2-position

- A: Removable in all positions
- B: Removable in left only
- C: Removable in right only

3-position

- A: Removable in all positions
- B: Removable in left and center
- C: Removable in right and center
- D: Removable in center only
- E: Removable in right and left
- G: Removable in left only
- H: Removable in right only

### Contact Block Mounting Position

Contact Block Mounting Position



















Operator Position

# ø22 YW Series Key Selector Switches

## Key Selector Switches (45° 3-Position)



Package Quantity: 1

No. of Positions	Contact Configuration	Contact Block Mounting Position		Operator Position			Part No.			
				L	C	R	Plastic Bezel	Metal Bezel		
										
45° 3-position Spring Return from Right 	2NO (20)	1	NO	●				YW1K-31BE20	YW4K-31BE20	
		2								
		3	NO			●				
	2NO (20N1)	1							YW1K-31BE20N1	YW4K-31BE20N1
		2	NO	●		●				
		3	NO			●				
	2NC (02)	1	NC			■			YW1K-31BE02	YW4K-31BE02
		2								
		3	NC	■						
	2NC (02N1)	1							YW1K-31BE02N1	YW4K-31BE02N1
		2	NC		●					
		3	NC	■						
	1NO-1NC (11)	1	NO	●					YW1K-31BE11	YW4K-31BE11
		2								
		3	NC	■						
	1NO-1NC (11N1)	1	NC			■			YW1K-31BE11N1	YW4K-31BE11N1
		2								
		3	NO			●				
	1NO-1NC (11N2)	1	NO	●					YW1K-31BE11N2	YW4K-31BE11N2
		2	NC		●					
3										
1NO-1NC (11N3)	1							YW1K-31BE11N3	YW4K-31BE11N3	
	2	NC		●						
	3	NO			●					
1NO-1NC (11N4)	1							YW1K-31BE11N4	YW4K-31BE11N4	
	2	NO	●		●					
	3	NC	■							
3NO (30)	1	NO	●					YW1K-31BE30	YW4K-31BE30	
	2	NO	●		●					
	3	NO			●					
3NC (03)	1	NC			■			YW1K-31BE03	YW4K-31BE03	
	2	NC		●						
	3	NC	■							
2NO-1NC (21)	1	NO	●					YW1K-31BE21	YW4K-31BE21	
	2	NC		●						
	3	NO			●					
1NO-2NC (12)	1	NC			■			YW1K-31BE12	YW4K-31BE12	
	2	NO	●		●					
	3	NC	■							

- On the spring-returned types, the key can be removed only from the maintained position. Key retained positions are also available. See Part No. Development shown on page 21.
- Each key selector switch is supplied with two identical keys.

## Key Selector Switches (45° 3-Position)

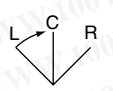
Package Quantity: 1





No. of Positions	Contact Configuration	Contact Block Mounting Position		Operator Position			Part No.		
				L	C	R	Plastic Bezel	Metal Bezel	
45° 3-position Spring Return from Left  	2NO (20)	1	NO	●			 <small>UL LISTED CE CCC</small> <b>YW1K-32CE20</b>	 <small>UL LISTED CE CCC</small> <b>YW4K-32CE20</b>	
		2							
		3	NO			●			
	2NO (20N1)	1						<b>YW1K-32CE20N1</b>	<b>YW4K-32CE20N1</b>
		2	NO	●		●			
		3	NO			●			
	2NC (02)	1	NC		■			<b>YW1K-32CE02</b>	<b>YW4K-32CE02</b>
		2							
		3	NC	■					
	2NC (02N1)	1						<b>YW1K-32CE02N1</b>	<b>YW4K-32CE02N1</b>
		2	NC		●				
		3	NC	■					
	1NO-1NC (11)	1	NO	●				<b>YW1K-32CE11</b>	<b>YW4K-32CE11</b>
		2							
		3	NC	■					
	1NO-1NC (11N1)	1	NC		■			<b>YW1K-32CE11N1</b>	<b>YW4K-32CE11N1</b>
		2							
		3	NO			●			
	1NO-1NC (11N2)	1	NO	●				<b>YW1K-32CE11N2</b>	<b>YW4K-32CE11N2</b>
		2	NC		●				
3									
1NO-1NC (11N3)	1						<b>YW1K-32CE11N3</b>	<b>YW4K-32CE11N3</b>	
	2	NC		●					
	3	NO			●				
1NO-1NC (11N4)	1						<b>YW1K-32CE11N4</b>	<b>YW4K-32CE11N4</b>	
	2	NO	●		●				
	3	NC	■						
3NO (30)	1	NO	●				<b>YW1K-32CE30</b>	<b>YW4K-32CE30</b>	
	2	NO	●		●				
	3	NO			●				
3NC (03)	1	NC		■			<b>YW1K-32CE03</b>	<b>YW4K-32CE03</b>	
	2	NC		●					
	3	NC	■						
2NO-1NC (21)	1	NO	●				<b>YW1K-32CE21</b>	<b>YW4K-32CE21</b>	
	2	NC		●					
	3	NO			●				
1NO-2NC (12)	1	NC		■			<b>YW1K-32CE12</b>	<b>YW4K-32CE12</b>	
	2	NO	●		●				
	3	NC	■						

- On the spring-returned types, the key can be removed only from the maintained position. Key retained positions are also available. See Part No. Development shown on page 21.
- Each key selector switch is supplied with two identical keys.

# ø22 YW Series Key Selector Switches

## Key Selector Switches (45° 3-Position)

Package Quantity: 1

No. of Positions	Contact Configuration	Contact Block Mounting Position		Operator Position			Part No.		
				L	C	R	Plastic Bezel	Metal Bezel	
									
45° 3-position Spring Return Two-way 	2NO (20)	1	NO	●					
		2							
		3	NO			●			
	2NO (20N1)	1						YW1K-33DE20N1	YW4K-33DE20N1
		2	NO	●		●			
		3	NO			●			
	2NC (02)	1	NC			■		YW1K-33DE02	YW4K-33DE02
		2							
		3	NC	■					
	2NC (02N1)	1						YW1K-33DE02N1	YW4K-33DE02N1
		2	NC		●				
		3	NC	■					
	1NO-1NC (11)	1	NO	●				YW1K-33DE11	YW4K-33DE11
		2							
		3	NC	■					
	1NO-1NC (11N1)	1	NC			■		YW1K-33DE11N1	YW4K-33DE11N1
		2							
		3	NO			●			
	1NO-1NC (11N2)	1	NO	●				YW1K-33DE11N2	YW4K-33DE11N2
		2	NC		●				
3									
1NO-1NC (11N3)	1						YW1K-33DE11N3	YW4K-33DE11N3	
	2	NC		●					
	3	NO			●				
1NO-1NC (11N4)	1						YW1K-33DE11N4	YW4K-33DE11N4	
	2	NO	●		●				
	3	NC	■						
3NO (30)	1	NO	●				YW1K-33DE30	YW4K-33DE30	
	2	NO	●		●				
	3	NO			●				
3NC (03)	1	NC			■		YW1K-33DE03	YW4K-33DE03	
	2	NC		●					
	3	NC	■						
2NO-1NC (21)	1	NO	●				YW1K-33DE21	YW4K-33DE21	
	2	NC		●					
	3	NO			●				
1NO-2NC (12)	1	NC			■		YW1K-33DE12	YW4K-33DE12	
	2	NO	●		●				
	3	NC	■						

- On the spring-returned types, the key can be removed only from the maintained position. Key retained positions are also available. See Part No. Development shown on page 21.
- Each key selector switch is supplied with two identical keys.

## Dimensions (Key Selector Switch)

### Plastic Bezel

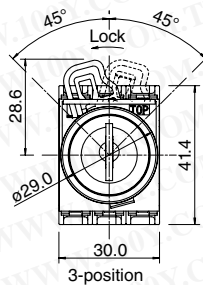
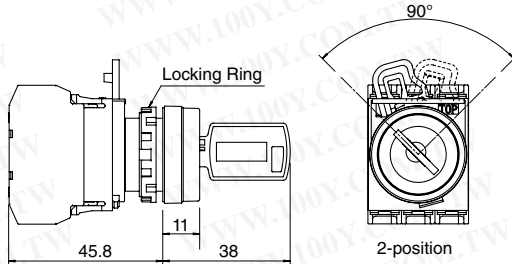
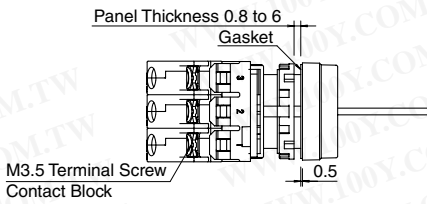



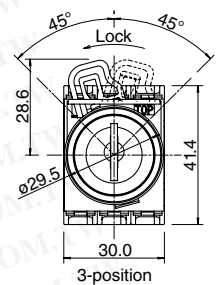
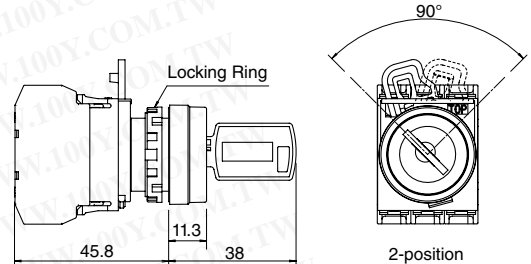
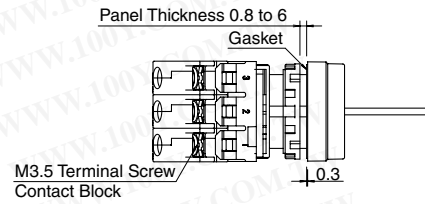



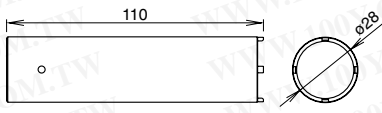

### Metal Bezel

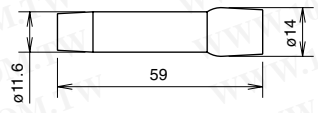

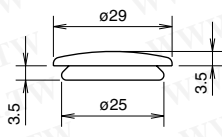
All dimensions in mm.

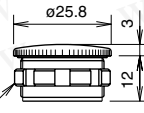

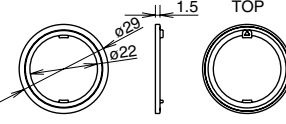



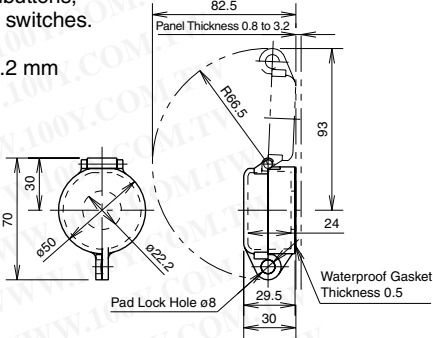

## Accessories

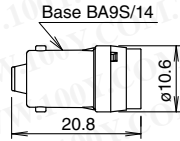
Name & Shape	Part No.	Description & Dimensions (mm)	Package Quantity
	<b>MW9Z-T1</b>	Metallic tool used to tighten the plastic locking ring when installing the YW series in a panel. 	1
	<b>OR-55</b>	Made of rubber. Used for replacing lamps. 	1
	<b>OB-31PN05</b>	Used for plugging unused mounting holes in the panel. Color: Black 	5
	<b>LW9Z-BM</b>	Used for plugging unused mounting holes in the panel. Weight: Approx. 18g 	1
	<b>HW9Z-RLPN10</b>	Prevents rotation of switches in panel. Mainly used with selector switches when no nameplate is used. With waterproof gasket (IP65). Made of plastic (black). Applicable panel thickness: 1.2 to 4.5 mm 	10

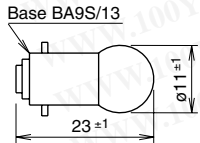
# ø22 YW Series Accessories / Maintenance Parts

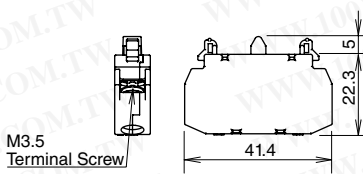
Name & Shape	Part No.	Description & Dimensions (mm)	Package Quantity
	<b>HW9Z-KL1</b>	Plastic hinged cover to protect pushbuttons, illuminated pushbuttons, or selector switches. Degree of protection: IP65. Applicable panel thickness: 0.8 to 3.2 mm 	1

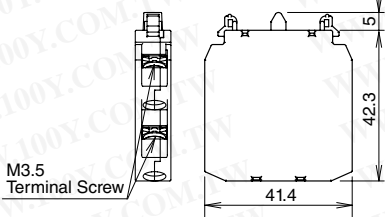
## Maintenance Parts

Name & Shape	Part No.	Description & Dimensions (mm)		Package Quantity	
	<b>LSED-6</b> Ⓜ	6V AC/DC	Specify a color code in place of Ⓜ in the Part No.: A (amber), G (green), PW (pure white), R (red), S (blue), Y (yellow)  See page 4 for applicable units and rated current.  Note: Yellow LED lamps are used for white illumination of pilot lights and illuminated pushbuttons.		1
	<b>LSED-1</b> Ⓜ	12V AC/DC			
	<b>LSED-2</b> Ⓜ	24V AC/DC			
	<b>LSED-H</b> Ⓜ	110V/120V AC/DC			
	<b>LSED-M3</b> Ⓜ	230/240V AC/DC			
	<b>LS-T6P</b>	6.3V, 1W	One pack contains 100 incandescent lamps.		100
	<b>LS-T8P</b>	18V, 1W			
	<b>LS-T3P</b>	30V, 1W			
	<b>YW-E10</b>	Contact: 1NO	Color: blue		10
	<b>YW-E01</b>	Contact: 1NC	Color: reddish purple		
	<b>YW-EW20</b>	Contact: 2NO	Color: blue		10
	<b>YW-EW02</b>	Contact: 2NC	Color: reddish purple		
	<b>YW-EW11</b>	Contact: 1NO-1NC	Color: blue and reddish purple		
	<b>YW9Z-SK00PN02</b>			2	

**Buttons, Lenses, and Marking Plates**

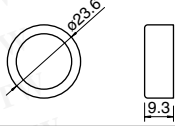
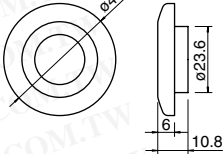
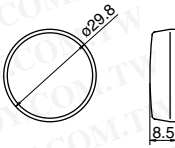
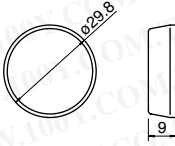
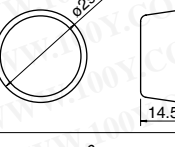
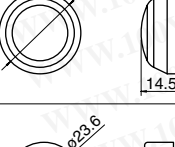
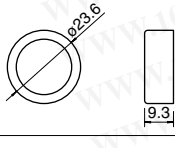
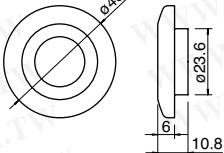
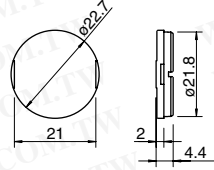
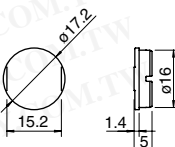
Name	Style	Part No.	① ② Color Code	Dimensions (mm)	Package Quantity
Button (for pushbuttons)	Extended	<b>YW9Z-B12①PN10</b>	B: black G: green R: red S: blue W: white Y: yellow		10
	Mushroom ø40mm	<b>YW9Z-B14①PN10</b>			
Lens (for pilot lights)	Flush	<b>YW9Z-PL11②PN10</b>	A: amber C: clear G: green R: red S: blue W: white Y: yellow		10
	Flush Marking	<b>YW9Z-PL11B②PN10</b>	A: amber C: clear G: green R: red S: blue Y: yellow		10
	Extended	<b>YW9Z-PL12T②PN10</b>	A: amber C: clear G: green R: red S: blue W: white Y: yellow		10
	Dome	<b>YW9Z-PL12②PN10</b>	A: amber C: clear G: green R: red S: blue Y: yellow		10
Lens (for illuminated pushbuttons)	Extended	<b>YW9Z-L12②PN10</b>	A: amber C: clear G: green R: red S: blue Y: yellow		10
	Mushroom ø40mm	<b>YW9Z-L14②PN10</b>			
Marking Plate (for pilot lights)	—	<b>YW9Z-PP12PN10</b>	—		10
Marking Plate (for illuminated pushbuttons)	—	<b>YW9Z-P12PN10</b>	—		10

**Nameplates**

**HWAM, HWAQ, HWAS, and HWAV**

Name	Legend	Material	Part No.	Ordering No.	Package Quantity	Dimensions (mm)
HWAM	Order marking plate separately.	Plastic (black) 1.5 mm thick	HWAM	HWAM	1	
				HWAMPN10	10	
HWAQ	Order marking plate separately.	Plastic (black) 1.5 mm thick	HWAQ	HWAQ	1	
				HWAQPN10	10	
HWAQ	Blank	Plastic (black) 1.5 mm thick	HWAS-0	HWAS-0	1	
				HWAS-0PN10	10	
HWAV	Blank	Plastic (yellow) 1.5 mm thick	HWAV-0	HWAV-0	1	
	EMERGENCY STOP			HWAV-27	1	

**Making Plate**

Description	Material	Part No.	Ordering No.	Package Quantity	Dimensions (mm)
HWNP	Aluminum (black) 1.0 mm thick	HWNP-*	HWNP-*	1	<p>• White legend on black background.</p>
			HWNP-*PN10	10	

• Specify a legend code in place of \* in the Ordering No.

**Legends**

Code	Legend
0	(blank)
1	ON
2	OFF
3	START
4	STOP
31	OFF-ON
35	HAND-AUTO
53	HAND-OFF-AUTO

• Installing the marking plate on a nameplate

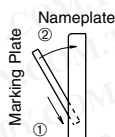

• To remove the marking plate, insert the flat screwdriver between the marking plate and nameplate.

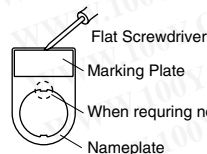







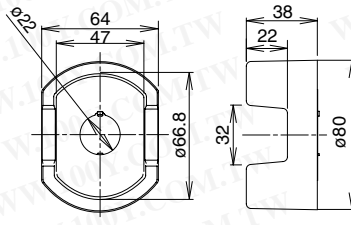

When requiring no anti-rotation, remove the projection using pliers.

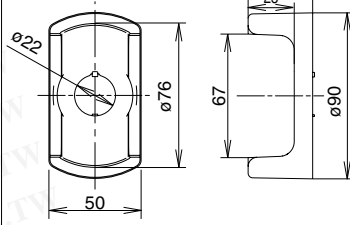
Note: When using an nameplate, the mounting panel thickness is decreased by 1.5 mm.

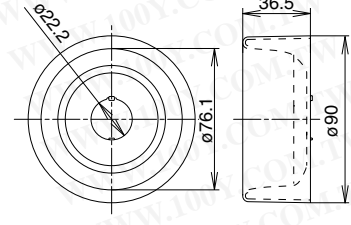
**Switch Guards**

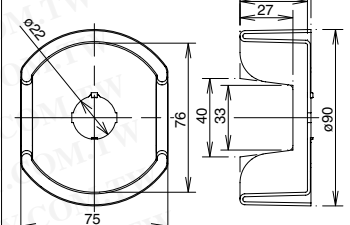
Package Quantity: 1

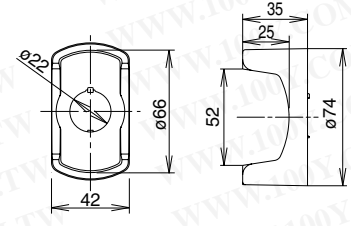
Part No. & Shape (mm)	Dimensions	Part No. & Shape	Dimensions (mm)
 HW9Z-KG1 EMO Switch Guard SEMI S2 compliant (Note 1)		 HW9Z-KG4 EMO Switch Guard SEMI S2 compliant (Note 2) SEMATECH compliant (Note 3)	
 HW9Z-KG2 EMO Switch Guard SEMI S2 compliant (Note 1) SEMATECH compliant (Note 3)		 HW9Z-KG5 EMO Switch Guard SEMI S2 compliant (Note 2) SEMATECH compliant (Note 3)	
 HW9Z-KG3 EMO Switch Guard SEMI S2 compliant (Note 2)			

Material: Polyamide (PA6)  
 Color: Yellow, Munsell 2.5Y 8/10 equivalent  
 Degree of protection: IP65

• Degree of protection IP65 applies to the combination of an emergency stop switch and an EMO switch guard.

Note 1: SEMI S2-0703 12.5.1 compliant.

Note 2: The combination of IDEC's emergency stop switches and EMO switch guards are approved by TÜV Rheinland for compliance with SEMI S2 standard.

Note 3: SEMATECH Application Guide for SEMI S2-93, 12.4.c. compliant.

**Transformer**

**Din Rail Mount Transformer For 6V**



**Dimensions (mm)**

Secondary Terminal Screws M3.5  
 Primary Terminal Screws M3.5

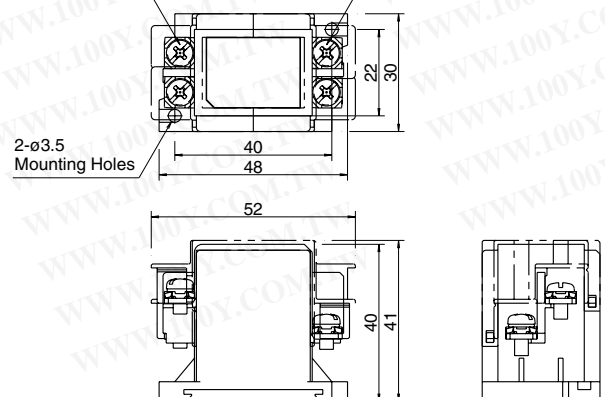

Primary Voltage (50/60 Hz)	Part No.	Applicable Lamp Rating
110V AC	<b>TWR516</b>	One full voltage type illuminated unit containing LED lamp LSED-6 (6V AC/DC) or incandescent lamp LS-T6 (6.3V)
115V AC	<b>TWR5116</b>	
120V AC	<b>TWR5126</b>	
220V AC	<b>TWR526</b>	
230V AC	<b>TWR5236</b>	
240V AC	<b>TWR5246</b>	
380V AC	<b>TWR5386</b>	
440V AC	<b>TWR546</b>	
480V AC	<b>TWR5486</b>	

Note: Finger-safe terminal cover is supplied with the transformer.

## Safety Precautions

- Turn off the power to the YW series before starting installation, removal, wiring, maintenance, and inspection of the products. Failure to turn power off may cause electrical shocks or fire hazard.
- To avoid burning your hand, use the lamp holder tool when replacing lamps.
- For wiring, use wires of a proper size to meet the voltage and

current requirements. Tighten the M3.5 terminal screws to a tightening torque of 1.0 N·m. Failure to tighten the terminal screws may cause overheating and fire.

## Instructions

### Panel Mounting

- Remove the contact block from the operator (for pilot lights, remove the transformer or full voltage unit from the pilot light). Remove the locking ring from the operator. Insert the operator into the panel cut-out from the front, tighten the locking ring from the back, then install the contact block to the operator.

### Removing and Installing the Contact Block



- ① Pull up the locking lever.
- ② Turn the lever to the left.
- ③ Pull out the contact block

1. To remove the operator from the contact block, pull up the locking lever and turn it to the left. Then the operator can be pulled out.
2. To reinstall, place the TOP marking on the operator and the TOP marking on the contact block mounting adapter in the same direction, and insert the operator into the contact block mounting adapter. Then turn the locking lever to the right.



### Removing and Installing the Transformer

1. Insert a flat screwdriver (5 mm wide at maximum) into the latch hole on the transformer unit as shown in the photo below, and disengage the latch. Then pull out the operator.
2. To reinstall, place the TOP marking on the operator and the latch in the same direction, and push the operator into the transformer.



### Removing the Full Voltage Unit

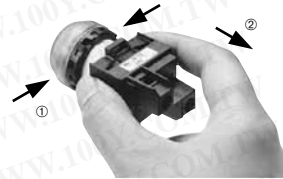

1. To remove the full voltage unit, squeeze the full voltage unit from both sides to disengage the latch as shown, and pull it out. Like the transformer unit, the full voltage unit can also be pulled out by inserting a flat screwdriver into the latch hole as shown.
2. To reinstall, place the TOP markings on the operator and the latch on the full voltage unit in the same direction, and insert the operator into the full voltage unit.

### Notes for Panel Mounting

1. Use the optional locking wrench (MW9Z-T1) to mount the operator onto a panel. Tightening torque must not exceed 2.0 N·m. Do not use pliers. Excessive tightening will damage the locking ring.
2. For contact blocks and transformers housing LED and incandescent lamps, make sure not to press the lamps too hard, otherwise the lamp socket may be damaged.

## Insertion Order of Lens and Marking Plate

### Illuminated Pushbutton

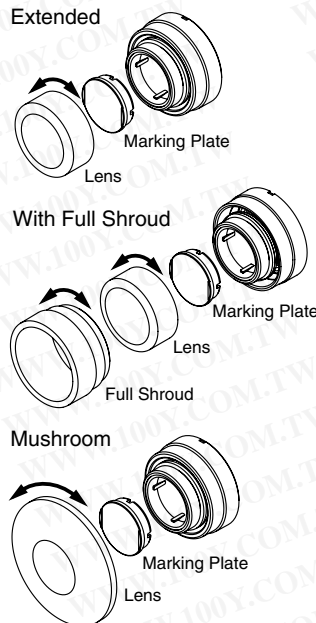

### Pilot Light

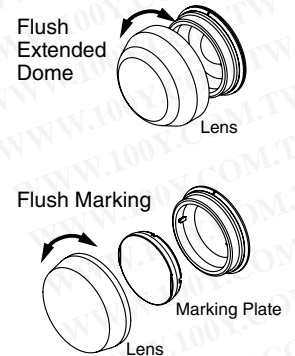

## Marking

For YW series pilot lights and illuminated pushbuttons, legends and symbols can be engraved on built-in marking plates, or printed mylar film can be inserted under the lens for labeling purposes. Mylar film is not supplied with the YW series and must be supplied by the end user.

### Built-in Marking Plate and Marking Film Size

Unit	Pilot Light	Illuminated Pushbutton
Built-in Marking Plate		
Engraving depth: 0.5 mm maximum Marking plate material: White acrylic		
Applicable Marking Film		
0.1-mm-thick x 2 sheets or 0.2-mm-thick x 1 sheet Film material: Mylar (recommended) Note: Marking film is not supplied with the pilot light or illuminated pushbutton.		

### Replacement (LED and incandescent lamps)

Lamps can be replaced using the lamp holder tool (OR-55) from the front of the panel, or by removing the contact block from the operator unit.

### Removing the Lamp from the Front of the Panel



To remove, gently insert the lamp holder tool onto the lamp head. Then push slightly, and turn the lamp holder tool to the left.

### Installing the Lamp from the Front of the Panel

- To install, insert the lamp head into the lamp holder tool, and hold the lamp as shown in the figure below.

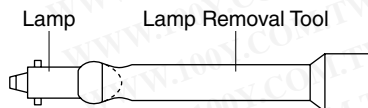

- Place the pins on the lamp base to the grooves in the lamp socket. Insert the lamp and turn it to the right.

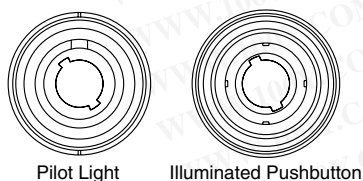

Note: LED lamps in unibody pilot lights cannot be replaced.

## Removing Contact Blocks and Full Voltage Adapters

Insert a flat screwdriver between the latch and contact block mounting adapter, and disengage the latch.

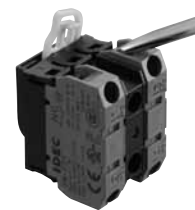

Make sure to remove the lamp and contact blocks before removing the full voltage adapter.

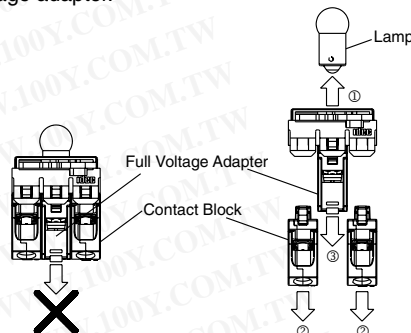

## Tightening Torque for Terminal Screws

Tighten terminal screws to a torque of 1.0 N·m.

## Anti-rotation Ring and Mounting Panel

Turn the TOP marking on the operator and the ▲ mark on the anti-rotation ring to the recess on the mounting panel.

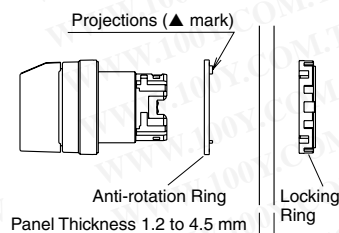

## Mounting Panel Thickness

The mounting panel must be 0.8 to 6.0 mm in thickness. When optional accessories are added, the applicable panel thickness changes as shown below.

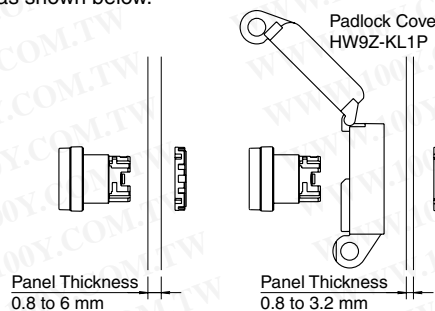

## Contact Bounce

When pressing or turning the operator, the NC and NO contacts will bounce. When designing a control circuit, take the contact bounce time into consideration (reference value: 20 ms).

## Precautions for Noise

When using the unibody pilot light in an environment where it is subjected to noise, connect a noise suppressor across terminals X1 and X2 as shown below.

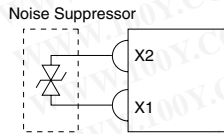

## Key Selector Switch

Before operation, ensure that the key is inserted into the key hole completely. Operating the key selector switch with a loose key will cause damage to the key selector switch.

## LED Illumination

LED lamps consist of semiconductors. If the applied voltage exceeds the rated voltage, LED elements deteriorate due to overheat, resulting in significant decrease in brightness, hue change, or failure of lighting. Also, if extraneous noise, transient voltage, or transient current is applied to the circuit, similar effects will be caused. When using LED lamps, observe the following instructions.

### Rated Voltage

The LED illuminated units are rated at 6V, 12V, 24V, 110V, or 230/240V AC/DC, and can be used within  $\pm 10\%$  the rated voltage of either AC or DC, except the 230/240V AC/DC types can be used on 250V AC/DC maximum.

### DC Power

1. Switching power supply  
 Regulated voltage from a switching power supply is best suited. Make sure to use within the rated voltage of the LED lamp.
2. Rechargeable battery  
 Note that the battery voltage may exceed the rated voltage of the LED lamp while the battery is being charged and immediately after the charging is complete. Be sure to use the LED lamp on a voltage of  $\pm 10\%$  the rated voltage, except the 230/240V AC/DC types on 250V AC/DC maximum.
3. Full-wave rectification  
 Since the LED lamp is AC/DC compatible, a diode bridge for rectification is not necessary. If the LED lamp is used on a full-wave rectification current through a diode bridge, the rectifier diodes will reduce the voltage, resulting in lower brightness.
4. Single-phase half-wave rectification  
 This is not suitable for the power source of LED lamps. Use constant-voltage DC power.

### Noise

LED elements deteriorate due to extraneous noise, resulting in significant decrease in brightness, hue change, or failure of lighting. When such effects are anticipated, take a protection measure shown below, such as RC elements or a surge absorber.

## Nameplate

When anti-rotation is not required, remove the projection from the nameplate using pliers.

## Handling

Do not expose the switch to excessive shock and vibration, otherwise the switch may be deformed or damaged, causing malfunction or operation failure.

### [Protection Example 1] For AC circuit

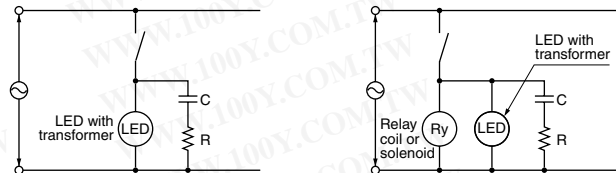

### [Protection Example 2] For DC circuit

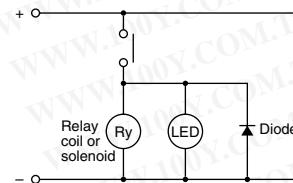

### Countermeasures against Dim Lighting

1. Leakage current through transistors or a contact protection circuit may cause the LED lamp to illuminate dimly even when the output is off.
2. When the LED lamp is illuminated by a transistor output, take the following measure.

### [Circuit Example]

Connect shunt resistor R in parallel with the LED lamp.

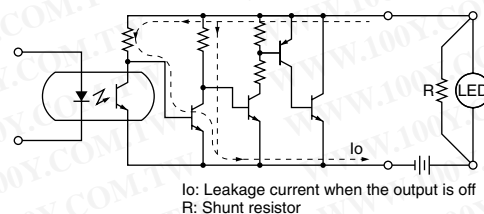

I<sub>0</sub>: Leakage current when the output is off  
 R: Shunt resistor

## Ordering Information

- When ordering, specify the Part No. and quantity.
- Replacement contact blocks are supplied in a package containing 10 pieces.

Specifications and other descriptions in this brochure are subject to change without notice.



## IDEC CORPORATION

6-64, Nishi-Miyahara 2-Chome, Yodogawa-ku, Osaka 532-0004, Japan  
 Tel: +81-6-6398-2527, Fax: +81-6-6398-2547  
 E-mail: marketing@idec.co.jp

**IDEC CORPORATION (USA)**  
 1175 Elko Drive, Sunnyvale, CA 94089-2209, USA  
 Tel: +1-408-747-0550 / (800) 262-IDEC (4332)  
 Fax: +1-408-744-9055 / (800) 635-6246  
 E-mail: opencontact@idec.com

**IDEC CANADA LIMITED**  
 3155 Pepper Mill Court, Unit 4  
 Mississauga, Ontario, L5L 4X7, Canada  
 Tel: +1-905-890-8561, Toll Free: (800) 262-IDEC (4332)  
 Fax: +1-905-890-8562  
 E-mail: sales@ca.idec.com

**IDEC AUSTRALIA PTY. LTD.**  
 Unit 17, 104 Ferntree Gully Road,  
 Oakleigh, Victoria 3166, Australia  
 Tel: +61-3-8523-5900, Toll Free: 1800-68-4332  
 Fax: +61-3-8523-5999  
 E-mail: sales@au.idec.com

**IDEC ELECTRONICS LIMITED**  
 Unit 2, Beechwood, Chineham Business Park,  
 Basingstoke, Hampshire RG24 8WA, UK  
 Tel: +44-1256-321000, Fax: +44-1256-327755  
 E-mail: sales@uk.idec.com

**IDEC ELEKTROTECHNIK GmbH**  
 Wendenstrasse 331, 20537 Hamburg, Germany  
 Tel: +49-40-25 30 54 - 0, Fax: +49-40-25 30 54 - 24  
 E-mail: service@idec.de

**IDEC (SHANGHAI) CORPORATION**  
 Room 701-702 Chong Hing Finance Center,  
 No. 288 Nanjing Road West, Shanghai 200003, PRC  
 Tel: +86-21-6135-1515  
 Fax: +86-21-6135-6225 / +86-21-6135-6226  
 E-mail: idec@cn.idec.com

**IDEC (BEIJING) CORPORATION**  
 Room 211B, Tower B, The Grand Pacific Building,  
 8A Guanghua Road, Chaoyang District,  
 Beijing 100026, PRC  
 Tel: +86-10-6581-6131, Fax: +86-10-6581-5119

**IDEC (SHENZHEN) CORPORATION**  
 Unit AB-3B2, Tian Xiang Building, Tian'an Cyber Park,  
 Fu Tian District, Shenzhen, Guang Dong 518040, PRC  
 Tel: +86-755-8356-2977, Fax: +86-755-8356-2944

**IDEC IZUMI (H.K.) CO., LTD.**  
 Unit G & H, 26/F, MG Tower,  
 No. 133 Hoi Bun Road, Kwun Tong, Kowloon,  
 Hong Kong  
 Tel: +852-2803-8989, Fax: +852-2565-0171  
 E-mail: info@hk.idec.com

**IDEC TAIWAN CORPORATION**  
 8F-1, No. 79, Hsin Tai Wu Road, Sec. 1,  
 Hsi-Chih District, 22101 New Taipei City, Taiwan  
 Tel: +886-2-2698-3929, Fax: +886-2-2698-3931  
 E-mail: service@tw.idec.com

**IDEC IZUMI ASIA PTE. LTD.**  
 No. 31, Tannery Lane #05-01,  
 HB Centre 2, Singapore 347788  
 Tel: +65-6746-1155, Fax: +65-6844-5995  
 E-mail: info@sg.idec.com

**IDEC ASIA (THAILAND) CO., LTD.**  
 Unit AB-3B2, Sorachai Bldg., No.23/78,  
 Soi Sukhumvit 63, Sukhumvit Rd.,  
 Klongton-nua, Wattana, Bangkok 10110  
 Tel: +662-392-9765, Fax: +662-392-9768  
 E-mail: sales@th.idec.com