

SNAP ACTION SWITCH

Features

- High precision basic switch in a variety of styles
- Wide margins of operating conditions increase the operating speed range
- Available in general purpose



Specifications

Item	Standard
Rating	20(4)A 250VAC EN 61058-1 15A 125VAC or 250VAC UL 1054 1/2A 125VDC 1/4A 250VDC 1/8HP 125VAC 1/4HP 250VAC
Contact Resistance	15mΩ max. (initial)
Insulation Resistance	100MΩ min.(at 500V DC)
Dielectric Strength	Between terminals of same polarity AC 1000V (50/60Hz for 1minute)
Electrically Life	100,000 operations min.
Mechanically Life	1,000,000 operations min.

Product Selection

Z15G

1

勝特力材料 886-3-5753170
 勝特力电子(上海) 86-21-34970699
 勝特力电子(深圳) 86-755-83298787
[Http://www.100y.com.tw](http://www.100y.com.tw)

1.SOLDER ACTUATOR TYPES

- 1100: Pin plunger
- 1101: Hinge lever
- 1103: Short hinge roller lever
- 1105: Slim spring plunger
- 1106: Short spring plunger
- 1107: Panel mount plunger
- 1108: Panel mount roller plunger
- 1118: Panel mount cross roller plunger
- 1501: Hinge lever
- 1502: Short Hinge lever
- 1503: Hinge roller lever
- 1504: Short hinge roller lever
- 1544: Unidirectional short hinge roller lever

SCREW ACTUATOR TYPES

- 1300: Pin plunger
- 1301: Hinge lever
- 1303: Short hinge roller lever
- 1305: Slim spring plunger
- 1306: Short spring plunger
- 1307: Panel mount plunger
- 1308: Panel mount roller plunger
- 1318: Panel mount cross roller plunger
- 1701: Hinge lever
- 1702: Short Hinge lever
- 1703: Hinge roller lever
- 1704: Short hinge roller lever
- 1744: Unidirectional short hinge roller lever

Terminals

Solder Terminal

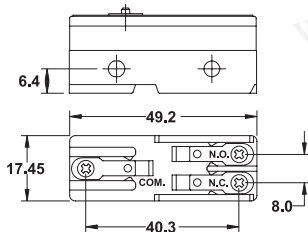

Screw Terminal

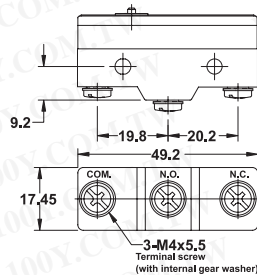

Mounting Hole

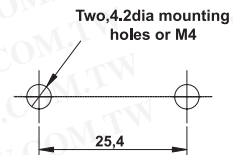

HIGHLY

B5

Design, specifications are subject to change without notice.

SNAP ACTION SWITCH

Operating Characteristics

Unit: mm

Item

Operating Characteristics

Dimensions

Z15G1300



Terminal	Item No.
Solder	Z15G1100
Screw	Z15G1300
OF	250—350g
RF min.	114g
PT max.	0.4 mm
OT min.	0.13 mm
MD max.	0.05 mm
OP	15.9±0.4 mm

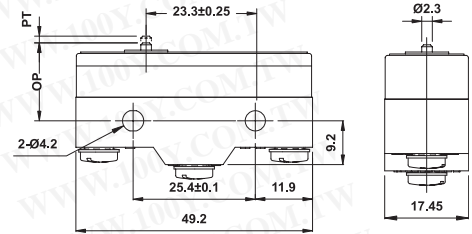

Z15G1301



Terminal	Item No.
Solder	Z15G1101
Screw	Z15G1301
OF max.	141g
RF min.	14g
PT max.	4 mm*
OT min.	1.6 mm
MD max.	1.3 mm
FP max.	20.6 mm
OP	17.4±0.8 mm

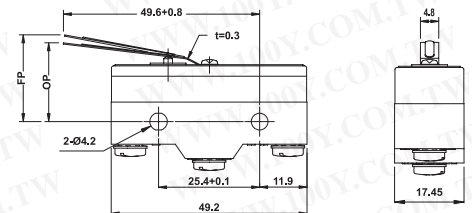

Z15G1303



Terminal	Item No.
Solder	Z15G1103
Screw	Z15G1303
OF max.	141g
RF min.	14g
PT max.	4 mm*
OT min.	1.6 mm
MD max.	1.3 mm
FP max.	31.8 mm
OP	28.6±0.8 mm

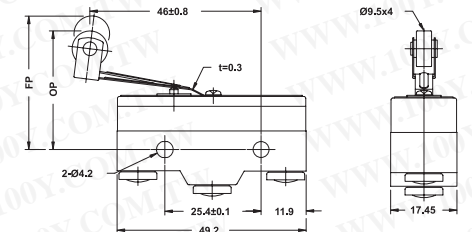

Z15G1305



Terminal	Item No.
Solder	Z15G1105
Screw	Z15G1305
OF	250—350g
RF min.	114g
PT max.	0.4 mm
OT min.	1.6 mm
MD max.	0.05 mm
OP	28.2±0.5 mm

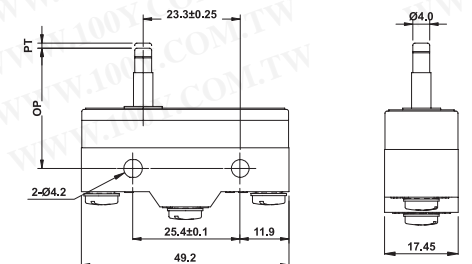

勝特力材料 886-3-5753170
 勝特力电子(上海) 86-21-34970699
 勝特力电子(深圳) 86-755-83298787
[Http://www.100y.com.tw](http://www.100y.com.tw)

HIGHLY

B6

Design, specifications are subject to change without notice.

SNAP ACTION SWITCH

Operating Characteristics

Unit: mm

Item

Operating Characteristics

Dimensions

Z15G1306



Terminal	Item No.
Solder	Z15G1106
Screw	Z15G1306
OF	250—350g
RF min.	114g
PT max.	0.4 mm
OT min.	1.6 mm
MD max.	0.05 mm
OP	21.5±0.5 mm

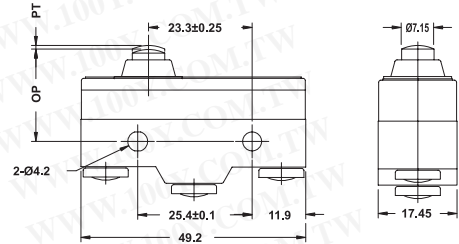

Z15G1307



Terminal	Item No.
Solder	Z15G1107
Screw	Z15G1307
OF	250—350g
RF min.	114g
PT max.	0.4 mm
OT min.	5.5 mm
MD max.	0.05 mm
OP	21.8±0.8 mm

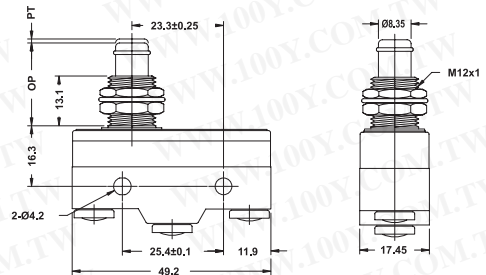

Z15G1308



Terminal	Item No.
Solder	Z15G1108
Screw	Z15G1308
OF	250—350g
RF min.	114g
PT max.	0.4 mm
OT min.	3.58 mm
MD max.	0.05 mm
OP	33.4±1.2mm

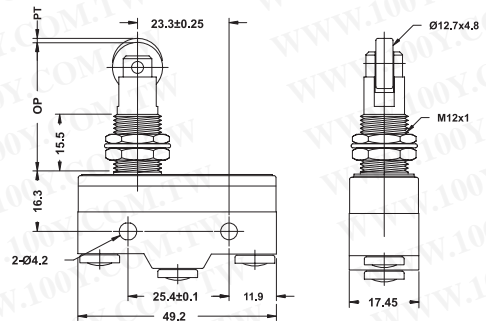

Z15G1318



Terminal	Item No.
Solder	Z15G1118
Screw	Z15G1318
OF	250—350g
RF min.	114g
PT max.	0.4 mm
OT min.	3.58 mm
MD max.	0.05 mm
OP	33.4±1.2 mm

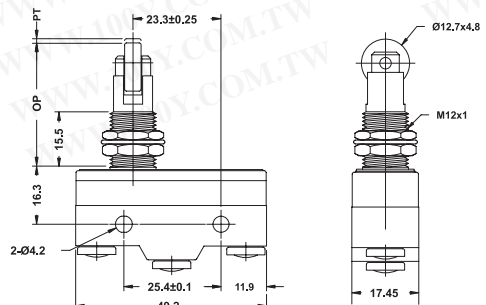

勝特力材料 886-3-5753170
 勝特力电子(上海) 86-21-34970699
 勝特力电子(深圳) 86-755-83298787
[Http://www.100y.com.tw](http://www.100y.com.tw)

HIGHLY

B7

Design, specifications are subject to change without notice.

SNAP ACTION SWITCH

Operating Characteristics

Unit: mm

Item

Operating Characteristics

Dimensions

Z15G1701



Terminal	Item No.
Solder	Z15G1501
Screw	Z15G1701
OF max.	70g
RF min.	14g
PT max.	10 mm*
OT min.	5.6 mm
MD max.	1.27 mm
FP max.	28.2 mm
OP	19±0.8 mm

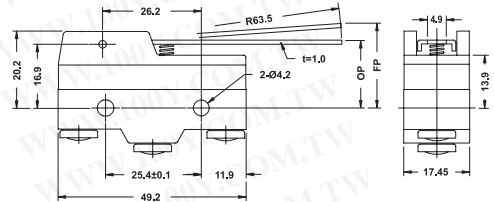

Z15G1702



Terminal	Item No.
Solder	Z15G1502
Screw	Z15G1702
OF max.	90g
RF min.	18g
PT max.	7 mm
OT min.	3.5 mm
MD max.	1 mm
FP max.	26.2 mm
OP	19.8±0.8 mm

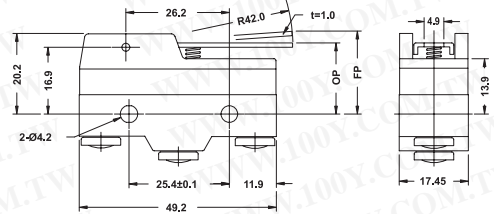

Z15G1703



Terminal	Item No.
Solder	Z15G1503
Screw	Z15G1703
OF max.	100g
RF min.	22g
PT max.	7.1 mm
OT min.	4 mm
MD max.	1.02 mm
FP max.	36.5 mm
OP	30.2±0.8mm

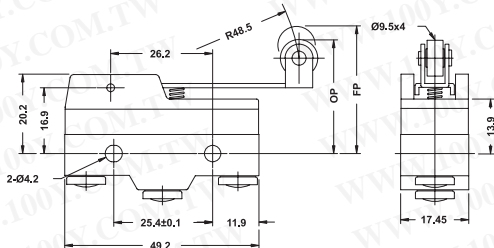

Z15G1704



Terminal	Item No.
Solder	Z15G1504
Screw	Z15G1704
OF max.	160g
RF min.	42g
PT max.	2.7 mm
OT min.	2.4 mm
MD max.	0.5 mm
FP max.	32.5 mm
OP	30.2±0.4mm

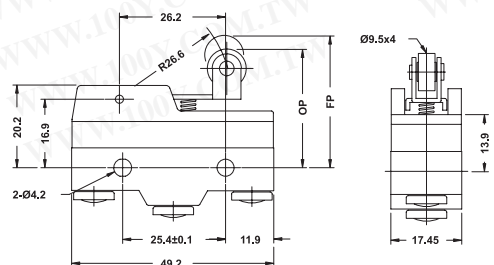

勝特力材料 886-3-5753170
 勝特力电子(上海) 86-21-34970699
 勝特力电子(深圳) 86-755-83298787
[Http://www.100y.com.tw](http://www.100y.com.tw)

HIGHLY

B8

Design, specifications are subject to change without notice.

SNAP ACTION SWITCH

Operating Characteristics

Unit: mm

Item

Operating Characteristics

Dimensions

Z15G1744



Terminal	Item No.
Solder	Z15G1544
Screw	Z15G1744
OF max.	170g
RF min.	42g
PT max.	2.7 mm*
OT min.	2.4 mm
MD max.	0.51 mm
FP max.	43.6 mm
OP	41.3±0.8 mm

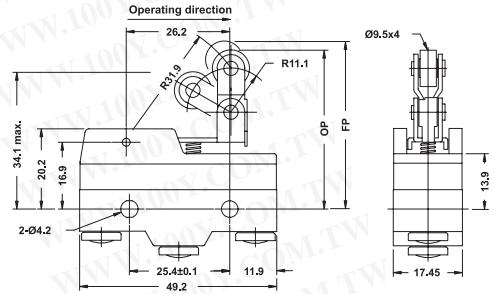

ZP15G1306



Terminal	Item No.
Solder	ZP15G1106
Screw	ZP15G1306
OF max.	540g
RF min.	114g
PT max.	2.3 mm
OT min.	1.6 mm
MD max.	0.06 mm
OP	28.2±0.5 mm

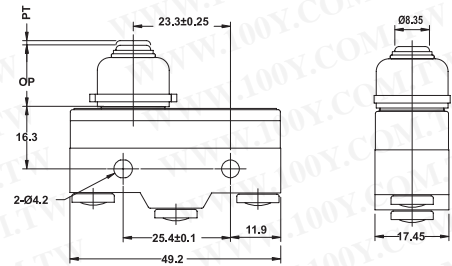

TERMINAL ENCLOSURES AA8000

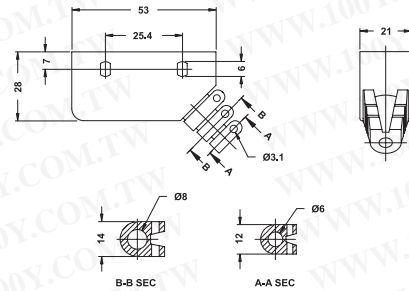

勝特力材料 886-3-5753170
 勝特力电子(上海) 86-21-34970699
 勝特力电子(深圳) 86-755-83298787
[Http://www.100y.com.tw](http://www.100y.com.tw)

HIGHLY

B9

Design, specifications are subject to change without notice.