

Ultra Compact and Versatile Filtered Power Entry Module

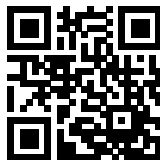

- Dual stage filter
- Ultra compact design
- Rated currents up to 10 A
- Dual fuse holder
- 2-pole rocker switch
- Good attenuation performance
- Faston or spring cage terminals



Performance indicators

Attenuation performance



Rated current [A]



勝特力材料 886-3-5753170
 勝特力电子(上海) 86-21-34970699
 勝特力电子(深圳) 86-755-83298787
[Http://www.100y.com.tw](http://www.100y.com.tw)

Technical Specifications

Maximum continuous operating voltage	250 VAC, 50/60 Hz
Rated currents	1 to 10 A @ 40°C max
Operating frequency	DC to 400 Hz
Leakage current	Standard: <500 µA at 250 VAC/50 Hz Medical: <5 µA at 250 VAC/50 Hz
High potential test voltage	P -> PE 2000 VAC for 2 sec (standard types) P -> PE 2500 VAC for 2 sec (B types) P -> N 760 VAC for 2 sec
Design corresponding to	UL 1283, CSA 22.2 No. 8 1986, EN 60939, EN 60950, EN 60601-1, UL 544, EN 60320
Flammability corresponding to	UL 94 V-2 or better
Temperature range (operation and storage)	- 25°C to +85°C (25/85/21)
Protection category	IP 40 according to IEC 60529 (front side)
MTBF @ 40°C/230 V (Mil-HB-217F)	> 1,000,000 hours
Switch ratings	
Rocker switch	2-pole, dark not illuminated, Marking I - 0
USA (UL) and Canada (C-UL)	10 A, 125 VAC; 10 A, 250 VAC; 1/3 HP
Europe (ENEC)	10 A (4 A), 250 VAC*
Mechanical life	50,000 cycles
Electrical specifications	Inrush current 82 A 6,000 on-off operations according to UL 1054 10,000 on-off operations according to ENEC
Fuse holder	2 fuses (Ø5 x 20 mm) max. 250 V (certified to IEC 60127-6), power acceptance 1.6W @ Ta 23°C per pole

* Value in () relates to the inductive current charge: $\cos \gamma = 0.65$

Approvals & Compliances



(CQC except HI-types; Patent US 20110227692/US 876676; CN ZL201080069589.0)

Choosing FN 9280/90 product line brings you the rapid availability of a standard filter associated with the necessary safety acceptances and a high attenuation performance. For higher attenuation performance the FN 9290 family with a dual stage filter and identical panel cut-out can be used.

Standard IEC connector filters are a practical solution to pass EMI system approval in a short time. A wide selection of amperage ratings, mounting possibilities and also filters for medical applications are designed to offer you the best solution.

Features and Benefits

- Best conducted attenuation performance, based on chokes with high saturation resistance and excellent thermal behavior
- Deep-drawn iron-sheet housing for best possible shielding against magnetic fields
- Rear/front flange mounting or snap-in versions
- Dual and additional spare fuse holder
- 2-pole rocker switch
- Faston or spring cage terminals for more flexible assembly
- FN 929X B versions comply with the requirements of 1MOP acc. to IEC/EN 60601-1
- All versions according IEC/EN 62368-1

Typical Applications



- Portable electrical and electronic equipment
- Consumer goods
- EDP and office equipment
- Single-phase and switch-mode power supplies
- Test and measurement equipment
- Medical electrical devices (MD) and *In-Vitro-Diagnostics (IVD)* equipment
- Audio/Video, information and communication technologies

Typical electrical schematic

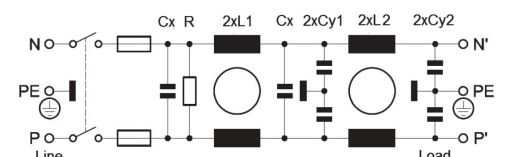
FN 9290 Standard types (B types without Cy)



Filter Selection Table

Filter*	Rated current @ 40°C	Leakage current** @ 250 VAC /50 Hz (@ 120 VAC /60 Hz)	Inductance			Capacitance			Resistance R	Output connections		Weight [g]
			L1	L2	Cx	Cy1	Cy2	[kOhm]				
	[A]	[mA]	[mH]	[mH]	[nF]	[nF]	[nF]					
FN 9290-1-..	1	0.28 (0.16)	10.9	10.9	220	1.5	0.47	1000	-06	-100	147	
FN 9290-2-..	2	0.28 (0.16)	4.4	4.4	220	1.5	0.47	1000	-06	-100	148	
FN 9290-4-..	4	0.28 (0.16)	1.7	1.7	220	1.5	0.47	1000	-06	-100	148	
FN 9290-6-..	6	0.28 (0.16)	0.78	0.78	220	1.5	0.47	1000	-06	-100	153	
FN 9290-10-..	10	0.28 (0.16)	0.32	0.32	220	1.5	0.47	1000	-06	-100	154	
FN 9290 B-1-..	1	0.00	10.9	10.9	220	0	0	1000	-06	-100	147	
FN 9290 B-2-..	2	0.00	4.4	4.4	220	0	0	1000	-06	-100	148	
FN 9290 B-4-..	4	0.00	1.7	1.7	220	0	0	1000	-06	-100	148	
FN 9290 B-6-..	6	0.00	0.78	0.78	220	0	0	1000	-06	-100	153	
FN 9290 B-10-..	10	0.00	0.32	0.32	220	0	0	1000	-06	-100	154	
FN 9299-1-..	1	0.28 (0.16)	10.9	10.9	220	1.5	0.47	1000	-06	-100	147	
FN 9299-2-..	2	0.28 (0.16)	4.4	4.4	220	1.5	0.47	1000	-06	-100	148	
FN 9299-4-..	4	0.28 (0.16)	1.7	1.7	220	1.5	0.47	1000	-06	-100	148	
FN 9299-6-..	6	0.28 (0.16)	0.78	0.78	220	1.5	0.47	1000	-06	-100	153	
FN 9299-10-..	10	0.28 (0.16)	0.32	0.32	220	1.5	0.47	1000	-06	-100	154	
FN 9299 B-1-..	1	0.00	10.9	10.9	220	0	0	1000	-06	-100	147	
FN 9299 B-2-..	2	0.00	4.4	4.4	220	0	0	1000	-06	-100	148	
FN 9299 B-4-..	4	0.00	1.7	1.7	220	0	0	1000	-06	-100	148	
FN 9299 B-6-..	6	0.00	0.78	0.78	220	0	0	1000	-06	-100	153	
FN 9299 B-10-..	10	0.00	0.32	0.32	220	0	0	1000	-06	-100	154	

* To compile a complete part number, please replace the -.. with the required output connection style (e.g. FN 9289-1-06, FN 9282-4-100)

** Maximum leakage current under normal conditions (according to IEC60939-3)

Product selector:

FN 92www-xx-yy-zz

- Blank: Snap in range 1.0 to 2.5 mm
Optional: 30: Snap in range >2.5 to 3.5 mm
- 06: Fast-On 6.3 x 0.8 mm (spade/soldering)
100: Spring cage
- 1 to 10: Rated current [A]
- Blank: Standard version
B: Medical version (without Y2-capacitor)
Optional: B: Medical version (without YZ-capacitor)
- 0: Flange version vertical/horizontal/front/rear mounting set
9: Snap-in version, snapper on horizontal side (top / bottom)
Optional: 1: Rear Flange mounting (top / bottom)
2: Front Flange mounting (top / bottom)
3: Rear Flange mounting (left / right)
4: Front Flange mounting (left / right)
8: Snap-in version, snapper on vertical side (left / right)
- 9: Dual stage filter

勝特力材料 886-3-5753170
 勝特力电子(上海) 86-21-34970699
 勝特力电子(深圳) 86-755-83298787
[Http://www.100y.com.tw](http://www.100y.com.tw)

All FN 9280/FN 9290 are equipped with a dual fuse holder with a spare fuse holder.

Note: All FN 9280/FN 9280 B/FN 9289/FN 9289 B/FN 9290/FN 9290 B/FN 9299/FN 9299 B are stock types from our distribution partners.

Order Examples:

FN 9280 B-6-100: Medical version of single stage, dual fuse EMC/EMI filter, flange set for vertical/horizontal/front/rear mounting, 6 A, spring cage terminals, from stock available.

FN 9298-6-06-30: Dual stage, dual fuse EMC/EMI filter, snap-in version, snappers for snap-in panel thickness range >2.5 to 3.5 mm, snapper on vertical side, 6 A, fast-on terminals, non-stock order type

Accessories: The 4D flanges can be ordered separately. The order number is 427532. Please note that the minimum order quantity is one box of 50 pieces. One item includes both type of flanges (vertical and horizontal).

Typical Filter Attenuation

FN 9290 Series | Typical filter attenuation | Per CISPR 17; A=50 Ω/50 Ω sym; B=50 Ω/50 Ω asym

1 A types

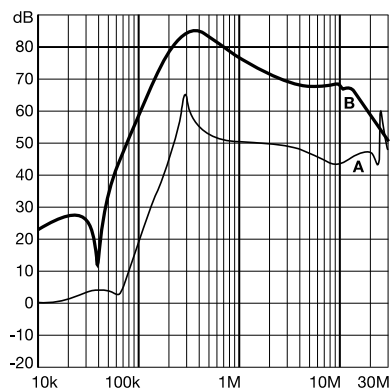

2 A types

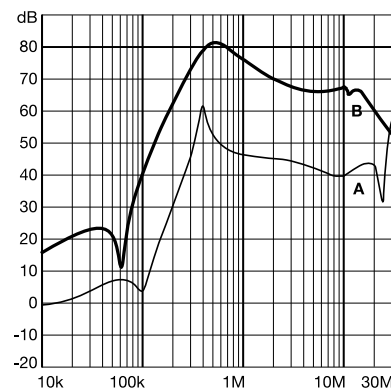

4 – 6 A types

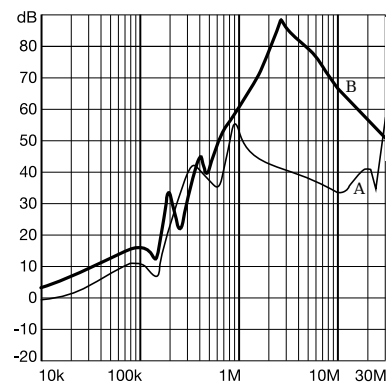

10 A types

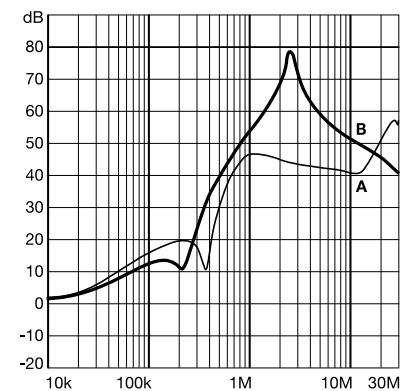

FN 9290 B Series | Typical filter attenuation | Per CISPR 17; A=50 Ω/50 Ω sym; B=50 Ω/50 Ω asym

1 A types

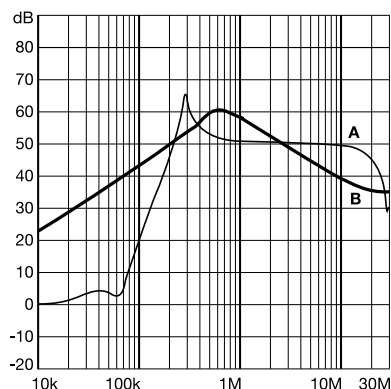

2 A types

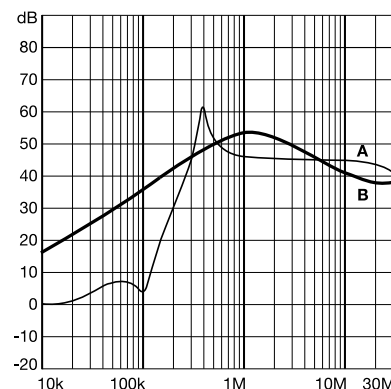

4 – 6 A types

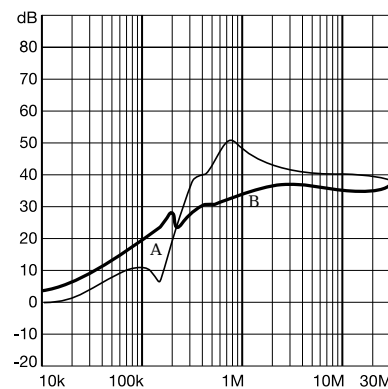

10 A types

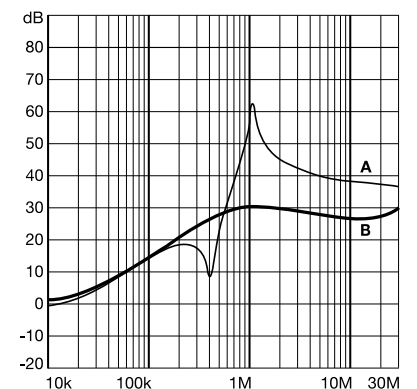

勝特力材料 886-3-5753170
 勝特力电子(上海) 86-21-34970699
 勝特力电子(深圳) 86-755-83298787
[Http://www.100y.com.tw](http://www.100y.com.tw)

Mechanical Data

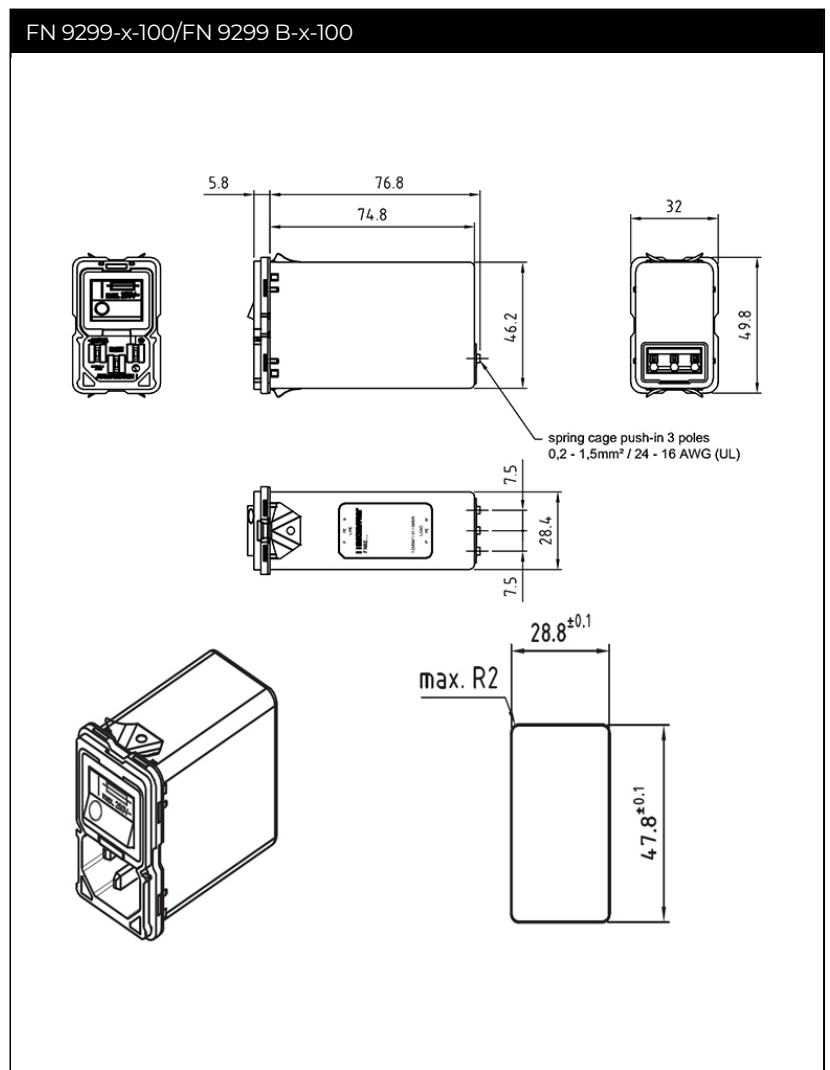
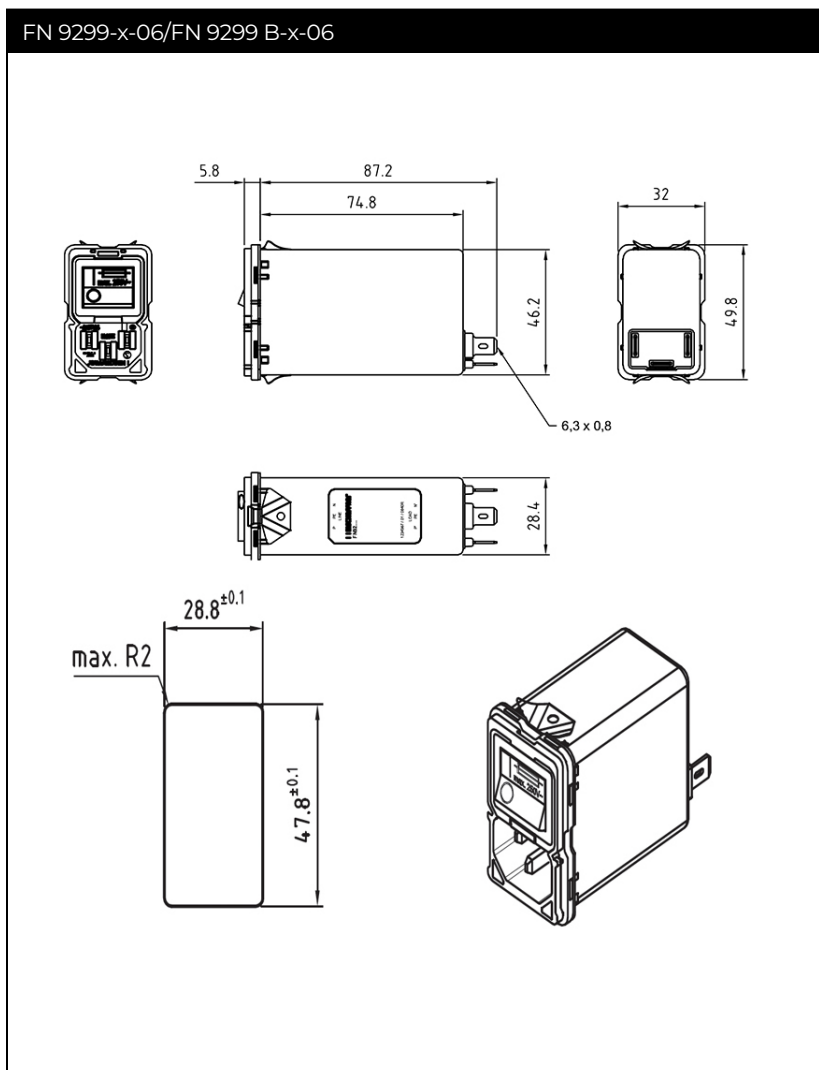
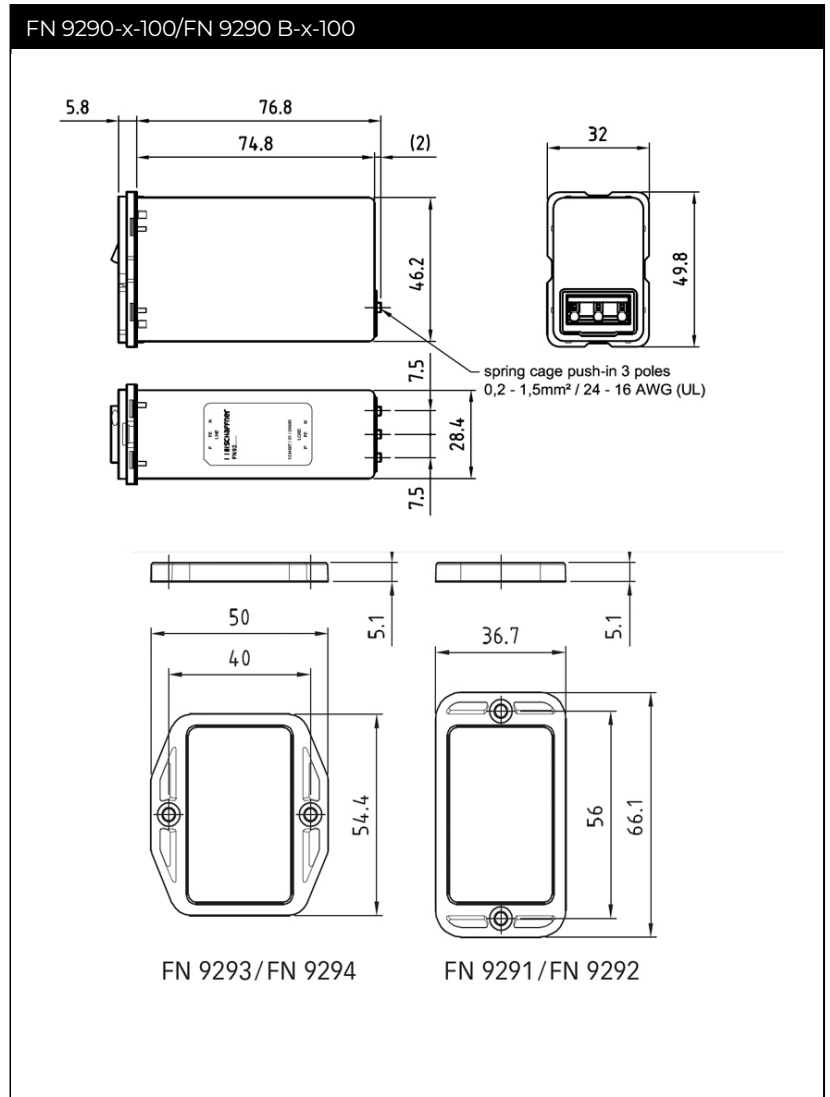
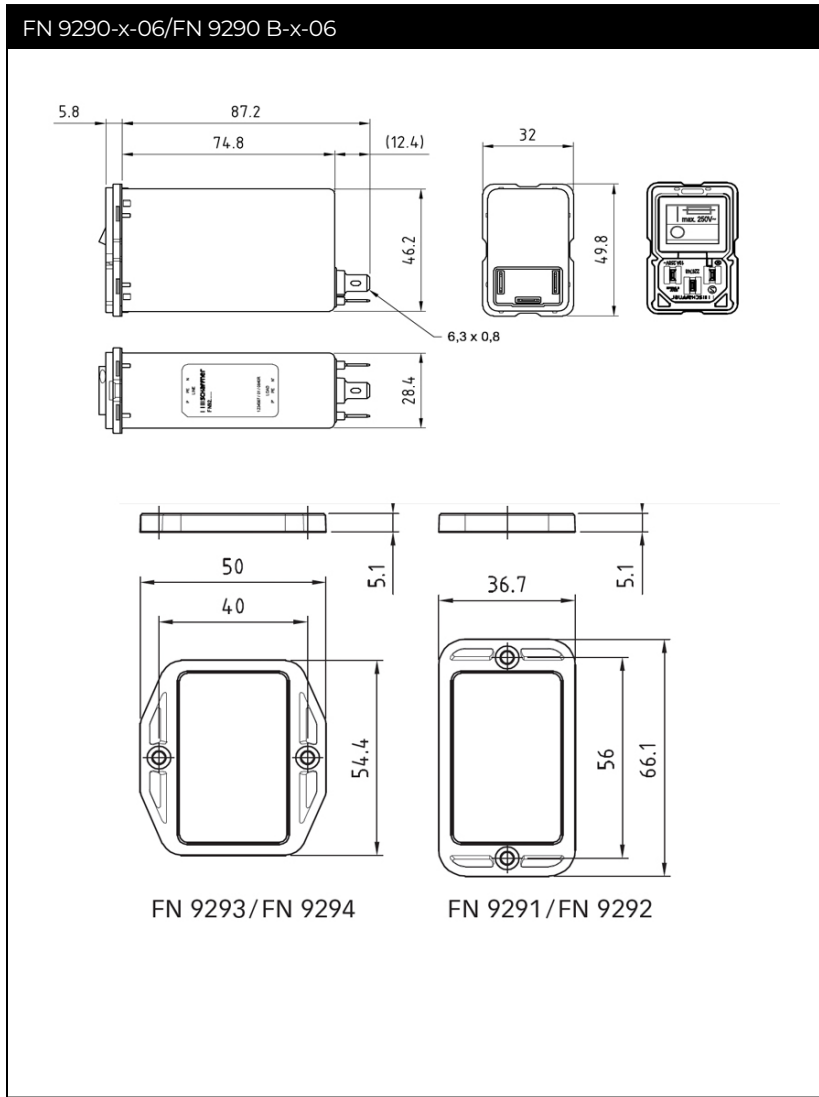

勝特力材料 886-3-5753170
 勝特力电子(上海) 86-21-34970699
 勝特力电子(深圳) 86-755-83298787
[Http://www.100y.com.tw](http://www.100y.com.tw)

Assembly Instructions

REAR MOUNTING

vertical:

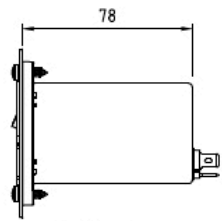

horizontal:

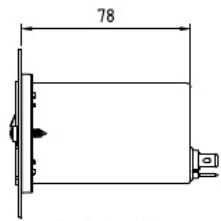

Cutout:

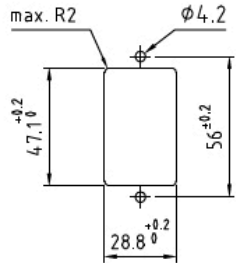

Cutout:

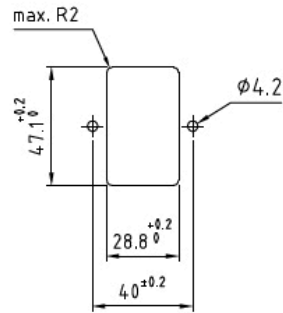

Assembly:

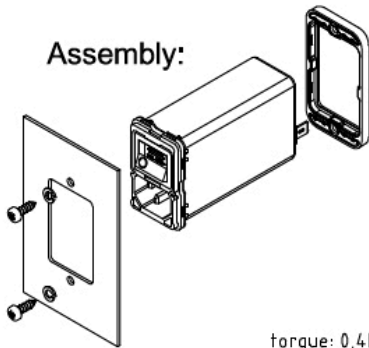

torque: 0,4Nm

Recommended screw:
Panhead tapping screw d x l 3,9 x 9,5 mm

Assembly:

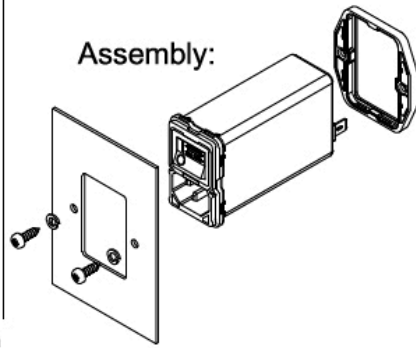

FRONT MOUNTING

vertical:

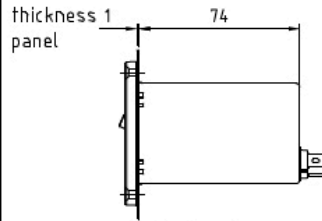

horizontal:

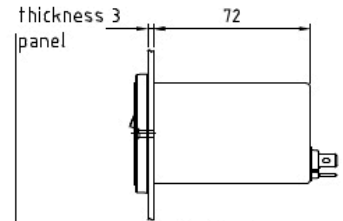

Cutout:

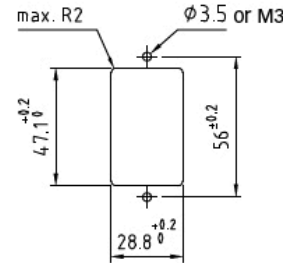

Cutout:

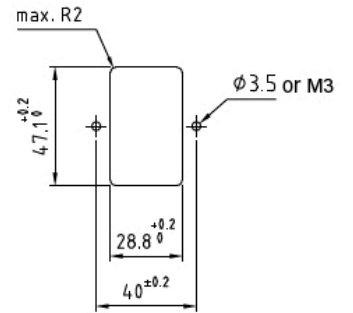

Assembly:

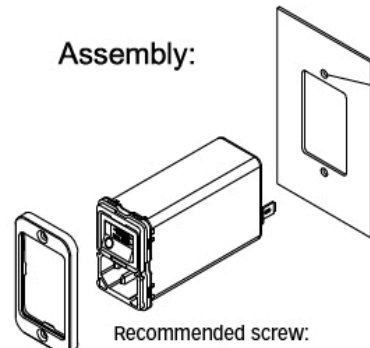

Recommended screw:
Countersunk screw M3X14 DIN963A

Assembly:

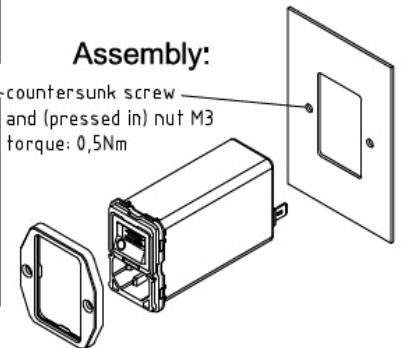

countersunk screw
and (pressed in) nut M3
torque: 0,5Nm

Terminal -100

clamping range, solid wire / flex wire

0,20 mm² – 1,5 mm², AWG24 – AWG16

operating force of slider

max. 40 N

recommended stripped length

8 mm

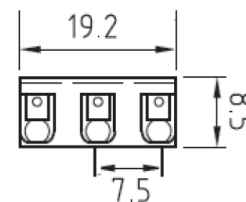

Push the knob above the terminal to insert the wire.

Removal Of The Combined Switch / Fuse Holder Unit

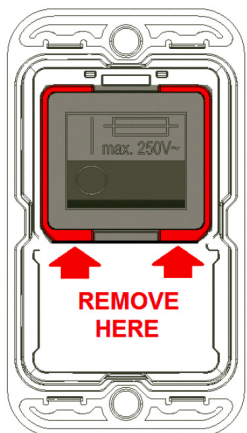

Fuses are not in the scope of delivery.

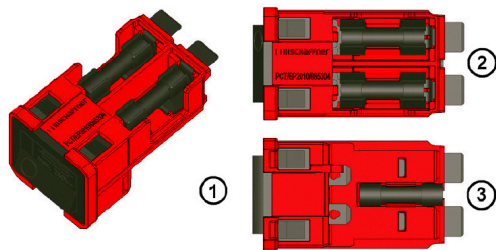

An additional fuse mark on the switch indicates the fuses holders behind the switch. The red frame shows the outline of the removable unit.

With a simple tool like a Swiss Army knife or a screwdriver No 1 or smaller the unit (1) can be removed from the filter. On the topside (2) behind the switch there are two fuse holders for each live connection. On the bottom side (3) is a clip to carry an additional spare fuse.

勝特力材料 886-3-5753170
 勝特力电子(上海) 86-21-34970699
 勝特力电子(深圳) 86-755-83298787
[Http://www.100y.com.tw](http://www.100y.com.tw)

Accessories

IL 13P IEC C13 Rewireable Connectors with Locking System



The locking system has a tensile force of typical 300N. It is recommended to use it with flange mount filters. For details refer to our Application Note "Using IEC Lock Power Cords with IEC Inlets and Filters".

Schaffner power connector with IEC lock guard against accidental disconnection of all electrical appliances with an IEC inlet. No exchange or modification of the IEC inlet or IEC inlet filter system is needed. Easy retrofit .for all electronic equipments and devices

[Technical Data Sheet >](#)

勝特力材料 886-3-5753170
 勝特力电子(上海) 86-21-34970699
 勝特力电子(深圳) 86-755-83298787
[Http://www.100y.com.tw](http://www.100y.com.tw)

IL 13P IEC C13 Rewireable Angled Connectors with Locking System



- Protects appliances that are vulnerable to vibration
- Connector cannot be accidentally pulled or vibrated out of the inlet
- Space availability/constraints
- Different angles for ease of access
- Space saving
- Release locking mechanism
- Prevents accidental disconnection

[Technical Data Sheet >](#)

Power Cord with angled Locking System C13



- Protects appliances that are vulnerable to vibration
- Connector cannot be accidentally pulled or vibrated out of the inlet
- Space availability/constraints
- Different angles for ease of access
- Space saving
- Release locking mechanism
- Prevents accidental disconnection

[Technical Data Sheet >](#)