

# Ultra-compact EMC/RFI Filter for Motor Drives Applications

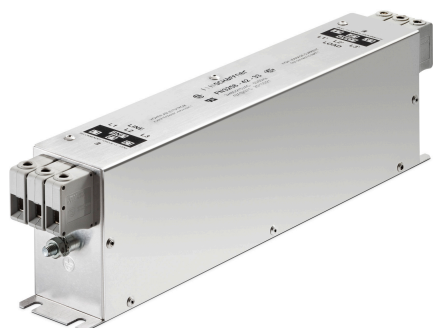

- New: solid safety connector blocks available for the whole range
- Exceptional attenuation performance from 150 kHz to 30 MHz
- Excellent saturation resistance up to 50 m cable length
- Most compact and slim filter design in its class

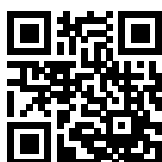

### Performance indicators

Attenuation performance



Rated current [A]

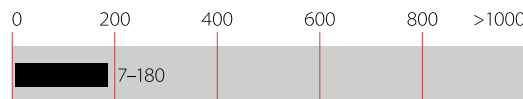

勝特力材料 886-3-5753170  
 勝特力电子(上海) 86-21-34970699  
 勝特力电子(深圳) 86-755-83298787  
[Http://www.100y.com.tw](http://www.100y.com.tw)

## Technical Specifications

<b>Maximum continuous operating voltage</b>	3x 520/300 VAC (FN 3258 H) 3x 480/277 VAC (FN 3258)
<b>Operating frequency</b>	DC to 60 Hz
<b>Rated currents</b>	7 to 180 A
<b>High potential test voltage</b>	P → E 2650 / 2750 VDC for 2 sec (FN 3258 / FN 3258H) P → P 2100 / 2250 VDC for 2 sec (FN 3258 / FN 3258H)
<b>Protection category</b>	IP 20
<b>Overload capability</b>	4x rated current at switch on, 1.5x rated current for 1 minute, once per hour
<b>Temperature range (operation and storage)</b>	-25°C to +100°C (25/100/21)
<b>Flammability corresponding to</b>	UL 94 V-2 or better
<b>Design corresponding to</b>	UL 1283, CSA 22.2 No. 8 1986, IEC/EN 60939
<b>MTBF @ 50°C/400 V (Mil-HB-217F)</b>	300,000 hours

### Approvals & Compliances



### Features and Benefits

- The extremely compact and slim filter design allows a trouble-free installation even where the available mounting space is minimal
- With new additional filter types providing safety terminal blocks, the most preferred connection style can be chosen fast and easy. This helps to stay in line with the electrical connection concept of a given application
- FN 3258 filters ensure compliance with Class A limits according to EN 55011 up to 50 m cable length and beyond. Further they can contribute significantly to meet conducted emission limits according to Class B
- Filter operation on the mains input side of consumers increases their reliability and conducted immunity significant
- Chokes with exceptional saturation resistance and excellent thermal behavior are a vital part of FN 3258 design. Thus, all filters retain the expected filter performance even in very noisy applications and under full load conditions



### Typical Applications

- Three-phase variable speed motor drives, servo drives, inverters and converters
- Applications comprising energy conversion devices like machines or process automation equipment
- HVAC equipment, elevators, power supplies, UPS and further three-phase applications

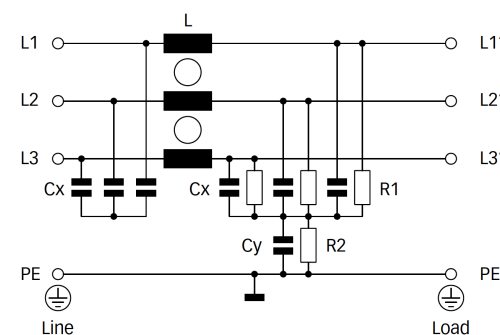
### Typical electrical schematic



### Filter Selection Table

Filter	Buy	Rated current @ 50°C (40°C) [A]	Typical drive Power Rating* [kW]	Leakage current** @ 480/520 VAC/50 Hz [mA]	Power loss @ 25°C/50 Hz [W]	Input/Output Connections 	Weight [kg]
<b>FN3258-7-44</b>		7 (7.7)	4	4.3	3.8	-44	0.5
<b>FN3258-16-44</b>		16 (17.5)	7.5	4.3	6.1	-44	0.8
<b>FN3258-30-33</b>		30 (32.9)	15	4.3	11.8	-33	1.2
<b>FN3258-42-33</b>		42 (46.0)	22	4.3	15.7	-33	1.4
<b>FN3258-55-34</b>		55 (60.2)	30	4.3	25.9	-34	2.0
<b>FN3258-75-34</b>		75 (82.2)	37	4.3	32.2	-34	2.7
<b>FN3258-100-35</b>		100 (109.5)	55	4.3	34.5	-35	4.3
<b>FN3258-130-35</b>		130 (142.4)	75	4.3	43.1	-35	4.5
<b>FN3258-180-40</b>		180 (197.1)	90	4.3	58.3	-40	6.0
<b>FN3258H-7-44</b>		7 (7.7)	4	4.7	3.8	-44	0.5
<b>FN3258H-16-44</b>		16 (17.5)	7.5	4.7	6.1	-44	0.8
<b>FN3258H-30-33</b>		30 (32.9)	18.5	4.7	11.8	-33	1.2
<b>FN3258H-42-33</b>		42 (46.0)	22	4.7	15.7	-33	1.4
<b>FN3258H-55-34</b>		55 (60.2)	37	4.7	25.9	-34	2.0
<b>FN3258H-75-34</b>		75 (82.2)	45	4.7	32.2	-34	2.7
<b>FN3258H-100-35</b>		100 (109.5)	55	4.7	34.5	-35	4.3
<b>FN3258H-130-35</b>		130 (142.4)	75	4.7	43.1	-35	4.5
<b>FN3258H-180-40</b>		180 (197.1)	110	4.7	58.3	-40	6.0

\* Calculated at rated current, 440 VAC (FN3258)/480 VAC (FN3258H) and cos phi=0.8. The exact value depends upon the efficiency of the drive, the motor and the entire application.

\*\* Standardized calculated leakage current acc. IEC60939 under normal operating conditions (FN3258 at 480 VAC and FN3258H at 520 VAC).

### Thermal Derating

If higher ambient temperatures than the specified apply, the nominal current needs to be reduced according to the graph below.

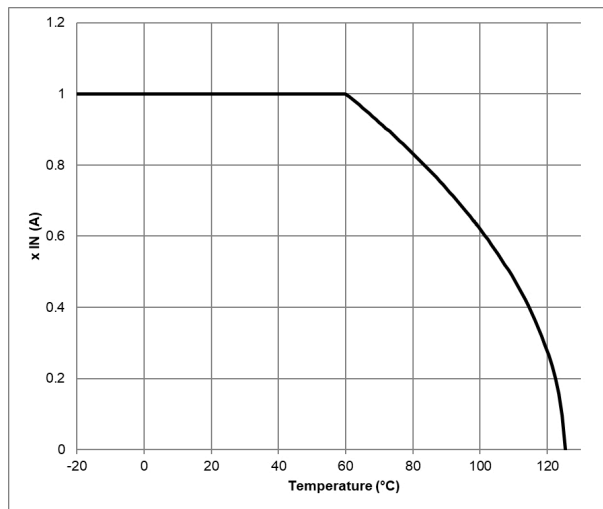

勝特力材料 886-3-5753170  
 勝特力电子(上海) 86-21-34970699  
 勝特力电子(深圳) 86-755-83298787  
[Http://www.100y.com.tw](http://www.100y.com.tw)

### Typical Filter Attenuation

Per CISPR 17; DM=50/50 sym; CM=50/50 asym

7 A type

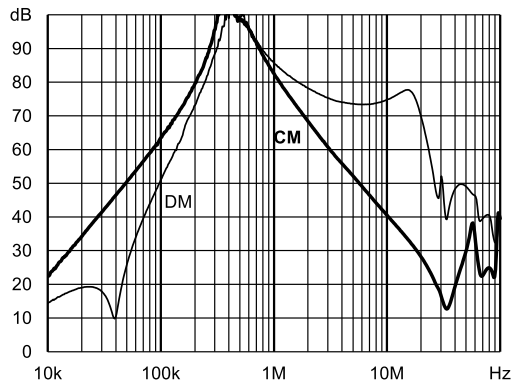

16 A type

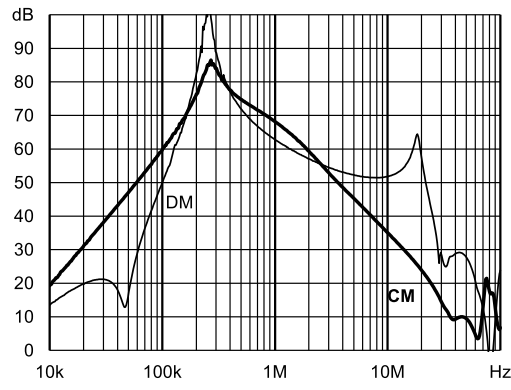

30 A type

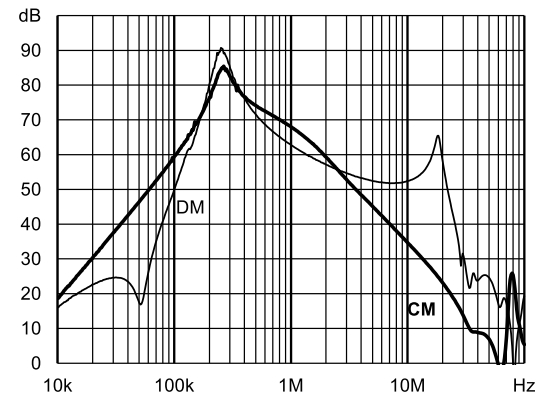

42 A type

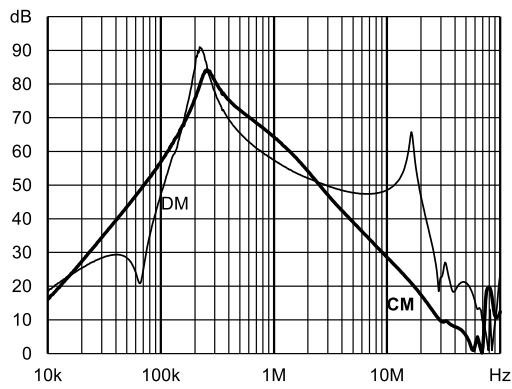

55 A type

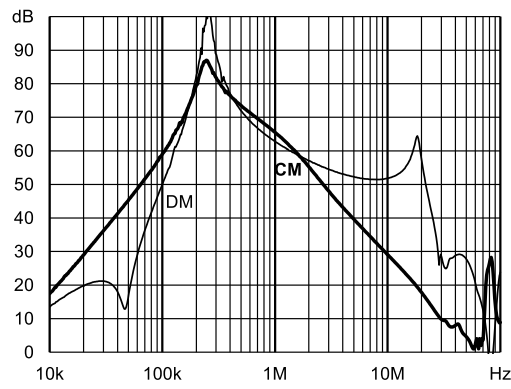

75 A type

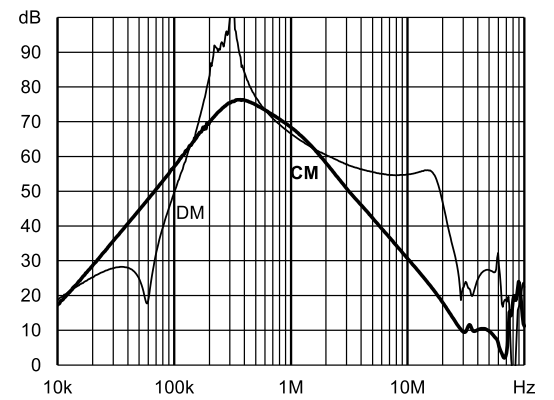

100 A type

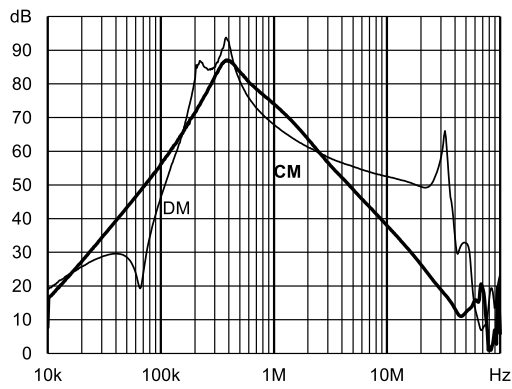

130 A type

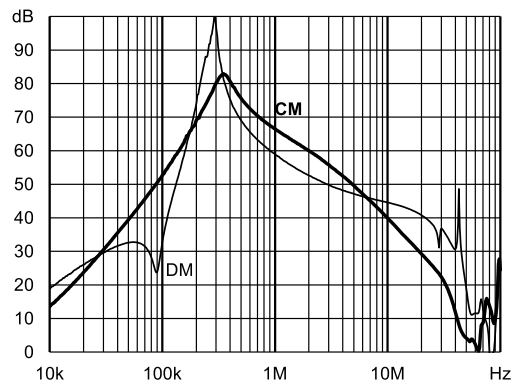

180 A type

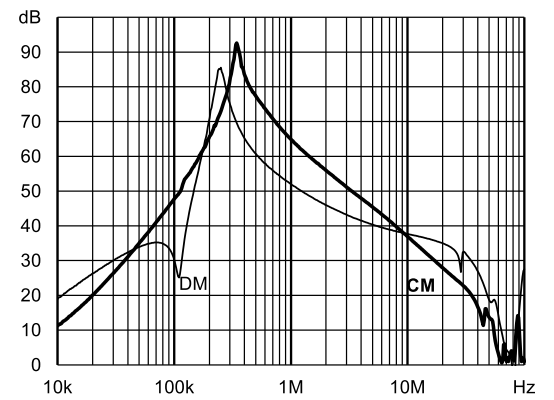

**勝特力材料 886-3-5753170**  
**勝特力电子(上海) 86-21-34970699**  
**勝特力电子(深圳) 86-755-83298787**  
[Http://www.100y.com.tw](http://www.100y.com.tw)

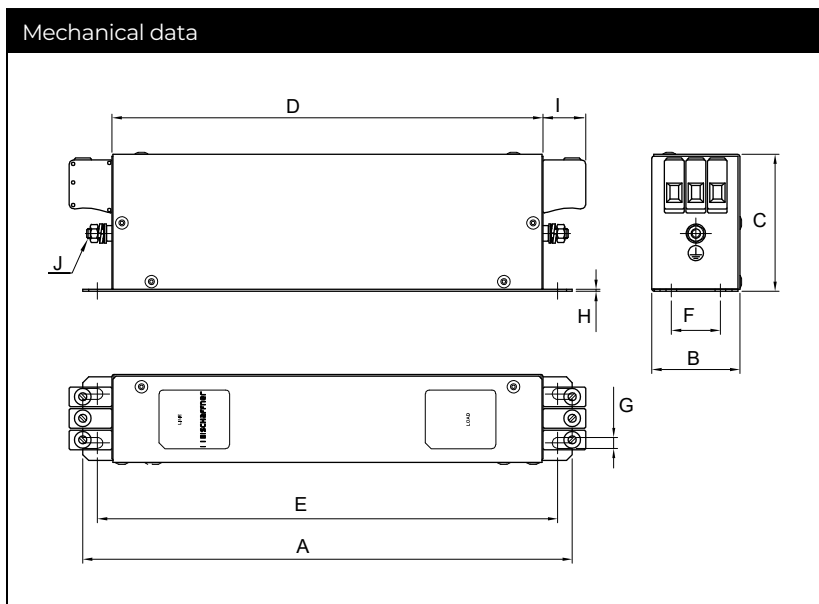

Note: in favour of a better readability, connectors and earth studs are not shown in the horizontal projection.

### Dimensions

	7 A	16 A	30 A	42 A	55 A	75 A	100 A	130 A	180 A
<b>A</b>	190	250	270	310	250	270	270	270	380
<b>B</b>	40	45	50	50	85	80	90	90	120
<b>C</b>	70	70	85	85	90	135	150	150	170
<b>D</b>	160	220	240	280	220	240	240	240	350
<b>E</b>	180	235	255	295	235	255	255	255	365
<b>F</b>	20	25	30	30	60	60	65	65	102
<b>G</b>	4.5	5.4	5.4	5.4	5.4	6.5	6.5	6.5	6.5
<b>H</b>	1	1	1	1	1	1.5	1.5	1.5	1.5
<b>I</b>	22	22	25	25	39	39	45	45	51
<b>J</b>	M5	M5	M5	M6	M6	M6	M10	M10	M10
<b>K</b>	20	22.5	25	25	42.5	40	45	45	60
<b>L2</b>	29.5	29.5	39.5	37.5	26.5	70.5	64	64	47

All dimensions in mm; 1 inch = 25.4 mm  
Tolerances according: ISO 2768-m/EN 22768-m

### Filter Input/Output Connector Cross Sections

	-33	-34	-35	-40	-44
<b>Solid wire</b>	16 mm <sup>2</sup>	35 mm <sup>2</sup>	50 mm <sup>2</sup>	95 mm <sup>2</sup>	10 mm <sup>2</sup>
<b>Flex wire</b>	10 mm <sup>2</sup>	25 mm <sup>2</sup>	50 mm <sup>2</sup>	95 mm <sup>2</sup>	6 mm <sup>2</sup>
<b>AWG type wire</b>	AWG 6	AWG 2	AWG 1/0	AWG 4/0	AWG 8
<b>Recommended torque</b>	1.5-1.8 Nm	4.0-4.5 Nm	7-8 Nm	17-20 Nm	1.0-1.2 Nm

Please visit [www.schaffner.com](http://www.schaffner.com) to find more details on filter connectors.

**勝特力材料 886-3-5753170**  
**勝特力电子(上海) 86-21-34970699**  
**勝特力电子(深圳) 86-755-83298787**  
**Http://www.100y.com.tw**