

Multi-stage Performance AC/DC EMI Filter



- Rated currents from 1 to 36 A
- High differential and common-mode attenuation
- High frequency attenuation
- Optional medical versions (B type)
- Optional safety versions (A type)



Approvals & Compliances



Features and Benefits

- FN2070 two-stage filters are designed for easy and fast chassis mounting
- FN2070 B versions without capacitors to earth comply to 1MOP for ME (medical equipment) acc. IEC 60601-1
- FN2070 A version with low capacitance to earth for safety critical applications with necessity for low leakage currents
- All filters provide a high conducted attenuation performance, based on chokes with high saturation resistance and excellent thermal behavior
- FN2070 two-stage filters are designed for high frequency attenuation
- FN2070 filters are also available as single-stage filters (FN2030 series)
- FN2070 filters are also available with differential mode choke (FN2080 series)
- Various terminal options allow you to select the desired connection style

Technical Specifications

Rated voltage*	250 VAC, 50/60 Hz; 250 VDC
Operating frequency	DC to 400 Hz
Rated currents	1 to 36 A @ 40°C max
High potential test voltage	P → PE 2000 VAC for 2 sec P → PE 2500 VAC for 2 sec (B types) P → N 1100 VDC for 2 sec
Temperature range (operation and storage)	-25°C to +100°C (25/100/21)**
Certified to	UL 1283, CSA 22.2 No. 8 1986, IEC/EN 60939 (applies to AC and DC applications)
Flammability corresponding to	Laces for -07 version: UL 94 VW-1 Terminal plastic for -06/-08 version: UL 94 V-0 Grommet for -07 version: UL 94V-0
Design corresponding to	UL 1283, CSA 22.2 No. 8 1986, IEC/EN 60939
Overvoltage category	II acc. IEC 60664-1
Pollution degree	2 acc. IEC 60664-1
Altitude	2000m (above derating applies)**
MTBF @ 40°C/230 V (Mil-HB-217F)	1,550,000 hours 1,600,000 hours (B types)

- * maximum RMS operating voltage at rated frequency or the maximum DC operating voltage
 ** for dedicated requests exceeding this specification (e.g. -40 °C or higher altitude) please contact your local Schaffner Sales office

勝特力材料 886-3-5753170
 勝特力电子(上海) 86-21-34970699
 勝特力电子(深圳) 86-755-83298787
[Http://www.100y.com.tw](http://www.100y.com.tw)

Typical Applications

- Electrical and electronic equipment
- Consumer goods
- Household equipment
- Building automation
- Industrial applications
- Machinery
- Medical equipment
- Electronic data processing equipment
- Office automation and datacom equipment
- Various noisy applications requiring good filter performance
- Single Phase Motor Drives

Typical electrical schematic

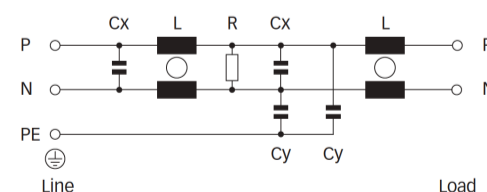

Filter Selection Table

Filter*	Buy	Rated current @ 40°C (25°C) [A]	Leakage current** @ 250 VAC/50 Hz (@ 120 VAC/60 Hz) [mA]	Power Loss @25°C/DC [W]	Inductance*** L [mH]	Capacitance***		Resistance*** R [kΩ]	Input/Output connections			Weight [g]
						Cx [μF]	Cy [nF]					
FN2070-1-..		1 (1.2)	0.66 (0.38)	2.4	22	0.33	4.7	1000	-06	-07		190
FN2070-3-..		3 (3.5)	0.66 (0.38)	2.2	9.8	0.47	4.7	470	-06	-07		250
FN2070-6-..		6 (6.9)	0.66 (0.38)	3.2	7.8	1	4.7	220	-06	-07		450
FN2070-10-..		10 (11.5)	0.66 (0.38)	9.1	4.5	1	4.7	220	-06	-07	-08	670
FN2070-12-..		12 (13.8)	0.66 (0.38)	13.1	3.25	1	4.7	220	-06	-07	-08	670
FN2070-16-..		16 (18.4)	0.66 (0.38)	9.6	2.8	1	4.7	220	-06	-07	-08	1000
FN2070-25-08		25 (28.8)	0.66 (0.38)	11.6	2	2.2	4.7	220			-08	760
FN2070-36-08		36 (41.4)	0.66 (0.38)	13.1	1.23	2.2	4.7	220			-08	790
FN2070A-1-..		1 (1.2)	0.07 (0.04)	2.4	22	0.33	0.47	1000	-06	-07		190
FN2070A-3-..		3 (3.5)	0.07 (0.04)	2.2	9.8	0.47	0.47	470	-06	-07		250
FN2070A-6-..		6 (6.9)	0.07 (0.04)	3.2	7.8	1	0.47	220	-06	-07		450
FN2070A-10-..		10 (11.5)	0.07 (0.04)	9.1	4.5	1	0.47	220	-06	-07	-08	670
FN2070A-12-..		12 (13.8)	0.07 (0.04)	13.1	3.25	1	0.47	220	-06	-07	-08	670
FN2070A-16-..		16 (18.4)	0.07 (0.04)	9.6	2.8	1	0.47	220	-06	-07	-08	1000
FN2070A-25-08		25 (28.8)	0.07 (0.04)	11.6	2	2.2	0.47	220			-08	760
FN2070A-36-08		36 (41.4)	0.07 (0.04)	13.1	1.23	2.2	0.47	220			-08	790
FN2070B-1-..		1 (1.2)	0.00	2.4	22	0.33		1000	-06	-07		190
FN2070B-3-..		3 (3.5)	0.00	2.2	9.8	0.47		470	-06	-07		250
FN2070B-6-..		6 (6.9)	0.00	3.2	7.8	1		220	-06	-07		450
FN2070B-10-..		10 (11.5)	0.00	9.1	4.5	1		220	-06	-07	-08	670
FN2070B-12-..		12 (13.8)	0.00	13.1	3.25	1		220	-06	-07	-08	670
FN2070B-16-..		16 (18.4)	0.00	9.6	2.8	1		220	-06	-07	-08	1000
FN2070B-25-08		25 (28.8)	0.00	11.6	2	2.2		220			-08	760
FN2070B-36-08		36 (41.4)	0.00	13.1	1.23	2.2		220			-08	790
Enhanced performance												
FN2070M-1-06		1 (1.2)	3.69 (2.13)	2.4	22	0.33	47	1000	-06			170
FN2070M-3-06		3 (3.5)	3.69 (2.13)	2.2	9.8	0.47	47	470	-06			250
FN2070M-6-06		6 (6.9)	3.69 (2.13)	3.2	7.8	1	47	220	-06			450
FN2070M-10-..		10 (11.5)	3.69 (2.13)	9.1	4.5	1	47	220	-06		-08	670
FN2070M-12-..		12 (13.8)	3.69 (2.13)	13.1	3.25	1	47	220	-06		-08	670
FN2070M-16-..		16 (18.4)	3.69 (2.13)	9.6	2.8	1	47	220	-06		-08	1000
FN2070M-25-08		25 (28.8)	3.69 (2.13)	11.6	2	2.2	47	220			-08	750
FN2070L-36-08		36 (41.4)	2.59 (1.49)	13.1	1.23	2.2	33	220			-08	790

* To compile a complete part number, please replace the .. with the required I/O connection style (e.g. FN 2070-25-08, FN 2070B-10-06).
 ** Maximum leakage under usual AC operating conditions (acc. IEC60939-3). Note: if the neutral line is interrupted, worst case leakage could reach twice this level.
 *** Tolerances apply: Inductance: -30/+50%, Capacitance: ±20%, Resistance: ±10%

勝特力材料 886-3-5753170
勝特力电子(上海) 86-21-34970699
勝特力电子(深圳) 86-755-83298787
[Http://www.100y.com.tw](http://www.100y.com.tw)

Typical Filter Attenuation

Per CISPR 17; CM=50 Ω/50 Ω sym; DM=50 Ω/50 Ω asym;

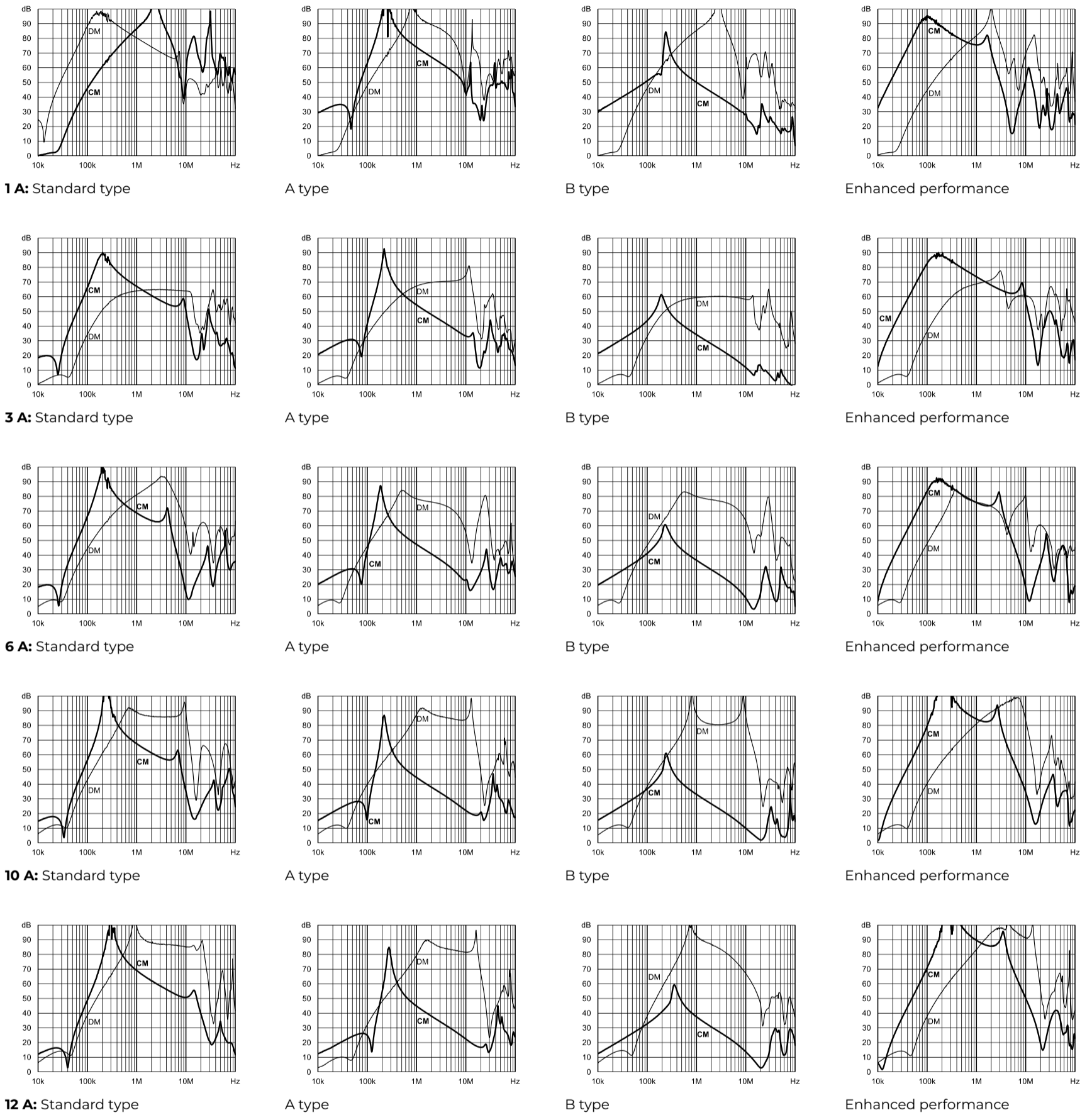

勝特力材料 886-3-5753170
勝特力电子(上海) 86-21-34970699
勝特力电子(深圳) 86-755-83298787
[Http://www.100y.com.tw](http://www.100y.com.tw)

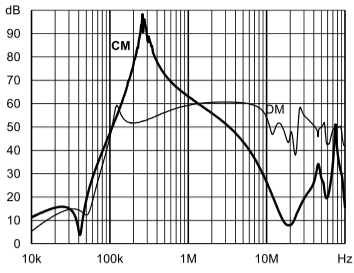

16 A: Standard type

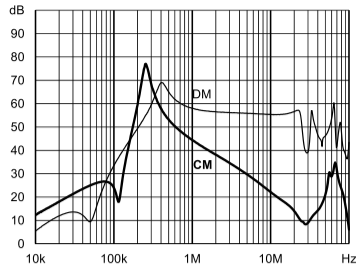

A type

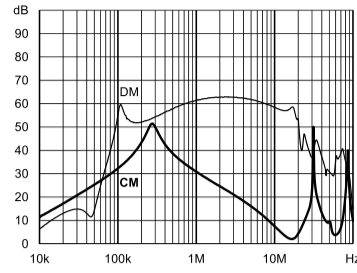

B type

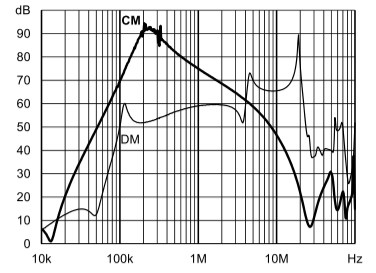

Enhanced performance

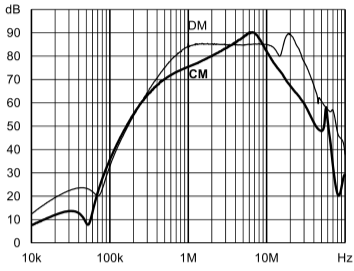

25 A: Standard type

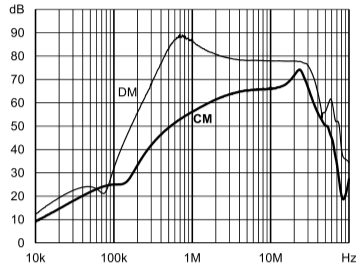

A type

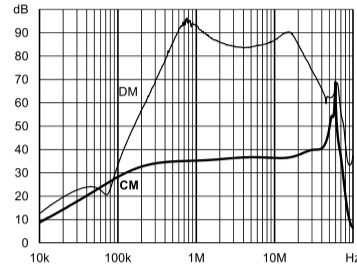

B type

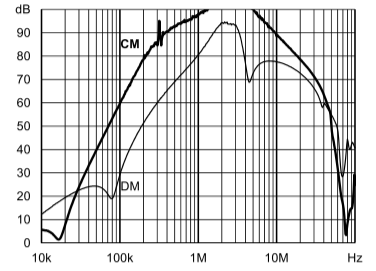

Enhanced performance

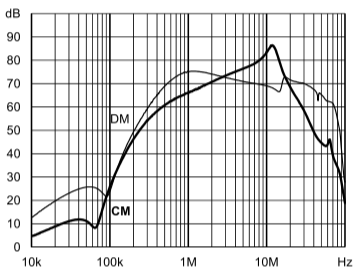

36 A: Standard type

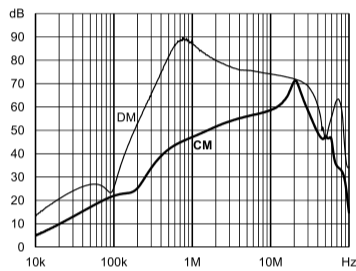

A type

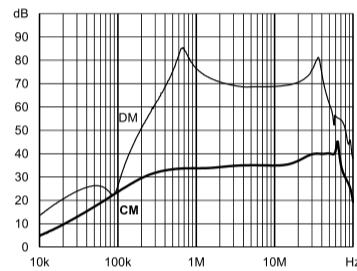

B type

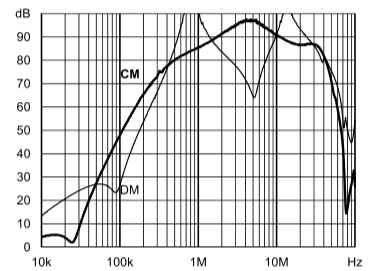

Enhanced performance

勝特力材料 886-3-5753170
 勝特力电子(上海) 86-21-34970699
 勝特力电子(深圳) 86-755-83298787
[Http://www.100y.com.tw](http://www.100y.com.tw)

Product selector

FN 2070 x -xx-yy

06	Faston 6.3 × 0.8 mm (spade/soldering)
07	Wire leads
08	Studs (M4 screws)
1 to 36	Rated current
Blank	Standard version
A	Safety version
B	Medical version
L/M	High performance version

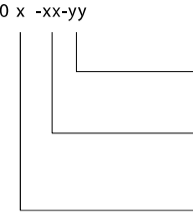

勝特力材料 886-3-5753170
勝特力电子(上海) 86-21-34970699
勝特力电子(深圳) 86-755-83298787
[Http://www.100y.com.tw](http://www.100y.com.tw)

Mechanical Data

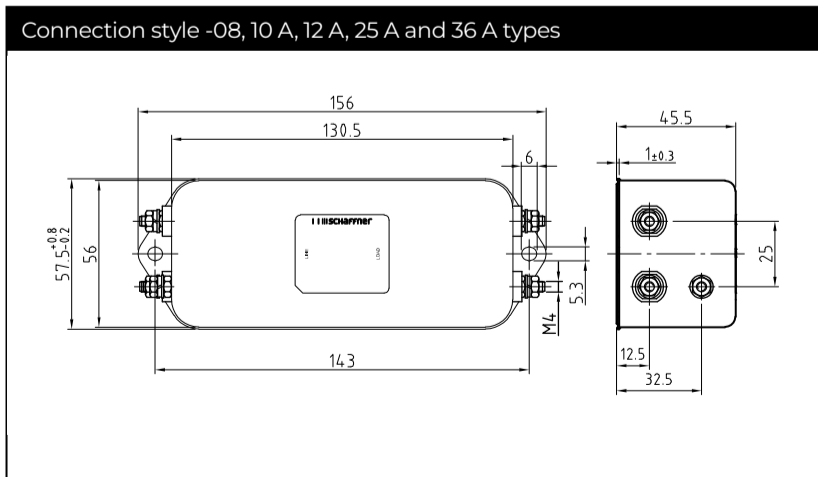
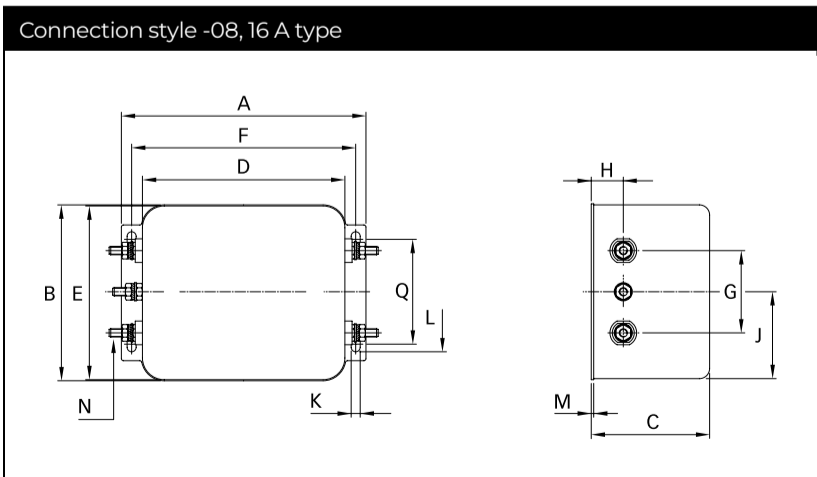
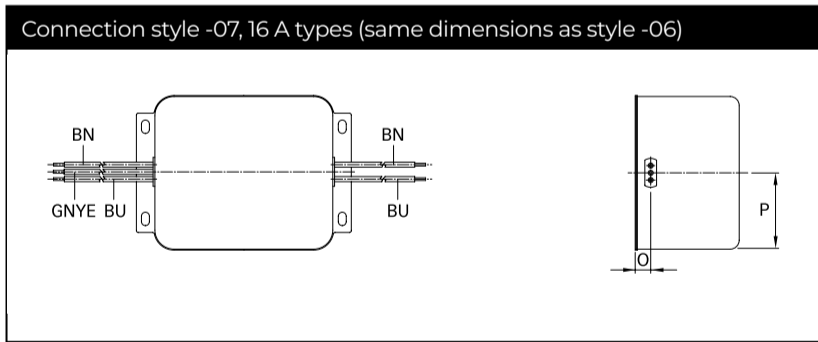
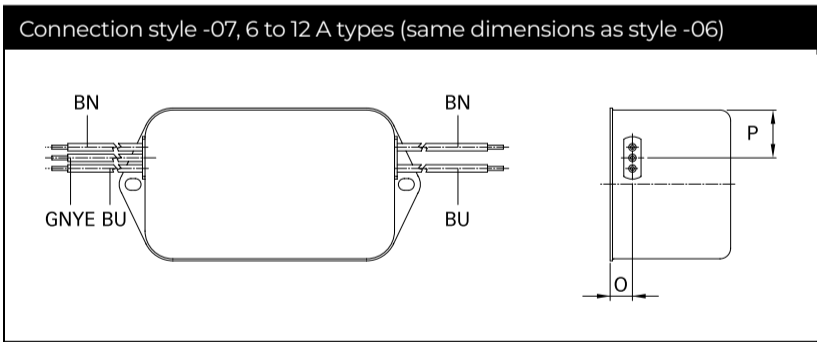
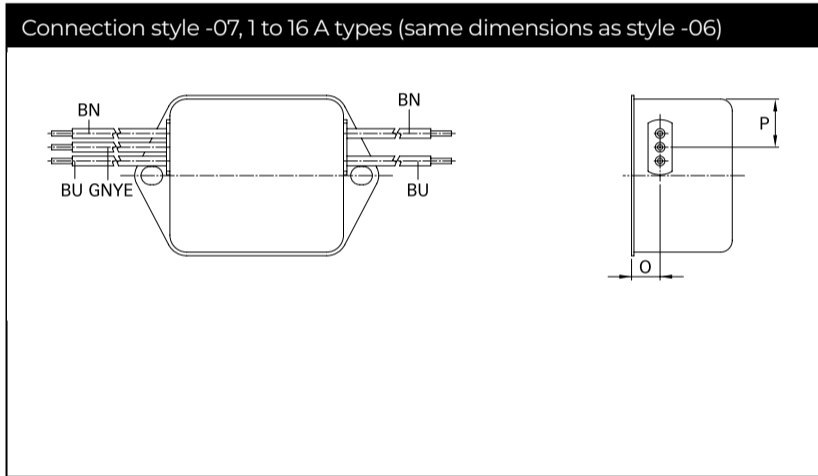
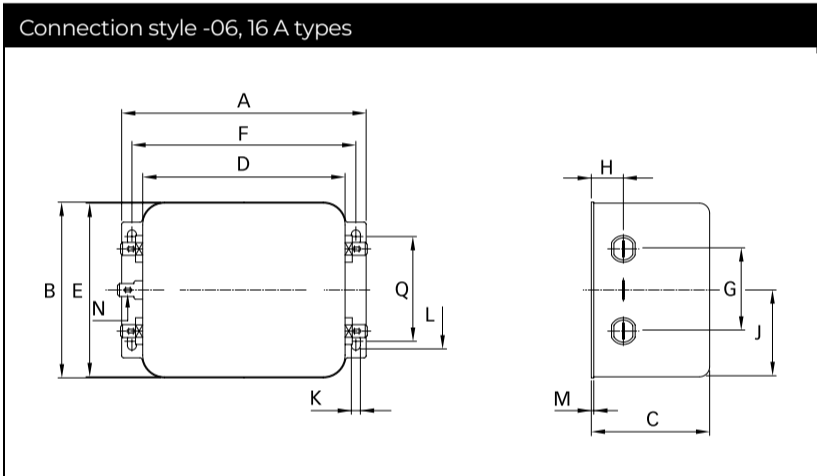
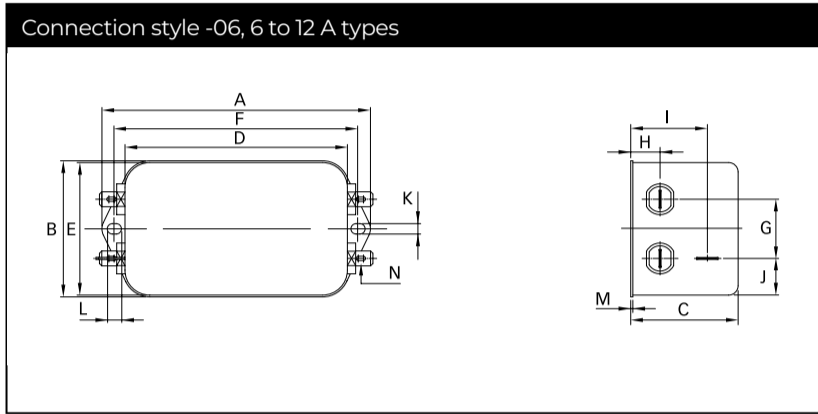
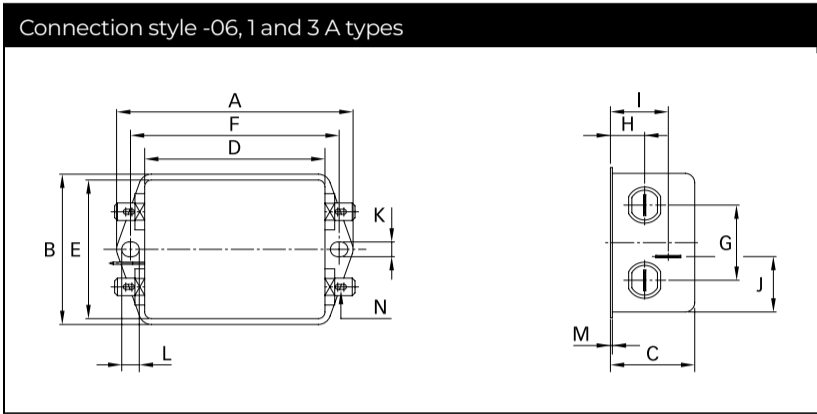

Dimensions

	1 A	3 A	6 A	10 A	12 A	16 A	25 A	36 A	Tolerances
A	85 ±0.5	85 ±0.5	113.5	156	156	119	156	156	±1
B	54 ±0.5	54 ±0.5	57.5	57.5	57.5	85.5	57.5	57.5	±1
C	30.3 ±0.5	40.3 ±0.5	45.4	45.4	45.4	57.6	45.4	45.4	±1
D	64.8 ±0.5	64.8 ±0.5	94	130.5	130.5	98.5	130.5	130.5	±1
E	49.8	49.8	56	56	56	84.5	56	56	±0.5
F	75	75	103	143	143	109	143	143	±0.3
G	27	27	25	25	25	40	25	25	±0.2
H	12.3	12.3	12.4	12.4	12.4	15.6	12.4	12.4	±0.5
I	20.8	29.8	32.4	32.5	32.5		32.5	32.5	±0.5
J	19.9	11.4	15.5	15.5	15.5	42.25	15.5	15.5	±0.5
K	5.3	5.3	4.4	5.3	5.3	4.4	5.3	5.3	
L	6.3	6.3	6	6	6	7.4	6	6	
M	0.7	0.7	1	1	1	1.2	1	1	±0.3
Connection style -06									
N	6.3 x 0.8	6.3 x 0.8	6.3 x 0.8	6.3 x 0.8	6.3 x 0.8	6.3 x 0.8			
Connection style -07									
O	8.3	8.3	8.4	8.4	8.4	8.6			±0.5
P	14.9	14.9	18	18	18	42.25			±0.5
AWG type wire	AWG 20	AWG 20	AWG 18	AWG 18	AWG 16	AWG 16			
Wire length	140	140	140	140	140	140			+5
Connection style -08									
N				M4	M4	M4	M4	M4	
Q						51			±0.2
Recommended torque (Nm)				1.2 - 1.3	1.2 - 1.3	1.2 - 1.3	1.2 - 1.3	1.2 - 1.3	
Earth terminal				1.5 - 1.7	1.5 - 1.7	1.5 - 1.7	1.5 - 1.7	1.5 - 1.7	

All dimensions in mm; 1 inch = 25.4 mm

Please visit www.schaffner.com to find more details on filter connections.

勝特力材料 886-3-5753170
勝特力电子(上海) 86-21-34970699
勝特力电子(深圳) 86-755-83298787
Http://www.100y.com.tw