

General Purpose AC/DC EMI Filter

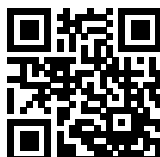

Images are for reference only. Please see product specifications

- Rated currents from 1 to 60 A
- General purpose filtering performance
- Optional medical versions (B type)
- Optional safety versions (A type)
- Optional enhanced performance versions
- Optional DC optimized versions



Performance indicators

Attenuation performance



Rated current [A]

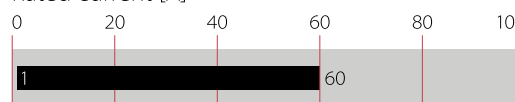

勝特力材料 886-3-5753170
 勝特力电子(上海) 86-21-34970699
 勝特力电子(深圳) 86-755-83298787
[Http://www.100y.com.tw](http://www.100y.com.tw)

Technical Specifications

Rated voltage*	250 VAC, 50/60 Hz 250 VDC
Operating frequency	DC to 400 Hz
Flammability corresponding to	Laces for -07 version: UL 94 VW-1 Terminal plastic for -06/-08 version: UL 94 V-0 Grommet for -07 version: UL 94 V-0
Overvoltage category	II acc. IEC 60664-1
Pollution degree	2 acc. IEC 60664-1
Altitude	2000m (above derating applies)**
Rated currents	1 to 60 A @ 40°C max.
High potential test voltage	P → N 1100 VDC for 2 sec P → PE 2000 VAC for 2 sec (equiv. cap <88 nF) P → PE 2550 VDC for 2 sec (equiv. cap >88 nF) P → PE 2500 VAC for 2 sec (B types)
Temperature range (operation and storage)	-25 °C to +100 °C (25/100/21)**
Certified to	UL 1283, CSA 22.2 No. 8 1986, IEC/EN 60939 (applies to AC and DC applications)

* maximum RMS operating voltage at rated frequency or the maximum DC operating voltage
 ** for dedicated requests exceeding this specification (e.g. -40 °C or higher altitude) please contact your local Schaffner sales office

Approvals & Compliances



Features and Benefits

- FN 2010 filters are designed for easy and fast chassis mounting
- FN 2010 B versions without capacitors to earth comply to 1MOP for ME (medical equipment) acc. IEC 60601-1
- FN 2010 A versions with low capacitance to earth for safety critical applications with necessity for low leakage currents
- FN 2010 filters are also available as enhanced performance and DC optimized versions. With higher attenuation in very compact housing (M, N1,N types)
- All filters provide a general purpose conducted attenuation performance, based on chokes with high saturation resistance and excellent thermal behavior
- FN 2010 filters can be used to cover a broad range of usage and they offer a good size/amperage ratio
- Various terminal options allow you to select the desired connection style



Typical Applications

- Electrical and electronic equipment
- Consumer goods
- Household equipment
- Medical equipment
- Office automation equipment
- Datacom equipment

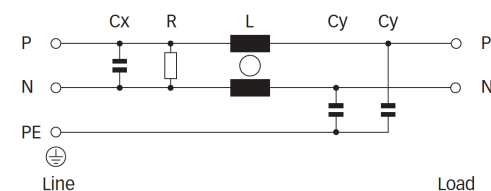
Typical electrical schematic



Filter Selection Table

Filter*	Buy	Rated current @ 40°C (25°C) [A]	Leakage current** @ 250 VAC/50 Hz (@ 120 VAC/60 Hz) [mA]	Power loss @25°C/DC [W]	Inductance*** L		Capacitance*** Cx Cy		Resistance*** R [kΩ]	Input/Output connections			Weight [g]
					[mH]	[μF]	[nF]						
FN2010-1-..		1 (1.15)	0.66 (0.38)	0.8	12	0.1	4.7	1000	-06	-07		65	
FN2010-3-..		3 (3.45)	0.66 (0.38)	1.1	2.5	0.1	4.7	1000	-06	-07		65	
FN2010-6-..		6 (6.9)	0.66 (0.38)	1.7	1	0.1	4.7	1000	-06	-07		65	
FN2010-10-..		10 (11.5)	0.66 (0.38)	2.5	0.8	0.1	4.7	1000	-06	-07		85	
FN2010-12-..		12 (13.8)	0.66 (0.38)	3.6	0.7	0.1	4.7	1000	-06	-07		85	
FN2010-16-..		16 (18.4)	0.66 (0.38)	2.5	0.7	0.1	4.7	1000	-06	-07	-08	140	
FN2010-20-..		20 (23)	0.66 (0.38)	3.8	0.6	0.1	4.7	1000	-06	-07	-08	210	
FN2010-30-08		30 (34.5)	0.79 (0.46)	6.3	0.7	0.47	10	1000			-08	470	
FN2010-60-24		60 (69)	0.79 (0.46)	14.7	1	1.5	10	330			-24	1100	
FN2010A-1-..		1 (1.15)	0.07 (0.04)	0.8	12	0.1	0.47	1000	-06	-07		65	
FN2010A-3-..		3 (3.45)	0.07 (0.04)	1.1	2.5	0.1	0.47	1000	-06	-07		65	
FN2010A-6-..		6 (6.9)	0.07 (0.04)	1.7	1	0.1	0.47	1000	-06	-07		65	
FN2010A-10-..		10 (11.5)	0.07 (0.04)	2.5	0.8	0.1	0.47	1000	-06	-07		85	
FN2010A-12-..		12 (13.8)	0.07 (0.04)	3.6	0.7	0.1	0.47	1000	-06	-07		85	
FN2010A-16-..		16 (18.4)	0.07 (0.04)	2.5	0.7	0.1	0.47	1000	-06	-07	-08	140	
FN2010A-20-..		20 (23)	0.07 (0.04)	3.8	0.6	0.1	0.47	1000	-06	-07	-08	210	
FN2010A-30-08		30 (34.5)	0.07 (0.04)	6.3	0.7	0.47	0.47	1000			-08	470	
FN2010A-60-24		60 (69)	0.07 (0.04)	14.7	1	1.5	0.47	330			-24	1100	
FN2010B-1-..		1 (1.15)	0.00	0.8	12	0.1		1000	-06	-07		65	
FN2010B-3-..		3 (3.45)	0.00	1.1	2.5	0.1		1000	-06	-07		65	
FN2010B-6-..		6 (6.9)	0.00	1.7	1	0.1		1000	-06	-07		65	
FN2010B-10-..		10 (11.5)	0.00	2.5	0.8	0.1		1000	-06	-07		85	
FN2010B-12-..		12 (13.8)	0.00	3.6	0.7	0.1		1000	-06	-07		85	
FN2010B-16-..		16 (18.4)	0.00	2.5	0.7	0.1		1000	-06	-07	-08	140	
FN2010B-20-..		20 (23)	0.00	3.8	0.6	0.1		1000	-06	-07	-08	210	
FN2010B-30-08		30 (34.5)	0.00	6.3	0.7	0.47		1000			-08	470	
FN2010B-60-24		60 (69)	0.00	14.7	1	1.5		330			-24	1100	
Enhanced performance													
FN2010N1-1-06		1 (1.15)	5.34 (3.08)	0.8	12	0.1	68	1000	-06			70	
FN2010N1-3-06		3 (3.45)	5.34 (3.08)	1.1	2.5	0.1	68	1000	-06			70	
FN2010N1-6-06		6 (6.9)	5.34 (3.08)	1.7	1	0.1	68	1000	-06			70	
FN2010N1-10-06		10 (11.5)	5.34 (3.08)	2.5	0.8	0.1	68	1000	-06			85	
FN2010N1-12-06		12 (13.8)	3.69 (2.13)	3.6	0.7	0.1	47	1000	-06			85	
FN2010M-16-..		16 (18.4)	3.69 (2.13)	2.5	0.7	0.1	47	1000	-06		-08	140	
FN2010M-20-..		20 (23)	3.69 (2.13)	3.8	0.6	0.1	47	1000	-06		-08	220	
FN2010N-30-08		30 (34.5)	7.85 (4.52)	6.3	0.7	0.47	100	1000			-08	400	
FN2010N-60-24		60 (69)	7.85 (4.52)	14.7	1	1.5	100	330			-24	1120	

*** To compile a complete part number, please replace the -.. with the required I/O connection style (e.g. FN 2010-30-08, FN 2010B-10-06). The different letters code the used Cy values in the filter type (A = 0.47nF; M = 47nF; N1 = 47nF; N = 100nF)

*** Maximum leakage under usual AC operating conditions (acc. IEC 60939-3). Note: if the neutral line is interrupted, worst case leakage could reach twice this level.

*** Tolerances apply: Inductance: -30/+50%, Capacitance: ±20%, Resistance: ±10%

勝特力材料 886-3-5753170
 勝特力电子(上海) 86-21-34970699
 勝特力电子(深圳) 86-755-83298787
[Http://www.100y.com.tw](http://www.100y.com.tw)

Typical Filter Attenuation

Per CISPR 17: symmetrical 50 Ω/50 Ω -> Differential Mode (DM); asymmetrical 50 Ω/50 Ω -> Common Mode (CM)

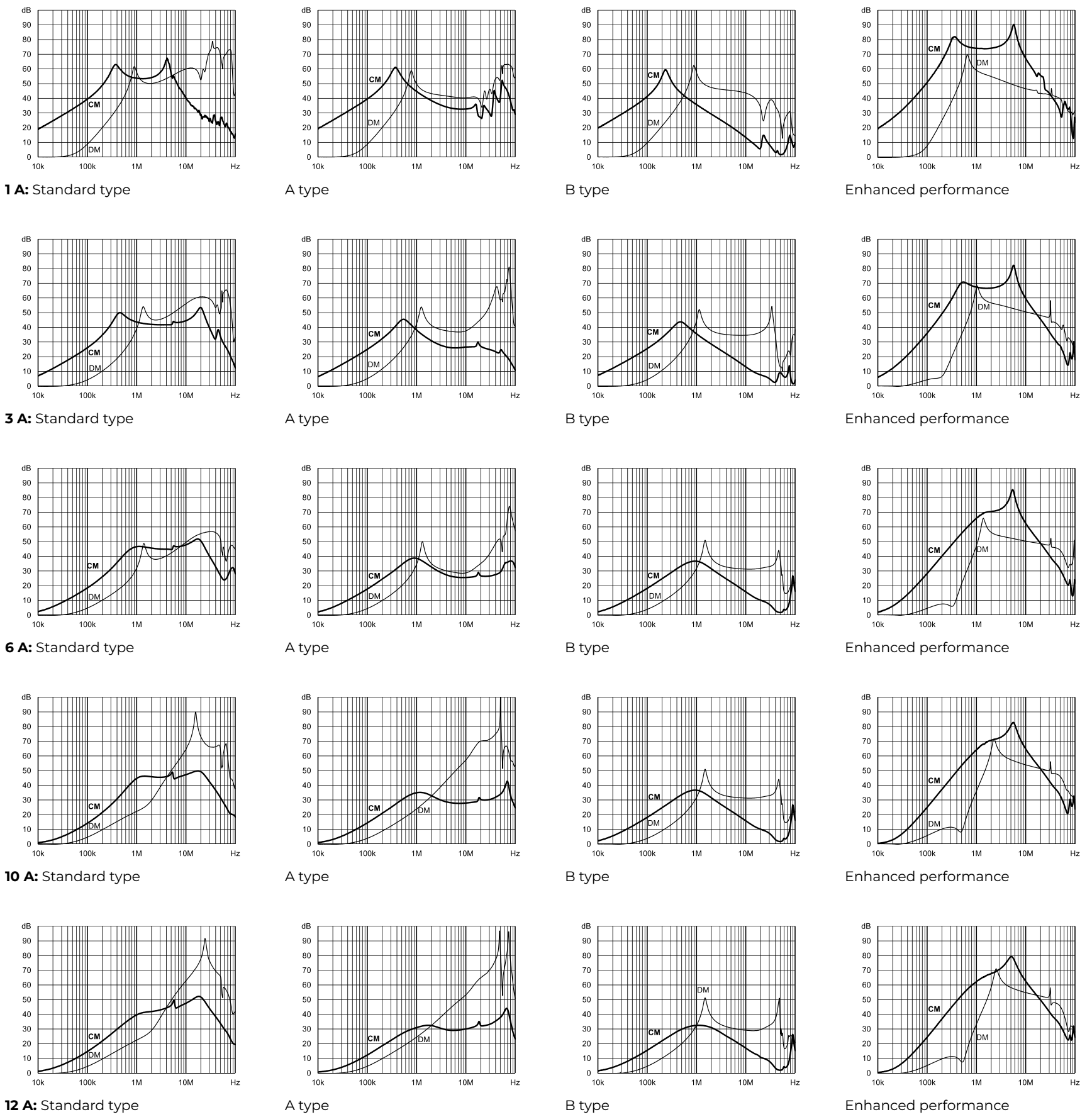

勝特力材料 886-3-5753170
 勝特力电子(上海) 86-21-34970699
 勝特力电子(深圳) 86-755-83298787
[Http://www.100y.com.tw](http://www.100y.com.tw)

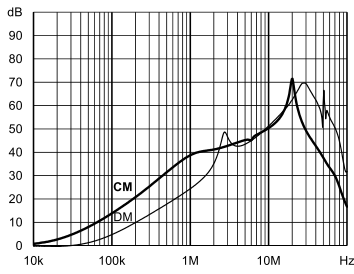

16 A: Standard type

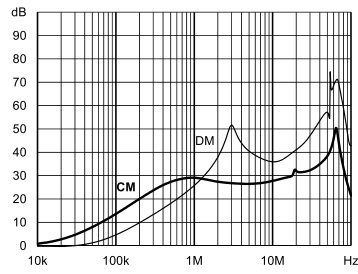

A type

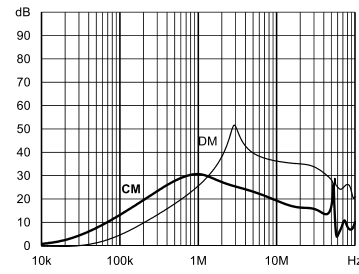

B type

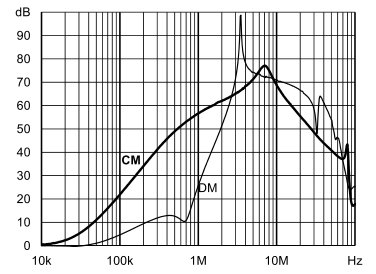

Enhanced performance

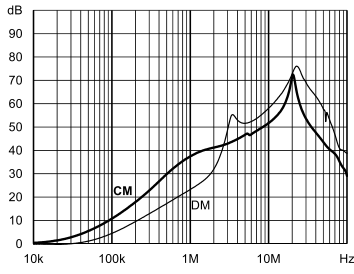

20 A: Standard type

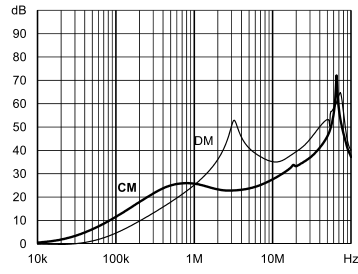

A type

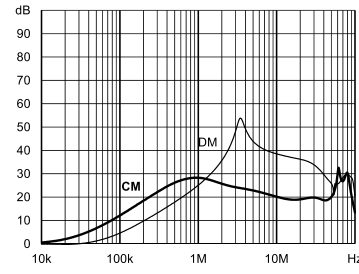

B type

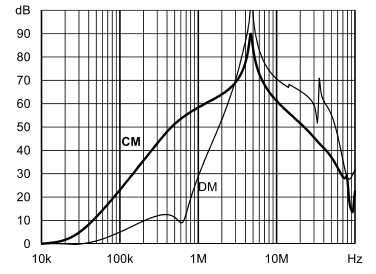

Enhanced performance

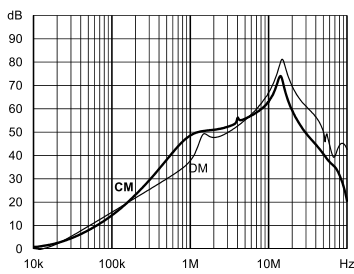

30 A: Standard type

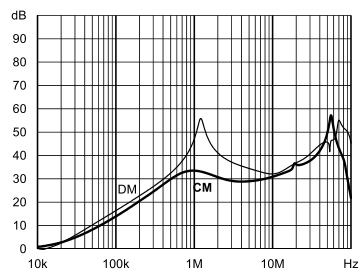

A type

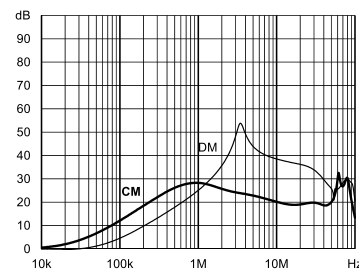

B type

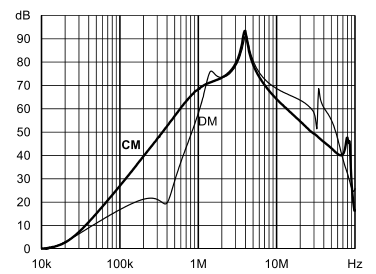

Enhanced performance

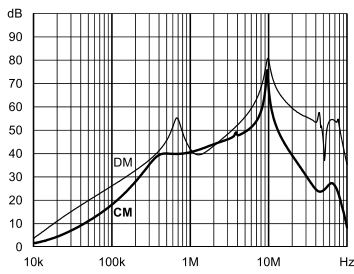

60 A: Standard type

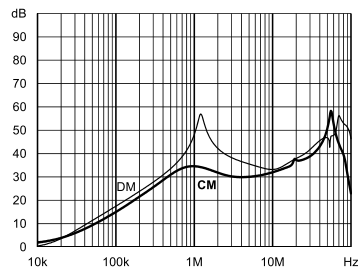

A type

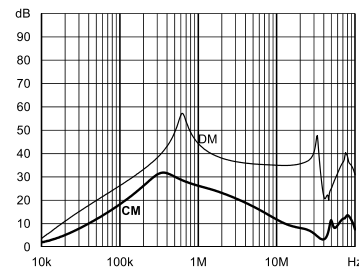

B type

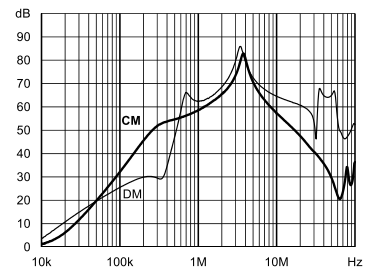

Enhanced performance

Product Selector		
FN 2010-xy-xx-yy		
	06	Faston 6.3 × 0.8 mm (spade/soldering)
	07	Wire leads
	08	Studs (M4 screws)
	24	Studs (M6 screws)
	1 to 60	Rated current
	Blank	Standard version
	Z	With surge protection
	Blank	Standard version
	A	Safety version
	B	Medical version
	N1/N/M	High performance version

勝特力材料 886-3-5753170
 勝特力电子(上海) 86-21-34970699
 勝特力电子(深圳) 86-755-83298787
[Http://www.100y.com.tw](http://www.100y.com.tw)

Mechanical Data

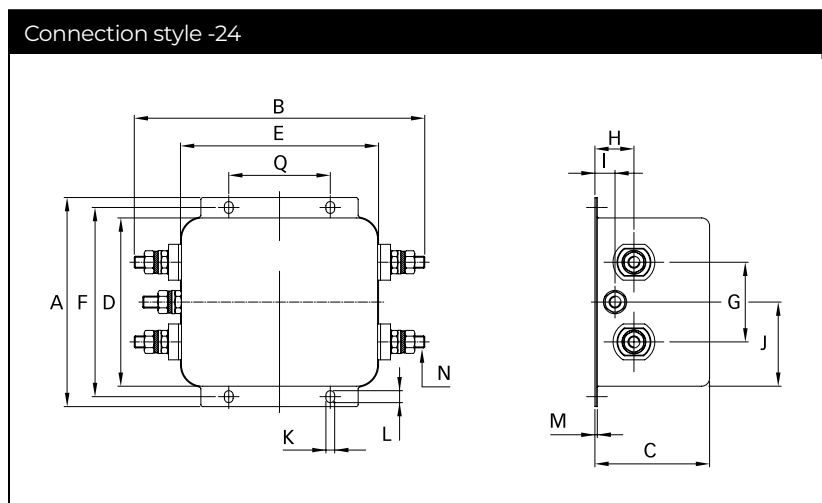
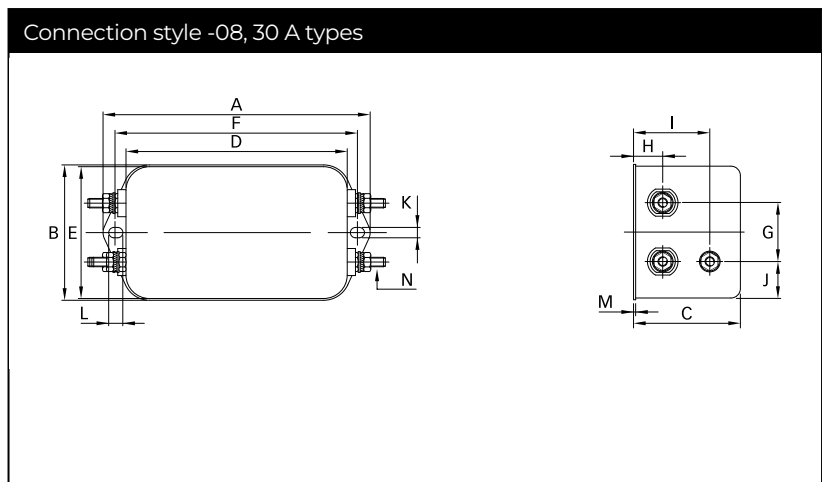
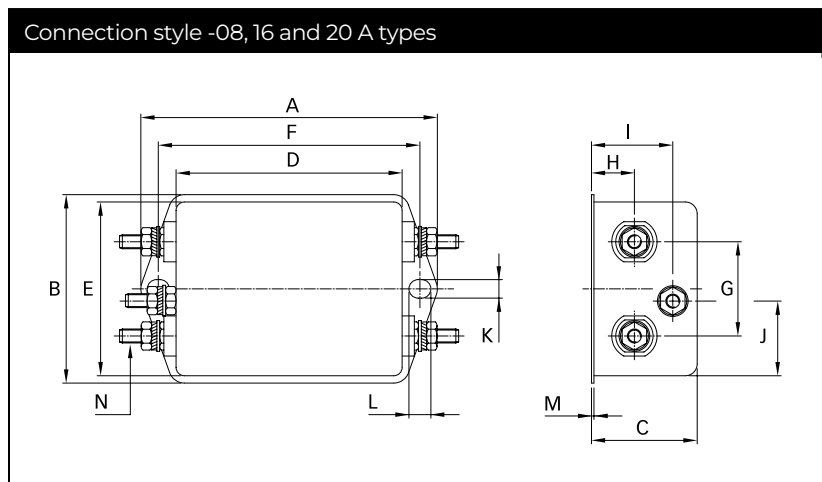
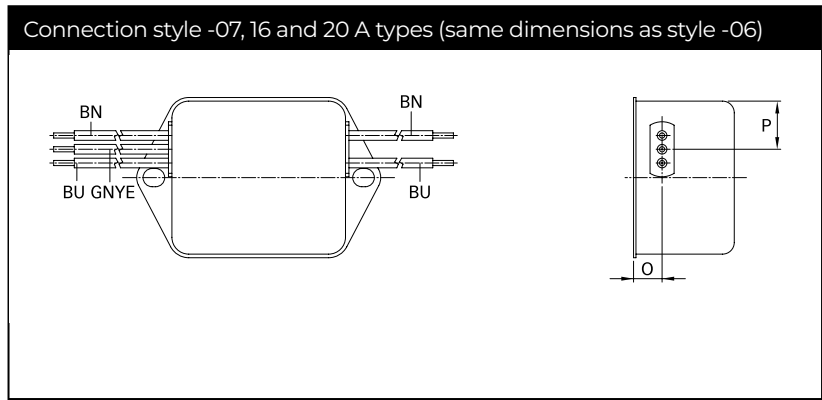
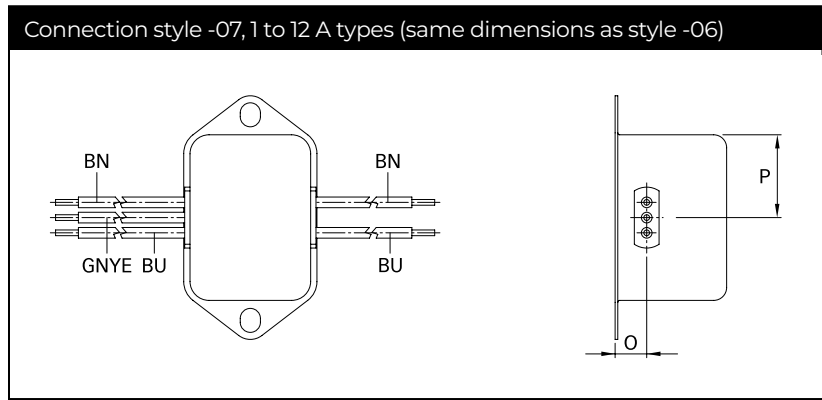
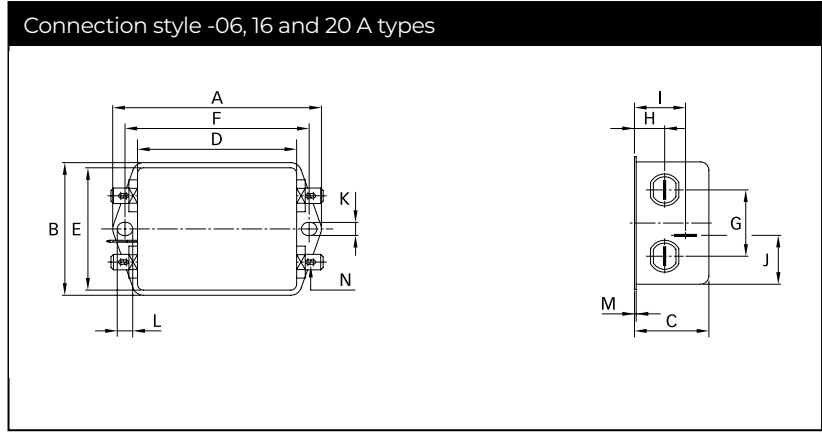
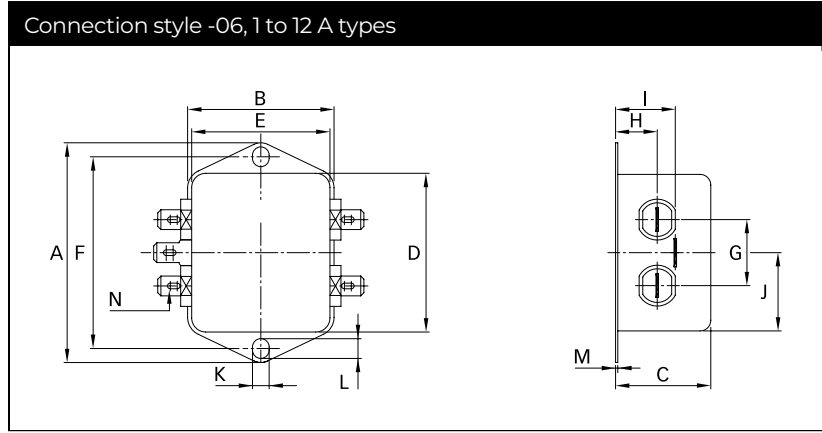

勝特力材料 886-3-5753170
 勝特力电子(上海) 86-21-34970699
 勝特力电子(深圳) 86-755-83298787
[Http://www.100y.com.tw](http://www.100y.com.tw)

Dimensions

	1 A	3 A	6 A	10 A	12 A	16 A	20 A	30 A	60 A	Tolerances
A	64	64	64	64	64	71	85	113.5 ±1	105 ±1	±0.5
B	35	35	35	35	35	46.6	54	57.5 ±1	145.9 ±1	±0.5
C	24.3	24.3	24.3	29.3	29.3	29.3	30.3	45.4 ±1	57.6 ±1	±0.5
D	43.5	43.5	43.5	43.5	43.5	50.5	64.8	94 ±1	84.5 ±1	±0.5
E	32.5	32.5	32.5	32.5	32.5	44.5	49.8	56	99.5	±0.5
F	54	54	54	54	54	61	75	103	95	±0.3
G	21	21	21	21	21	21	27	25	40	±0.2
H	9.3	9.3	9.3	9.3	9.3	10.8	12.3	12.4	19.6	±0.5
I	15.3	15.3	15.3	15.3	15.3	19.3	20.8	32.4	10.1	±0.5
J	21.8	21.8	21.8	21.8	21.8	20.1	19.9	15.5	42.25	±0.5
K	5.3	5.3	5.3	5.3	5.3	5.3	5.3	4.4	4.4	
L	6.3	6.3	6.3	6.3	6.3	6.3	6.3	6	6	
M	0.7	0.7	0.7	0.7	0.7	0.7	0.7	1	1.2	±0.3
Connection style -06										
N	6.3 x 0.8	6.3 x 0.8	6.3 x 0.8	6.3 x 0.8	6.3 x 0.8	6.3 x 0.8	6.3 x 0.8			
Connection style -07										
O	8.3	8.3	8.3	8.3	8.3	8.3	8.3			±0.5
P	21.8	21.8	21.8	21.8	21.8	14	14.9			±0.5
AWG type wire	AWG 20	AWG 20	AWG 18	AWG 18	AWG 16	AWG 16	AWG 14			
Wire length	140	140	140	140	140	140	140			+5
Connection style -08										
N						M4	M4	M4		
Recommended torque (Nm)						1.2 - 1.3	1.2 - 1.3	1.2 - 1.3		
Earth terminal						1.5 - 1.7	1.5 - 1.7	1.5 - 1.7		
Connection style -24										
N									M6	
Q									51	±0.2
Recommended torque (Nm)									3.5 - 4	
Earth Terminal									3.5 - 4	

All dimensions in mm; 1 inch = 25.4 mm

Tolerances according: ISO 2768-m/EN 22768-m

Please visit www.schaffner.com to find more details on filter connections.

勝特力材料 886-3-5753170
 勝特力电子(上海) 86-21-34970699
 勝特力电子(深圳) 86-755-83298787
[Http://www.100y.com.tw](http://www.100y.com.tw)