

勝特力電材超市-龍山店 886-3-5773766  
 勝特力電材超市-光復店 886-3-5729570  
 勝特力電子(上海) 86-21-34970699  
 勝特力電子(深圳) 86-755-83298787  
<http://www.100y.com.tw>

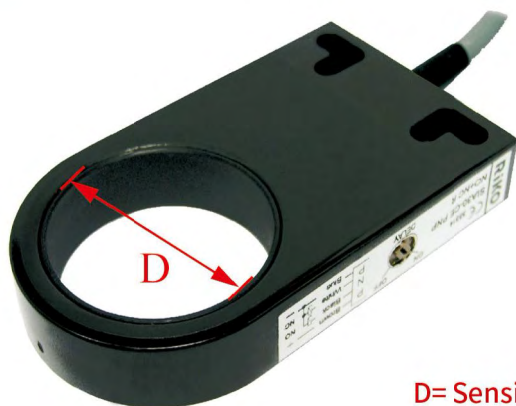

D= Sensing hole diameter (檢測孔直徑)

Model / 型號	NPN N.O./N.C.	SIA05-N	SIA12-N	SIA15-N	SIA22-N	SIA30-N
	PNP N.O./N.C.	SIA05-P	SIA12-P	SIA15-P	SIA22-P	SIA30-N
Sensing hole diameter / 檢測孔直徑		D=5mm	D=12mm	D=15mm	D=22mm	D=30mm
Min. detecting object / 最小檢測物		0.7mm min.	1.2mm min.	2mm min.	3mm min.	
Operating voltage / 工作電壓	DC 10 ~ 30V					
Current consumption / 消耗電流	15 mA					
Load current / 負載電流	100 mA Max. at DC 24V					
Operating temperature / 工作溫度	-20°C ~ + 60°C					
Protection degree / 防水等級	IP 65					
Wiring method / 出線方式	Ø4.2 x 2 M / 4 wires					
Recommended power unit / 應用電源供給單元	ST - 1 . ST - T2					
Weight / 重量	100g					

## Dimensions / 尺寸圖 (mm)

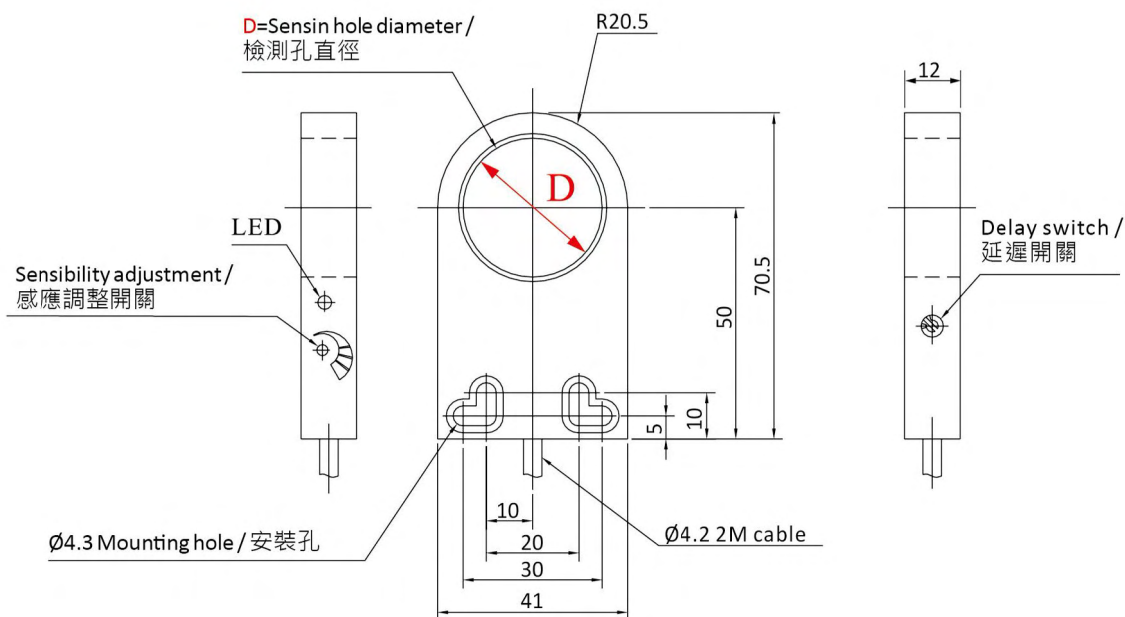

## Inductive Ring Sensor / 環型近接感應器

SIA series

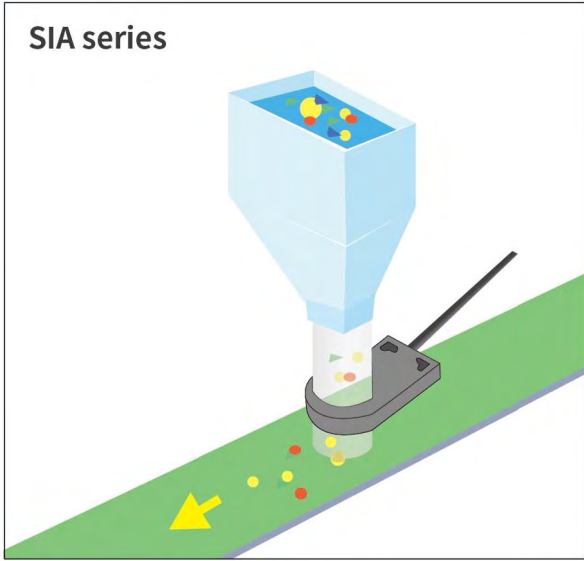

### Effects Of Metal In The Close Vicinity

If a moving metal part is closed to the sensing area the function can be disturbed. In order to avoid this, install the units some distance from metallic object. Ensure that this dose not away interfere the function.

### 金屬接近感應區域的影響

如果有移動的金屬零件靠近感應區域時，感應功能可能會被干擾。為了避免此情況發生，在裝置時，請與金屬物體保持一段距離，以確保不會干擾到感應功能。

### Selection Of Ring Sensor

Selection should be made based on the minimum hole diameter required. In this way the sensitivity adjustment can be made within normal parameters.

### 環型光電感應器的選擇

依據最小洞徑做選擇。如此敏銳性的調整可以在正常值內，而不會有不正當運作的風險。

Model	Length (mm)	Diameter (mm)
SIA05	1	0.7
SIA12	2	1.2
SIA44	9	5
SIA63	12	6
SIA100	20	12

## General Characteristics

In ring sensors, sensing is made within the ring itself. The sensors is activated when a metallic object is introduced within it. They are particularly suitable for applications where detection of small metal objects such as screws, nuts, washers etc...is requested and also for break detection of continuous metal wires that pass through it.

### 一般的特性

環型近接感應器的感應裝置就在其環形物中。當有金屬的物體通過此環形物時，感應器便產生作用。

特別適合用於檢測細小的金屬物體，例如螺絲釘、螺帽、墊圈等。以及連續金屬線的斷裂檢測。感應器的外罩是塑膠製。內徑為5、12、15、22、30、44、63、100 mm。

### Use With A Delayed Amplifiers

All types of ring sensors can work in combination with a delayed amplifier of the programmable ALTP series which ensures the sensing of small object in rapid movement.

### 與延遲輸出共同使用

所有形式的環型近接感應器，皆能用於可編程序的ALTP系列的延遲放大器，並可確保檢測快速移動的小物體。

### Use With A Delayed Amplifiers

A distance equal to the width of the sensor should be left between each objects that passes through the sensor. If more than one sensor is to be installed in close vicinity, the minimum distance indicated between sensors should be observed.

### 感應器的使用

通過感應器的每件物體，至少要有一個感應器寬度的間隔距離。如果超過一個以上的感應器，被裝置在鄰近區域，其相互間距離，必須遵守如附表所示的最小距離。

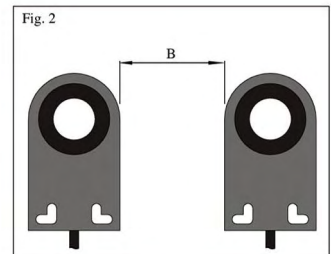
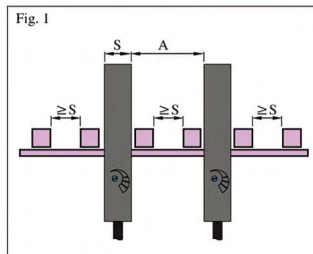

感應器間的最小距離					
Model	SIA05	SIA12	SIA44	SIA63	SIA100
A(Fig.1) mm	25	30	300	300	600
B(Fig.2) mm	10	10	250	250	650

## Sensitivity Adjustment

After having followed the instructions regarding the choice of the most suitable unit it is recommended that the sensitivity adjustment be carried out when the sensor is installed in the final position taking into account how much metal mass is close by which could alter its functioning. The sensitivity increases turning the trimmer clockwise.

### 靈敏度的調整

根據操作指南的指示，挑選最適合的型號後，強烈建議在最後安裝定位後，再做敏銳度的調整，並注意是否有任何的金屬物體會影響到它的正常功能。順時針方向旋轉可增加敏銳度。

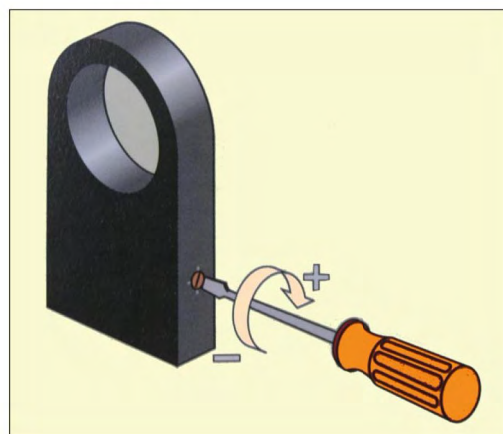

## Switching Frequency

The switch frequency of inductive ring sensors depends on delayed impulse time (when inserted) according to the formula:

$$\text{Switching frequency (Hz)} = \frac{1}{(T \text{ impulse} + 10) \text{ ms}}$$

Vice versa, switching frequency will be as per chart beside.

### 動作頻率

環型近接感應器的切換頻率取決於被測物通過時延遲的脈衝時間，並依據以下公式：

$$\text{切換頻率 (Hz)} = \frac{1}{(T \text{ 延遲輸出時間} + 10) \text{ ms}}$$

Model	開關動作頻率
SIA05	600~1500
SIA12	600~1000
SIA15	600~1000
SIA22	600~1000
SIA30	600~800
SIA44	250~600
SIA63	100~200
SIA100	≤100

## Delay On De-energization

All our inductive ring sensors, NPN and PNP amplified versions, are supplied with an ON-OFF switch to activate and deactivate delay on de-energization 100ms. This delay allows the sensor to detect small metallic objects passing rapidly through the sensitivity area of the ring.

### 延遲輸出

所有我們的環型近接感應器(NPN和PNP放大型式)都備有ON-OFF開關，以控制輸出供給的延遲100ms。這個延遲提供感應器能夠檢測出金屬小物體快速的通過感應區域。

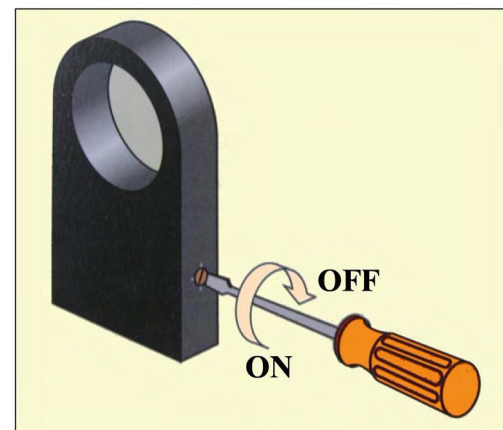

勝特力電材超市-龍山店 886-3-5773766  
 勝特力電材超市-光復店 886-3-5729570  
 勝特力電子(上海) 86-21-34970699  
 勝特力電子(深圳) 86-755-83298787  
<http://www.100y.com.tw>