

Laser Diode Sockets



- Compact miniature socket size for maximum board density
- Accommodates most any TO package format with pin circle options of .079" (2.0 mm) or .100" (2.54 mm), including popular laser diode devices
- 3 and 4 lead options available
- Funneled entry holes to assist lead insertion

勝特力材料 886-3-5753170
勝特力电子(上海) 86-21-34970699
勝特力电子(深圳) 86-755-83298787
[Http://www.100y.com.tw](http://www.100y.com.tw)

Date Issued: February 20, 2001

TS-0406-06
Sheet 1 of 3

Physical

Insulation

Material: Glass Filled Polysulfone
Flammability: UL 94V-0
Color: Green

Outer Contact

Material: Copper Alloy

Inner Contact

Material: Beryllium Copper
Plating: Outer Sleeve: SnPb Solder
Inner Contact: 30 μ m (0.76 μ m) Gold over 50 μ m (1.3 μ m) Nickel

Electrical

Current Rating: 1 Amp
Insulation Resistance: $> 1 \times 10^{12} \Omega$ at 500 Vdc
Withstanding Voltage: 1000 Vrms at Sea Level

Environmental

Operating Temperature Rating: - 55° C to + 150° C

3M Electronic Handling and Protection Division

6801 River Place Blvd.
Austin, TX 78726-9000

For technical, sales or ordering information call **800-328-0411**
or visit our website: <http://www.3M.com/ehpd>

Laser Diode Sockets

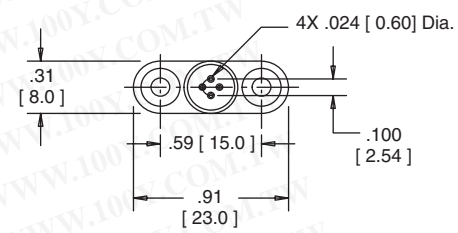
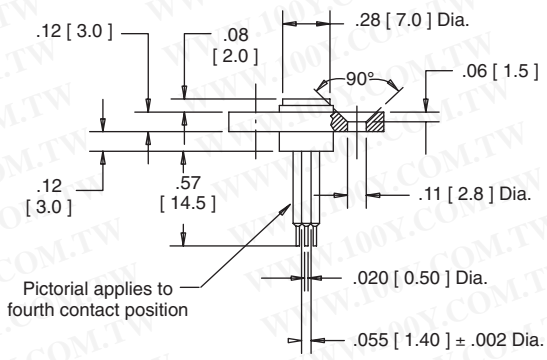

204-6585-00-0602J

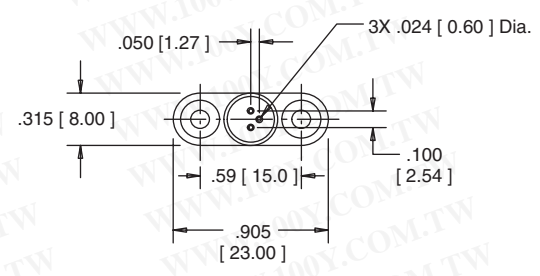

203-6585-00-0602J

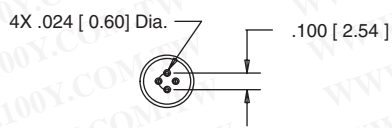
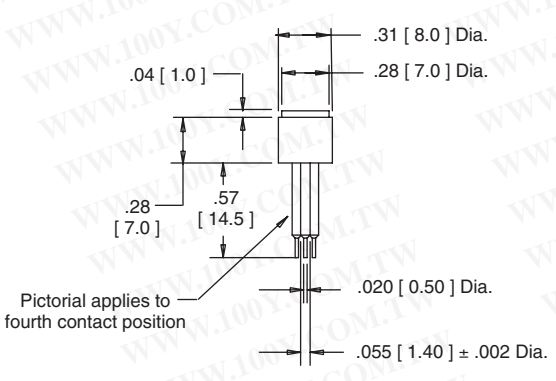

204-6585-50-0602J

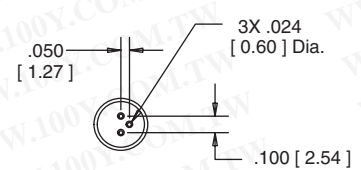

203-6585-50-0602J

Dimension	Tolerance	
	inch (.00)	mm (.00)
Tolerance	± .010 (± .25)	± .005 (± .13)

Ordering Information

Socket Part Number	Contact Qty.	Pin Circle	Mounting Flange
203-6585-00-0602J	3	.100 [2.54]	Yes
203-6585-50-0602J			No
203-6970-00-0602J		.079 [2.0]	Yes
203-6970-50-0602J			No
204-6585-00-0602J	4	.100 [2.54]	Yes
204-6585-50-0602J			No
204-6970-00-0602J		.079 [2.0]	Yes
204-6970-50-0602J			No

TS-0406-06
Sheet 2 of 3

Laser Diode Sockets

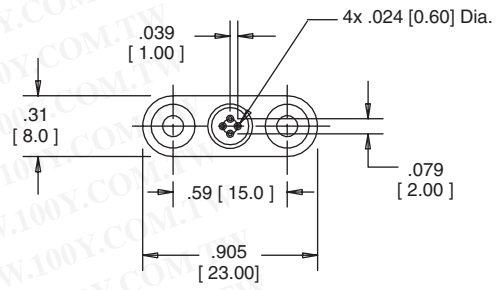
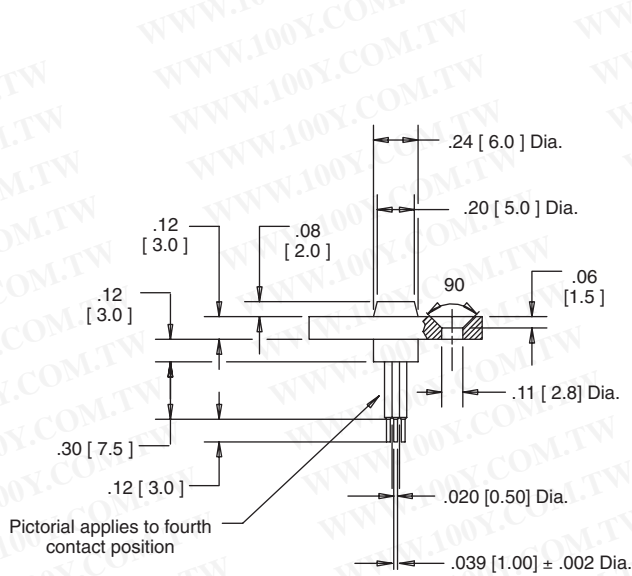

204-6970-00-0602J

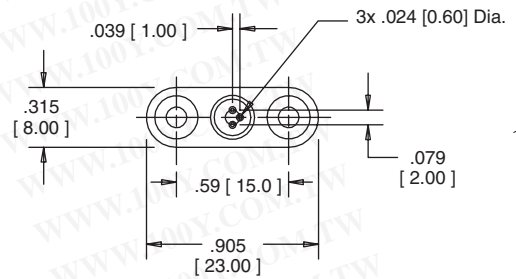

203-6970-00-0602J

Dimension	Tolerance $\frac{\text{inch}}{\text{(mm)}}$	
	.00 (.0)	.000 (.00)
Tolerance	± .010 (± .25)	± .005 (± .13)

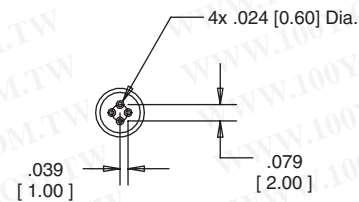
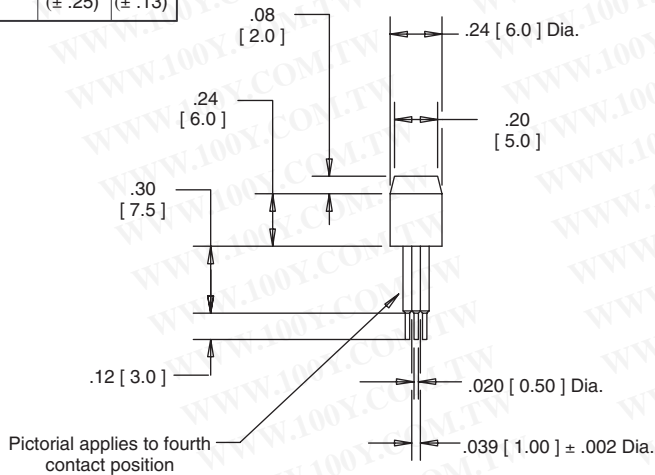

204-6970-50-0602J

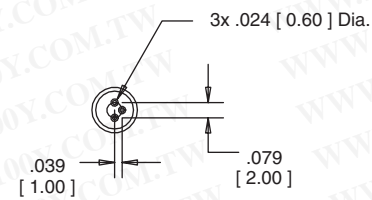

203-6970-50-0602J

勝特力材料 886-3-5753170
 勝特力电子(上海) 86-21-34970699
 勝特力电子(深圳) 86-755-83298787
[Http://www.100y.com.tw](http://www.100y.com.tw)

TS-0406-06
Sheet 3 of 3

3M Electronic Handling and Protection Division

6801 River Place Blvd.
Austin, TX 78726-9000

For technical, sales or ordering information call **800-328-0411**
or visit our website: <http://www.3M.com/ehpd>